

2023 MILLING TOOLS



About GESAC

Xiamen Golden Egret Special Alloy Co., Ltd. (GESAC), founded in 1989, is a Sino-foreign joint venture with national high-tech, affiliated with XTC, which is one of six major rare earth groups in China. GESAC is committed to research & development, production and professional solutions providing of high-quality tungsten powder materials, cemented carbide, precision cutting tools and other tungsten products. Up to now, GESAC has become world-famous manufacturer and supplier of tungsten powder, cemented carbide and precision cutting tools products.

With the Integrated Product Development of complete tungsten industry chain, as well as a pragmatic and innovative management concept, GESAC has always maintained a strong momentum of development, providing the cost effective tungsten powder products and services for global users, offering the excellent products and perfect solutions for solving high hardness, high temperature resistance and wear resistance topics. Our brand "Golden Egret" has become one of the leading brand in the market, enjoying famous reputation in more than 40 countries and regions.

GESAC owns four production headquarters and one national level research center domestically, and three sales branches and one production base overseas. We undertook and completed several development programs independently, including the "National Science and Technology Support Programs", the "National Torch Program Projects", and the "National Key Projects" and so on. GESAC was awarded as "Key Enterprise for Strategic Emerging Industry", "Innovative Enterprise" and "Enterprise with Advanced Technology".



Product Chain

GESAC has a complete tungsten product chain from tungsten ore to tungsten powder, cemented carbide products and cutting tools.

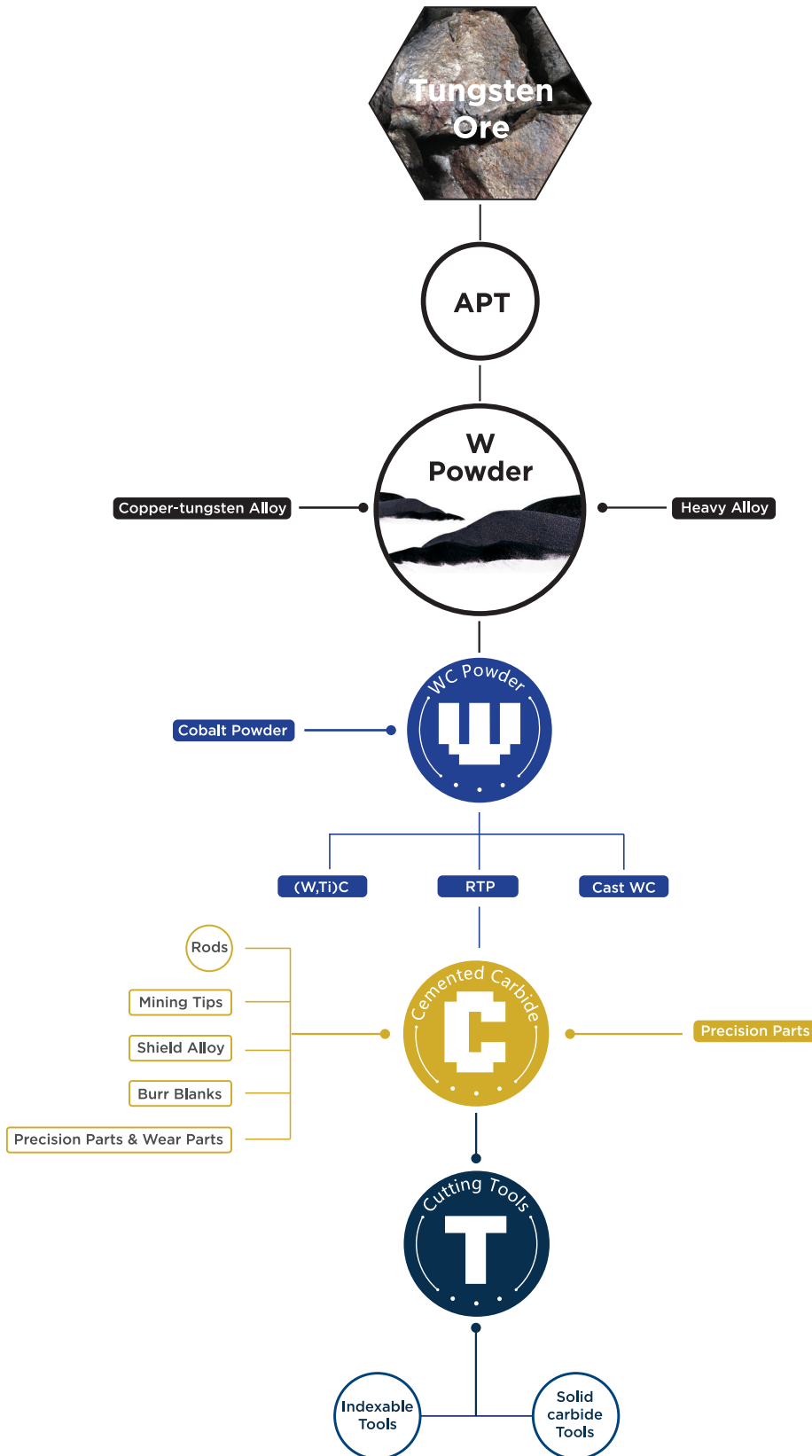



Contents

Indexable Milling Tool	A	Solid Carbide Endmills	B
Indexable Milling Tool Identification System	004	GESAC Coating	164
Series Introduction	008	Guidelines to Icons	167
Product Application Chart	017	Solid Carbide Endmill Identify System	168
Milling Insert Grade	029	Application Summary	174
Application of Milling Cutter with Different Pitch	034	Series Introduction	175
Face Milling •	035	Endmill Catalog (by Series)	182
Shoulder Milling •	079	Endmill Catalog (by Type)	208
Profile Milling •	119	Square •	208
High Feed Milling •	140	Corner Radius •	218
Slot Milling •	153	Ballnose •	224
Chamfer Milling •	160	Others •	230
		Solid Carbide Endmills	232
		Recommended Cutting Data	544
		Appendix	C
		Cutting Calculation and Definitions	638
		Workpiece Material Table	639
		The Standard of Shank	640
		Comparison Table of Hardness	641
		Spare Parts Specifications List	642

A

INDEXABLE MILLING CUTTER



ISO Milling Indexable Inserts Identification System

Symbol	Shape	Corner Angle	Figure
H	Hexagon	120°	
O	Octagon	135°	
P	Pentagon	108°	
S	Square	90°	
T	Triangle	60°	
C	Rhombic	80°	
D		55°	
E		75°	
F		50°	
M		86°	
V		35°	
W	Trigon	80°	
L	Rectangle	90°	
A	Parallelogram	85°	
B		82°	
K		55°	
R	Round	—	

① Shape Symbol

Symbol	Relief Angle
A	3°
B	5°
C	7°
D	15°
E	20°
F	25°
G	30°
N	0°
P	11°
O	Others



② Relief Angle Symbol

Symbol	Tolerance (mm)			Tolerance (inch)		
	Corner Height (m)	Thickness (s)	I.C. Size (Ød)	Corner Height (m)	Thickness (s)	I.C. Size (Ød)
A	±0.005	±0.025	±0.025	±0.0002	±0.001	±0.001
F	±0.005	±0.025	±0.013	±0.0002	±0.001	±0.0005
C	±0.013	±0.025	±0.025	±0.0005	±0.001	±0.001
H	±0.013	±0.025	±0.013	±0.0005	±0.001	±0.0005
E	±0.025	±0.025	±0.025	±0.001	±0.001	±0.001
G	±0.025	±0.13	±0.025	±0.001	±0.005	±0.001
J	±0.005	±0.025	±0.05~±0.13	±0.0002	±0.001	±0.002~±0.005
K	±0.013	±0.025	±0.05~±0.13	±0.0005	±0.001	±0.002~±0.005
L	±0.025	±0.025	±0.05~±0.13	±0.001	±0.001	±0.002~±0.005
M	±0.08~±0.18	±0.13	±0.05~±0.13	±0.003~±0.007	±0.005	±0.002~±0.005
N	±0.08~±0.18	±0.025	±0.05~±0.13	±0.003~±0.007	±0.001	±0.002~±0.005
U	±0.13~±0.38	±0.13	±0.08~±0.25	±0.005~±0.015	±0.005	±0.003~±0.01

③ Tolerance Symbol

① ② ③ ④ ⑤

S N E U 12

R D E T 12

① ② ③ ④ ⑤

④ Chipbreaker / Hole Symbol				
Symbol	Hole	Hole Shape	Chipbreaker	Shape
N	Without	—	Without	
R			Single-sided	
F			Double-sided	
A	With Hole	—	Without	
M			Single-sided	
G			Double-sided	
W			With hole and one countersink 40°-60°	Without
T	With hole and two countersinks 40°-60°	—	Single-sided	
Q			Without	
U	With hole and one countersink 70°-90°	—	Double-sided	
B			Without	
H	With hole and two countersinks 70°-90°	—	Single-sided	
C			Without	
J	With hole and two countersinks 70°-90°	—	Double-sided	
X			—	—

⑤ Cutting Edge Length Symbol (ISO) (mm)																
Symbol	Length	Symbol	Length	Symbol	Length	Symbol	Length	Symbol	Length	Symbol	Length	Symbol	Length	I.C. Size (mm)		
			03	3.97		03	4.0				06	6.9	4	4.8	3.97	
			04	4.76		04	4.8				08	8.2	5	5.8	4.76	
05	5	--	--	--	--	--	--	--	--	--	--	--	--	--	5	
		05	5.56	05	5.6	03	3.8	09	9.6	6	6.8				5.56	
06	6	--	--	--	--	--	--	--	--	--	--	--	--	--	6	
		06	6.35	06	6.5	04	4.3	11	11	7	7.8	11	11.2		6.35	
		07	7.94	08	8.1	05	5.4	13	13.8	9	9.7				7.94	
08	8	--	--	--	--	--	--	--	--	--	--	--	--	--	8	
09	9.525	09	9.525	09	9.7	06	6.5	16	16.5	11	11.6	16	16.6	16	19.7	9.525
10	10	--	--	--	--	--	--	--	--	--	--	--	--	--	10	
12	12	--	--	--	--	--	--	--	--	--	--	--	--	--	12	
12	12.7	12	12.7	12	12.9	08	8.7	22	22	15	15.5	22	22.1			12.7
15	15.875	15	15.875	16	16.1	10	10.9	27	27.5	19	19.4					15.875
16	16	--	--	--	--	--	--	--	--	--	--	--	--	--	16	
19	19.05	19	19.05	19	19.3	13	13	33	33	23	23.3					19.05
20	20	--	--	--	--	--	--	--	--	--	--	--	--	--	20	
		22	22.225	22	22.6					38	38.5	27	27.1			22.225
25	25	--	--	--	--	--	--	--	--	--	--	--	--	--	25	
25	25.4	25	25.4	25	25.8					44	44	31	31			25.4
31	31.75	31	31.75	32	32.2					55	55	38	38.8			31.75
31	32	--	--	--	--	--	--	--	--	--	--	--	--	--	32	

Insert Shape: H,O,P,S,T,C,E,M,W,R									
I.C. Size (mm)	Tolerance of I.C. Size(∅d) (mm)		Tolerance of Corner Height(m)(mm)		I.C. Size (inch)	Tolerance of I.C. Size(∅d) (mm)		Tolerance of Corner Height(m)(mm)	
	Class J,K,L,M,N	Class U	Class J,K,L,M,N	Class U		Class J,K,L,M,N	Class U	Class J,K,L,M,N	Class U
6.35	±0.05	±0.08	±0.08	±0.13	0.250	±0.002	±0.003	±0.003	±0.005
9.525					0.375				
12.7	±0.08	±0.13	±0.13	±0.2	0.500	±0.003	±0.005	±0.005	±0.008
15.875					0.625				
19.05	±0.1	±0.18	±0.15	±0.27	0.750	±0.004	±0.007	±0.006	±0.011
25.4					1.000				
31.75	±0.13	±0.25	±0.18	±0.38	1.250	±0.005	±0.010	±0.007	±0.015
32					1.260				

Symbol	Thickness (mm)
01	1.59
T1	1.98
02	2.38
T2	2.78
03	3.18
T3	3.97
04	4.76
05	5.56
06	6.35
07	7.94
09	9.52
©Thickness Symbol	

Insert Shape: D					
Inscribed Circle Size		Tolerance of I.C. Size		Tolerance of Corner Height	
mm	inch	mm	inch	mm	inch
6.35	0.250	±0.05	±0.002	±0.11	±0.004
9.525	0.375	±0.05	±0.002	±0.11	±0.004
12.7	0.500	±0.08	±0.003	±0.15	±0.006
15.875	0.625	±0.10	±0.004	±0.18	±0.007
19.05	0.750	±0.10	±0.004	±0.18	±0.007

Insert Shape: V					
Inscribed Circle Size		Tolerance of I.C. Size		Tolerance of Corner Height	
mm	inch	mm	inch	mm	inch
6.35	0.250	±0.05	±0.002	±0.15	±0.006
9.525	0.375	±0.05	±0.002	±0.15	±0.006
12.7	0.500	±0.08	±0.003	±0.20	±0.008
15.875	0.625	±0.10	±0.004	±0.27	±0.011
19.05	0.750	±0.10	±0.004	±0.27	±0.011

⑥

⑦

⑧

⑨

⑩

06 AN E N - GM
 04 MO T - MM

⑥

⑦

⑧

⑨

⑩

D. Theoretical Diameter of Inscribed Circle

S. Insert Thickness

M. See Fig.

⑦ Wiper Angle or Nose Radius						
I			II			
Symbol	Approach Angle	Cutting Edge Angle	Symbol	Relief Angle of Wiper	Symbol	Corner- R_e (mm)
A	45°	45°	A	3°	M0	circular inserts
D	30°	60°	B	5°	00	0.03
E	15°	75°	C	7°	02	0.2
F	5°	85°	D	15°	04	0.4
P	0°	90°	E	20°	08	0.8
Z	Others		F	25°	12	1.2
			G	30°	16	1.6
			N	0°	20	2.0
			P	11°	24	2.4
			Z	Others	28	2.8
					32	3.2

⑧ Major Cutting Edge		
Symbol	Description	Shape
F	Sharp Edge	
E	R-Honed	
T	Chamfer	
S	Chamfer and R-Honed	

⑨ Direction		
Symbol	Hand	Shape
R	Right	
L	Left	
N	Neutral	

⑩ Chipbreaker Symbol	
Symbol	Machining Condition
GL	General Lighting Cutting
GM	General Medium Cutting
GH	General Heavy Cutting
PL	Light Cutting for Steel
PM	Medium Cutting for Steel
PR	Rough Cutting for Steel
KM	Medium Cutting for Cast Iron
KR	Rough Cutting for Cast Iron
MM	Medium Cutting for Stainless Steel
W*	Wiper Cutting
NL/AL	Lighting Cutting for Nonferrous Metal
.....	

Milling Cutter Holder Identification System

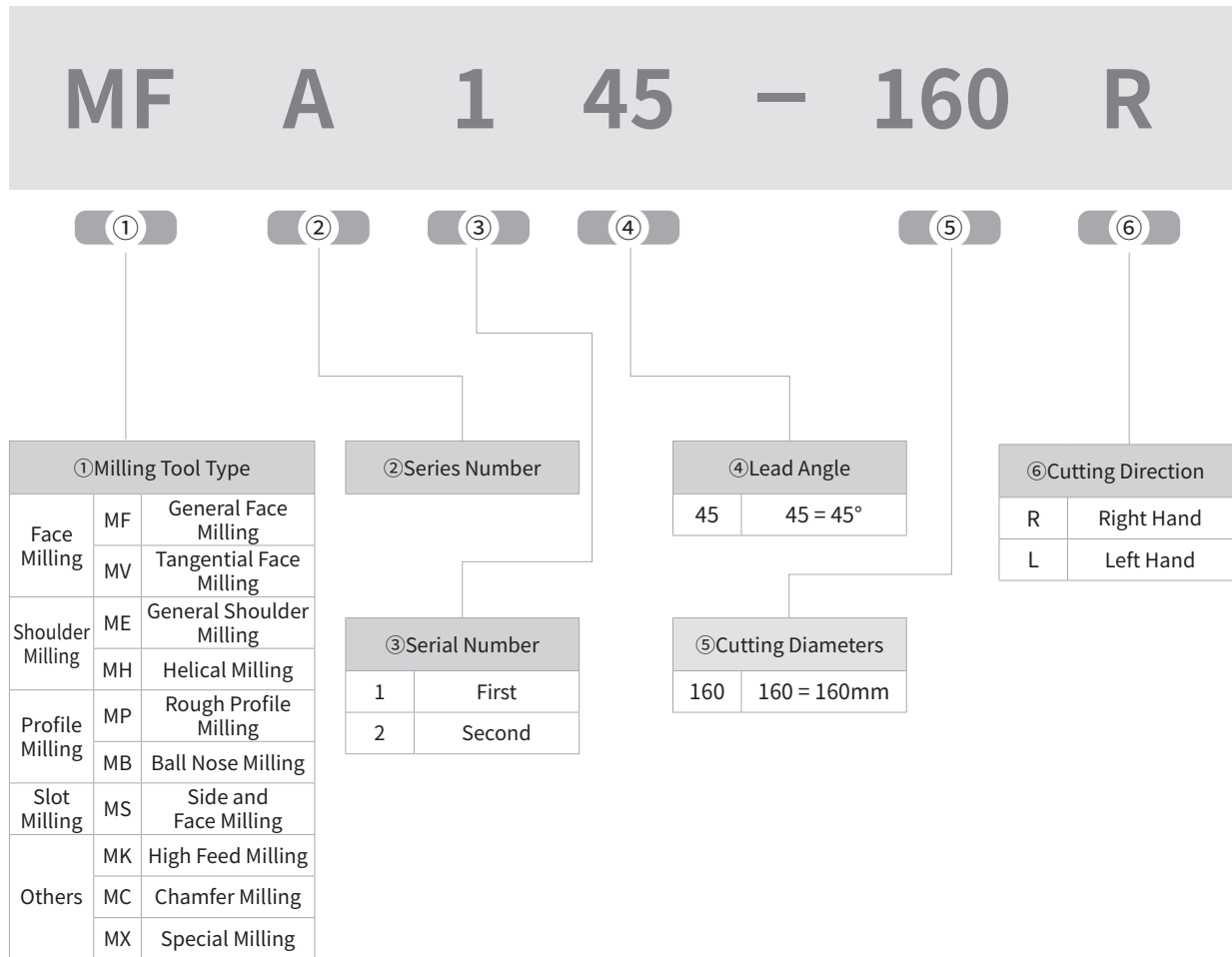

09 C 40 (T) S E 13 (M)

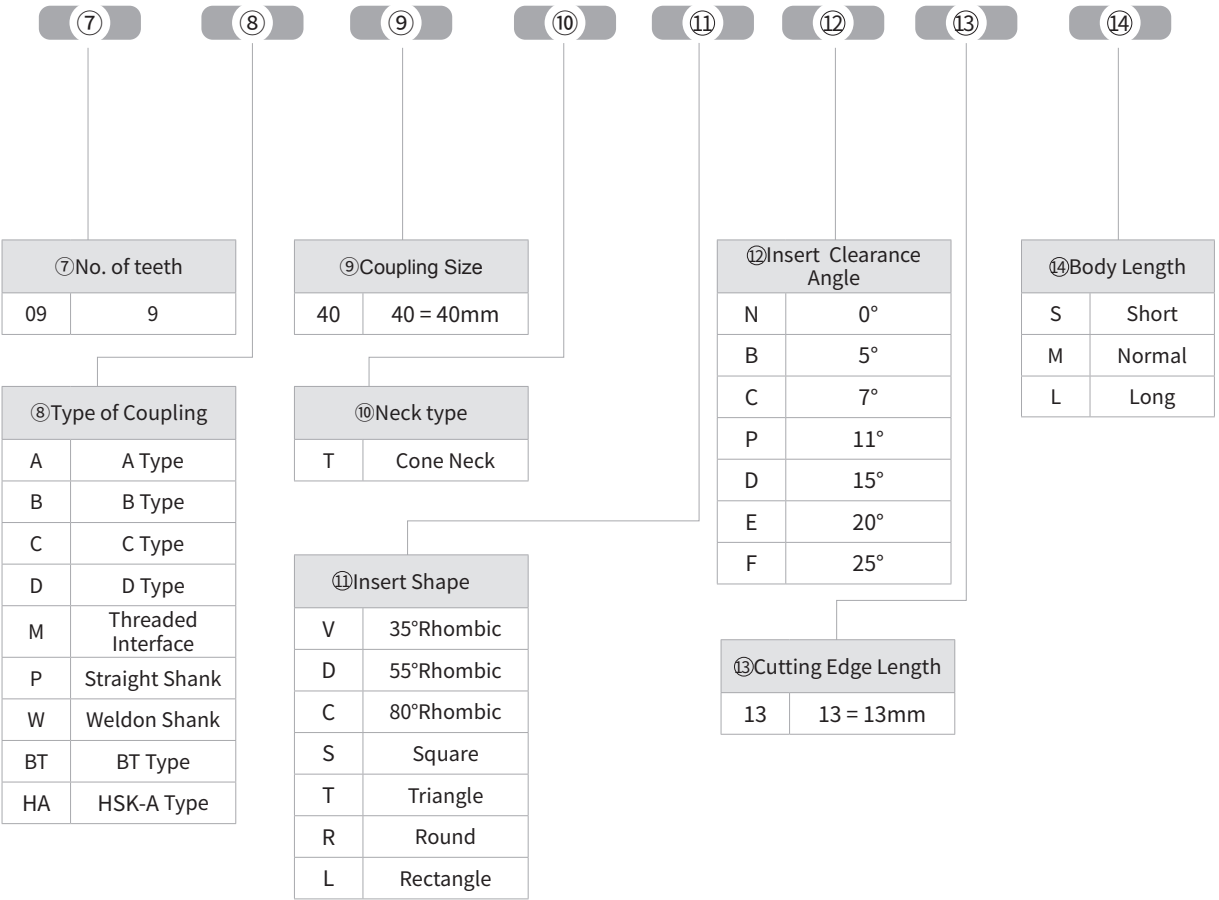

Series Introduction

Face Milling Series

ODK(M)T

Positive eight edges 43° face milling
ODK(M)T insert+MFA143 cutter holder

- Positive insert with eight edges, high economical efficiency
- The insert is with wiper design, suitable for finishing machining
- Suitable for finishing and semi-finishing machining of steel, cast iron and aluminum alloy



SEE(M)T

Positive four edges 45° face milling
SEE(M)T insert+MFA145 cutter holder

- Single-face positive insert with four edges various breaker designs
- The insert is with wiper design, suitable for finishing machining
- Suitable for finishing and semi-finishing machining of steel, cast iron and stainless steel



SNE(M)U

Negative eight edges 45°/75°/88° face milling
SNE(M)U insert+MFB145/245/275/288 cutter holder

- The insert is with thickening double face negative eight edges design, good strength, stable processing
- There are different cutting edge angles of 45°/75°/88°/ R radius
- There are sparse teeth, dense teeth and super dense teeth for choice. Suitable for different cutting conditions
- MFB145 series is with Shim to protect the cutter holder
- Suitable for the semi-finishing and roughing face milling of steel and cast iron

- NEW** • New cutter with an uneven pitch of teeth meets requirements in different applications



Series Introduction

Face Milling Series

HNE(M)X

Negative twelve edges 60° face milling
HNE(M)X insert + MFB160/MFB260 Cutter Holder

- Double-sided negative 12-edged insert design for cost effective and strength, for machining cast iron materials
- The MFB160 has an adjustable mechanism to ensure surface quality
- The MFB160 is available with a choice of sparse and dense teeth to cope with different cutting conditions
- Mainly used for roughing to finish machining of cast iron materials



HNGU NEW

Negative Twelve Edges 15°/45°/60° Face Milling
HNGU inserts + MFC115/ MFC145/ MFC160
/ Cutter Holders

- Double-side with 12 cutting edges achieving cost effective.
- The sectional cutting edge design for the inserts which make the insert is matched with 3 different entering angle holders.
- Have both Sparse pitch and dense pitch available, suitable for all kinds of machining requirement.
- Suitable for roughing and semi-finishing of steel, stainless steel and cast iron.



Series Introduction

Shoulder Milling Series

APM(G)T

Positive two edges shoulder milling
APM(G)T insert+MEA190 cutter holder

- There are many geometries available, suitable for different cutting condition
- There are geometries for aluminum alloy, suitable for machining of aluminum alloy
- Suitable for roughing machining of steel, stainless steel, cast iron and aluminum alloy



APK(E)T

Positive two edges shoulder milling
APK(E)T insert+MEB190/MHB190
cutter holder

- The edge is with curve type design to decrease the cutting resistance
- Match with corn milling cutter holder, with high milling efficiency
- There are geometries for aluminum alloy, suitable for machining of aluminum alloy
- Suitable for semi-finishing and roughing machining of steel, stainless steel, cast iron and aluminum alloy



ANKX

Negative four edges shoulder milling
ANKX insert+MEC190/MHC190 cutter holder

- Negative type thickening design, with high strength, suitable for heavy cutting
- The edge is grinding type and with curve design, suitable for vertical wall machining
- Match with corn milling cutter holder, suitable for high efficiency heavy cutting
- Suitable for semi-finishing and roughing machining of steel, cast iron



Series Introduction

Shoulder Milling Series

WNGU

Negative six edges shoulder milling WNGU insert+MEE190 cutter holder

- Negative six edges design, with high economical efficiency
- Negative double face and big rake angle design , improve strength and ensure sharpness
- The bottom edge is wipe edge, ensure the cutting surface with good quality
- Available for face milling, shoulder milling, grooving milling and so on
- Suitable for semi-finishing and roughing machining of steel and cast iron
- NEW** • New cutter with uneven pitch of teeth meeting different application requirement



SDKT

Positive four edges shoulder milling SDKT insert+MES190 cutter holder

- Curve edge design with small cutting resistance
- Multi-clearance angle design, ensure the inserts with higher strength and sharpness
- Available for face milling, shoulder milling, grooving milling and so on
- Suitable for semi-finishing and roughing machining of steel and cast iron



XDHT

Positive double edges shoulder milling for aluminum XDHT insert +MEH190 cutter holder

- Big rake angle design, ensures small cutting resistance
- Positive double clearance angle design, improve the strength of the edge
- Long cutting edge design, suitable for big cutting depth
- Curve edge design, ensure to achieve a 90° step in shoulder milling
- Suitable for semi-finishing and roughing of aluminum alloy



Series Introduction

Shoulder Milling Series

APEW **NEW**

Square-shoulder milling with positive two-edged finish grinding

APEW insert + MEJ190 tool body

- Spiral edge design for improved sidewall machining accuracy
- Special cutting edge design for reciprocating fine insert milling
- Finely ground surface for high precision machining

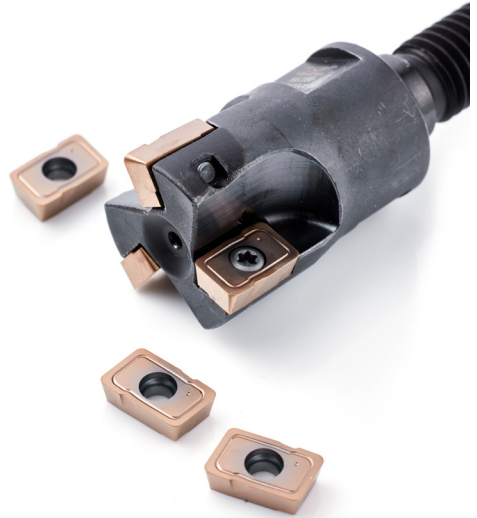

LNE(M)T

Vertically Eight Flutes Square Shoulder Milling

LNE(M)T insert + MVA190/MVA290 cutter body

- Unique stand-mounted structure design, high strength, suitable for heavy-duty milling and high machining efficiency
- Negative 8-edged design for left and right handed tool bodies
- Two types of teeth are available for different cutting conditions
- V-shaped positioning structure design, more stable clamping
- Mainly used for rough machining of steel and cast iron materials



Series Introduction

Profile Milling Series

RD/RP/RC

Positive profile milling

RD/RP/RC insert + MPA100/MPB100/MPC100 cutter holder

- With economical and high efficiency, suitable for the profile milling of mould industry
- With a full range of geometry, available from light cutting to heavy cutting
- RC+MPC100 is with anti-rotation design, ensure stable cutting
- Budget friendly inserts and high precision type inserts for choice, meeting the needs of different customers
- Suitable for semi-finish and roughing machining of steel



QTD

Finishing ballnose milling

QTD insert +MBA100 cutter holder

- Full R shape design, there are edges available even in the cutting for straight wall face
- Special edge design, ensure the edge with higher strength
- QTD-S-T is with curve edge design, ensuring small resistance
- Suitable for finishing machining of steel, cast iron and hardened steel



Series Introduction

High Feed Milling Series

UD/UP

Positive triple edges high feed milling
UD/UP insert +MKA110 cutter holder

- Multi segments line edge design, Improves cutting effect in different cutting depth
- With resistance-reduce groove design, ensure to reduce the cutting temperature
- There are 3 size inserts with different geometries, available for cutting in most of the Available for the majority of cutting conditions
- Suitable for roughing machining of steel, cast iron and stainless steel



SDMT

Positive four edges high feed milling
SDMT insert +MKB113 cutter holder
SDMT-SM insert +MKM113 cutter holder

- With A big arc curve edge design, improve the strength of The R angle
- With SM geometry which is with changing rake angle and changing edge width, suitable for the aerospace industry
- Suitable for roughing machining of steel, cast iron, stainless steel and difficult-to-cut material



Series Introduction

Slot Milling Series

SNEX

Narrow slot three face edges slot milling
SNEX insert + MSA104-108 cutter holder

- Sharp edge design, ensure reduce cutting resistance
- There are 5 different widths of slot available
- Suitable for semi-finishing and roughing machining of steel and cast iron



CNEU

Medium slot three face edges slot milling
CNEU insert + MSA110-113 cutter holder

- Positive cutting performance, the cutting is light and fast
- Grinding type changing rake angle design, Ensures reduced cutting resistance
- Suitable for semi-finishing and roughing machining of steel and cast iron



Series Introduction

Chamfer Milling Series

SPMT

Positive four edges chamfer milling
SPMT inserts +MCA130/145/160 cutter holder

- Four effective cutting edges, ensure both forward direction chamfer and opposite direction chamfer available
- The cutter holder is with multi cutting edge angle design, available for chamfer cutting of 30°/45°/60°
- Suitable for semi-finishing and roughing machining of steel and cast iron

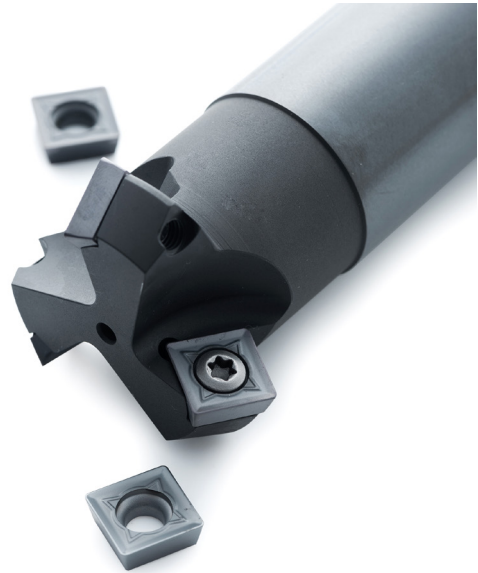

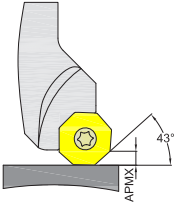
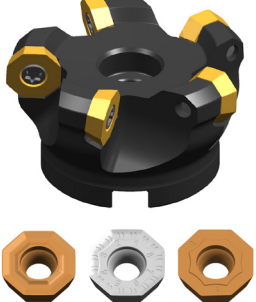
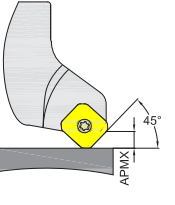
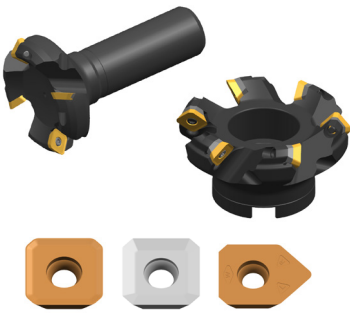
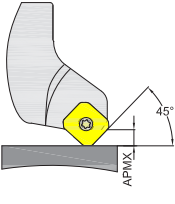
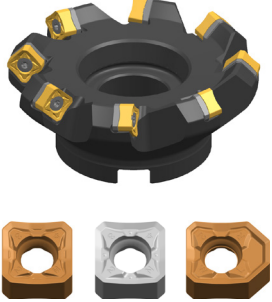
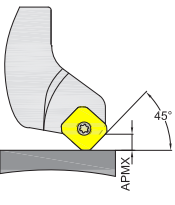
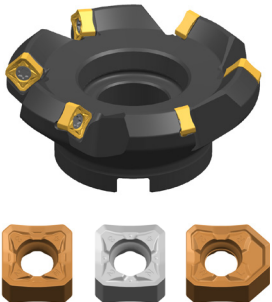

Product Application Chart

Type	Application	Inserts Series	Cutter Holder Series	Picture	Product Application
Face Milling	 <p>OD06: APMX =4.0mm</p>	ODK(M)T P035	MFA143 (Φ40-Φ200)		Face milling for steel, alloy steel, cast iron, aluminum alloy.
	 <p>SE13: APMX =6.0mm</p>	SEE(M)T P039	MFA145 (Φ50-Φ160)		Face milling for steel, alloy steel, cast iron, aluminum alloy.
	 <p>SN12: APMX =3.0mm</p>	SNE(M)U P044	MFB145 (Φ50-Φ315) Including holders with uneven teeth		High efficiency face milling for steel, cast iron.
	 <p>SN12: APMX =3.0mm</p>		MFB245 (Φ50-Φ315) Including holders with uneven teeth		

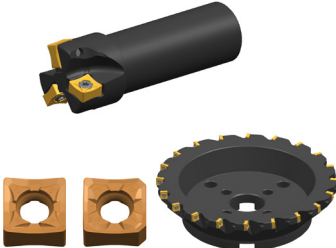

Product Application Chart

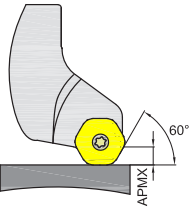
Type	Application	Inserts Series	Cutter Holder Series	Picture	Product Application
Face Milling	 <p>SN12: APMX = 5.0mm</p>	SNE(M)U	MFB275 (Φ50-Φ315)		High efficiency face milling for steel, cast iron.
	 <p>SN12: APMX = 7.0mm</p>		P044	MFB288 (Φ40-Φ315)	
	 <p>HN06: APMX = 1.6mm HN09: APMX = 2.2mm</p>	HNGU	MFC115 (Φ25-Φ160)		Face milling in steel, cast iron, stainless steel, etc.
	 <p>HN06: APMX = 3.2mm HN09: APMX = 4.5mm HN13: APMX = 8.0mm</p>		P057	MFC145 (Φ25-Φ315) Including holders with uneven teeth	

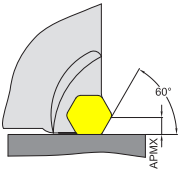
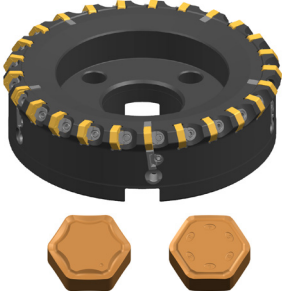
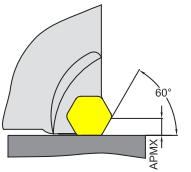
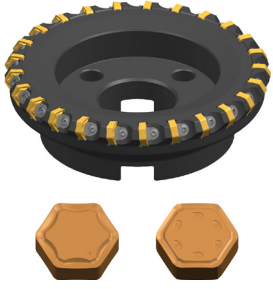
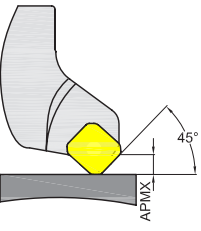
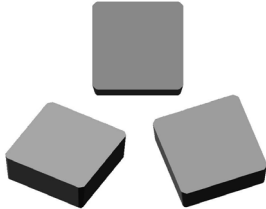



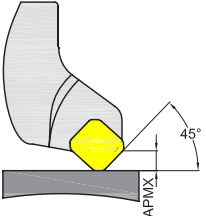
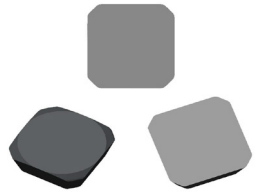
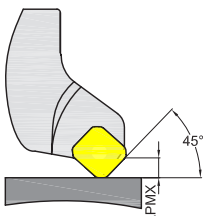

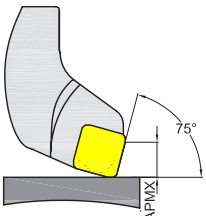
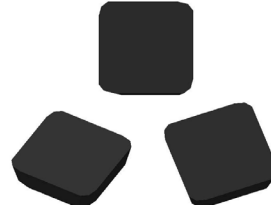
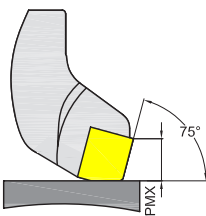
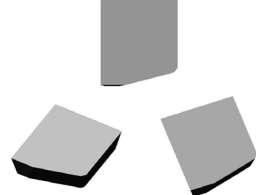
Product Application Chart

Type	Application	Inserts Series	Cutter Holder Series	Picture	Product Application
Face Milling	 <p>HN06: APMX =4.3mm HN09: APMX =7.4mm</p>	HNGU P057	MFC160 (Φ40-Φ250)		Face milling in steel, cast iron, stainless steel, etc.
	 <p>HN09: APMX =8.0mm</p>	HNE(M)X P068	MFB160 (Φ125-Φ315)		High performance, cost-effective, adjustable face milling machining for cast iron.
	 <p>HN09: APMX =8.0mm</p>		MFB260 (Φ63-Φ315)		High efficiency, cost-effective and dense teeth face milling machining for cast iron.
Face Milling	 <p>SB12: APMX =7.1mm</p>	SBEX P073	—		Face Milling for steel, alloy steel, cast iron

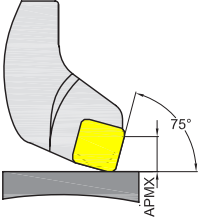

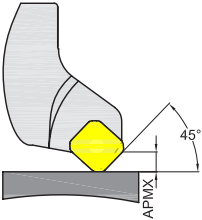

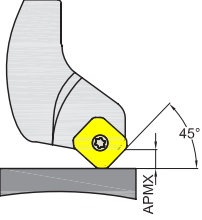

Product Application Chart

Type	Application	Inserts Series	Cutter Holder Series	Picture	Product Application
Face Milling	 <p>SE12: APMX =7.5mm SE15: APMX =9.1mm</p>	SEEN SEMN SEEX P073	—		Face Milling for steel, alloy steel, cast iron
	 <p>SP15: APMX =13.3mm SP19: APMX =16.3mm SP25: APMX =21.8mm</p>	SPEN P074	—		
	 <p>SP12: APMX =11.4mm SP15: APMX =13.2mm SP19: APMX =15.6mm</p>	SPK(M)N P075	—		
	 <p>SP15: APMX =14.0mm</p>	SPEN-W P076	—		

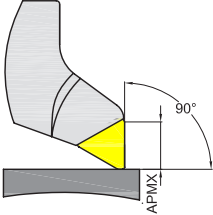

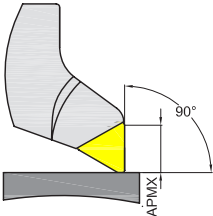
Product Application Chart

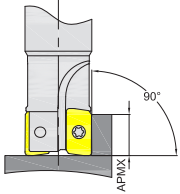
Type	Application	Inserts Series	Cutter Holder Series	Picture	Product Application
Face Milling	 <p>SP12: APMX = 10.7mm</p>	SPER P076	—		Face Milling for steel, alloy steel, cast iron
	 <p>SP15: APMX = 9.5mm</p>	SPNR P077	—		
	 <p>SP12: APMX = 7.5mm SP15: APMX = 9.5mm</p>	SPCW P077	—		

Product Application Chart

Type	Application	Inserts Series	Cutter Holder Series	Picture	Product Application
Face Milling	 <p>TP16: APMX =13.5mm TP22: APMX =15.1mm</p>	<p>TPER TPKR TPKN</p> <p>P078</p>	—		Face Milling for steel, alloy steel, cast iron
	 <p>TP22: APMX =15.1mm</p>	<p>TPNR</p> <p>P078</p>	—		
Shoulder Milling	 <p>AP11: APMX =9.0mm AP16: APMX =14.0mm</p>	<p>APM(G)T</p> <p>P079</p>	<p>MEA190 (Φ16-Φ250)</p>		Shoulder, face, slot and cavity milling for steel, cast iron, stainless steel and aluminum alloy.

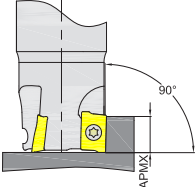
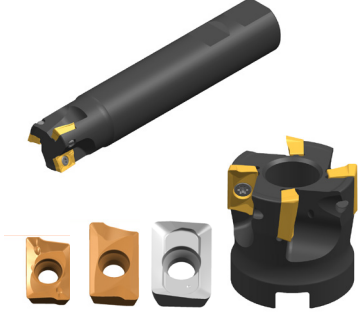
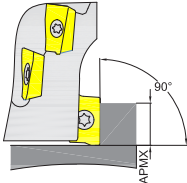
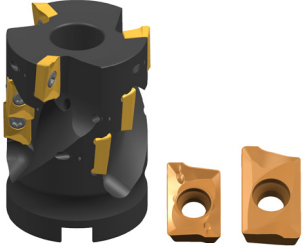
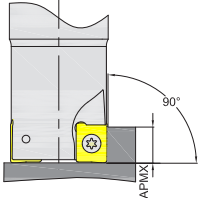

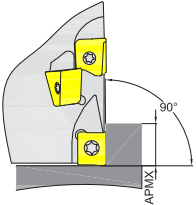
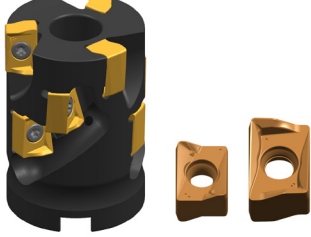



Product Application Chart

Type	Application	Inserts Series	Cutter Holder Series	Picture	Product Application
Shoulder Milling	 <p>AP11: APMX = 9.0mm AP16: APMX = 14.0mm</p>	APK(E)T P084	MEB190 ($\phi 16$ - $\phi 200$)		Shoulder, face, slot and cavity milling for steel, cast iron, stainless steel and aluminum alloy.
	 <p>AP11: APMX = 39.9mm AP16: APMX = 57.0mm</p>	APKT P084	MHB190 ($\phi 32$ - $\phi 80$)		Big cutting depth shoulder milling for steel and cast iron.
	 <p>AN12: APMX = 9.0mm AN16: APMX = 14.0mm</p>	ANKX	MEC190 ($\phi 32$ - $\phi 200$)		High efficiency and economical shoulder, slot milling for steel and cast iron.
	 <p>AN12: APMX = 43.0mm AN16: APMX = 57.0mm</p>		MHC190 ($\phi 40$ - $\phi 80$)		Deeper cutting depth shoulder milling for steel and cast iron.

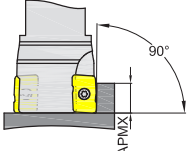

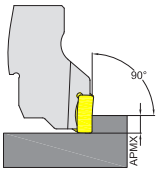

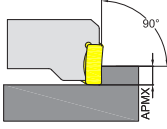
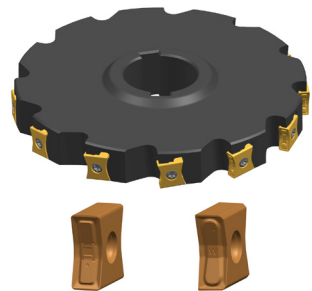
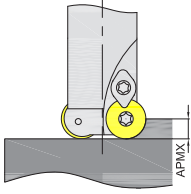

Product Application Chart

Type	Application	Inserts Series	Cutter Holder Series	Picture	Product Application
Shoulder Milling	 <p>WN04: APMX = 4.0mm WN08: APMX = 7.5mm</p>	WNGU P094	MEE190 ($\phi 20$ - $\phi 200$) Including holders with uneven teeth		High efficiency and economical shoulder, slot milling for steel and cast iron.
	 <p>SD14: APMX = 10.0mm</p>	SDKT P099	MES190 ($\phi 40$ - $\phi 315$)		High efficiency and economical shoulder, slot milling for steel and cast iron.
	 <p>XD19: APMX = 18.0mm</p>	XDHT P104	MEH190 ($\phi 25$ - $\phi 125$)		High efficiency shoulder milling for aluminum alloy.
	 <p>XP16: APMX = 14.0mm</p>	XPHT P108	—		Shoulder milling for steel and cast iron.

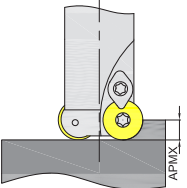

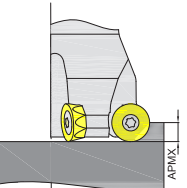

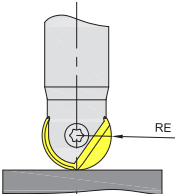
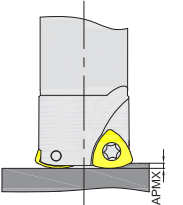
Product Application Chart

Type	Application	Inserts Series	Cutter Holder Series	Picture	Product Application
Shoulder Milling	 <p>AP10: APMX = 2.5mm</p>	APEW P109	MEJ190 ($\phi 17$ - $\phi 26$)		Pocket milling, shoulder milling, and slot milling semi-finishing to finishing for Hardened steel.
	 <p>LN11: APMX = 5.0mm LN15: APMX = 7.0mm</p>	LNE(M)T	MVA190 ($\phi 40$ - $\phi 315$)		Heavy duty shoulder milling and face milling for steel and cast iron.
	 <p>LN15: APMX = 7.0mm</p>		MVA290 ($\phi 80$ - $\phi 250$)		
Profile Milling	 <p>RD05: APMX = 2.5 mm RD07: APMX = 3.5 mm RD08: APMX = 4.0 mm RD10: APMX = 5.0 mm RD12: APMX = 6.0 mm RD16: APMX = 8.0 mm</p>	RD P119	MPA100 ($\phi 10$ - $\phi 125$)		Profile, face, slot and pocket milling of steel and cast iron.



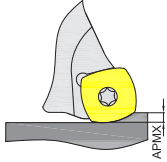

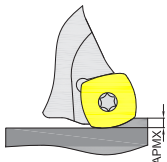
Product Application Chart

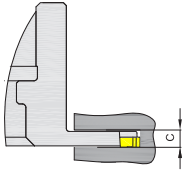
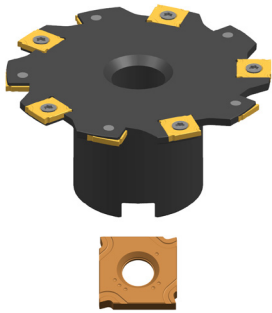
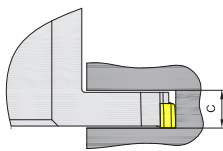
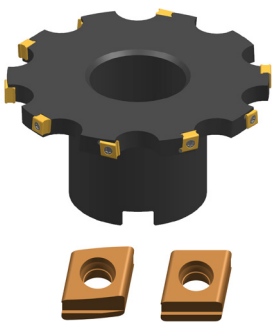
Type	Application	Inserts Series	Cutter Holder Series	Picture	Product Application
Profile Milling	 <p>RP08: APMX = 4.0mm RP10: APMX = 5.0 mm RP12: APMX = 6.0 mm RP16: APMX = 8.0 mm</p>	RP P123	MPB100 (Φ16-Φ125)		Profile, face, slot milling and pocket milling of steel and alloy steel.
	 <p>RC10: APMX = 5.0 mm RC12: APMX = 6.0 mm RC16: APMX = 8.0 mm RC20: APMX = 10.0 mm</p>	RC P127	MPC100 (Φ20-Φ160)		Profile, face, slot milling and pocket milling of steel and alloy steel.
		QTD P135	MBA100 (Φ12-Φ32)		High precision profile milling for steel, cast iron and hardened steel.
High Feed Milling	 <p>UD08: APMX = 1.0mm UD12: APMX = 1.5mm UP17: APMX = 2.0mm</p>	UD/UP P140	MKA110 (Φ20-Φ100)		High efficiency face, slot and cavity milling for steel, cast iron and stainless steel.

Product Application Chart

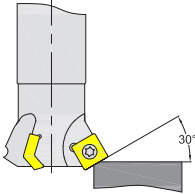
Type	Application	Inserts Series	Cutter Holder Series	Picture	Product Application
High Feed Milling	 <p>SD12: APMX =2.0mm SD15: APMX =3.0mm</p>	SDMT	MKB113 (Φ32-Φ160)		Face, slot milling and pocket milling of steel and alloy steel with high efficiency.
	 <p>SD09: APMX =1.0mm SD12: APMX =2.0mm</p>		P145	Special for aviation MKM113 (Φ25-Φ125)	
Slot Milling	 <p>C MIN =4.0mm C MAX =8.0 mm</p>	SNEX	MSA(104~108) (Φ100)		Slot milling for steel and cast iron.
	 <p>C MIN=10.0mm C MAX=13.0mm</p>		P156	CNEU MSA(110~113) (Φ80-Φ160)	

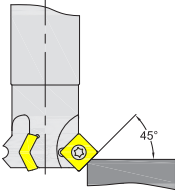
Product Application Chart

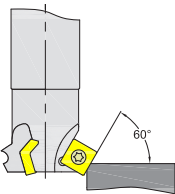
Type	Application	Inserts Series	Cutter Holder Series	Picture	Product Application
Chamfer Milling	 <p>SP09: APMX = 3.0mm SP12: APMX = 4.5mm</p>	SPMT	MCA130 ($\Phi 25-\Phi 32$)		Chamfer milling for steel and cast iron.
	 <p>SP09: APMX = 5.0mm SP12: APMX = 7.0mm</p>		MCA145 ($\Phi 25-\Phi 32$)		
	 <p>SP09: APMX = 6.0mm SP12: APMX = 8.0mm</p>		P160	MCA160 ($\Phi 25-\Phi 36$)	

Milling Inserts Grade

Grade for P

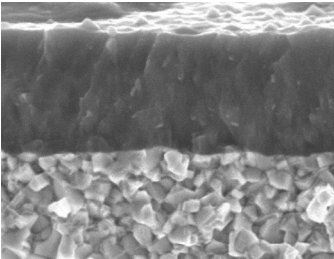
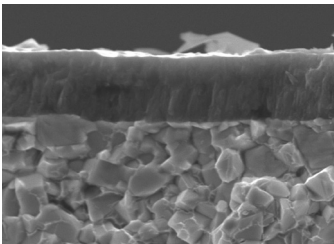
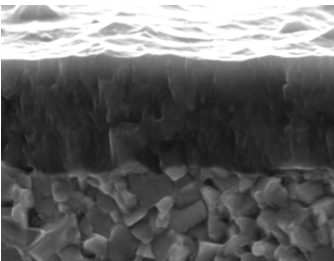
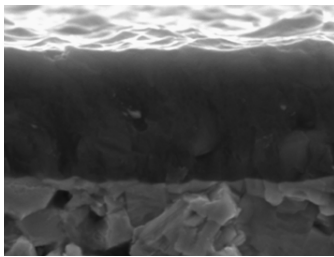
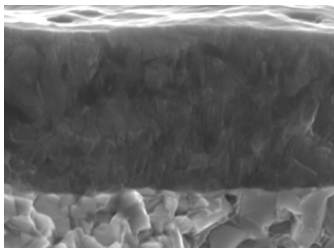
Workpiece	Grade	Color	Coating Type	Coating Structure	Features
P	GPM7120 NEW	Golden	PVD		<ul style="list-style-type: none"> • The newly upgraded TiAlN coating is matched with fine-grained wear-resistant cemented carbide substrate, which improves the wear resistance of milling processing and increase the cutting stability. • Suitable for medium to high hardness steel, both dry and wet cutting are available in medium to high-speed milling.
	GA4325	Golden	PVD		<ul style="list-style-type: none"> • Specially designed wear-resistant cemented carbide substrate, with newly upgraded AlCrN coating, has excellent wear resistance and oxidation resistance. • Suitable for medium-load processing of general steel, soft steel processing is the first choice.
	GA4225	Slate Grey	PVD		<ul style="list-style-type: none"> • Combination of PVD AlCrN coating and fine-grained cemented carbide Substrate. • Suitable for general processing of steel, cast iron and general materials under medium to low speed conditions.
	GA4230	Fuchsia	PVD		<ul style="list-style-type: none"> • The PVD TiAlN coating and cemented carbide substrate with high damage resistance have high bonding strength, which can realize stable processing under different working conditions. • Suitable for general processing of steel, cast iron and general material, with a wide range of applications.
	GP4225	Golden	PVD		<ul style="list-style-type: none"> • The newly upgraded nano-structured AlCrN coating is combined with the fine-grained cemented carbide matrix, which has excellent wear resistance. • Suitable for semi-finish to slight rough machining of steel.

Milling Inserts Grade

Grade for P

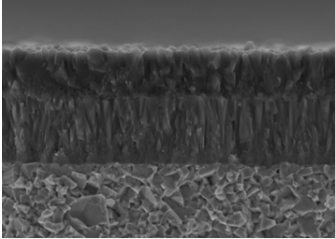
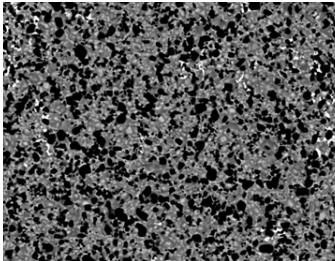
Workpiece	Grade	Color	Coating Type	Coating Structure	Features
P	GP2115	Black	CVD		<ul style="list-style-type: none"> • The ultra-fine MT-TiCN and Al₂O₃ coating are combined with high cobalt cemented carbide substrate, which can ensure the wear resistance, strength and toughness, and realize the stability and high efficiency of insert machining. • Suitable for fine to semi-finish milling of steel under medium to high speed conditions.
	GP01TM	—	Uncoating		<ul style="list-style-type: none"> • After excellent processing, Uncoated cermet milling grade has high toughness, high wear resistance and excellent edge collapse resistance. • Suitable for milling processing of various materials, mainly steel processing.

Grade for M

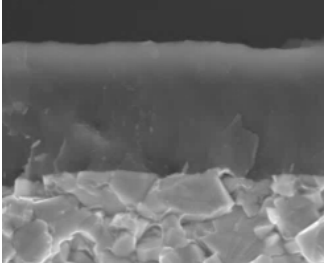
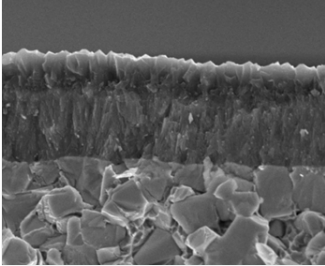
Workpiece	Grade	Color	Coating Type	Coating Structure	Features
M	GM4135	Dark Yellow	PVD		<ul style="list-style-type: none"> • The latest TiAlSiN multilayer coating, with high-strength fine-grained cemented carbide substrate, has good wear resistance, toughness and thermal stability. • It is suitable for rough machining and unstable working conditions of difficult-to-machine materials such as stainless steel and titanium alloy.
	GM2140	Black	CVD		<ul style="list-style-type: none"> • The upgraded MT-TiCN+ Al₂O₃ coating is matched with a fine-grained cemented carbide substrate, which has wear resistance, toughness and thermal stability. • Suitable for semi-finish to rough machining of stainless steel and titanium alloys.

Milling Inserts Grade

Grade for K

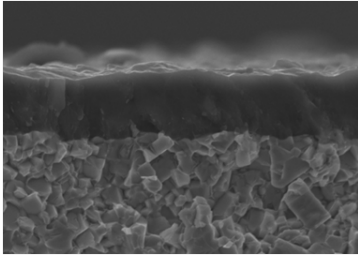
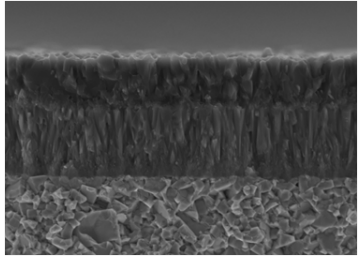
Workpiece	Grade	Color	Coating Type	Coating Structure	Features
K	GK4125	Grey Purple	PVD		<ul style="list-style-type: none"> • Nano-TiAlN coating is matched with fine-grained cemented carbide substrate, which has excellent wear resistance and anti-edge collapse. • It is suitable for semi-finishing to rough finishing, with low speed to medium speed, wet and dry milling of various cast irons.
	GK2115	Black	CVD		<ul style="list-style-type: none"> • The brand-new medium-thick MT-TiCN+Al₂O₃ coating with special fine-grained cemented carbide substrate, which has strength, toughness and wear resistance, ensuring the stability and efficiency of machining cast iron. • Suitable for precision to semi-finish milling of cast iron under medium to high speed conditions

Grade for N

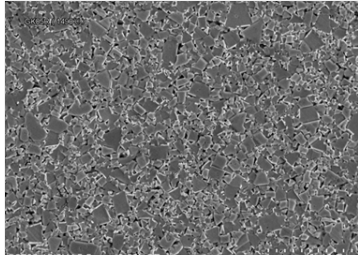
Workpiece	Grade	Color	Coating Type	Coating Structure	Features
N	GN9125	—	Uncoatig		<ul style="list-style-type: none"> • Uncoated fine-grained cemented carbide Grade, with good wear resistance and toughness. • Suitable on semi-finishing to roughing processing of copper and aluminum.

Milling Inserts Grade

Grade for S

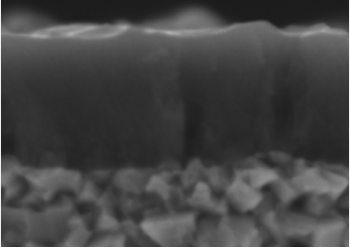
Workpiece	Grade	Color	Coating Type	Coating Structure	Features
	GS4130	Grey Purple	PVD		<ul style="list-style-type: none"> • The latest nano TiAlN coating is matched with a high-toughness fine-grained cemented carbide substrate, which has good wear resistance and toughness. • Suitable on semi finishing to roughing processing of titanium and high temperature alloy.

Grade for H

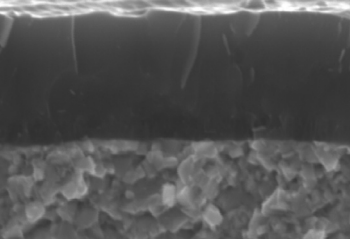
Workpiece	Grade	Color	Coating Type	Coating Structure	Features
	GH4115	Bronze	PVD		<ul style="list-style-type: none"> • The latest TiAlCrSiN coating is combined with ultra-fine grained cemented carbide substrate, which has both high oxidation resistance and red hardness. • Suitable for precision to semi-finish milling of high-hardness steel above 55HRC.



Application of Milling Grade

Workpiece Material	ISO	Coated		Uncoated	Cermet
		CVD	PVD		
P Steel	01				GP01TM
	10	GP2115	GA4325		
	20		GPM7120		
	30		GA4225		
	40		GA4225 <small>NEW</small>	GA4230	
M Stainless Steel	01				
	10				
	20				
	30	GM2140	GM4135		
	40		GS4130		
K Cast Iron	01				
	10	GK2115			
	20		GK4125		
	30				
	40				
N Nonferrous Metal	01				
	10				
	20			GN9125	
	30				
S HRSA	01				
	10		GS4130		
	20				
	30	GM2140	GM4135		
H Hardened Material	01				
	10		GH4115		
	20				
	30				

Application of Milling Cutter with Different Pitch

Choosing the proper number of cutting tool teeth is extremely important for balancing efficiency and precision in milling applications. Under the same cutting speed V_c and feed per tooth f_z , increasing the number of cutting edges can effectively increase production efficiency, even though it also increases the cutting force at the same time. Machine power is an influential factor for choosing the number of cutting tool teeth. GEASC provides three types of pitch for different applications.

MFB145-080



Shape			
	Sparse Pitch	Dense Pitch	Extra Dense Pitch
NO. of Teeth	Z=5	Z=7	Z=8
Application	<ul style="list-style-type: none"> ● Superior rigidity, suitable for unstable working conditions ● Mainly used in high-feed and large-cutting-depth (ap.) machining, producing big chips ● First choice for carbon steel, alloy steel and stainless steel machining 	<ul style="list-style-type: none"> ● The best balance of rigidity and efficiency, first choice for general purpose machining ● Mainly used in medium feed and medium cutting depth(ap.) machining, medium size chip ● Also suitable for hardened steel and heat-resistance alloy machining 	<ul style="list-style-type: none"> ● With high efficiency, most suitable for stable working condition ● Mainly used in low feed and small cutting depth(ap.), small size chip ● First choice for cast iron and easy chip breaker workpieces machining

Face Milling

ODK(M)T

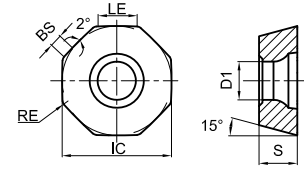

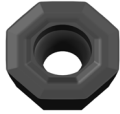
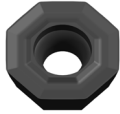
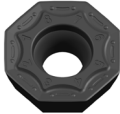
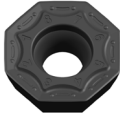

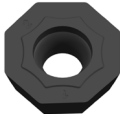



Positive with Eight Edges

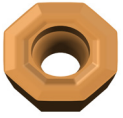

Ordering Code	Dimension(mm)						Coating Grade										Uncoated	Cermet				
	LE	IC	S	D1	RE	BS	GA4225	GA4230	GA4325	GPM7120	GP4225	GP2115	GM4135	GM2140	GK4125	GK2115			GS4130	GH4115	GN9125	GP01TM
 ODKT060508-GL	5	15.875	5.56	5.56	0.8	1.8	●															
 ODKT060508-GM	5	15.875	5.56	5.56	0.8	1.5	●		●	●			○	●	●							
 ODMT060508-GM	5	15.875	5.56	5.56	0.8	1.5	●	●		○			●	○	●		○					
 ODKT060508-GH	5	15.875	5.56	5.56	0.8	1.8	●			●					●							
 ODMT060508-GH	5	15.875	5.56	5.56	0.8	1.8	●			○												
 ODKT060508-AL	5	15.875	5.56	5.56	0.8	1.8																●
 ODKW060508-WB	5	15.875	5.56	5.56	0.8	5.7	●															

● Stock ○ Available Upon Order

ODK(M)T Series Geometry

Light Cutting for General Material	Medium Cutting for General Material	Heavy Cutting for General Material	General Cutting for Aluminum Alloys	Wiper
				
GL	GM	GH	AL	WB
				
Large rake angle with narrow edge width. Suitable for light milling with low cutting speed and low feed.	Large rake angle smoothly cutting. High stability milling can be achieved under general cutting conditions.	Wide chip pocket with strong cutting edge for Rough cutting.	Large rake angle, sharp cutting edge, good polishment and good chip control.	Wiper design to improve the surface quality.

Face Milling

MFA143

Arbor

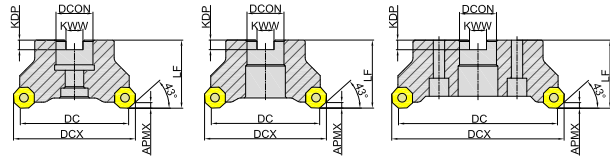
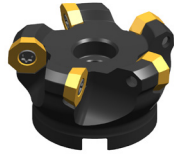

Fig1

Fig2

Fig3

Ordering Code	Dia-meter	Teeth	Dimension(mm)						APMX	Suitable for	Coolant	Shape	Weight (KG)	Stock
			DC	DCX	DCON	LF	KWW	KDP						
MFA143040R03A16OD06	40	3	40	50	16	40	8.4	5.6	4	ODK(M)T0605	×	Fig1	0.20	●
MFA143050R04A22OD06	50	4	50	60	22	40	10.4	6.3	4	ODK(M)T0605	×	Fig1	0.31	●
MFA143063R05A22OD06	63	5	63	72	22	40	10.4	6.3	4	ODK(M)T0605	×	Fig1	0.50	●
MFA143080R06B27OD06	80	6	80	90	27	50	12.4	7	4	ODK(M)T0605	×	Fig2	0.88	●
MFA143100R07B32OD06	100	7	100	110	32	50	14.4	8	4	ODK(M)T0605	×	Fig2	1.43	●
MFA143125R08B40OD06	125	8	125	135	40	63	16.4	9	4	ODK(M)T0605	×	Fig2	3.02	●
MFA143160R10C40OD06	160	10	160	170	40	63	16.4	9	4	ODK(M)T0605	×	Fig3	4.12	●
MFA143200R12C60OD06	200	12	200	210	60	63	25.7	14	4	ODK(M)T0605	×	Fig3	6.42	●

● Stock ○ Available Upon Order

Spare Parts

Part Name		Inserts Screw	Recommended Torque	Insert Screw Wrench
Inserts	Shape			
	Ordering Code	SI60M050108-07209S	5.0N·m	TT20TQ

Recommended Cutting Data









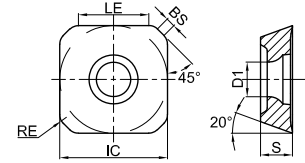

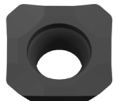
Workpiece	Hardness	Grade	Specification	Ap (mm)	Cutting Speed Vc(m/min)	Feed Rate/Edges fz(mm)			
						Light Cutting(L)	Medium Cutting(M)	Heavy Cutting(H)	
P	Soft Steel	≤ HB180	GPM7120 GA4225 GA4230	ODK(M)T0605	2	220 (180-260)	0.2 (0.1-0.3)	0.25 (0.15-0.35)	0.3 (0.2-0.4)
	Carbon Steel, Alloy Steel	HB180-350	GPM7120 GA4225 GA4230 GP2115	ODK(M)T0605	2	220 (180-260)	0.15 (0.1-0.2)	0.25 (0.15-0.35)	0.3 (0.2-0.4)
	Pre-hardened Steel	HRC35-45	GPM7120 GA4230 GA4225 GP2115	ODK(M)T0605	2	150 (110-190)	0.1 (0.05-0.15)	0.15 (0.1-0.2)	0.2 (0.1-0.3)
M	Stainless (Ferrite, Martensite)	≤ HB270	GM2140 GA4230	ODK(M)T0605	2	160 (120-200)	0.15 (0.1-0.2)	0.25 (0.15-0.35)	0.3 (0.2-0.4)
	Stainless (Austenite, Duplex)	≤ HB270	GM2140	ODK(M)T0605	2	140 (100-180)	0.1 (0.05-0.15)	0.15 (0.1-0.2)	0.2 (0.1-0.3)
K	Grey Cast Iron	≤ HB280	GK2115 GK4125	ODK(M)T0605	2	180 (140-220)	0.2 (0.1-0.3)	0.25 (0.15-0.35)	0.3 (0.2-0.4)
	Nodular Cast Iron, Vermicular Graphite Cast Iron	≤ HB350	GK4125 GK2115	ODK(M)T0605	2	160 (120-200)	0.15 (0.1-0.2)	0.25 (0.15-0.35)	0.3 (0.2-0.4)
N	Nonferrous Metal	HB60-210	GN9125	ODKT0605	2	≥ 300	0.15 (0.1-0.2)	0.2 (0.1-0.3)	0.25 (0.2-0.4)
S	Heat-resistant Alloy and Titanium Alloy	HRC30-45	GS4130	ODK(M)T0605	2	40 (30-60)	0.15 (0.1-0.2)	0.2 (0.1-0.3)	—

Face Milling

SEE(M)T





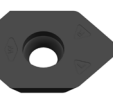





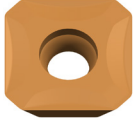

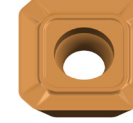
General Face Milling

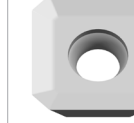
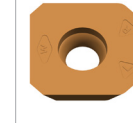

Ordering Code	Dimension(mm)						Coating Grade										Uncoated	Cermat			
	LE	IC	S	D1	RE	BS	GA4225	GA4230	GA4325	GPM7120	GP4225	GP2115	GM4135	GM2140	GK4125	GK2115			GS4130	GH4115	GN6125
 SEET1204AFEN-PL	8.2	12.7	4.76	5.5	1.2	1.6	●	●	●	●	●			●	●		●				
 SEET13T3AGEN-PL	8.8	13.4	3.97	4.4	1	1.7	●	●	●	●	○			●			●				
 SEET13T3AGEN-PM	8.8	13.4	3.97	4.4	1.5	1.2	●	●	●	●				●	●		●				
 SEMT13T3AGEN-PM	8.8	13.4	3.97	4.4	1.5	1.2	●	●	●		●			●	●		●				
 SEET13T3AGSN-PH	8.8	13.4	3.97	4.4	1.66	1.2	○	●	○		○			○	●						
 SEMT13T3AGSN-PH	8.8	13.4	3.97	4.4	1.66	1.2	○	●	○		●			○	○						
 SEET13T3AGSN-KM	8.8	13.4	3.97	4.4	1.44	1.3	○		●						●		○				
 SEET13T3AGSN-KH	8.8	13.4	3.97	4.4	1.6	1.3	○		○		○				●						
 SEMT13T3AGSN-KH	8.8	13.4	3.97	4.4	1.6	1.3			○						○	○					
 SEET13T3AGFN-AL	9.6	13.4	3.97	4.4	0.4	2.2															●
 SEET13T3AGEN-WB	9.5	13.4	3.97	4.3	1.2	7.5		●								○					

● Stock ○ Available Upon Order

SEE(M)T Series Geometry

Light Cutting for General Material	Medium Cutting for General Material	Heavy Cutting for General Material	Medium Cutting for Cast Iron	Rough Cutting for Cast Iron	General Cutting for Aluminum Alloys	Wiper
						
PL	PM	PH	KM	KH	AL	WB
						
Large rake angle with narrow edge width. Suit for light milling with low cutting speed and low feed.	Large rake angle design, easy cutting. High stability milling can be achieved under general cutting conditions.	Strong cutting edge for interrupted cutting condition. Excellent performance when removing black skin.	The chipbreaker specially for cast iron. Suitable for medium cutting.	Special chipbreaker for cast iron. Suitable for interrupted cutting condition and excellent performance when removing black skin under rough machining.	Large rake angle, sharp cutting edge, mirror polished, smoothly chip removal.	With big circle wiper edge, improve the surface quality.

Face Milling

MFA145

Arbor

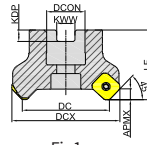
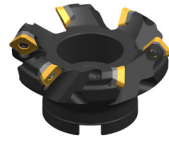

Fig1

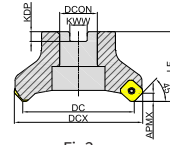

Fig2

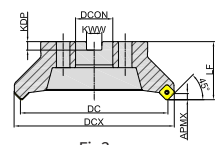

Fig3

Sparse Pitch

Ordering Code	Dia- meter	Teeth	Dimension(mm)							APMX	Suitable for	Shim	Coolant	Shape	Weight (KG)	Stock
			DC	DCX	DCON	LF	KWW	KDP								
MFA145050R03A22SE13	50	3	50	63	22	40	10.4	6.3	6	SEE(M)T13T3	×	×	Fig1	0.41	●	
MFA145063R04A22SE13	63	4	63	76	22	40	10.4	6.3	6	SEE(M)T13T3	×	×	Fig1	0.62	●	

● Stock ○ Available Upon Order

Dense Pitch

Ordering Code	Dia- meter	Teeth	Dimension(mm)							APMX	Suitable for	Shim	Coolant	Shape	Weight (KG)	Stock
			DC	DCX	DCON	LF	KWW	KDP								
MFA145050R04A22SE13	50	4	50	63	22	40	10.4	6.3	6	SEE(M)T13T3	×	×	Fig1	0.37	●	
MFA145063R05A22SE13	63	5	63	76	22	40	10.4	6.3	6	SEE(M)T13T3	×	×	Fig1	0.58	●	
MFA145080R06B27SE13	80	6	80	93	27	50	12.4	7	6	SEE(M)T13T3	✓	×	Fig2	0.99	●	
MFA145100R07B32SE13	100	7	100	113	32	50	14.4	8	6	SEE(M)T13T3	✓	×	Fig2	1.71	●	
MFA145125R08B40SE13	125	8	125	138	40	50	16.4	9	6	SEE(M)T13T3	✓	×	Fig2	3.09	●	
MFA145160R10C40SE13	160	10	160	173	40	63	16.4	9	6	SEE(M)T13T3	✓	×	Fig3	4.35	●	
MFA145200R12C60SE13	200	12	200	213	60	63	25.7	14	6	SEE(M)T13T3	✓	×	Fig3	5.95	○	

● Stock ○ Available Upon Order

Face Milling

MFA145

Cylindrical Straight Type

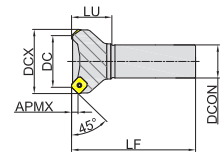

Fig4

Sparse Pitch

Ordering Code	Dia-meter	Teeth	Dimension(mm)					APMX	Suitable for	Shim	Coolant	Shape	Weight (KG)	Stock
			DC	DCX	DCON	LF	LU							
MFA145050R03P32SE13	50	3	50	63	32	120	39	6	SEE(M)T13T3	×	×	Fig4	0.94	●
MFA145063R04P32SE13	63	4	63	76	32	120	39	6	SEE(M)T13T3	×	×	Fig4	1.09	●

● Stock ○ Available Upon Order

Dense Pitch

Ordering Code	Dia-meter	Teeth	Dimension(mm)					APMX	Suitable for	Shim	Coolant	Shape	Weight (KG)	Stock
			DC	DCX	DCON	LF	LU							
MFA145050R04P32SE13	50	4	50	63	32	120	39	6	SEE(M)T13T3	×	×	Fig4	0.90	●
MFA145063R05P32SE13	63	5	63	76	32	120	39	6	SEE(M)T13T3	×	×	Fig4	1.05	●

● Stock ○ Available Upon Order

Spare Parts

Part Name		Shim	Shim Screw	Wrench	Inserts Screw	Recommended Torque	Insert Screw Wrench	
Inserts	Shape							
	Ordering Code	—	—	—	SI60M035080-05410B	3.0N·m	TT15PB	—
Ordering Code	H0K30DSE1300S	SSAM050070B	TH35LB	SI60M035116-05410IB	3.0N·m	TI15PB	TI15TB	

Note:

- ★ 1、 Without Shim cutter bodies MFA145, choose without Shim Spare Parts specification
- ★ 2、 With Shim cutter bodies MFA145, choose with Shim Spare Parts specification

Recommended Cutting Data









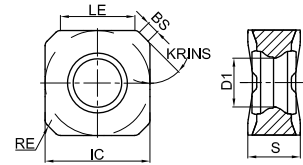

	Workpiece	Hardness	Grade	Specification	Ap (mm)	Cutting Speed Vc(m/min)	Feed Rate/Edges fz(mm)		
							Light Cutting(L)	Medium Cutting(M)	Heavy Cutting(H)
P	Soft Steel	≤ HB180	GA4325 GPM7120	SEE(M)T13T3	2	250 (210-290)	0.2 (0.1-0.3)	0.25 (0.15-0.35)	0.3 (0.2-0.4)
	Carbon Steel, Alloy Steel	HB180-350	GA4325 GPM7120 GP2115	SEE(M)T13T3	2	220 (180-260)	0.15 (0.1-0.2)	0.25 (0.15-0.35)	0.3 (0.2-0.4)
	Pre-harden Steel	HRC35-45	GPM7120 GA4325 GP2115	SEE(M)T13T3	2	140 (100-180)	0.1 (0.05-0.15)	0.15 (0.1-0.2)	0.2 (0.1-0.3)
M	Stainless (Ferrite, Martensite)	≤ HB270	GM2140	SEE(M)T13T3	2	180 (140-220)	0.15 (0.1-0.2)	0.25 (0.15-0.35)	0.3 (0.2-0.4)
	Stainless (Austenite, Diphasic)	≤ HB270	GM2140	SEE(M)T13T3	2	140 (100-180)	0.1 (0.05-0.15)	0.15 (0.1-0.2)	0.2 (0.1-0.3)
K	Grey Cast Iron	≤ HB280	GK2115 GK4125	SEE(M)T13T3	2	180 (140-220)	0.15 (0.1-0.2)	0.2 (0.1-0.3)	0.3 (0.2-0.4)
	Nodular Cast Iron, Vermicular Graphite Cast Iron	≤ HB350	GK4125 GK2115	SEE(M)T13T3	2	160 (120-200)	0.1 (0.05-0.2)	0.15 (0.1-0.2)	0.3 (0.2-0.4)
N	Nonferrous Metal	HB60-210	GN9125	SEET13T3	2	≥ 300	0.15 (0.1-0.2)	0.2 (0.1-0.3)	0.3 (0.2-0.4)
S	Heat- resistant Alloy and Titanium Alloy	HRC30-45	GS4130	SEE(M)T13T3	2	40 (30-60)	0.15 (0.1-0.2)	0.2 (0.1-0.3)	—

Face Milling

SNE(M)U

Negative with Eight Edge Face



Ordering Code	Dimension(mm)							Coating Grade										Uncoated	Cermat			
	LE	IC	S	BS	D1	KRINS	RE	GA4225	GA4230	GA4325	GPM7120	GP4225	GP2115	GM4135	GM2140	GK4125	GK2115			GS4130	GH4115	GN6125
SNEU1206ANEN-GL	9.1	12.7	6.35	1.6	5.9	45°	0.8	●			●	●	●		●	●	●	●				
																						
SNEU1206ANEN-GM	9.1	12.7	6.35	1.6	5.9	45°	0.8	●	●		●		●		●	●	●	●				
																						
SNMU1206ANEN-GM	9.1	12.7	6.35	1.6	5.9	45°	0.8	●	●	●	●	●		●	●	●	●					
																						
SNEU1206ANSN-GH	9.1	12.7	6.35	1.6	5.9	45°	0.8				●			●	●	●						
																						
SNMU1206ANSN-GH	9.1	12.7	6.35	1.6	5.9	45°	0.8	○	●		●				●	●						
																						
SNEU1206ANFN-NL	9.1	12.7	6.35	1.6	5.9	45°	0.8															●
																						
SNEU1206ANEN-GW	9	12.7	6.35	5.1	5.9	45°	0.8		●						●							
																						
SNEU1206ENEN-GM	9.9	12.7	6.35	1.2	5.9	75°	0.8		●			●	●		●	●	●	●				
																						
SNMU1206ENEN-GM	9.9	12.7	6.35	1.2	5.9	75°	0.8		●			●	●	○	●	●	○					
																						
SNMU1206ZNEN-GL	10.7	12.7	6.35	1.1	5.9	88°	0.8			○			●	●	●	●	○					
																						







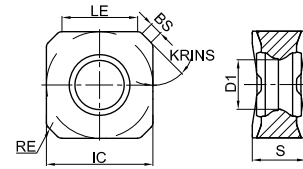

● Stock ○ Available Upon Order

Face Milling

SNE(M)U

Negative with Eight Edge Face











Ordering Code	Dimension(mm)							Coating Grade										Uncolored	Cermat					
	LE	IC	S	BS	D1	KRINS	RE	GA4225	GA4230	GA4325	GPM7120	GP4225	GP2115	GM4135	GM2140	GK4125	GK2115			GS4130	GH4115	GN9125	GP01TM	
 SNEU1206ZHEN-GM	10.7	12.7	6.35	1.1	5.9	88°	0.8	●	●	●	●	●	●	●	●	●	●	●	●	●	●	●	●	
 SNMU1206ZHEN-GM	10.7	12.7	6.35	1.1	5.9	88°	0.8	●	●	●	●	●	●	●	●	●	●	○						
 SNMU1206ZHEN-GH	10.7	12.7	6.35	1.1	5.9	88°	0.8		○							●	●							
 SNEU1206ZHEN-GW	10.1	12.7	6.35	4	5.9	88°	0.6									●								
 SNEU120612-GM	10.3	12.7	6.35	—	5.9	—	1.2	●	●			●		●	●	●	●	●						
 SNMU120612-GM	10.3	12.7	6.35	—	5.9	—	1.2	●			●	●		●	●	●	○							
 SNMU120616-GM	9.5	12.7	6.35	—	5.9	—	1.6									●	●							
 SNMU120620-GM	8.7	12.7	6.35	—	5.9	—	2.0									●	●	○						

Note:

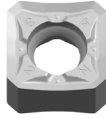
- ★ 1、SNE(M)U1206AN*N insert with MFB145/245 cutter holder;
- ★ 2、SNE(M)U1206ENEN insert with MFB275 cutter holder;
- ★ 3、SNE(M)U1206ZHEN insert with MFB288 ;
- ★ 4、SNEU120612-GM、SNMU120612/16/20-GM insert with MFB145/245/275/288 cutter holder.

● Stock ○ Available Upon Order

SNE(M)U Series Geometry

Light Cutting for General Material	Medium Cutting for General Material	Heavy Cutting for General Material	Aluminium Cutting	Wiper
				
GL	GM	GH	NL	GW
				
Large rake angle with narrow edge width. Suitable for light cutting of low cutting speed and low feed.	Large rake angle. High stability milling can be achieved under general cutting conditions.	High strength edge, interrupted cutting, excellent performance when removing black skin.	Large rake angle, sharp cutting edge, mirror polished, smoothly chip removal.	With big circle wiper edge, improve the surface quality.

Face Milling

MFB145

Arbor(with Shim)

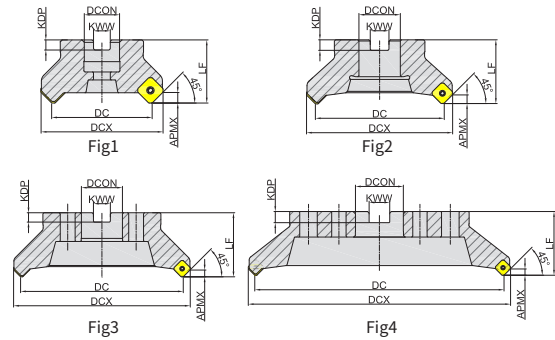
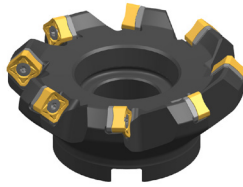

Sparse Pitch

Ordering Code	Dia-meter	Teeth	Dimension(mm)							APMX	Suitable for	Shim	Coolant	Shape	Weight (KG)	Stock
			DC	DCX	DCON	LF	KWW	KDP								
MFB145050R03A22SN12	50	3	50	63.5	22	40	10.4	6.3	3	SNE(M)U1206AN*N	✓	✓	Fig1	0.41	●	
MFB145063R04A22SN12	63	4	63	76.5	22	40	10.4	6.3	3	SNE(M)U1206AN*N	✓	✓	Fig1	0.60	●	
MFB145080R05A27SN12	80	5	80	93.5	27	50	12.4	7	3	SNE(M)U1206AN*N	✓	✓	Fig1	1.11	●	
MFB145080L05A27SN12	80	5	80	93.5	27	50	12.4	7	3	SNE(M)U1206AN*N	✓	✓	Fig1	1.11	●	
MFB145100R06B32SN12	100	6	100	113.5	32	50	14.4	8	3	SNE(M)U1206AN*N	✓	×	Fig2	1.51	●	
MFB145125R07B40SN12	125	7	125	138.5	40	63	16.4	9	3	SNE(M)U1206AN*N	✓	×	Fig2	2.99	●	
MFB145160R08C40SN12	160	8	160	173.5	40	63	16.4	9	3	SNE(M)U1206AN*N	✓	×	Fig3	4.39	●	
MFB145200R10C60SN12	200	10	200	213.5	60	63	25.7	14	3	SNE(M)U1206AN*N	✓	×	Fig3	6.37	●	
MFB145250R12C60SN12	250	12	250	263.5	60	63	25.7	14	3	SNE(M)U1206AN*N	✓	×	Fig3	9.50	○	
MFB145315R15D60SN12	315	15	315	328.5	60	80	25.7	14	3	SNE(M)U1206AN*N	✓	×	Fig4	18.08	○	

● Stock ○ Available Upon Order

Dense Pitch

Ordering Code	Dia-meter	Teeth	Dimension(mm)							APMX	Suitable for	Shim	Coolant	Shape	Weight (KG)	Stock
			DC	DCX	DCON	LF	KWW	KDP								
MFB145050R04A22SN12	50	4	50	63.5	22	40	10.4	6.3	3	SNE(M)U1206AN*N	✓	✓	Fig1	0.41	●	
MFB145050L04A22SN12	50	4	50	63.5	22	40	10.4	6.3	3	SNE(M)U1206AN*N	✓	✓	Fig1	0.41	●	
MFB145063R05A22SN12	63	5	63	76.5	22	40	10.4	6.3	3	SNE(M)U1206AN*N	✓	✓	Fig1	0.58	●	
MFB145080R07A27SN12	80	7	80	93.5	27	50	12.4	7	3	SNE(M)U1206AN*N	✓	✓	Fig1	1.13	●	
MFB145080L08A27SN12	80	8	80	93.5	27	50	12.4	7	3	SNE(M)U1206AN*N	✓	✓	Fig1	1.09	●	
MFB145100R08B32SN12	100	8	100	113.5	32	50	14.4	8	3	SNE(M)U1206AN*N	✓	×	Fig2	1.55	●	
MFB145125R10B40SN12	125	10	125	138.5	40	63	16.4	9	3	SNE(M)U1206AN*N	✓	×	Fig2	3.02	●	
MFB145160R12C40SN12	160	12	160	173.5	40	63	16.4	9	3	SNE(M)U1206AN*N	✓	×	Fig3	4.41	●	
MFB145160L12C40SN12	160	12	160	173.5	40	63	16.4	9	3	SNE(M)U1206AN*N	✓	×	Fig3	4.31	●	
MFB145200R14C60SN12	200	14	200	213.5	60	63	25.7	14	3	SNE(M)U1206AN*N	✓	×	Fig3	6.30	●	
MFB145200L14C60SN12	200	14	200	213.5	60	63	25.7	14	3	SNE(M)U1206AN*N	✓	×	Fig3	6.30	●	
MFB145250R16C60SN12	250	16	250	263.5	60	63	25.7	14	3	SNE(M)U1206AN*N	✓	×	Fig3	9.29	○	
MFB145315R20D60SN12	315	20	315	328.5	60	80	25.7	14	3	SNE(M)U1206AN*N	✓	×	Fig4	18.18	○	

● Stock ○ Available Upon Order

Face Milling

MFB145

Arbor(with Shim)

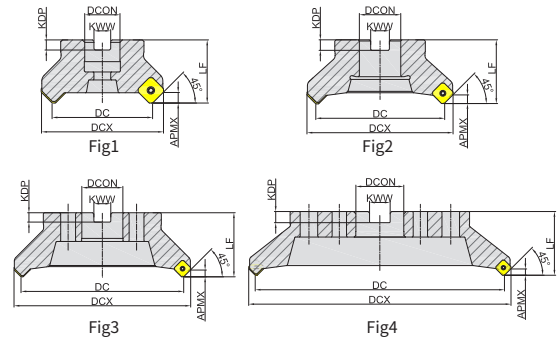

Extral Dense Teeth

Ordering Code	Dia- meter	Teeth	Dimension(mm)							APMX	Suitable for	Shim	Coolant	Shape	Weight (KG)	Stock
			DC	DCX	DCON	LF	KWW	KDP								
MFB145050R05A22SN12	50	5	50	63.5	22	40	10.4	6.3	3	SNE(M)U1206AN*N	✓	✓	Fig1	0.37	●	
MFB145063R06A22SN12	63	6	63	76.5	22	40	10.4	6.3	3	SNE(M)U1206AN*N	✓	✓	Fig1	0.57	●	
MFB145080R08A27SN12	80	8	80	93.5	27	50	12.4	7	3	SNE(M)U1206AN*N	✓	✓	Fig1	1.09	●	
MFB145100R10B32SN12	100	10	100	113.5	32	50	14.4	8	3	SNE(M)U1206AN*N	✓	×	Fig2	1.48	●	
MFB145125R12B40SN12	125	12	125	138.5	40	63	16.4	9	3	SNE(M)U1206AN*N	✓	×	Fig2	2.93	●	
MFB145160R15C40SN12	160	15	160	173.5	40	63	16.4	9	3	SNE(M)U1206AN*N	✓	×	Fig3	4.31	●	
MFB145200R18C60SN12	200	18	200	213.5	60	63	25.7	14	3	SNE(M)U1206AN*N	✓	×	Fig3	6.25	●	
MFB145200L18C60SN12	200	18	200	213.5	60	63	25.7	14	3	SNE(M)U1206AN*N	✓	×	Fig3	6.25	●	
MFB145250R21C60SN12	250	21	250	263.5	60	63	25.7	14	3	SNE(M)U1206AN*N	✓	×	Fig3	9.39	○	
MFB145315R24D60SN12	315	24	315	328.5	60	80	25.7	14	3	SNE(M)U1206AN*N	✓	×	Fig4	18.19	○	

● Stock ○ Available Upon Order

Face Milling

MFB145 NEW



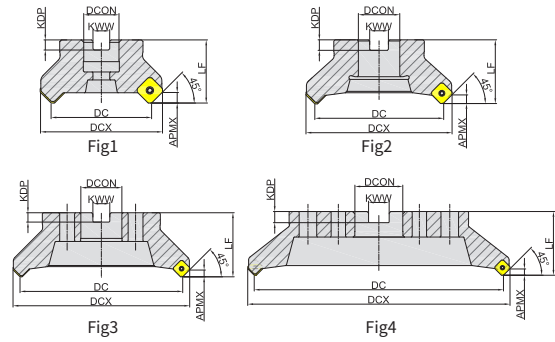

Arbor (with Shim and Unequal Teeth)

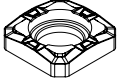

Ordering Code	Dia-meter	Teeth	Dimension(mm)						APMX	Suitable for	Shim	Coolant	Shape	Weight (KG)	Stock
			DC	DCX	DCON	LF	KWW	KDP							
MFB145050R03A22SN12U	50	3	50	63.5	22	40	10.4	6.3	3	SNE(M)U1206AN*N	✓	✓	Fig1	0.41	●
MFB145063R04A22SN12U	63	4	63	76.5	22	40	10.4	6.3	3	SNE(M)U1206AN*N	✓	✓	Fig1	0.60	●
MFB145080R05A27SN12U	80	5	80	93.5	27	50	12.4	7.0	3	SNE(M)U1206AN*N	✓	✓	Fig1	1.12	●
MFB145100R06B32SN12U	100	6	100	113.5	32	50	14.4	8.0	3	SNE(M)U1206AN*N	✓	×	Fig2	1.51	●
MFB145125R07B40SN12U	125	7	125	138.5	40	63	16.4	9.0	3	SNE(M)U1206AN*N	✓	×	Fig2	2.99	●
MFB145160R08C40SN12U	160	8	160	173.5	40	63	16.4	9.0	3	SNE(M)U1206AN*N	✓	×	Fig3	4.39	●
MFB145200R10C60SN12U	200	10	200	213.5	60	63	25.7	14	3	SNE(M)U1206AN*N	✓	×	Fig3	6.37	●
MFB145250R12C60SN12U	250	12	250	263.5	60	63	25.7	14	3	SNE(M)U1206AN*N	✓	×	Fig3	9.50	●
MFB145315R15D60SN12U	315	15	315	328.5	60	63	25.7	14	3	SNE(M)U1206AN*N	✓	×	Fig4	18.48	●

● Stock ○ Available Upon Order

Spare Parts

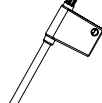
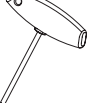
Part Name	Shim	Shim Screw	Wrench	Inserts Screw	Recommended Torque	Insert Screw Wrench
<div style="display: flex; align-items: center;"> <div style="writing-mode: vertical-rl; transform: rotate(180deg); margin-right: 10px;">Inserts</div> <div style="text-align: center;">  </div> </div>						
SNE(M)U1206	Ordering Code H0K30SSN12	SSAM060075B	TH40LB	SI60M040158-07108B	4.0N·m	TT15PB TT15TB

Face Milling

MFB245

Arbor(Without Shim)

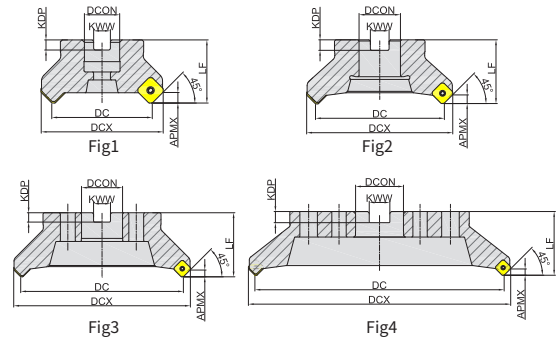
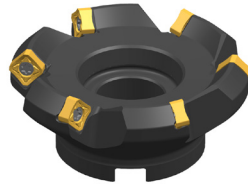

Sparse Pitch

Ordering Code	Dia-meter	Teeth	Dimension(mm)							APMX	Suitable for	Shim	Coolant	Shape	Weight (KG)	Stock
			DC	DCX	DCON	LF	KWW	KDP								
MFB245050R03A22SN12	50	3	50	63.5	22	40	10.4	6.3	3	SNE(M)U1206AN*N	×	✓	Fig1	0.43	●	
MFB245063R04A22SN12	63	4	63	76.5	22	40	10.4	6.3	3	SNE(M)U1206AN*N	×	✓	Fig1	0.64	●	
MFB245080R05A27SN12	80	5	80	93.5	27	50	12.4	7	3	SNE(M)U1206AN*N	×	✓	Fig1	1.16	●	
MFB245080L05A27SN12	80	5	80	93.5	27	50	12.4	7	3	SNE(M)U1206AN*N	×	✓	Fig1	1.16	●	
MFB245100R06B32SN12	100	6	100	113.5	32	50	14.4	8	3	SNE(M)U1206AN*N	×	×	Fig2	1.56	●	
MFB245100L06B32SN12	100	6	100	113.5	32	50	14.4	8	3	SNE(M)U1206AN*N	×	×	Fig2	1.56	●	
MFB245125R07B40SN12	125	7	125	138.5	40	63	16.4	9	3	SNE(M)U1206AN*N	×	×	Fig2	3.12	●	
MFB245160R08C40SN12	160	8	160	173.5	40	63	16.4	9	3	SNE(M)U1206AN*N	×	×	Fig3	4.53	●	
MFB245200R10C60SN12	200	10	200	213.5	60	63	25.7	14	3	SNE(M)U1206AN*N	×	×	Fig3	6.56	●	
MFB245250R12C60SN12	250	12	250	263.5	60	63	25.7	14	3	SNE(M)U1206AN*N	×	×	Fig3	9.68	○	
MFB245315R15D60SN12	315	15	315	328.5	60	80	25.7	14	3	SNE(M)U1206AN*N	×	×	Fig4	18.65	○	

● Stock ○ Available Upon Order

Dense Pitch

Ordering Code	Dia-meter	Teeth	Dimension(mm)							APMX	Suitable for	Shim	Coolant	Shape	Weight (KG)	Stock
			DC	DCX	DCON	LF	KWW	KDP								
MFB245050R04A22SN12	50	4	50	63.5	22	40	10.4	6.3	3	SNE(M)U1206AN*N	×	✓	Fig1	0.40	●	
MFB245050L04A22SN12	50	4	50	63.5	22	40	10.4	6.3	3	SNE(M)U1206AN*N	×	✓	Fig1	0.40	●	
MFB245063R05A22SN12	63	5	63	76.5	22	40	10.4	6.3	3	SNE(M)U1206AN*N	×	✓	Fig1	0.60	●	
MFB245063L05A22SN12	63	5	63	76.5	22	40	10.4	6.3	3	SNE(M)U1206AN*N	×	✓	Fig1	0.60	●	
MFB245080R07A27SN12	80	7	80	93.5	27	50	12.4	7	3	SNE(M)U1206AN*N	×	✓	Fig1	1.10	●	
MFB245080L07A27SN12	80	7	80	93.5	27	50	12.4	7	3	SNE(M)U1206AN*N	×	✓	Fig1	1.10	●	
MFB245100R08B32SN12	100	8	100	113.5	32	50	14.4	8	3	SNE(M)U1206AN*N	×	×	Fig2	1.50	●	
MFB245100L08B32SN12	100	8	100	113.5	32	50	14.4	8	3	SNE(M)U1206AN*N	×	×	Fig2	1.50	●	
MFB245125R10B40SN12	125	10	125	138.5	40	63	16.4	9	3	SNE(M)U1206AN*N	×	×	Fig2	2.99	●	
MFB245125L10B40SN12	125	10	125	138.5	40	63	16.4	9	3	SNE(M)U1206AN*N	×	×	Fig2	2.99	●	
MFB245160R12C40SN12	160	12	160	173.5	40	63	16.4	9	3	SNE(M)U1206AN*N	×	×	Fig3	4.37	●	
MFB245160L12C40SN12	160	12	160	173.5	40	63	16.4	9	3	SNE(M)U1206AN*N	×	×	Fig3	4.37	●	
MFB245200R14C60SN12	200	14	200	213.5	60	63	25.7	14	3	SNE(M)U1206AN*N	×	×	Fig3	6.36	●	
MFB245200L14C60SN12	200	14	200	213.5	60	63	25.7	14	3	SNE(M)U1206AN*N	×	×	Fig3	6.36	●	
MFB245250R16C60SN12	250	16	250	263.5	60	63	25.7	14	3	SNE(M)U1206AN*N	×	×	Fig3	9.39	○	
MFB245250L16C60SN12	250	16	250	263.5	60	63	25.7	14	3	SNE(M)U1206AN*N	×	×	Fig3	9.39	○	
MFB245315R20D60SN12	315	20	315	328.5	60	80	25.7	14	3	SNE(M)U1206AN*N	×	×	Fig4	18.31	○	
MFB245315L20D60SN12	315	20	315	328.5	60	80	25.7	14	3	SNE(M)U1206AN*N	×	×	Fig4	18.31	○	

● Stock ○ Available Upon Order

Face Milling

MFB245

Arbor(Without Shim)

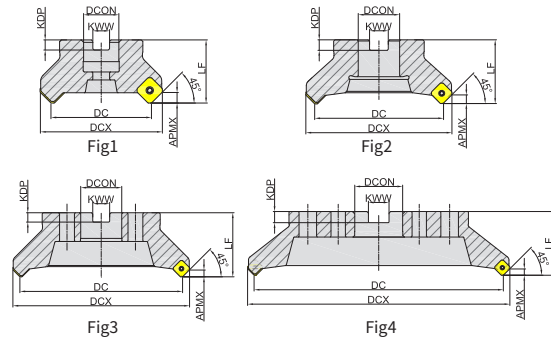

Extral Dense Teeth

Ordering Code	Dia-meter	Teeth	Dimension(mm)							APMX	Suitable for	Shim	Coolant	Shape	Weight (KG)	Stock
			DC	DCX	DCON	LF	KWW	KDP								
MFB245050R05A22SN12	50	5	50	63.5	22	40	10.4	6.3	3	SNE(M)U1206AN*N	×	✓	Fig1	0.38	●	
MFB245063R06A22SN12	63	6	63	76.5	22	40	10.4	6.3	3	SNE(M)U1206AN*N	×	✓	Fig1	0.59	●	
MFB245080R08A27SN12	80	8	80	93.5	27	50	12.4	7	3	SNE(M)U1206AN*N	×	✓	Fig1	1.08	●	
MFB245100R10B32SN12	100	10	100	113.5	32	50	14.4	8	3	SNE(M)U1206AN*N	×	×	Fig2	1.45	●	
MFB245125R12B40SN12	125	12	125	138.5	40	63	16.4	9	3	SNE(M)U1206AN*N	×	×	Fig2	2.95	●	
MFB245160R15C40SN12	160	15	160	173.5	40	63	16.4	9	3	SNE(M)U1206AN*N	×	×	Fig3	4.29	●	
MFB245200R18C60SN12	200	18	200	213.5	60	63	25.7	14	3	SNE(M)U1206AN*N	×	×	Fig3	6.32	●	
MFB245200R20C60SN12	200	20	200	213.5	60	63	25.7	14	3	SNE(M)U1206AN*N	×	×	Fig3	6.30	●	
MFB245250R21C60SN12	250	21	250	263.5	60	63	25.7	14	3	SNE(M)U1206AN*N	×	×	Fig3	9.39	○	
MFB245315R24D60SN12	315	24	315	328.5	60	80	25.7	14	3	SNE(M)U1206AN*N	×	×	Fig4	18.28	○	

● Stock ○ Available Upon Order

Face Milling

MFB245 NEW

Arbor(Without Shim)

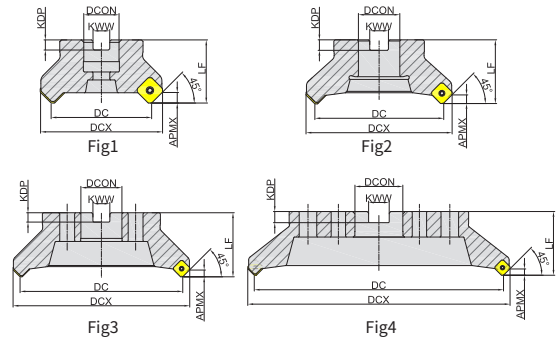

Ordering Code	Dia-meter	Teeth	Dimension(mm)							APMX	Suitable for	Shim	Coolant	Shape	Weight (KG)	Stock
			DC	DCX	DCON	LF	KWW	KDP								
MFB245050R03A22SN12U	50	3	50	63.5	22	40	10.4	6.3	3	SNE(M)U1206AN*N	×	✓	Fig1	0.43	●	
MFB245063R04A22SN12U	63	4	63	76.5	22	40	10.4	6.3	3	SNE(M)U1206AN*N	×	✓	Fig1	0.64	●	
MFB245080R05A27SN12U	80	5	80	93.5	27	50	12.4	7.0	3	SNE(M)U1206AN*N	×	✓	Fig1	1.16	●	
MFB245100R06B32SN12U	100	6	100	113.5	32	50	14.4	8.0	3	SNE(M)U1206AN*N	×	×	Fig2	1.56	●	
MFB245125R07B40SN12U	125	7	125	138.5	40	63	16.4	9.0	3	SNE(M)U1206AN*N	×	×	Fig2	3.12	●	
MFB245160R08C40SN12U	160	8	160	173.5	40	63	16.4	9.0	3	SNE(M)U1206AN*N	×	×	Fig3	4.53	●	
MFB245200R10C60SN12U	200	10	200	213.5	60	63	25.7	14	3	SNE(M)U1206AN*N	×	×	Fig3	6.56	●	
MFB245250R12C60SN12U	250	12	250	263.5	60	63	25.7	14	3	SNE(M)U1206AN*N	×	×	Fig3	9.68	●	
MFB245315R15D60SN12U	315	15	315	328.5	60	80	25.7	14	3	SNE(M)U1206AN*N	×	×	Fig4	18.65	●	

● Stock ○ Available Upon Order

Spare Parts

Part Name		Inserts Screw	Recommended Torque	Insert Screw Wrench	
Inserts	Shape				
	Ordering Code	S183M050140-07010IB	5.0N·m	T120PB	T120TB

Face Milling

MFB275

Arbor(Without Shim)

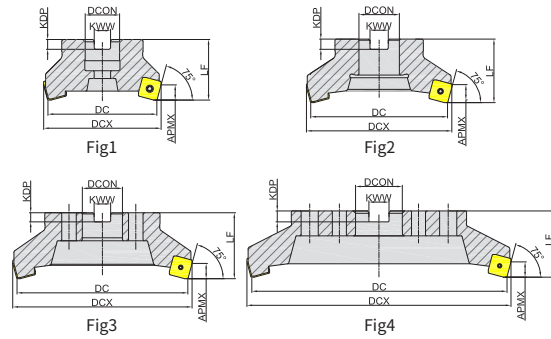
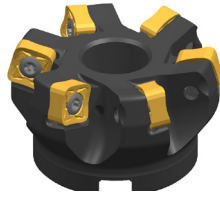

Ordering Code	Dia-meter	Teeth	Dimension(mm)							APMX	Suitable for	Shim	Coolant	Shape	Weight (KG)	Stock
			DC	DCX	DCON	LF	KWW	KDP								
MFB275050R04A22SN12	50	4	50	55	22	40	10.4	6.3	5	SNE(M)U1206ENEN	×	✓	Fig1	0.31	●	
MFB275063R05A22SN12	63	5	63	68	22	40	10.4	6.3	5	SNE(M)U1206ENEN	×	✓	Fig1	0.53	●	
MFB275063R06A22SN12	63	6	63	68	22	40	10.4	6.3	5	SNE(M)U1206ENEN	×	✓	Fig1	0.55	●	
MFB275080R07A27SN12	80	7	80	85	27	50	12.4	7	5	SNE(M)U1206ENEN	×	✓	Fig1	1.04	●	
MFB275100R08B32SN12	100	8	100	105	32	50	14.4	8	5	SNE(M)U1206ENEN	×	×	Fig2	1.41	●	
MFB275125R10B40SN12	125	10	125	130	40	63	16.4	9	5	SNE(M)U1206ENEN	×	×	Fig2	2.81	●	
MFB275160R12C40SN12	160	12	160	165	40	63	16.4	9	5	SNE(M)U1206ENEN	×	×	Fig3	3.95	●	
MFB275200R14C60SN12	200	14	200	205	60	63	25.7	14	5	SNE(M)U1206ENEN	×	×	Fig3	6.33	●	
MFB275250R16C60SN12	250	16	250	255	60	63	25.7	14	5	SNE(M)U1206ENEN	×	×	Fig3	10.27	○	
MFB275315R20D60SN12	315	20	315	320	60	80	25.7	14	5	SNE(M)U1206ENEN	×	×	Fig4	18.97	○	

● Stock ○ Available Upon Order

Spare Parts

Part Name		Inserts Screw	Recommended Torque	Insert Screw Wrench	
Inserts	Shape				
	Ordering Code	SI83M050140-07010IB	5.0N·m	T120PB	T120TB

Face Milling

MFB288

Arbor(Without Shim)

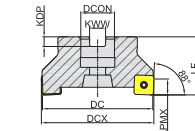

Fig1

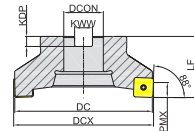

Fig2

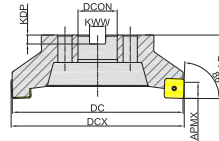

Fig3

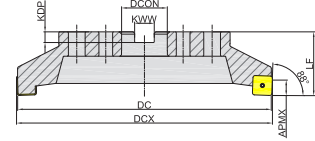

Fig4

Ordering Code	Dia-meter	Teeth	Dimension(mm)							APMX	Suitable for	Shim	Coolant	Shape	Weight (KG)	Stock
			DC	DCX	DCON	LF	KWW	KDP								
MFB288050R04A22SN12	50	4	50	51	22	40	10.4	6.3	7	SNE(M)U1206ZNEN	×	✓	Fig1	0.30	●	
MFB288063R05A22SN12	63	5	63	64	22	40	10.4	6.3	7	SNE(M)U1206ZNEN	×	✓	Fig1	0.41	●	
MFB288063L05A22SN12	63	5	63	64	22	40	10.4	6.3	7	SNE(M)U1206ZNEN	×	✓	Fig1	0.50	●	
MFB288063R06A22SN12	63	6	63	64	22	40	10.4	6.3	7	SNE(M)U1206ZNEN	×	✓	Fig1	0.49	●	
MFB288080R05A27SN12	80	5	80	81	27	50	12.4	7	7	SNE(M)U1206ZNEN	×	✓	Fig1	0.99	●	
MFB288080R07A27SN12	80	7	80	81	27	50	12.4	7	7	SNE(M)U1206ZNEN	×	✓	Fig1	0.92	●	
MFB288080L07A27SN12	80	7	80	81	27	50	12.4	7	7	SNE(M)U1206ZNEN	×	✓	Fig1	0.92	●	
MFB288100R08B32SN12	100	8	100	101	32	50	14.4	8	7	SNE(M)U1206ZNEN	×	×	Fig2	1.29	●	
MFB288125R10B40SN12	125	10	125	126	40	63	16.4	9	7	SNE(M)U1206ZNEN	×	×	Fig2	2.88	●	
MFB288160R12C40SN12	160	12	160	161	40	63	16.4	9	7	SNE(M)U1206ZNEN	×	×	Fig3	3.86	●	
MFB288200R14C60SN12	200	14	200	201	60	63	25.7	14	7	SNE(M)U1206ZNEN	×	×	Fig3	6.00	●	
MFB288250R16C60SN12	250	16	250	251	60	63	25.7	14	7	SNE(M)U1206ZNEN	×	×	Fig3	9.64	○	
MFB288315R20D60SN12	315	20	315	316	60	80	25.7	14	7	SNE(M)U1206ZNEN	×	×	Fig4	16.96	○	

● Stock ○ Available Upon Order

Face Milling

MFB288

Arbor(Without Shim)

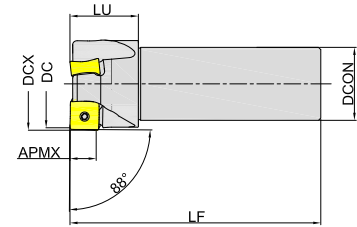
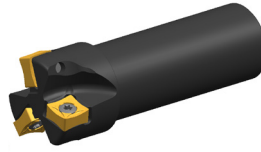

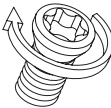
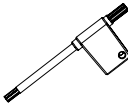



Fig5

Ordering Code	Dia- meter	Teeth	Dimension(mm)					APMX	Suitable for	Shim	Coolant	Shape	Weight (KG)	Stock
			DC	DCX	DCON	LF	LU							
MFB288040R03P32SN12	40	3	40	41	32	110	30	7	SNE(M)U1206ZNE	×	✓	Fig5	0.67	●

● Stock ○ Available Upon Order

Spare Parts

Part Name		Inserts Screw	Recommended Torque	Insert Screw Wrench	
Inserts	Shape				
	Ordering Code	SI83M050140-07010IB	5.0N·m	T120PB	T120TB

Recommended Cutting Data





Workpiece	Hardness	Grade	Specification	Ap (mm)	Cutting Speed Vc(m/min)	Feed Rate/Edges fz(mm)			
						Light Cutting(L)	Medium Cutting(M)	Heavy Cutting(H)	
P	Soft Steel	≤ HB180	GPM7120 GA4225 GA4230	SNE(M)U1206ANEN	1.5	250 (210-290)	0.2 (0.1-0.3)	0.25 (0.15-0.35)	0.3 (0.2-0.4)
				SNE(M)U1206ENEN	2.5				
				SNE(M)U1206ZNEN	3.5				
	Carbon Steel, Alloy Steel	HB180-350	GPM7120 GA4225 GA4230 GP2115	SNE(M)U1206ANEN	1.5	220 (180-260)	0.15 (0.1-0.2)	0.25 (0.15-0.35)	0.3 (0.2-0.4)
				SNE(M)U1206ENEN	2.5				
				SNE(M)U1206ZNEN	3.5				
	Pre-harden Steel	HRC35-45	GPM7120 GA4230 GA4225 GP2115	SNE(M)U1206ANEN	1.5	140 (100-180)	0.1 (0.05-0.15)	0.15 (0.1-0.2)	0.2 (0.1-0.3)
				SNE(M)U1206ENEN	2.5				
				SNE(M)U1206ZNEN	3.5				
M	Stainless (Ferrite, Martensite)	≤ HB270	GM2140 GM4135 GA4230	SNE(M)U1206ANEN	1.5	180 (140-220)	0.15 (0.1-0.2)	0.25 (0.15-0.35)	0.3 (0.2-0.4)
				SNE(M)U1206ENEN	2.5				
				SNE(M)U1206ZNEN	3.5				
	Stainless (Austenite, Diphasic)	≤ HB270	GM2140 GM4135	SNE(M)U1206ANEN	1.5	160 (120-200)	0.1 (0.05-0.15)	0.15 (0.1-0.2)	0.2 (0.1-0.3)
				SNE(M)U1206ENEN	2.5				
				SNE(M)U1206ZNEN	3.5				
K	Grey Cast Iron	≤ HB280	GK2115 GK4125	SNE(M)U1206ANEN	1.5	180 (140-220)	0.15 (0.1-0.2)	0.2 (0.1-0.3)	0.3 (0.2-0.4)
				SNE(M)U1206ENEN	2.5				
				SNE(M)U1206ZNEN	3.5				
	Nodular Cast Iron, Vermicular Graphite Cast Iron	≤ HB350	GK4125 GK2115	SNE(M)U1206ANEN	1.5	160 (120-200)	0.15 (0.1-0.2)	0.2 (0.1-0.3)	0.3 (0.2-0.4)
				SNE(M)U1206ENEN	2.5				
				SNE(M)U1206ZNEN	3.5				
N	Aluminium	HB60-210	GN9125	SNEU1206ANFN	1.5	≥ 300	0.15 (0.1-0.2)	0.2 (0.1-0.3)	—
S	Heat-resistant Alloy and Titanium Alloy	HRC30-45	GS4130	SNE(M)U1206ANEN	1.5	40 (30-60)	0.15 (0.1-0.2)	0.2 (0.1-0.3)	—
				SNE(M)U1206ENEN	2.5				
				SNE(M)U1206ZNEN	3.5				

Face Milling

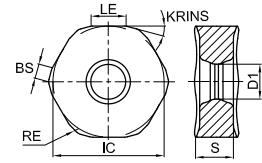
HNGU **NEW**

Negative Twelve Edge Face Milling Insert

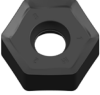

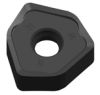







Ordering Code	Dimension(mm)							Coating Grade										Uncoated	Cermet			
	LE	IC	S	BS	D1	KRINS	RE	GA4225	GA4230	GA4325	GPM7120	GP4225	GP2115	GM4135	GM2140	GK4125	GK2115			GS4130	GH4115	GN9125
	HNGU0604ANEN-GL	3.4	12	4.44	1.1	4.9	15°	1.0				●	●	○	●	●	●	○				
	HNGU0905ANEN-GL	4.6	15.88	5.52	1.35	5	15°	1.2				●	●	●	●	●	●	●				
	HNGU060432-GL	3.4	12	4.44	—	4.9	—	3.2				●	○	○	○	○	○	○				
	HNGU0604ANEN-GM	3.4	12	4.48	1.1	4.9	15°	1.0				●	●	●	●	●	●	●				
	HNGU0905ANEN-GM	4.6	15.88	5.56	1.35	5	15°	1.2				●	●	●	●	●	●	●				
	HNGU1307ANEN-GM	7.3	22.25	7.48	1.65	7.95	15°	1.3				○	●	○	○	●	●	●	○			
	HNGU130720-GM	10.5	22.25	7.48	—	7.95	—	2.0				○	●	○	○	○	○	○				
	HNGU0604ANEN-GH	3.4	12	4.48	1.1	4.9	15°	1.0				●			●	●	●					
	HNGU0905ANEN-GH	4.6	15.88	5.56	1.35	5	15°	1.2				●			●	●	●					
	HNGU1307ANEN-GH	7.3	22.25	7.48	1.65	7.95	15°	1.3				●			●	●	●					
	HNGU060432-GH	3.4	12	4.48	—	4.9	—	3.2				●			○	○						
	HNGU090543-GH	4.2	15.88	5.56	—	5	—	4.3				●			○	○						
	HNGU130720-GH	10.5	22.25	7.48	—	7.95	—	2.0				●			○	○						
	HNGU130735-GH	8.8	22.25	7.48	—	7.95	—	3.5				●			○	○						
	★ HNGU0604ANFN-GW	5.6	12	4.53	4.8	4.9	15°	1.2				●			○							
	★ HNGU0905ANFN-GW	7.8	15.88	5.54	6.1	5	15°	1.6				●			○							

Note:

★ The HNGU****ANFN-GW insert only corresponds to the MFC145 series of holders.

● Stock ○ Available Upon Order

HNGU Series Geometry

Light Cutting for General Material	Medium Cutting For General Material	Heavy Cutting For General Material	Wiper
			
GL	GM	GH	GW
			
Big rake angle, sharper edge.	In general circumstances, high stability machining is realized.	High strength cutting edge, suitable for interrupted cuts and roughing.	Specialized wiper insert. It can improve the machining surface quality.

Face Milling

MFC115

Arbor

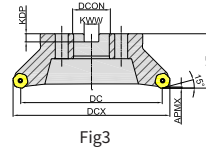
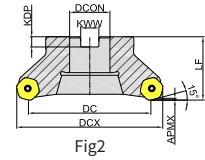
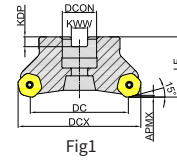
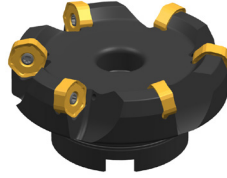

Ordering Code	Dia-meter	Teeth	Dimension(mm)							APMX	Suitable for	Coolant	Shape	Weight (KG)	Stock
			DC	DCX	DCON	LF	KWW	KDP							
MFC115040R05A16HN06	40	5	40	53	16	40	8.4	5.6	1.6	HNGU0604	✓	Fig1	0.30	●	
MFC115050R04A22HN09	50	4	50	67.7	22	40	10.4	6.3	2.2	HNGU0905	✓	Fig1	0.40	●	
MFC115050R05A22HN06	50	5	50	63	22	40	10.4	6.3	1.6	HNGU0604	✓	Fig1	0.40	●	
MFC115063R05A22HN09	63	5	63	80.7	22	40	10.4	6.3	2.2	HNGU0905	✓	Fig1	0.65	●	
MFC115063R06A22HN06	63	6	63	76	22	40	10.4	6.3	1.6	HNGU0604	✓	Fig1	0.63	●	
MFC115080R06A27HN09	80	6	80	97.7	27	50	12.4	7	2.2	HNGU0905	✓	Fig1	1.33	●	
MFC115080R08A27HN06	80	8	80	93	27	50	12.4	7	1.6	HNGU0604	✓	Fig1	1.34	●	
MFC115100R08B32HN09	100	8	100	117.7	32	50	14.5	8	2.2	HNGU0905	×	Fig2	1.83	●	
MFC115125R09B40HN09	125	9	125	142.7	40	63	16.4	9	2.2	HNGU0905	×	Fig2	3.39	●	
MFC115160R12C40HN09	160	12	160	177.7	40	63	16.4	9	2.2	HNGU0905	×	Fig3	4.83	●	

● Stock ○ Available Upon Order

MFC115

Cylindrical Straight Type

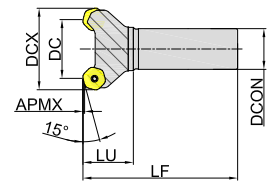

Ordering Code	Dia-meter	Teeth	Dimension(mm)						APMX	Suitable for	Coolant	Shape	Weight (KG)	Stock
			DC	DCX	DCON	LF	LU							
MFC115025R03P20HN06	25	3	25	38.2	20	120	32	1.6	HNGU0604	✓	Fig4	0.32	●	
MFC115032R03P25HN06	32	3	32	45	25	130	40	1.6	HNGU0604	✓	Fig4	0.54	●	

● Stock ○ Available Upon Order

Face Milling

MFC115

Replaceable Tool Head

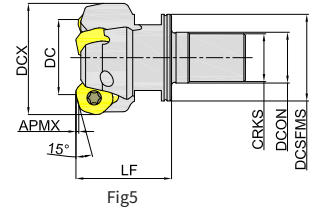

Ordering Code	Dia-meter	Teeth	Dimension(mm)						APMX	Suitable for	Coolant	Shape	Weight (KG)	Stock
			DC	DCX	DCON	DCSFMS	LF	CRKS						
MFC115025R03M16HN06	25	3	25	38.2	17	29	32	M16	1.6	HNGU0604	✓	Fig5	0.17	●
MFC115032R03M16HN06	32	3	32	45	17	29	40	M16	1.6	HNGU0604	✓	Fig5	0.26	●

● Stock ○ Available Upon Order

Spare Parts

Part Name		Inserts Screw	Recommended Torque	Insert Screw Wrench	
Inserts	Shape				
	Ordering Code	SR30M040100K	3.5N·m	TT15PQ	TT15TQ
	Ordering Code	SR30M040100K	3.5N·m	TT15PQ	TT15TQ

Face Milling

MFC145

Arbor

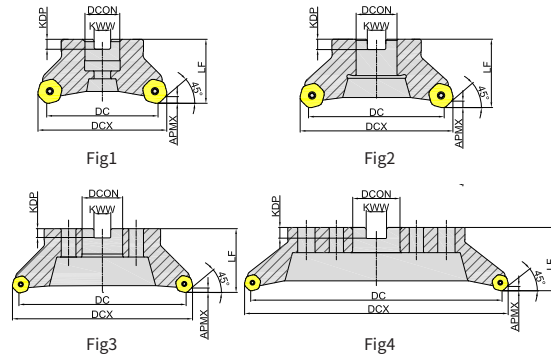
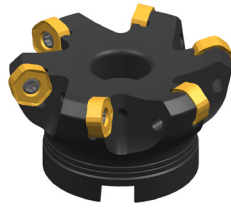

Sparse Pitch

Ordering Code	Dia-meter	Teeth	Dimension(mm)							APMX	Suitable for	Coolant	Shape	Weight (KG)	Stock
			DC	DCX	DCON	LF	KWW	KDP							
MFC145040R04A16HN06	40	4	40	48	16	40	8.4	5.6	3.2	HNGU0604	✓	Fig1	0.24	●	
MFC145050R04A22HN06	50	4	50	58	22	40	10.4	6.3	3.2	HNGU0604	✓	Fig1	0.30	●	
MFC145050R04A22HN09	50	4	50	60.6	22	40	10.4	6.3	4.5	HNGU0905	✓	Fig1	0.28	●	
MFC145063R04A22HN06	63	4	63	71	22	40	10.4	6.3	3.2	HNGU0604	✓	Fig1	0.51	●	
MFC145063R05A22HN09	63	5	63	73.6	22	40	10.4	6.3	4.5	HNGU0905	✓	Fig1	0.50	●	
MFC145080R04A27HN13	80	4	80	95.4	27	50	12.4	7	8.0	HNGU1307	✓	Fig1	1.04	●	
MFC145080R05A27HN06	80	5	80	88	27	50	12.4	7	3.2	HNGU0604	✓	Fig1	1.16	●	
MFC145080R05A27HN09	80	5	80	90.6	27	50	12.4	7	4.5	HNGU0905	✓	Fig1	1.13	●	
MFC145100R05B32HN13	100	5	100	115.4	32	50	14.5	8	8.0	HNGU1307	×	Fig2	1.50	●	
MFC145100R06B32HN06	100	6	100	108	32	50	14.5	8	3.2	HNGU0604	×	Fig2	1.64	●	
MFC145100R06B32HN09	100	6	100	110.6	32	50	14.5	8	4.5	HNGU0905	×	Fig2	1.66	●	
MFC145125R06B40HN13	125	6	125	140.4	40	63	16.4	9	8.0	HNGU1307	×	Fig2	2.95	●	
MFC145125R08B40HN06	125	8	125	133	40	63	16.4	9	3.2	HNGU0604	×	Fig2	3.01	●	
MFC145125R08B40HN09	125	8	125	135.6	40	63	16.4	9	4.5	HNGU0905	×	Fig2	3.10	●	
MFC145160R09C40HN13	160	9	160	175.4	40	63	16.4	9	8.0	HNGU1307	×	Fig3	4.16	●	
MFC145160R10C40HN09	160	10	160	170.6	40	63	16.4	9	4.5	HNGU0905	×	Fig3	4.08	●	
MFC145200R12C60HN13	200	12	200	215.4	60	63	25.7	14	8.0	HNGU1307	×	Fig3	5.89	●	
MFC145200R16C60HN09	200	16	200	210.6	60	63	25.7	14	4.5	HNGU0905	×	Fig3	5.70	●	
MFC145250R12C60HN13	250	12	250	265.4	60	63	25.7	14	8.0	HNGU1307	×	Fig3	11.71	●	
MFC145250R20C60HN09	250	20	250	260.6	60	63	25.7	14	4.5	HNGU0905	×	Fig3	11.53	●	
MFC145250L20C60HN09	250	20	250	260.6	60	63	25.7	14	4.5	HNGU0905	×	Fig3	11.53	○	
MFC145315R14D60HN13	315	14	315	330.4	60	80	25.7	14	8.0	HNGU1307	×	Fig4	17.11	●	
MFC145315R24D60HN09	315	24	315	325.6	60	80	25.7	14	4.5	HNGU0905	×	Fig4	16.81	●	

● Stock ○ Available Upon Order

Face Milling

MFC145

Arbor

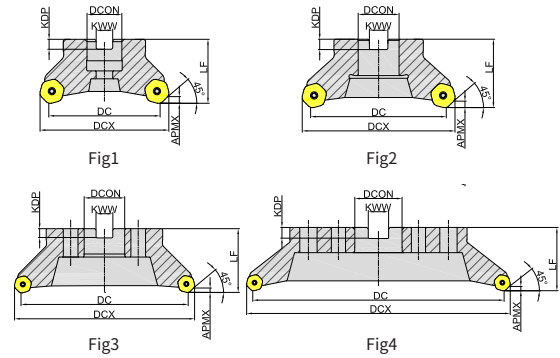
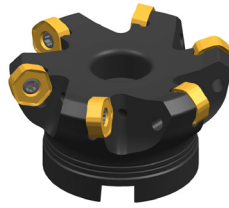

Dense Pitch

Ordering Code	Dia-meter	Teeth	Dimension(mm)							APMX	Suitable for	Coolant	Shape	Weight (KG)	Stock
			DC	DCX	DCON	LF	KWW	KDP							
MFC145040R05A16HN06	40	5	40	48	16	40	8.4	5.6	3.2	HNGU0604	✓	Fig1	0.23	●	
MFC145050R05A22HN06	50	5	50	58	22	40	10.4	6.3	3.2	HNGU0604	✓	Fig1	0.28	●	
MFC145050R05A22HN09	50	5	50	60.6	22	40	10.4	6.3	4.5	HNGU0905	✓	Fig1	0.27	●	
MFC145050R06A22HN06	50	6	50	58	22	40	10.4	6.3	3.2	HNGU0604	✓	Fig1	0.30	●	
MFC145063R06A22HN06	63	6	63	71	22	40	10.4	6.3	3.2	HNGU0604	✓	Fig1	0.48	●	
MFC145063R06A22HN09	63	6	63	73.6	22	40	10.4	6.3	4.5	HNGU0905	✓	Fig1	0.47	●	
MFC145063R07A22HN09	63	7	63	73.6	22	40	10.4	6.3	4.5	HNGU0905	✓	Fig1	0.47	●	
MFC145063R08A22HN06	63	8	63	71	22	40	10.4	6.3	3.2	HNGU0604	✓	Fig1	0.49	●	
MFC145080R06A27HN09	80	6	80	90.6	27	50	12.4	7	4.5	HNGU0905	✓	Fig1	1.10	●	
MFC145080R08A27HN06	80	8	80	88	27	50	12.4	7	3.2	HNGU0604	✓	Fig1	1.12	●	
MFC145080R09A27HN09	80	9	80	90.6	27	50	12.4	7	4.5	HNGU0905	✓	Fig1	1.05	●	
MFC145080R10A27HN06	80	1	80	88	27	50	12.4	7	3.2	HNGU0604	✓	Fig1	1.11	●	
MFC145100R08B32HN09	100	8	100	110.6	32	50	14.5	8	4.5	HNGU0905	×	Fig2	1.59	●	
MFC145100R09A32HN06	100	9	100	108	32	50	14.5	8	3.2	HNGU0604	✓	Fig1	1.80	●	
MFC145100R09B32HN06	100	9	100	108	32	50	14.5	8	3.2	HNGU0604	×	Fig2	1.61	●	
MFC145100R11B32HN09	100	11	100	110.6	32	50	14.5	8	4.5	HNGU0905	×	Fig2	1.56	●	
MFC145100R12A32HN06	100	12	100	108	32	50	14.5	8	3.2	HNGU0604	✓	Fig1	1.80	●	
MFC145100R12B32HN06	100	12	100	108	32	50	14.5	8	3.2	HNGU0604	×	Fig2	1.61	●	
MFC145125R10B40HN09	125	10	125	135.6	40	63	16.4	9	4.5	HNGU0905	×	Fig2	3.06	●	
MFC145125R12B40HN06	125	12	125	133	40	63	16.4	9	3.2	HNGU0604	×	Fig2	3.01	●	
MFC145125R14B40HN09	125	14	125	135.6	40	63	16.4	9	4.5	HNGU0905	×	Fig2	3.01	●	
MFC145125R16B40HN06	125	16	125	133	40	63	16.4	9	3.2	HNGU0604	×	Fig2	3.05	●	
MFC145160R12C40HN09	160	12	160	170.6	40	63	16.4	9	4.5	HNGU0905	×	Fig3	4.20	●	
MFC145160R16C40HN09	160	16	160	170.6	40	63	16.4	9	4.5	HNGU0905	×	Fig3	4.25	●	
MFC145200R10C60HN13	200	10	200	215.4	60	63	25.7	14	8.0	HNGU1307	×	Fig3	5.81	●	
MFC145250R14C60HN13	250	14	250	265.4	60	63	25.7	14	8.0	HNGU1307	×	Fig3	11.44	●	
MFC145315R18D60HN13	315	18	315	330.4	60	80	25.7	14	8.0	HNGU1307	×	Fig4	16.97	●	

● Stock ○ Available Upon Order

Face Milling

MFC145

Cylindrical Straight Type

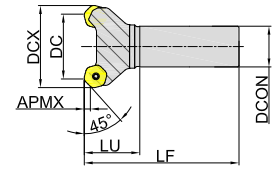

Fig5

Sparse Pitch

Ordering Code	Dia-meter	Teeth	Dimension(mm)					APMX	Suitable for	Coolant	Shape	Weight (KG)	Stock
			DC	DCX	DCON	LF	LU						
MFC145025R02P20HN06	25	2	25	33	20	120	32	3.2	HNGU0604	✓	Fig5	0.30	●
MFC145025R03P25HN06L	25	3	25	33	20	200	32	3.2	HNGU0604	✓	Fig5	0.73	●
MFC145032R03P25HN06	32	3	32	40	25	130	40	3.2	HNGU0604	✓	Fig5	0.51	●
MFC145040R03P25HN09	40	3	40	50.7	25	107	50	4.5	HNGU0905	✓	Fig5	0.60	●
MFC145025R03P20HN06	25	3	25	33	20	120	32	3.2	HNGU0604	✓	Fig5	0.29	●
MFC145032R04P25HN06	32	4	32	40	25	130	40	3.2	HNGU0604	✓	Fig5	0.50	●
MFC145040R04P25HN09	40	4	40	50.7	25	107	50	4.5	HNGU0905	✓	Fig5	0.57	●

● Stock ○ Available Upon Order

MFC145

Side Clamp Type

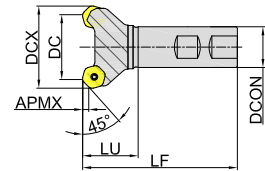

Fig6

Ordering Code	Dia-meter	Teeth	Dimension(mm)					APMX	Suitable for	Coolant	Shape	Weight (KG)	Stock
			DC	DCX	DCON	LF	LU						
MFC145025R03W20HN06	25	3	25	33	20	82	32	3.2	HNGU0604	✓	Fig6	0.21	●
MFC145032R03W25HN06	32	3	32	40	25	97	40	3.2	HNGU0604	✓	Fig6	0.41	●
MFC145040R03W25HN09	40	3	40	50.6	25	107	50	4.5	HNGU0905	✓	Fig6	0.59	●
MFC145032R04W25HN06	32	4	32	40	25	97	40	3.2	HNGU0604	✓	Fig6	0.39	●
MFC145040R04W25HN09	40	4	40	50.6	25	107	50	4.5	HNGU0905	✓	Fig6	0.57	●

● Stock ○ Available Upon Order

Face Milling

MFC145

Replaceable Tool Head

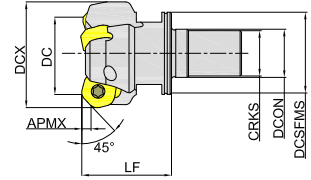

Fig7

Ordering Code	Dia-meter	Teeth	Dimension(mm)							APMX	Suitable for	Coolant	Shape	Weight (KG)	Stock
			DC	DCX	DCON	DCSFMS	LF	CRKS							
MFC145025R03M16HN06	25	3	25	33	17	29	32	M16	3.2	HNGU0604	✓	Fig7	0.15	●	
MFC145032R03M16HN06	32	3	32	40	17	29	40	M16	3.2	HNGU0604	✓	Fig7	0.22	●	
MFC145032R04M16HN06	32	4	32	40	17	29	40	M16	3.2	HNGU0604	✓	Fig7	0.19	●	

● Stock ○ Available Upon Order

Spare Parts

Part Name		Inserts Screw	Recommended Torque	Insert Screw Wrench	
Inserts	Shape				
	HNGU0604	Ordering Code SR30M040100K	3.5N·m	TT15PQ	TT15TQ
	HNGU0905	Ordering Code SR30M040100K	3.5N·m	TT15PQ	TT15TQ
	HNGU1307	Ordering Code SR45M060160IK	8.0N·m	—	TI25TQ

Face Milling

MFC160

Arbor

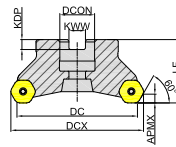
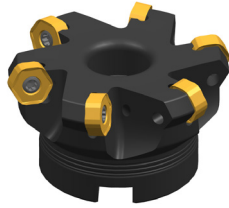

Fig1

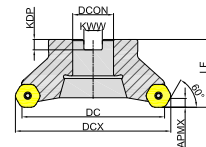

Fig2

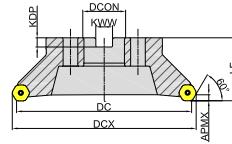

Fig3

Sparse Pitch

Ordering Code	Dia-meter	Teeth	Dimension(mm)							APMX	Suitable for	Coolant	Shape	Weight (KG)	Stock
			DC	DCX	DCON	LF	KWW	KDP							
MFC160040R04A16HN06	40	4	40	46.1	16	40	8.4	5.6	4.3	HNGU0604	✓	Fig1	0.23	●	
MFC160050R04A22HN06	50	4	50	56.1	22	40	10.4	6.3	4.3	HNGU0604	✓	Fig1	0.29	●	
MFC160050R05A22HN09	50	5	50	58	22	40	10.4	6.3	7.4	HNGU0905	✓	Fig1	0.26	●	
MFC160063R04A22HN06	63	4	63	69.1	22	40	10.4	6.3	4.3	HNGU0604	✓	Fig1	0.50	●	
MFC160063R06A22HN09	63	6	63	71	22	40	10.4	6.3	7.4	HNGU0905	✓	Fig1	0.46	●	
MFC160080R05A27HN06	80	5	80	86.1	27	50	12.4	7	4.3	HNGU0604	✓	Fig1	1.07	●	
MFC160080R08A27HN09	80	8	80	88	27	50	12.4	7	7.4	HNGU0905	✓	Fig1	1.05	●	
MFC160100R06B32HN06	100	6	100	106.1	32	50	14.5	8	4.3	HNGU0604	✗	Fig2	1.59	●	
MFC160100R10B32HN09	100	10	100	108	32	50	14.5	8	7.4	HNGU0905	✗	Fig2	1.54	●	
MFC160125R08B40HN06	125	8	125	131.1	40	63	16.4	9	4.3	HNGU0604	✗	Fig2	3.02	●	
MFC160125R12B40HN09	125	12	125	133	40	63	16.4	9	7.4	HNGU0905	✗	Fig2	3.02	●	
MFC160160R14C40HN09	160	14	160	168	40	63	16.4	9	7.4	HNGU0905	✗	Fig3	4.40	●	
MFC160200R16C60HN09	200	16	200	208	60	63	25.7	14	7.4	HNGU0905	✗	Fig3	6.00	●	
MFC160250R16C60HN09	250	16	250	258	60	63	25.7	14	7.4	HNGU0905	✗	Fig3	12.38	●	



● Stock ○ Available Upon Order

Dense Pitch

Ordering Code	Dia-meter	Teeth	Dimension(mm)							APMX	Suitable for	Coolant	Shape	Weight (KG)	Stock
			DC	DCX	DCON	LF	KWW	KDP							
MFC160040R05A16HN06	40	5	40	46.1	16	40	8.4	5.6	4.3	HNGU0604	✓	Fig1	0.22	●	
MFC160050R05A22HN06	50	5	50	56.1	22	40	10.4	6.3	4.3	HNGU0604	✓	Fig1	0.29	●	
MFC160063R06A22HN06	63	6	63	69.1	22	40	10.4	6.3	4.3	HNGU0604	✓	Fig1	0.46	●	
MFC160080R08A27HN06	80	8	80	86.1	27	50	12.4	7	4.3	HNGU0604	✓	Fig1	1.03	●	
MFC160100R09B32HN06	100	9	100	106.1	32	50	14.5	8	4.3	HNGU0604	✗	Fig2	1.55	●	
MFC160125R12B40HN06	125	12	125	131.1	40	63	16.4	9	4.3	HNGU0604	✗	Fig2	2.98	●	

● Stock ○ Available Upon Order

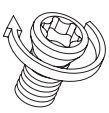
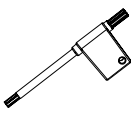
Spare Parts

Part Name		Inserts Screw	Recommended Torque	Insert Screw Wrench	
Inserts	Shape				
	HNGU0604	Ordering Code	SR30M040100K	3.5N·m	TT15PQ
HNGU0905	Ordering Code	SR30M040100K	3.5N·m	TT15PQ	TT15TQ

Recommended Cutting Data





Workpiece	Hardness	Grade	Specification	Ap(mm)			Cutting Speed Vc(m/min)	Feed Rate/Edges fz(mm)					
				MFC115	MFC145	MFC160		Light Cutting(L)	Medium Cutting(M)		Heavy Cutting(H)		
								MFC145	MFC115	MFC145/ MFC160	MFC115	MFC145/ MFC160	
P	Soft Steel	≤ HB180	GPM7120 GA4325	HNGU06	0.6	1	1.6	250 (210-290)	0.1 (0.05-0.15)	0.8 (0.5-1.2)	0.15 (0.1-0.2)	1.2 (0.8-1.5)	0.2 (0.15-0.25)
				HNGU09	0.8	1.6	3		0.15 (0.1-0.2)	1.2 (0.8-1.5)	0.2 (0.15-0.25)	1.5 (1-2)	0.25 (0.2-0.3)
				HNGU13	—	3.2	—		—	—	0.2 (0.15-0.25)	—	0.25 (0.2-0.3)
	Carbon Steel, Alloy Steel	HB180-350	GPM7120 GA4325 GP2115	HNGU06	0.6	1	1.6	220 (180-260)	0.1 (0.05-0.15)	0.8 (0.5-1.2)	0.15 (0.1-0.2)	1.2 (0.8-1.5)	0.2 (0.15-0.25)
				HNGU09	0.8	1.6	3		0.15 (0.1-0.2)	1.2 (0.8-1.5)	0.2 (0.15-0.25)	1.5 (1-2)	0.25 (0.2-0.3)
				HNGU13	—	3.2	—		—	—	0.2 (0.15-0.25)	—	0.25 (0.2-0.3)
	Pre-hardened Steel	HRC35-45	GPM7120 GA4325 GP2115	HNGU06	0.6	1	1.6	140 (100-180)	0.1 (0.05-0.15)	0.6 (0.4-0.8)	0.12 (0.06-0.18)	1 (0.6-1.2)	0.15 (0.1-0.2)
				HNGU09	0.8	1.6	3		0.1 (0.05-0.15)	1 (0.6-1.2)	0.15 (0.1-0.2)	1.2 (0.8-1.5)	0.2 (0.15-0.25)
				HNGU13	—	3.2	—		—	—	0.15 (0.1-0.2)	—	0.2 (0.15-0.25)
M	Stainless (Ferrite, Martensite)	≤ HB270	GM2140 GM4135 GPM7120	HNGU06	0.6	1	1.6	180 (140-220)	0.1 (0.05-0.15)	0.8 (0.5-1.2)	0.15 (0.1-0.2)	1.2 (0.8-1.5)	0.2 (0.15-0.25)
				HNGU09	0.8	1.6	3		0.15 (0.1-0.2)	1.2 (0.8-1.5)	0.2 (0.15-0.25)	1.5 (1-2)	0.25 (0.2-0.3)
				HNGU13	—	3.2	—		—	—	0.2 (0.15-0.25)	—	0.25 (0.2-0.3)
	Stainless (Austenite, Duplex)	≤ HB270	GM2140 GM4135	HNGU06	0.6	1	1.6	140 (100-180)	0.1 (0.05-0.15)	0.6 (0.4-0.8)	0.12 (0.06-0.18)	1 (0.6-1.2)	0.15 (0.1-0.2)
				HNGU09	0.8	1.6	3		0.1 (0.05-0.15)	1 (0.6-1.2)	0.15 (0.1-0.2)	1.2 (0.8-1.5)	0.2 (0.15-0.25)
				HNGU13	—	3.2	—		—	—	0.15 (0.1-0.2)	—	0.2 (0.15-0.25)
K	Grey Cast Iron	≤ HB280	GK2115 GK4125	HNGU06	0.6	1	1.6	180 (140-220)	0.1 (0.05-0.15)	0.8 (0.5-1.2)	0.15 (0.1-0.2)	1.2 (0.8-1.5)	0.2 (0.15-0.25)
				HNGU09	0.8	1.6	3		0.15 (0.1-0.2)	1.2 (0.8-1.5)	0.2 (0.15-0.25)	1.5 (1-2)	0.25 (0.2-0.3)
				HNGU13	—	3.2	—		—	—	0.2 (0.15-0.25)	—	0.25 (0.2-0.3)
	Nodular Cast Iron, Vermicular Graphite Cast Iron	≤ HB350	GK4125 GK2115	HNGU06	0.6	1	1.6	160 (120-200)	0.1 (0.05-0.15)	0.8 (0.5-1.2)	0.15 (0.1-0.2)	1.2 (0.8-1.5)	0.2 (0.15-0.25)
				HNGU09	0.8	1.6	3		0.15 (0.1-0.2)	1.2 (0.8-1.5)	0.2 (0.15-0.25)	1.5 (1-2)	0.25 (0.2-0.3)
				HNGU13	—	3.2	—		—	—	0.2 (0.15-0.25)	—	0.25 (0.2-0.3)
S	Heat-resistant Alloy and Titanium Alloy	HRC30-45	GS4130	HNGU06	0.6	1	1.6	40 (30-60)	0.1 (0.05-0.15)	0.4 (0.3-0.7)	0.12 (0.06-0.18)	—	—
				HNGU09	0.8	1.6	3		0.1 (0.05-0.15)	0.5 (0.3-0.8)	0.15 (0.1-0.2)	—	—
				HNGU13	—	3.2	—		—	—	0.15 (0.1-0.2)	—	—

Face Milling

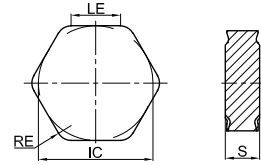
HNE(M)X

Negative Twelve Edge Face Milling Insert











Ordering Code	Dimension(mm)				Coating Grade										Uncoated	Cermet				
	LE	IC	S	RE	GA4225	GA4230	GA4325	GPM7120	GP4225	GP2115	GM4135	GM2140	GK4125	GK2115			GS4130	GH4115	GN9125	GP01TM
	HNEX090510-KF	8.2	16.2	5.56	1.0														<input type="radio"/>	<input type="radio"/>
	HNEX090520-KF	7.0	16.2	5.56	2.0														<input type="radio"/>	<input checked="" type="radio"/>
	HNEX090520-KM	7.2	16.2	5.56	2.0													<input checked="" type="radio"/>	<input checked="" type="radio"/>	
	HNMX090520-KM	7.2	16.2	5.56	2.0													<input checked="" type="radio"/>	<input checked="" type="radio"/>	
	HNEX090516-KR	7.8	16.2	5.56	1.6													<input checked="" type="radio"/>	<input checked="" type="radio"/>	
	HNEX090530-KR	6.2	16.2	5.56	3.0													<input checked="" type="radio"/>	<input checked="" type="radio"/>	
	HNMX090516-KR	7.8	16.2	5.56	1.6													<input checked="" type="radio"/>	<input type="radio"/>	
	★ HNEX090502-WC	6.6	15.875	5.56	0.2													<input type="radio"/>	<input checked="" type="radio"/>	

● Stock ○ Available Upon Order

Note:

★ The HNEX090502-WC insert only corresponds to the MFB160 series cutter body.

HNE(M)X Series Geometry

Light Cutting for Iron Material	Medium Cutting for Iron Material	Heavy Cutting for Iron Material	Wiper
			
KF	KM	KR	WC
			
Light cutting breaker, big rake angle, small arris width, small breaker width.	Medium cutting breaker, sector design, unique arris-width design.	Heavy load cutting breaker, big breaker width and unique rake face design.	Specialized wiped insert, matching adjustable holder could reach high surface quality and stability.

Face Milling

MFB160

Arbor

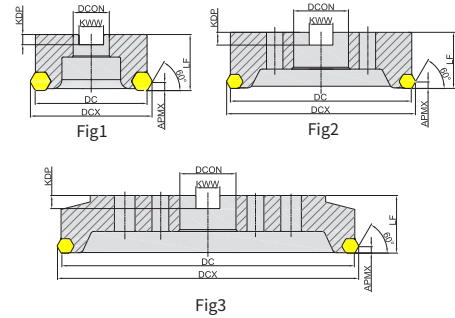
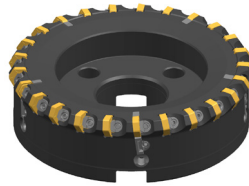

Ordering Code	Dia-meter	Teeth	Dimension(mm)							APMX	Suitable for	Coolant	Shim	Shape	Weight (KG)	Stock
			DC	DCX	DCON	LF	KWW	KDP								
MFB160125R12B40HN09	125	12/3	125	135	40	63	16.4	9	8	HNE(M)X0905	×	✓	Fig1	4.51	●	
MFB160125R15B40HN09	125	15/3	125	135	40	63	16.4	9	8	HNE(M)X0905	×	✓	Fig1	4.39	●	
MFB160160R20C40HN09	160	20/4	160	170	40	63	16.4	9	8	HNE(M)X0905	×	✓	Fig2	6.69	●	
MFB160200R25C60HN09	200	25/5	200	210	60	63	25.7	14	8	HNE(M)X0905	×	✓	Fig2	9.83	●	
MFB160250R30C60HN09	250	30/6	250	260	60	80	25.7	14	8	HNE(M)X0905	×	✓	Fig2	17.43	○	
MFB160315R40D60HN09	315	40/8	315	325	60	80	25.7	14	8	HNE(M)X0905	×	✓	Fig3	24.37	○	

● Stock ○ Available Upon Order

Spare Parts

Part Name		Shim	Shim Screw	Wrench	Inserts Screw	Adjustable Lamp	Insert Screw Wrench	
Inserts	Shape							
	Ordering Code	CWA02B	CWA01B	SDAM060200B	SDAM080245B	AMFB1601RAB	TH30LB	TH40LB

Face Milling

MFB260

Arbor

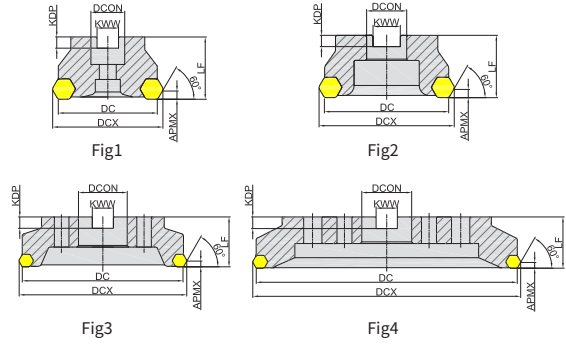

Sparse Pitch

Ordering Code	Dia-meter	Teeth	Dimension(mm)						APMX	Suitable for	Coolant	Shim	Shape	Weight (KG)	Stock
			DC	DCX	DCON	LF	KWW	KDP							
MFB260063R05A22HN09	63	5	63	72	22	40	10.4	6.3	8	HNE(M)X0905	×	×	Fig1	0.62	●
MFB260080R06A27HN09	80	6	80	90	27	50	12.4	7	8	HNE(M)X0905	×	×	Fig1	1.31	●
MFB260100R08B32HN09	100	8	100	110	32	50	14.4	8	8	HNE(M)X0905	×	×	Fig2	1.92	●
MFB260125R12B40HN09	125	12	125	135	40	63	16.4	9	8	HNE(M)X0905	×	×	Fig2	3.60	●
MFB260160R15C40HN09	160	15	160	170	40	63	16.4	9	8	HNE(M)X0905	×	×	Fig3	5.31	●
MFB260200R18C60HN09	200	18	200	210	60	63	25.7	14	8	HNE(M)X0905	×	×	Fig3	7.53	●



● Stock ○ Available Upon Order

Dense Pitch

Ordering Code	Dia-meter	Teeth	Dimension(mm)						APMX	Suitable for	Coolant	Shim	Shape	Weight (KG)	Stock
			DC	DCX	DCON	LF	KWW	KDP							
MFB260080R08A27HN09	80	8	80	90	27	50	12.4	7	8	HNE(M)X0905	×	×	Fig1	1.29	●
MFB260080R10A27HN09	80	10	80	90	27	50	12.4	7	8	HNE(M)X0905	×	×	Fig1	1.26	●
MFB260100R10B32HN09	100	10	100	110	32	50	14.4	8	8	HNE(M)X0905	×	×	Fig2	1.90	●
MFB260100R14B32HN09	100	14	100	110	32	50	14.4	8	8	HNE(M)X0905	×	×	Fig2	1.85	●
MFB260125R15B40HN09	125	15	125	135	40	63	16.4	9	8	HNE(M)X0905	×	×	Fig2	3.55	●
MFB260160R20C40HN09	160	20	160	170	40	63	16.4	9	8	HNE(M)X0905	×	×	Fig3	5.25	●
MFB260200R25C60HN09	200	25	200	210	60	63	25.7	14	8	HNE(M)X0905	×	×	Fig3	7.39	●
MFB260250R30C60HN09	250	30	250	260	60	80	25.7	14	8	HNE(M)X0905	×	×	Fig3	16.31	○
MFB260315R40D60HN09	315	40	315	325	60	80	25.7	14	8	HNE(M)X0905	×	×	Fig4	24.89	○
MFB260315L40D60HN09	315	40	315	325	60	80	25.7	14	8	HNE(M)X0905	×	×	Fig4	24.89	○

● Stock ○ Available Upon Order

Spare Parts

Part Name		Insert Wedge Block	Insert Dowel Screw	Wrench
Inserts	Shape			
	Ordering Code	CWA01B	SDAM060200B	TH30LB
HNE(M)X0905				

Recommended Cutting Data

Workpiece	Hardness	Grade	Specification	Ap (mm)	Cutting Speed Vc(m/min)	Feed Rate/Edges fz(mm)			
						Light Cutting(L)	Medium Cutting(M)	Heavy Cutting(H)	
K	Grey Cast Iron	≤ HB280	GK2115 GK4125	HNE(M)X0905	4	280 (180-400)	0.15 (0.1-0.2)	0.2 (0.1-0.3)	0.3 (0.2-0.4)
	Nodular Cast Iron, Vermicular Graphite Cast Iron	≤ HB350	GK4125 GK2115	HNE(M)X0905	4	230 (160-350)	0.1 (0.05-0.15)	0.15 (0.1-0.2)	0.2 (0.15-0.3)

Face Milling

SBEX

ISO Milling Insert

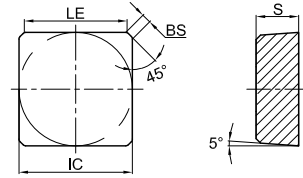



Ordering Code	Dimension(mm)				Uncoated		Coated			Coated
	LE	IC	S	BS	GA0115	GK0115	GA4225	GA4230	GP4225	GP01TM
 SBEX1204ZZ-1	11.18	12.7	4.76	0.8	○					

●Stock ○Available Upon Order

SEEN/SEMN/SEEX

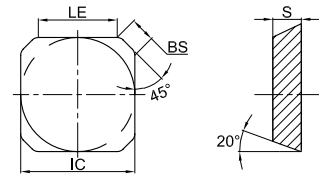
ISO Milling Insert



Ordering Code	Dimension(mm)				Uncoated		Coated			Coated
	LE	IC	S	BS	GA0115	GK0115	GA4225	GA4230	GP4225	GP01TM
 SEEN1203AFTN	8.8	12.7	3.18	2.3		○	○			●
SEEN1204AFTN	8.8	12.7	4.76	2.4		○				
SEEN1504AFTN	10.45	15.875	4.76	2.4			○	●		
SEM1203AFTN	8.8	12.7	4.76	2.4				○		●
SEEN1203AFEN	8.8	12.7	3.18	2.3						●
SEEX1203AFTN	8.8	12.7	3.18	3.0				●		

●Stock ○Available Upon Order

Face Milling

SPEN

ISO Milling Insert

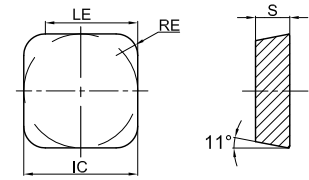

Ordering Code	Dimension(mm)				Uncoated		Coated			Coated
	LE	IC	S	RE	GA0115	GK0115	GA4225	GA4230	GP4225	GP01TM
SPEN150420T	13.87	15.875	4.76	2.0	○					
SPEN150430T	12.87	15.875	4.76	3.0	○					
SPEN190424T	16.65	19.05	4.76	2.4	○					
SPEN250730T	22.4	25.4	7.94	3.0	○					
SPEN190424-WC	15.65	19.05	4.76	2.4	○					
SPEN250730-WC	21.45	25.4	7.94	3.0	○					



● Stock ○ Available Upon Order

Face Milling

SPK(M)N

ISO Milling Insert

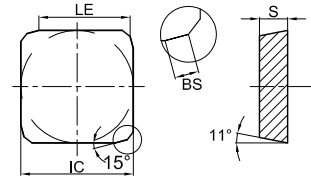

Ordering Code	Dimension(mm)				Uncoated		Coated			Coated
	LE	IC	S	BS	GA0115	GK0115	GA4225	GA4230	GP4225	GP01TM
SPKN1203EDL	10.8	12.7	3.18	1.4	○	○	○	○		
SPKN1203EDR	10.8	12.7	3.18	1.4	○	○		●		
SPKN1203EDTL	10.8	12.7	3.18	1.4				○		
SPKN1203EDTR	10.8	12.7	3.18	1.4				●		
SPKN1504EDL	13.5	15.875	4.76	1.4		●				
SPKN1504EDR	13.5	15.875	4.76	1.4	●	●				
SPKN1504EDTL	13.5	15.875	4.76	1.4		○		○		
SPKN1504EDTR	13.5	15.875	4.76	1.4		○		●		
SPKN1905EDL	15.1	19.05	5.56	2.7				○		
SPKN1905EDR	15.1	19.05	5.56	2.7				○		
SPKN1905EDTL	15.1	19.05	5.56	2.7				○		
SPKN1905EDTR	15.1	19.05	5.56	2.7				○		
SPMN1504EDL	13.5	15.875	4.76	1.4		○				
SPMN1504EDR	13.5	15.875	4.76	1.4		●				
SPMN1504EDTR	13.5	15.875	4.76	1.4					○	

●Stock ○Available Upon Order



Face Milling

SPEN-W

ISO Milling Insert

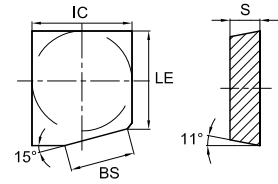



Ordering Code	Dimension(mm)				Uncoated		Coated			Coated
	LE	IC	S	BS	GA0115	GK0115	GA4225	GA4230	GP4225	GP01TM
	SPEN1504EDL-W	15.5	15.875	4.76	10.2		<input type="radio"/>			
	SPEN1504EDR-W	15.5	15.875	4.76	10.2		<input type="radio"/>			

● Stock ○ Available Upon Order

SPER

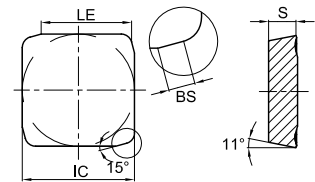
ISO Milling Insert



Ordering Code	Dimension(mm)				Uncoated		Coated			Coated
	LE	IC	S	BS	GA0115	GK0115	GA4225	GA4230	GP4225	GP01TM
	SPER1203EDTL-MR	10.2	12.7	3.18	1.3			<input type="radio"/>		
	SPER1203EDTR-MR	10.2	12.7	3.18	1.3			<input type="radio"/>		

● Stock ○ Available Upon Order

Face Milling

SPNR

ISO Milling Insert

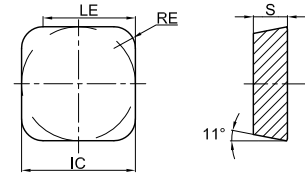



Ordering Code	Dimension(mm)				Uncoated		Coated			Coated
	LE	IC	S	RE	GA0115	GK0115	GA4225	GA4230	GP4225	GP01TM
SPNR150424T	13.475	15.875	4.76	2.4		○				
										

●Stock ○Available Upon Order

SPCW

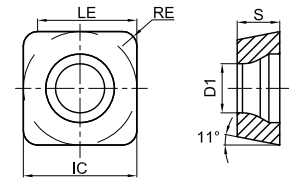
ISO Milling Insert



Ordering Code	Dimension(mm)					Uncoated		Coated			Coated
	LE	IC	S	D1	RE	GA0115	GK0115	GA4225	GA4230	GP4225	GP01TM
SPCW120412	11.5	12.7	4.76	5.5	1.2		○		○		
SPCW120416	11.1	12.7	4.76	5.5	1.6		○				
SPCW150516	14.275	15.875	5.56	5.5	1.6				○		
											



●Stock ○Available Upon Order

Face Milling

TPER/TPKR/TPKN

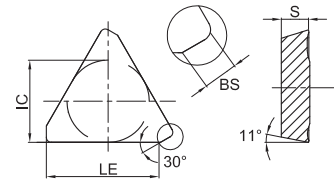
ISO Milling Insert





Ordering Code	Dimension(mm)				Uncoated		Coated			Coated
	LE	IC	S	BS	GA0115	GK0115	GA4225	GA4230	GP4225	GP01TM
 TPER1603PDTL-MR TPER1603PDTR-MR	13.2	9.525	3.18	1.3				○		
	13.2	9.525	3.18	1.3				○		
 TPKR1603PPTR	13.6	9.525	3.18	1.3			●			
 TPKN1603PDL TPKN1603PDR TPKN1603PDTL TPKN1603PDTR TPKN2204PDL TPKN2204PDR TPKN2204PDTL TPKN2204PDTR	13.4	9.525	3.18	1.3		●				
	13.4	9.525	3.18	1.3	○	●		●		
	13.4	9.525	3.18	1.3				○		
	13.4	9.525	3.18	1.3				●		
	18.66	12.7	4.76	1.4				○		
	18.66	12.7	4.76	1.4	●			●		
	18.66	12.7	4.76	1.4				○		
	18.66	12.7	4.76	1.4	○	○	○	●		

● Stock ○ Available Upon Order

TPNR

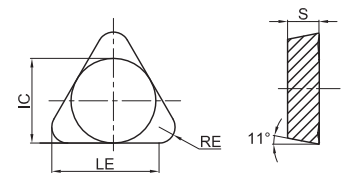
ISO Milling Insert



Ordering Code	Dimension(mm)				Uncoated		Coated			Coated
	LE	IC	S	RE	GA0115	GK0115	GA4225	GA4230	GP4225	GP01TM
 TPNR220424T	16.08	12.7	4.76	2.4				○		





● Stock ○ Available Upon Order

Shoulder Milling

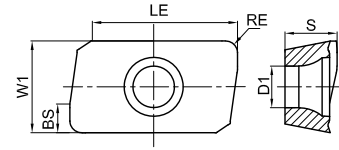
APM(G)T











Positive Two Edge Shoulder Milling Insert



Ordering Code	Dimension(mm)						Coating Grade										Uncoated	Cermnet			
	LE	W1	S	BS	D1	RE	GA4225	GA4230	GA4325	GPM7120	GP4225	GP2115	GM4135	GM2140	GK4125	GK2115			GS4130	GH4115	GN9125
	APMT1135PDER-PL	9.7	6.16	3.5	1.92	2.8	0.8	●	●	●	●		●				●				
	APMT1604PDER-PL	14.9	9.26	4.76	2	4.6	0.8	●	●	●								●			
	APMT1135PDER-PM	9.7	6.16	3.5	1.92	2.8	0.8	●	●	●	●		●	●	●	●	●				●
	APMT113504R-PM	9.7	6.16	3.5	1.92	2.8	0.4		●	○											●
	APMT1604PDER-PM	14.9	9.26	4.76	2	4.6	0.8	●	●	●	●		●	●	●	●	●				●
	APMT160416R-PM	14.9	9.26	4.76	2	4.6	1.6		●	○											
	APMT113508-GM	9.7	6.16	3.5	1.92	2.8	0.8			○											
	APMT160410-GM	14.9	9.26	4.76	2	4.6	1.0			○		●	●								
	APMT1135PDER-PR	9.7	6.16	3.5	1.87	2.8	0.8	●	●	●	●		●	●		●					
	APMT1604PDER-PR	14.9	9.26	4.76	2.2	4.6	0.8	●	●	●	●		●	●	●	●					
	APGT1135PDFR-AL	9.7	6.16	3.5	1.92	2.8	0.8														●
	APGT1604PDFR-AL	14.9	9.26	4.76	2.2	4.6	0.8														●

● Stock ○ Available Upon Order

APM(G)T Series Geometry

Light Cutting for General Material	Medium Cutting for General Material	Medium Cutting for General Material	Steel Workpiece Heavy Cutting	Aluminum Cutting
				
PL	PM	GM	PR	AL
				
Under normal working conditions, Achieve high stability machining.	Light load cutting with low cutting resistance, Get better processing quality.	Under normal working conditions, Achieve high stability machining.	Suitable on roughing, good edge strength.	Suitable on Al processing, sharp edge with polishing.

Shoulder Milling

MEA190

Arbor

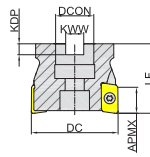
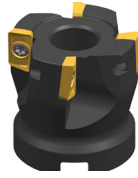

Fig1

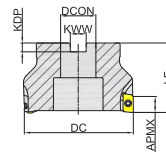

Fig2

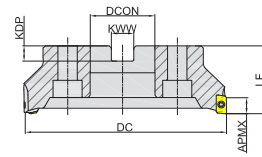

Fig3

Ordering Code	Dia- meter	Teeth	Dimension(mm)					APMX	Suitable for	Coolant	Shape	Weight (KG)	Stock
			DC	DCON	LF	KWW	KDP						
MEA190040R05A16AP11	40	5	40	16	40	8.4	5.6	9	APM(G)T1135	×	Fig1	0.20	●
MEA190050R04A22AP16	50	4	50	22	40	10.4	6.3	14	APM(G)T1604	×	Fig1	0.33	●
MEA190050R06A22AP11	50	6	50	22	40	10.4	6.3	9	APM(G)T1135	×	Fig1	0.37	●
MEA190063R05A22AP16	63	5	63	22	50	10.4	6.3	14	APM(G)T1604	×	Fig1	0.61	●
MEA190080R06A27AP16	80	6	80	27	50	12.4	7	14	APM(G)T1604	×	Fig1	0.96	●
MEA190100R07B32AP16	100	7	100	32	63	14.4	8	14	APM(G)T1604	×	Fig2	2.13	●
MEA190125R08B40AP16	125	8	125	40	63	16.4	9	14	APM(G)T1604	×	Fig2	2.80	●
MEA190160R10C40AP16	160	10	160	40	63	16.4	9	14	APM(G)T1604	×	Fig3	3.94	●
MEA190200R12C60AP16	200	12	200	60	63	25.7	14	14	APM(G)T1604	×	Fig3	7.25	●
MEA190250R14C60AP16	250	14	250	60	63	25.7	14	14	APM(G)T1604	×	Fig3	10.66	○

● Stock ○ Available Upon Order

Shoulder Milling

MEA190

Cylindrical Straight Type

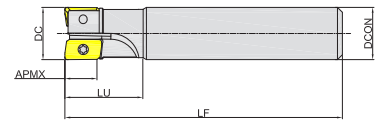

Fig4

Ordering Code	Dia-meter	Teeth	Dimension(mm)				APMX	Suitable for	Coolant	Shape	Weight (KG)	Stock
			DC	DCON	LF	LU						
MEA190016R02P16AP11	16	2	16	16	120	40	9	APM(G)T1135	×	Fig4	0.17	●
MEA190016R02P16AP11L	16	2	16	16	170	50	9	APM(G)T1135	×	Fig4	0.24	●
MEA190020R02P20AP11	20	2	20	20	160	50	9	APM(G)T1135	×	Fig4	0.36	●
MEA190020R03P20AP11	20	3	20	20	160	50	9	APM(G)T1135	×	Fig4	0.36	●
MEA190025R02P25AP16	25	2	25	25	160	50	14	APM(G)T1604	×	Fig4	0.55	●
MEA190025R03P25AP11	25	3	25	25	160	50	9	APM(G)T1135	×	Fig4	0.57	●
MEA190025R04P25AP11	25	4	25	25	160	50	9	APM(G)T1135	×	Fig4	0.56	●
MEA190032R03P32AP16	32	3	32	32	160	50	14	APM(G)T1604	×	Fig4	0.90	●
MEA190032R04P32AP11	32	4	32	32	160	80	9	APM(G)T1135	×	Fig4	0.91	●

● Stock ○ Available Upon Order







Spare Parts

Part Name		Inserts Screw	Recommended Torque	Insert Screw Wrench	
Inserts	Shape				
	Ordering Code	SI60M025065-03509S	1.0N·m	TT07PQ	—
	Ordering Code	SI60M040089-05313S	3.5N·m	TT15PQ	TT15TQ

Recommended Cutting Data

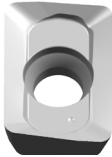
	Workpiece	Hardness	Grade	Specification	Ap (mm)	Cutting Speed Vc(m/min)	Feed Rate/Edges fz(mm)		
							Light Cutting(L)	Medium Cutting(M)	Heavy Cutting(H)
P	Soft Steel	≤ HB180	GA4325	APMT1135	2.7	250 (210-290)	0.1 (0.05-0.15)	0.15 (0.1-0.2)	0.20 (0.1-0.25)
				APMT1604	4.2		0.2 (0.1-0.3)	0.25 (0.15-0.35)	0.3 (0.2-0.4)
	Carbon Steel, Alloy Steel	HB180-350	GA4325 GP2115	APMT1135	2.7	220 (180-260)	0.1 (0.05-0.15)	0.15 (0.1-0.2)	0.2 (0.1-0.25)
				APMT1604	4.2		0.2 (0.1-0.3)	0.25 (0.15-0.35)	0.3 (0.2-0.4)
	Pre-harden Steel	HRC35-45	GA4325 GP2115	APMT1135	2.7	140 (100-180)	0.08 (0.05-0.15)	0.1 (0.05-0.15)	0.15 (0.1-0.2)
				APMT1604	4.2		0.1 (0.05-0.15)	0.15 (0.1-0.2)	0.2 (0.1-0.25)
M	Stainless (Ferrite, Martensite)	≤ HB270	GM2140 GM4135 GA4230	APMT1135	2.7	180 (140-220)	0.12 (0.1-0.2)	0.15 (0.1-0.2)	0.2 (0.1-0.3)
				APMT1604	4.2		0.15 (0.1-0.2)	0.25 (0.15-0.35)	0.3 (0.2-0.4)
	Stainless (Austenite, Diphasic)	≤ HB270	GM2140 GM4135	APMT1135	2.7	140 (100-180)	0.1 (0.05-0.15)	0.12 (0.1-0.2)	0.15 (0.1-0.2)
				APMT1604	4.2		0.12 (0.1-0.2)	0.15 (0.1-0.2)	0.2 (0.1-0.3)
K	Grey Cast Iron	≤ HB280	GK2115 GK4125	APMT1135	2.7	180 (140-220)	0.1 (0.05-0.15)	0.15 (0.1-0.2)	0.2 (0.1-0.25)
				APMT1604	4.2		0.2 (0.1-0.3)	0.25 (0.1-0.4)	0.3 (0.2-0.5)
	Nodular Cast Iron, Vermicular Graphite Cast Iron	≤ HB350	GK4125 GK2115	APMT1135	2.7	160 (120-200)	0.08 (0.05-0.15)	0.1 (0.05-0.15)	0.15 (0.1-0.2)
				APMT1604	4.2		0.1 (0.05-0.15)	0.15 (0.1-0.2)	0.2 (0.1-0.25)
N	Nonferrous Metal	HB60-210	GN9125	APGT1135	2.7	≥ 300	0.08 (0.05-0.15)	0.1 (0.05-0.15)	0.15 (0.1-0.2)
				APGT1604	4.2		0.1 (0.05-0.15)	0.15 (0.1-0.2)	0.2 (0.1-0.25)
S	Heat-resistant Alloy and Titanium Alloy	HRC30-45	GS4130	APMT1135	2.7	40 (30-60)	0.08 (0.05-0.15)	0.08 (0.05-0.15)	0.1 (0.05-0.15)
				APMT1604	4.2		0.1 (0.05-0.15)	0.1 (0.05-0.15)	0.15 (0.1-0.2)

APK(E)T Series Geometry

Light Cutting for General Material	Medium Cutting for General Material	Heavy Cutting for General Material	Aluminum Cutting
			
GL	GM	GH	NL
			
Light cutting of low cutting force, good processing quality.	High stability in most cases.	Suitable on roughing, good edge strength.	Suitable on Al processing, sharp edge with polishing.

Shoulder Milling

MEB190

Arbor

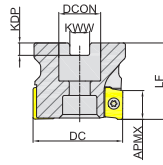

Fig1

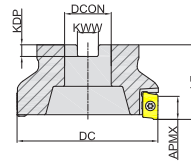

Fig2

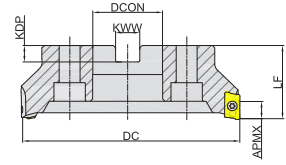

Fig3

Ordering Code	Dia-meter	Teeth	Dimension(mm)					APMX	Suitable for	Coolant	Shape	Weight (KG)	Stock
			DC	DCON	LF	KWW	KDP						
MEB190040R05A16AP11	40	5	40	16	40	8.4	5.6	9	APK(E)T1135	✓	Fig1	0.21	●
MEB190050R04A22AP16	50	4	50	22	40	10.4	6.3	14	APK(E)T1604	✓	Fig1	0.30	●
MEB190050R07A22AP11	50	7	50	22	40	10.4	6.3	9	APK(E)T1135	✓	Fig1	0.29	●
MEB190063R05A22AP16	63	5	63	22	40	10.4	6.3	14	APK(E)T1604	✓	Fig1	0.41	●
MEB190063R07A22AP11	63	7	63	22	40	10.4	6.3	9	APK(E)T1135	×	Fig1	0.48	●
MEB190080R07A27AP16	80	7	80	27	50	12.4	7	14	APK(E)T1604	✓	Fig1	1.00	●
MEB190080R08A27AP11	80	8	80	27	50	12.4	7	9	APK(E)T1135	✓	Fig1	1.02	●
MEB190100R08A32AP16	100	8	100	32	50	14.4	8	14	APK(E)T1604	✓	Fig1	1.70	●
MEB190100R12B32AP11	100	12	100	32	63	14.4	8	9	APK(E)T1135	✓	Fig2	1.60	●
MEB190125R06B40AP16	125	6	125	40	63	16.4	9	14	APK(E)T1604	×	Fig2	2.79	●
MEB190125R09B40AP16	125	9	125	40	63	16.4	9	14	APK(E)T1604	×	Fig2	2.76	●
MEB190125R11B40AP11	125	11	125	40	63	16.4	9	9	APK(E)T1135	×	Fig2	2.47	●
MEB190160R10C40AP16	160	10	160	40	63	16.4	9	14	APK(E)T1604	×	Fig3	4.05	●
MEB190200R12C60AP16	200	12	200	60	63	25.7	13	14	APK(E)T1604	×	Fig3	5.97	●

● Stock ○ Available Upon Order

Shoulder Milling

MEB190

Side Clamp Type

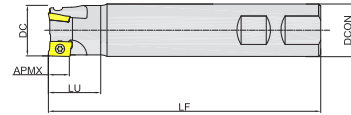

Fig4

Ordering Code	Dia- meter	Teeth	Dimension(mm)				APMX	Suitable for	Coolant	Shape	Weight (KG)	Stock
			DC	DCON	LF	LU						
MEB190016R02W16AP11	16	2	16	16	130	25	9	APKT1135	×	Fig4	0.18	●
MEB190016R02W16AP11L	16	2	16	16	200	50	9	APKT1135	×	Fig4	0.28	●
MEB190020R02W20AP11	20	2	20	20	130	25	9	APK(E)T1135	✓	Fig4	0.27	●
MEB190020R03W20AP11	20	3	20	20	130	25	9	APK(E)T1135	✓	Fig4	0.26	●
MEB190020R03W20AP11L	20	3	20	20	200	85	9	APK(E)T1135	✓	Fig4	0.41	●
MEB190025R02W25AP16	25	2	25	25	130	45	14	APK(E)T1604	✓	Fig4	0.41	●
MEB190025R02W25AP16L	25	2	25	25	200	83	14	APK(E)T1604	✓	Fig4	0.65	●
MEB190025R03W25AP11	25	3	25	25	130	28	9	APK(E)T1135	✓	Fig4	0.43	●
MEB190025R03W25AP11L	25	3	25	25	200	89	9	APK(E)T1135	✓	Fig4	0.65	●
MEB190025R04W25AP11	25	4	25	25	130	28	9	APK(E)T1135	✓	Fig4	0.43	●
MEB190032R03W32AP16	32	3	32	32	130	40	14	APK(E)T1604	✓	Fig4	0.68	●
MEB190032R03W32AP16L	32	3	32	32	200	54	14	APK(E)T1604	✓	Fig4	1.12	●
MEB190032R04W32AP11	32	4	32	32	130	30	9	APK(E)T1135	✓	Fig4	0.72	●
MEB190032R04W32AP11L	32	4	32	32	200	80	9	APK(E)T1135	✓	Fig4	1.13	●
MEB190040R03W32AP16	40	3	40	32	150	45	14	APK(E)T1604	✓	Fig4	0.89	●

● Stock ○ Available Upon Order

MEB190

Replaceable Tool Head

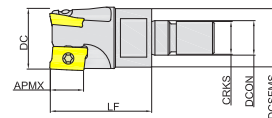

Fig5

Ordering Code	Dia- meter	Teeth	Dimension(mm)					APMX	Suitable for	Coolant	Shape	Weight (KG)	Stock
			DC	DCSFMS	DCON	LF	CRKS						
MEB190016R02M08AP11	16	2	16	14.5	8.5	26	M8	9	APK(E)T1135	×	Fig5	0.03	●
MEB190020R03M10AP11	20	3	20	17.8	10.5	31	M10	9	APK(E)T1135	✓	Fig5	0.05	●
MEB190025R02M12AP16	25	2	25	23	17	35	M12	14	APK(E)T1604	✓	Fig5	0.08	●
MEB190025R03M12AP11	25	3	25	23	12.5	35	M12	9	APK(E)T1135	✓	Fig5	0.10	●
MEB190025R04M12AP11	25	4	25	23	12.5	35	M12	9	APK(E)T1135	✓	Fig5	0.10	●
MEB190032R03M16AP16	32	3	32	28.5	17	43	M16	14	APK(E)T1604	✓	Fig5	0.18	●
MEB190032R04M16AP11	32	4	32	28.5	17	43	M16	9	APK(E)T1135	✓	Fig5	0.21	●
MEB190032R05M16AP11	32	5	32	28.5	17	43	M16	9	APK(E)T1135	✓	Fig5	0.21	●
MEB190035R05M16AP11	35	5	35	28.5	17	43	M16	9	APK(E)T1135	✓	Fig5	0.22	●

● Stock ○ Available Upon Order

Shoulder Milling

MHB190

Corn Milling Cutter Body MHB190-Arbor

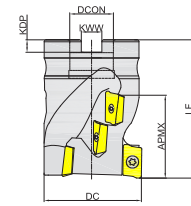
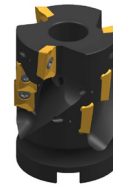

Fig6

Ordering Code	Dia-meter	Teeth	Dimension(mm)					APMX	Suitable for	Coolant	Shape	Weight (KG)	Stock
			DC	DCON	LF	KWW	KDP						
MHB190050R03A22AP16	50	3/9	50	22	70	10.4	6.3	43	APKT1604	✓	Fig6	0.59	●
MHB190050R04A22AP11	50	4/16	50	22	70	10.4	6.3	39.9	APKT1135	×	Fig6	0.70	●
MHB190063R04A27AP16	63	4/16	63	27	85	12.4	6.3	57	APKT1604	✓	Fig6	1.28	●
MHB190063R05A27AP11	63	5/20	63	27	70	12.4	6.3	39.9	APKT1135	✓	Fig6	1.16	●
MHB190080R05A32AP16	80	5/20	80	32	85	14.4	7	57	APKT1604	✓	Fig6	2.21	●

● Stock ○ Available Upon Order

MHB190

Corn Milling Cutter Body MHB190-Side Clamp Type

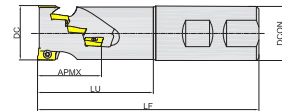

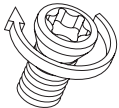
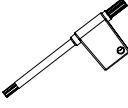
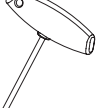

Fig7

Ordering Code	Dia-meter	Teeth	Dimension(mm)				APMX	Suitable for	Coolant	Shape	Weight (KG)	Stock
			DC	DCON	LF	LU						
MHB190032R02W32AP11	32	2/8	32	32	130	65	39.9	APKT1135	✓	Fig7	0.68	●
MHB190040R03W32AP11	40	3/12	40	32	130	66	39.9	APKT1135	✓	Fig7	0.84	●

● Stock ○ Available Upon Order

Spare Parts

Part Name		Inserts Screw	Recommended Torque	Insert Screw Wrench	
Inserts	Shape				
	Ordering Code	SI60M030072-04210S	1.8N·m	TT09PQ	TT09TQ
	Ordering Code	SI60M035080-05314S	3.0N·m	TT15PQ	TT15TQ

Recommended Cutting Data



	Workpiece	Hardness	Grade	Specification	Ap (mm)	Cutting Speed Vc(m/min)	Feed Rate/Edges fz(mm)		
							Light Cutting(L)	Medium Cutting(M)	Heavy Cutting(H)
P	Soft Steel	≤ HB180	GA4225 GA4230	APKT1135	2.7	180 (140-220)	0.1 (0.05-0.15)	0.15 (0.1-0.2)	0.2 (0.1-0.25)
				APKT1604	4.2		0.2 (0.1-0.3)	0.25 (0.15-0.35)	0.3 (0.2-0.4)
	Carbon Steel, Alloy Steel	HB180-350	GA4225 GA4230 GP2115	APKT1135	2.7	150 (110-190)	0.1 (0.05-0.15)	0.15 (0.1-0.2)	0.2 (0.1-0.25)
				APKT1604	4.2		0.2 (0.1-0.3)	0.25 (0.15-0.35)	0.3 (0.2-0.4)
	Pre-harden Steel	HRC35-45	GA4230 GA4225 GP2115	APKT1135	2.7	130 (90-170)	0.08 (0.05-0.15)	0.1 (0.05-0.15)	0.15 (0.1-0.2)
				APKT1604	4.2		0.1 (0.05-0.15)	0.15 (0.1-0.2)	0.2 (0.1-0.25)
M	Stainless (Ferrite, Martensite)	≤ HB270	GM2140 GM4135 GA4230	APKT1135	2.7	160 (120-200)	0.12 (0.1-0.2)	0.15 (0.1-0.2)	0.2 (0.1-0.3)
				APKT1604	4.2		0.15 (0.1-0.2)	0.25 (0.15-0.35)	0.3 (0.2-0.4)
	Stainless (Austenite, Diphasic)	≤ HB270	GM2140 GM4135	APKT1135	2.7	160 (120-200)	0.1 (0.05-0.15)	0.12 (0.1-0.2)	0.15 (0.1-0.2)
				APKT1604	4.2		0.12 (0.1-0.2)	0.15 (0.1-0.2)	0.2 (0.1-0.3)
K	Grey Cast Iron	≤ HB280	GK2115 GK4125	APKT1135	2.7	180 (150-220)	0.1 (0.05-0.15)	0.15 (0.1-0.2)	0.2 (0.1-0.25)
				APKT1604	4.2		0.2 (0.1-0.3)	0.25 (0.1-0.4)	0.3 (0.2-0.5)
	Nodular Cast Iron, Vermicular Graphite Cast Iron	≤ HB350	GK4125 GK2115	APKT1135	2.7	120 (100-180)	0.1 (0.05-0.15)	0.1 (0.05-0.15)	0.15 (0.1-0.2)
				APKT1604	4.2		0.2 (0.1-0.3)	0.15 (0.1-0.2)	0.2 (0.1-0.25)
N	Nonferrous Metal	HB60-210	GN9125	APET1135	2.7	500 (200-900)	0.08 (0.05-0.15)	0.1 (0.05-0.15)	0.15 (0.1-0.2)
				APET1604	4.2		0.1 (0.05-0.15)	0.15 (0.1-0.2)	0.2 (0.1-0.25)
S	Heat- resistant Alloy and Titanium Alloy	HRC30-45	GS4130	APKT1135	2.7	60 (50-100)	0.08 (0.05-0.15)	0.08 (0.05-0.15)	0.1 (0.05-0.15)
				APKT1604	4.2		0.1 (0.05-0.15)	0.1 (0.05-0.15)	0.15 (0.1-0.2)

Shoulder Milling

ANKX

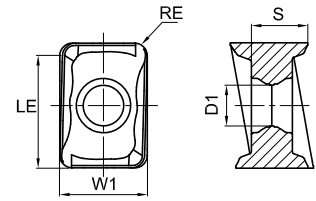





Curved Edge Shoulder Milling Insert



Ordering Code	Dimension(mm)					Coating Grade										Uncoated	Cermet			
	LE	W1	S	D1	RE	GA4225	GA4230	GA4325	GPM7120	GP4225	GP2115	GM4135	GM2140	GK4125	GK2115			GS4130	GH4115	GN9125
	ANKX120704R-GL	11.6	10	8	4.3	0.4	●	●			●	○	○	○		○				
	ANKX160708R-GL	15.2	11.2	7.9	5.2	0.8	○	○		●	●	○	○	○	○	○				
	ANKX120708R-GM	11.2	10	8	4.3	0.8	●	●		●	○		○	●	○	○				
	ANKX160708R-GM	15.2	11.2	7.9	5.2	0.8	●	●		●	●		●	●	●	●				
	ANKX160716R-GM	14.4	11.2	7.9	5.2	1.6	●	●			○		○	○	●	○				
	ANKX160716R-GH	14.4	11.2	7.9	5.2	1.6				○				●						

● Stock ○ Available Upon Order

ANKX Series Geometry

Light Cutting for General Material	Medium Cutting for General Material	Heavy Cutting for General Material
		
GL	GM	GH
		
Light cutting of low cutting force, good processing quality.	High stability in most cases.	Suitable on roughing, good edge strength.

Shoulder Milling

MEC190

Arbor

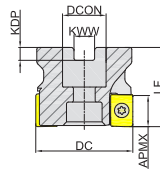

Fig1

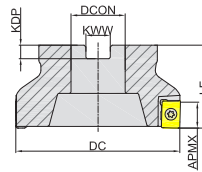

Fig2

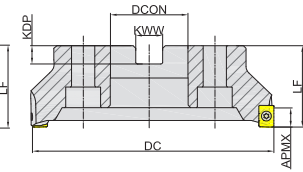

Fig3

Ordering Code	Dia-meter	Teeth	Dimension(mm)					APMX	Suitable for	Coolant	Shape	Weight (KG)	Stock
			DC	DCON	LF	KWW	KDP						
MEC190050R04A22AN12	50	4	50	22	40	10.4	6.3	9	ANKX1207	✓	Fig1	0.30	●
MEC190050R04A22AN16	50	4	50	22	40	10.4	6.3	14	ANKX1607	✓	Fig1	0.31	●
MEC190063R05A22AN12	63	5	63	22	40	10.4	6.3	9	ANKX1207	✓	Fig1	0.49	●
MEC190063R05A22AN16	63	5	63	22	40	10.4	6.3	14	ANKX1607	✓	Fig1	0.47	●
MEC190080R05A27AN16	80	5	80	27	50	12.4	7	14	ANKX1607	✓	Fig1	0.88	●
MEC190080R06A27AN16	80	6	80	27	50	12.4	7	14	ANKX1607	✓	Fig1	0.88	●
MEC190100R07B32AN16	100	7	100	32	50	14.4	8	14	ANKX1607	✓	Fig2	1.34	●
MEC190100R08B32AN16	100	8	100	32	50	14.4	8	14	ANKX1607	✓	Fig2	1.31	●
MEC190125R10B40AN16	125	10	125	40	63	16.4	9	14	ANKX1607	✓	Fig2	2.83	●
MEC190160R12C40AN16	160	12	160	40	63	16.4	9	14	ANKX1607	✗	Fig3	4.03	●
MEC190200R14C60AN16	200	14	200	60	63	25.7	14	14	ANKX1607	✗	Fig3	5.98	●

● Stock ○ Available Upon Order

MEC190

Side Clamp Type

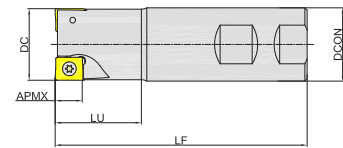
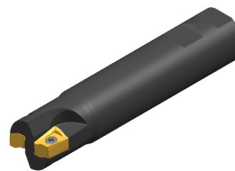

Fig4

Ordering Code	Dia-meter	Teeth	Dimension(mm)				APMX	Suitable for	Coolant	Shape	Weight (KG)	Stock
			DC	DCON	LF	LU						
MEC190032R02W32AN12	32	2	32	32	110	40	9	ANKX1207	✗	Fig4	0.62	●
MEC190032R02W32AN16	32	2	32	32	150	40	14	ANKX1607	✗	Fig4	0.85	●
MEC190032R02W32AN16L	32	2	32	32	200	54	14	ANKX1607	✗	Fig4	1.15	●
MEC190032R03W32AN16	32	3	32	32	150	40	14	ANKX1607	✗	Fig4	0.83	●
MEC190032R03W32AN16L	32	3	32	32	200	56	14	ANKX1607	✗	Fig4	1.15	●
MEC190040R03W32AN12	40	3	43	32	130	40	9	ANKX1207	✓	Fig4	0.80	●
MEC190040R03W32AN16	40	3	40	32	150	47	14	ANKX1607	✓	Fig4	0.89	●

● Stock ○ Available Upon Order

Shoulder Milling

MHC190

Corn Milling Cutter Body MHC190-Arbor

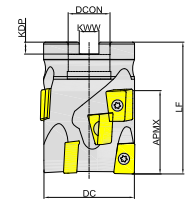
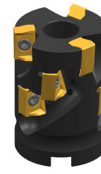

Fig5

Ordering Code	Dia- meter	Teeth	Dimension(mm)					APMX	Suitable for	Coolant	Shape	Weight (KG)	Stock
			DC	DCON	LF	KWW	KDP						
MHC190050R03A22AN12	50	3/12	50	22	70	10.4	6.3	43	ANKX1207	✓	Fig5	0.58	●
MHC190050R03A22AN16	50	3/9	50	22	70	10.4	6.3	43	ANKX1607	✓	Fig5	0.57	●
MHC190063R04A27AN12	63	4/16	63	27	70	12.4	6.3	43	ANKX1207	✓	Fig5	0.96	●
MHC190063R04A27AN16	63	4/16	63	27	85	12.4	6.3	57	ANKX1607	✓	Fig5	1.21	●
MHC190080R05A32AN16	80	5/20	80	32	85	14.4	7	57	ANKX1607	✓	Fig5	2.15	●

● Stock ○ Available Upon Order

MHC190

Corn Milling Cutter Body MHC190-Side Clamp Type

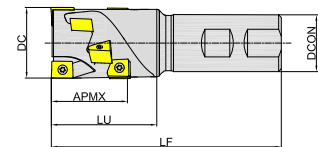
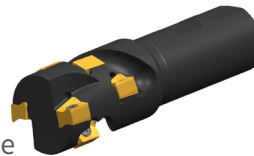

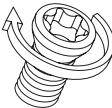
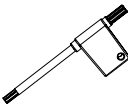
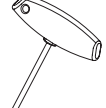

Fig6

Ordering Code	Dia- meter	Teeth	Dimension(mm)				APMX	Suitable for	Coolant	Shape	Weight (KG)	Stock
			DC	DCON	LF	LU						
MHC190040R02W32AN12	40	2/8	40	32	130	66	43	ANKX1207	✓	Fig6	0.75	●

● Stock ○ Available Upon Order

Spare Parts

Part Name		Inserts Screw	Recommended Torque	Insert Screw Wrench	
Inserts	Shape				
	Ordering Code	SI60M035120-05314S	3.0N·m	TT15PQ	—
ANX1207	Ordering Code	SI60M045120-06412S	4.5N·m	TT20PQ	TT20TQ

Recommended Cutting Data

Workpiece	Hardness	Grade	Specification	Ap (mm)	Cutting Speed Vc(m/min)	Feed Rate/Edges fz(mm)			
						Light Cutting(L)	Medium Cutting(M)	Heavy Cutting(H)	
P	Soft Steel	≤ HB180	GA4225 GA4230	ANX1207	2.7	180 (140-220)	0.1 (0.05-0.15)	0.15 (0.1-0.2)	0.2 (0.1-0.25)
				ANX1607			4.2	0.15 (0.1-0.2)	0.25 (0.15-0.35)
	Carbon Steel, Alloy Steel	HB180-350	GA4225 GA4230 GP2115	ANX1207	2.7	150 (110-190)	0.1 (0.05-0.15)	0.15 (0.1-0.2)	0.2 (0.1-0.25)
				ANX1607			4.2	0.15 (0.1-0.2)	0.25 (0.15-0.35)
	Pre-harden Steel	HRC35-45	GA4230 GA4225 GP2115	ANX1207	2.7	150 (110-190)	0.08 (0.05-0.15)	0.1 (0.05-0.15)	0.15 (0.1-0.2)
				ANX1607			4.2	0.1 (0.05-0.15)	0.15 (0.1-0.2)
M	Stainless (Ferrite, Martensite)	≤ HB270	GM2140 GM4135 GA4230	ANX1207	2.7	140 (100-180)	0.12 (0.1-0.2)	0.15 (0.1-0.2)	0.2 (0.1-0.3)
				ANX1607			4.2	0.15 (0.1-0.2)	0.25 (0.15-0.35)
	Stainless (Austenite, Duphasic)	≤ HB270	GM2140 GM4135	ANX1207	2.7	120 (80-160)	0.1 (0.05-0.15)	0.12 (0.1-0.2)	0.15 (0.1-0.2)
				ANX1607			4.2	0.12 (0.1-0.2)	0.15 (0.1-0.2)
K	Grey Cast Iron	≤ HB280	GK2115 GK4125	ANX1207	2.7	180 (150-220)	0.1 (0.05-0.15)	0.15 (0.1-0.2)	0.2 (0.1-0.25)
				ANX1607			4.2	0.15 (0.1-0.2)	0.25 (0.1-0.4)
	Nodular Cast Iron, Vermicular Graphite Cast Iron	≤ HB350	GK4125 GK2115	ANX1207	2.7	120 (100-180)	0.1 (0.05-0.15)	0.1 (0.05-0.15)	0.2 (0.1-0.25)
				ANX1607			4.2	0.15 (0.1-0.2)	0.25 (0.15-0.35)
S	Heat-resistant Alloy and Titanium Alloy	HRC30-45	GS4130	ANX1207	2.7	60 (50-100)	0.08 (0.05-0.15)	0.08 (0.05-0.15)	0.1 (0.05-0.15)
				ANX1607			4.2	0.1 (0.05-0.15)	0.1 (0.05-0.15)

Shoulder Milling

WNGU



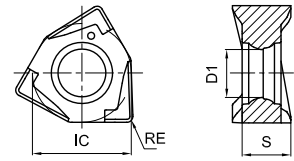

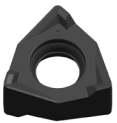
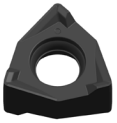
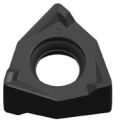
Double Face Six Edge Shoulder Milling

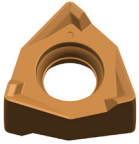
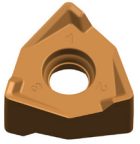
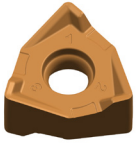

Ordering Code	Dimension(mm)				Coating Grade										Uncoated	Cermat			
	IC	D1	S	RE	GA4225	GA4230	GA4325	GPM7120	GP4225	GP2115	GM4135	GM2140	GK4125	GK2115			GS4130	GH4115	GN9125
 WNGU080608-GL	12.48	4.7	6.45	0.8				○			○	○	○	○	○				
 WNGU040304-GM WNGU040308-GM WNGU080608-GM WNGU080616-GM	6.7	3.25	3.3	0.4	●				●	●		●	●	●	●				
	6.7	3.25	3.3	0.8	●				●	●		●	●	●	●				
	12.48	4.6	6.45	0.8	●			●	●	●		●	●	●	●				
	12.48	4.6	6.45	1.6	●					●		●	●	●	●				
 WNGU080608-GH	12.48	4.6	6.45	0.8	●				●				●	●					

● Stock ○ Available Upon Order

WNGU Series Geometry

Light Cutting for General Material	Medium Cutting for General Material	Heavy Cutting for General Material
		
GL	GM	GH
		
Light cutting of low cutting force, good processing quality.	High stability in most cases.	Suitable on roughing, good edge strength.

Shoulder Milling

MEE190

Arbor

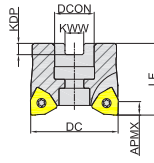

Fig1

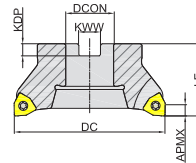

Fig2

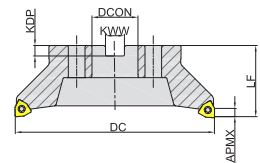

Fig3

Ordering Code	Dia-meter	Teeth	Dimension(mm)					APMX	Coolant	Suitable for	Shape	Weight (KG)	Stock
			DC	DCON	LF	KWW	KDP						
MEE190040R06A16WN04	40	6	40	16	40	8.4	5.6	4	✓	WNGU0403	Fig1	0.23	●
MEE190050R04A22WN08	50	4	50	22	40	10.4	6.3	7.5	×	WNGU0806	Fig1	0.32	●
MEE190050R05A22WN08	50	5	50	22	40	10.4	6.3	7.5	✓	WNGU0806	Fig1	0.33	●
MEE190063R06A22WN08	63	6	63	22	40	10.4	6.3	7.5	×	WNGU0806	Fig1	0.44	●
MEE190080R07A27WN08	80	7	80	27	50	12.4	7	7.5	×	WNGU0806	Fig1	1.00	●
MEE190100R08B32WN08	100	8	100	32	50	14.4	8	7.5	×	WNGU0806	Fig2	1.36	●
MEE190125R07B40WN08	125	7	125	40	63	16.4	9	7.5	×	WNGU0806	Fig2	2.74	●
MEE190125R11B40WN08	125	11	125	40	63	16.4	9	7.5	×	WNGU0806	Fig2	2.86	●
MEE190160R08C40WN08	160	8	160	40	63	16.4	9	7.5	×	WNGU0806	Fig3	3.94	●
MEE190160R12C40WN08	160	12	160	40	63	16.4	9	7.5	×	WNGU0806	Fig3	4.05	●
MEE190200R08C60WN08	200	8	200	60	63	25.7	14	7.5	×	WNGU0806	Fig3	7.28	●
MEE190200R16C60WN08	200	16	200	60	63	25.7	14	7.5	×	WNGU0806	Fig3	7.22	●

● Stock ○ Available Upon Order

Shoulder Milling

MEE190 NEW

Arbor- Unequal Blade Spacing

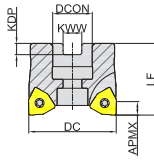

Fig1

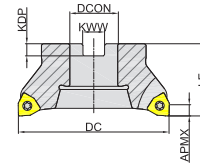

Fig2

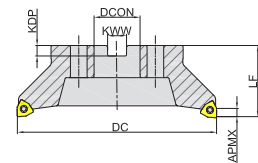

Fig3

Ordering Code	Dia-meter	Teeth	Dimension(mm)					APMX	Coolant	Suitable for	Shape	Weight (KG)	Stock
			DC	DCON	LF	KWW	KDP						
MEE190063R06A22WN08U	63	6	63	22	40	10.4	6.3	7.5	✓	WNGU0806	Fig1	0.44	●
MEE190080R07A27WN08U	80	7	80	27	50	12.4	7	7.5	✓	WNGU0806	Fig1	1.00	●
MEE190100R08B32WN08U	100	8	100	32	50	14.4	8	7.5	✓	WNGU0806	Fig2	1.36	●
MEE190125R07B40WN08U	125	7	125	40	63	16.4	9	7.5	×	WNGU0806	Fig2	2.74	●
MEE190160R08C40WN08U	160	8	160	40	63	16.4	9	7.5	×	WNGU0806	Fig3	3.94	●
MEE190200R08C60WN08U	200	8	200	60	63	25.7	14	7.5	×	WNGU0806	Fig3	7.28	●

● Stock ○ Available Upon Order

MEE190

Cylindrical Straight Type

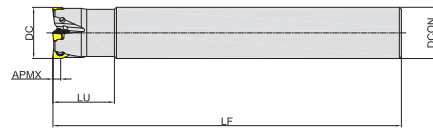

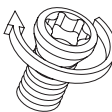
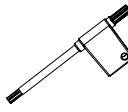



Fig4

Ordering Code	Dia-meter	Teeth	Dimension(mm)				APMX	Suitable for	Coolant	Shape	Weight (KG)	Stock
			DC	DCON	LF	LU						
MEE190020R03P20WN04	20	3	20	20	150	30	4	WNGU0403	✓	Fig4	0.33	●
MEE190025R04P25WN04	25	4	25	25	170	30	4	WNGU0403	✓	Fig4	0.60	●
MEE190032R05P32WN04	32	5	32	32	195	30	4	WNGU0403	✓	Fig4	1.14	●
MEE190035R05P32WN04	35	5	35	32	195	30	4	WNGU0403	✓	Fig4	1.16	●
MEE190040R03P32WN08	40	3	40	32	160	60.2	7.5	WNGU0806	×	Fig4	1.05	●
MEE190040R06P32WN04	40	6	40	32	195	30	4	WNGU0403	✓	Fig4	1.18	●

● Stock ○ Available Upon Order

Spare Parts

Part Name		Inserts Screw	Recommended Torque	Insert Screw Wrench	
Inserts	Shape				
	Ordering Code				
WNGU0403	Ordering Code	SI60M025065-03610IS	1.2N·m	TI07PB	—
WNGU0806	Ordering Code	SI60M040100-05510IS	3.5N·m	TI15PB	TI15TB

Recommended Cutting Data



Workpiece	Hardness	Grade	Specification	Ap (mm)	Cutting Speed Vc(m/min)	Feed Rate/Edges fz(mm)			
						Light Cutting(L)	Medium Cutting(M)	Heavy Cutting(H)	
P	Soft Steel	≤ HB180	GA4225 GA4230	WNGU0403	1.2	180 (140-220)	0.1 (0.05-0.15)	0.15 (0.1-0.2)	0.2 (0.1-0.25)
				WNGU0806			2.3	0.15 (0.1-0.2)	0.25 (0.15-0.35)
	Carbon Steel, Alloy Steel	HB180-350	GA4225 GA4230 GP2115	WNGU0403	1.2	150 (110-190)	0.1 (0.05-0.15)	0.15 (0.1-0.2)	0.2 (0.1-0.25)
				WNGU0806			2.3	0.15 (0.1-0.2)	0.25 (0.15-0.35)
	Pre-harden Steel	HRC35-45	GA4230 GA4225 GP2115	WNGU0403	1.2	150 (110-190)	0.08 (0.05-0.15)	0.1 (0.05-0.15)	0.15 (0.1-0.2)
				WNGU0806			2.3	0.1 (0.05-0.15)	0.15 (0.1-0.2)
M	Stainless (Ferrite, Martensite)	≤ HB270	GM2140 GM4135 GA4230	WNGU0403	1.2	140 (100-180)	0.12 (0.1-0.2)	0.15 (0.1-0.2)	0.2 (0.1-0.3)
				WNGU0806			2.3	0.15 (0.1-0.2)	0.25 (0.15-0.35)
	Stainless (Austenite, Diphasic)	≤ HB270	GM2140 GM4135	WNGU0403	1.2	120 (80-160)	0.1 (0.05-0.15)	0.12 (0.1-0.2)	0.15 (0.1-0.2)
				WNGU0806			2.3	0.12 (0.1-0.2)	0.15 (0.1-0.2)
K	Grey Cast Iron	≤ HB280	GK2115 GK4125	WNGU0403	1.2	180 (150-220)	0.1 (0.05-0.15)	0.15 (0.1-0.2)	0.2 (0.1-0.25)
				WNGU0806			2.3	0.15 (0.1-0.2)	0.25 (0.1-0.4)
	Nodular Cast Iron, Vermicular Graphite Cast Iron	≤ HB350	GK4125 GK2115	WNGU0403	1.2	120 (100-180)	0.1 (0.05-0.15)	0.1 (0.05-0.15)	0.2 (0.1-0.25)
				WNGU0806			2.3	0.15 (0.1-0.2)	0.25 (0.15-0.35)
S	Heat-resistant Alloy and Titanium Alloy	HRC30-45	GS4130	WNGU0403	1.2	40 (30-60)	0.08 (0.05-0.15)	0.08 (0.05-0.15)	0.1 (0.05-0.15)
				WNGU0806			2.3	0.1 (0.05-0.15)	0.1 (0.05-0.15)

Shoulder Milling

SDKT

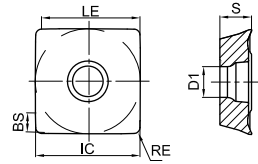





One Side Four Edge Shoulder Milling



Ordering Code	Dimension(mm)						Coating Grade										Uncoated	Cermet			
	LE	IC	S	BS	D1	RE	GA4225	GA4230	GA4325	GPM7120	GP4225	GP2115	GM4135	GM2140	GK4125	GK2115			GS4130	GH4115	GN9125
 SDKT14T3PEER-GL	13.12	13.92	3.96	2.5	4.1	0.8	●	●		●	●	●	●	●	●	●	●				
 SDKT14T3PEER-GM	13.12	13.92	3.96	2.5	4.1	0.8	●	●		●	●	●	●	●	●	●	●				
 SDKT14T3PEER-GH	13.12	13.92	3.96	2.5	4.1	0.8					●					●	●				

● Stock ○ Available Upon Order

SDKT Series Geometry

Light Cutting for General Material	Medium Cutting for General Material	Heavy Cutting for General Material
		
GL	GM	GH
		
<p>Light cutting of low cutting force, good processing quality.</p>	<p>High stability in most cases.</p>	<p>Suitable on roughing, good edge strength.</p>

Shoulder Milling

MES190

Arbor

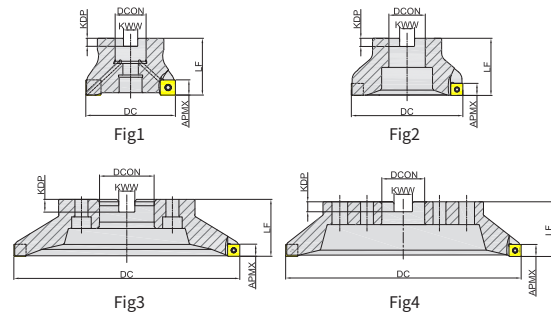
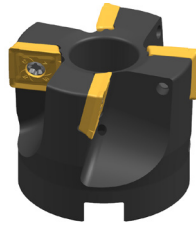

Sparse Pitch

Ordering Code	Dia-meter	Teeth	Dimension(mm)					APMX	Coolant	Suitable for	Shape	Weight (KG)	Stock
			DC	DCON	LF	KWW	KDP						
MES190050R04A22SD14	50	4	50	22	40	10.4	6.3	10	✓	SDKT14T3	Fig1	0.27	●
MES190063R05A22SD14	63	5	63	22	40	10.4	6.3	10	✓	SDKT14T3	Fig1	0.38	●
MES190080R06A27SD14	80	6	80	27	50	12.4	7	10	✓	SDKT14T3	Fig1	0.91	●
MES190100R07B32SD14	100	7	100	32	50	14.4	8	10	×	SDKT14T3	Fig2	1.29	●
MES190125R08B40SD14	125	8	125	40	63	16.4	9	10	×	SDKT14T3	Fig2	2.48	●
MES190160R08C40SD14	160	8	160	40	63	16.4	9	10	×	SDKT14T3	Fig3	4.36	○
MES190200R10C60SD14	200	10	200	60	63	25.7	14	10	×	SDKT14T3	Fig3	6.61	●
MES190250R12C60SD14	250	12	250	60	63	25.7	14	10	×	SDKT14T3	Fig3	8.76	○
MES190315R15D60SD14	315	15	315	60	80	25.7	14	10	×	SDKT14T3	Fig4	16.87	○

● Stock ○ Available Upon Order

Dense Pitch

Ordering Code	Dia-meter	Teeth	Dimension(mm)					APMX	Coolant	Suitable for	Shape	Weight (KG)	Stock
			DC	DCON	LF	KWW	KDP						
MES190050R05A22SD14	50	5	50	22	40	10.4	6.3	10	✓	SDKT14T3	Fig1	0.26	●
MES190063R06A22SD14	63	6	63	22	40	10.4	6.3	10	✓	SDKT14T3	Fig1	0.40	●
MES190080R08A27SD14	80	8	80	27	50	12.4	7	10	✓	SDKT14T3	Fig1	0.90	●
MES190100R08B32SD14	100	8	100	32	50	14.4	8	10	×	SDKT14T3	Fig2	1.23	●
MES190125R10B40SD14	125	10	125	40	63	16.4	9	10	×	SDKT14T3	Fig2	2.40	●
MES190160R12C40SD14	160	12	160	40	63	16.4	9	10	×	SDKT14T3	Fig3	4.13	●
MES190200R16C60SD14	200	16	200	60	63	25.7	14	10	×	SDKT14T3	Fig3	6.61	●
MES190250R18C60SD14	250	18	250	60	63	25.7	14	10	×	SDKT14T3	Fig3	8.53	○
MES190315R24D60SD14	315	24	315	60	80	25.7	14	10	×	SDKT14T3	Fig4	16.47	○

● Stock ○ Available Upon Order

Shoulder Milling

MES190

Side Clamp Type/Cylindrical Straight Type

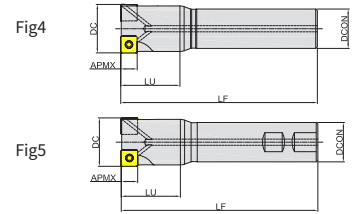

Ordering Code	Dia-meter	Teeth	Dimension(mm)				APMX	Suitable for	Coolant	Shape	Weight (KG)	Stock
			DC	DCON	LF	LU						
MES190040R03P20SD14	40	3	40	20	120	60	10	SDKT14T3	✓	Fig4	0.42	○
MES190040R03W32SD14	40	3	40	32	160	62	10	SDKT14T3	✓	Fig5	0.96	●
MES190040R04W32SD14	40	4	40	32	160	62	10	SDKT14T3	✓	Fig5	0.98	●
MES190050R04W32SD14	50	4	50	32	160	76	10	SDKT14T3	✓	Fig5	1.25	●
MES190050R05W32SD14	50	5	50	32	160	76	10	SDKT14T3	✓	Fig5	1.25	●

● Stock ○ Available Upon Order

Spare Parts

Part Name		Inserts Screw	Recommended Torque	Insert Screw Wrench	
Inserts	Shape				
	Ordering Code	SI60M035100-05018IS	3.0N · m	TI15PB	TI15TB

Recommended Cutting Data

Workpiece	Hardness	Grade	Specification	Ap (mm)	Cutting Speed Vc(m/min)	Feed Rate/Edges fz(mm)			
						Light Cutting(L)	Medium Cutting(M)	Heavy Cutting(H)	
P	Soft Steel	≤ HB180	GPM7120 GA4225 GA4230	SDKT14T3	3	180 (140-220)	0.2 (0.1-0.3)	0.25 (0.15-0.35)	0.3 (0.2-0.4)
	Carbon Steel, Alloy Steel	HB180-350	GPM7120 GA4225 GA4230 GP2115	SDKT14T3	3	150 (110-190)	0.2 (0.1-0.3)	0.25 (0.15-0.35)	0.3 (0.2-0.4)
	Pre-harden Steel	HRC35-45	GPM7120 GA4230 GA4225 GP2115	SDKT14T3	3	150 (110-190)	0.1 (0.05-0.15)	0.15 (0.1-0.2)	0.2 (0.1-0.3)
M	Stainless (Ferrite, Martensite)	≤ HB270	GM2140 GM4135 GA4230	SDKT14T3	3	140 (100-180)	0.12 (0.1-0.2)	0.15 (0.1-0.2)	0.2 (0.1-0.3)
	Stainless (Austenite, Diphasic)	≤ HB270	GM2140 GM4135	SDKT14T3	3	120 (80-160)	0.1 (0.05-0.15)	0.15 (0.1-0.2)	0.2 (0.1-0.3)
K	Grey Cast Iron	≤ HB280	GK2115 GK4125	SDKT14T3	3	180 (140-220)	0.2 (0.1-0.3)	0.25 (0.1-0.4)	0.3 (0.2-0.5)
	Nodular Cast Iron, Vermicular Graphite Cast Iron	≤ HB350	GK4125 GK2115	SDKT14T3	3	140 (100-180)	0.1 (0.05-0.15)	0.15 (0.1-0.2)	0.2 (0.1-0.25)
S	Heat- resistant Alloy and Titanium Alloy	HRC30-45	GS4130	SDKT14T3	3	40 (30-60)	0.1 (0.05-0.15)	0.1 (0.05-0.15)	0.15 (0.1-0.2)

Shoulder Milling

XDHT

Shoulder Milling Insert For Aluminium

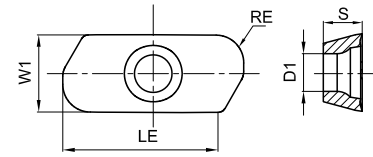

Ordering Code	Dimension(mm)					Coating Grade										Uncoated	Cermat			
	LE	W1	S	D1	RE	GA4225	GA4230	GA4325	GPM7120	GP4225	GP2115	GM4135	GM2140	GK4125	GK2115			GS4130	GH4115	GN9125
XDHT190402FR-AL	19	9.5	4.76	4.6	0.2															●
XDHT190408FR-AL	19	9.5	4.76	4.6	0.8															●
XDHT190420FR-AL	19	9.5	4.76	4.6	2.0															●
XDHT190432FR-AL	19	9.5	4.76	4.6	3.2															●
XDHT190440FR-AL	19	9.5	4.76	4.6	4.0															●
XDHT190450FR-AL	19	9.5	4.76	4.6	5.0															●



● Stock ○ Available Upon Order

XDHT Series Geometry

General Cutting for Aluminum Alloys



AL



Large rake angle, sharp edge, light cutting, polishing and good chip removal

Shoulder Milling

MEH190

Arbor

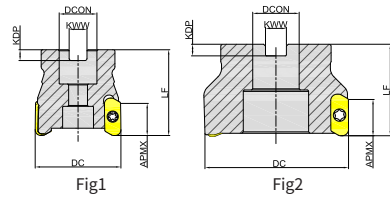

Ordering Code	Dia-meter	Teeth	Dimension(mm)					APMX	Suitable for	Coolant	Shape	Weight (KG)	Stock
			DC	DCON	LF	KWW	KDP						
MEH190040R03A16XD19	40	3	40	16	50	8.4	5.6	18	XDHT1904(RE ≤ 4)	×	Fig1	0.23	●
MEH190050R04A22XD19	50	4	50	22	50	10.4	6.3	18	XDHT1904(RE ≤ 4)	×	Fig1	0.35	●
MEH190063R04A22XD19	63	4	63	22	50	10.4	6.3	18	XDHT1904(RE ≤ 4)	×	Fig1	0.56	●
MEH190063R05A22XD19	63	5	63	22	50	10.4	6.3	18	XDHT1904(RE ≤ 4)	×	Fig1	0.58	●
MEH190080R04A27XD19	80	4	80	27	50	12.4	7	18	XDHT1904(RE ≤ 4)	×	Fig1	0.92	●
MEH190080R05A27XD19	80	5	80	27	50	12.4	7	18	XDHT1904(RE ≤ 4)	×	Fig1	0.86	●
MEH190100R05B32XD19	100	5	100	32	50	14.4	8	18	XDHT1904(RE ≤ 4)	×	Fig2	1.39	●
MEH190100R08B32XD19	100	8	100	32	50	14.4	8	18	XDHT1904(RE ≤ 4)	×	Fig2	1.52	●
MEH190125R05B40XD19	125	5	125	40	63	16.4	9	18	XDHT1904(RE ≤ 4)	×	Fig2	2.59	●
MEH190125R06B40XD19	125	6	125	40	63	16.4	9	18	XDHT1904(RE ≤ 4)	×	Fig2	2.53	●

● Stock ○ Available Upon Order

Shoulder Milling

MEH190

Cylindrical Straight Type

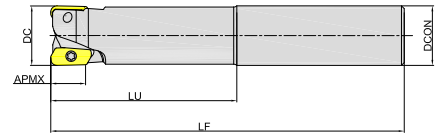

Fig3

Ordering Code	Dia-meter	Teeth	Dimension(mm)				APMX	Suitable for	Coolant	Shape	Weight (KG)	Stock
			DC	DCON	LF	LU						
MEH190025R02P25XD19	25	2	25	25	121	50	18	XDHT1904(RE ≤ 4)	×	Fig3	0.38	●
MEH190025R02P25XD19L	25	2	25	25	165	63	18	XDHT1904(RE ≤ 4)	×	Fig3	0.54	●
MEH190032R02P32XD19S	32	2	32	32	125	65	18	XDHT1904(RE ≤ 4)	×	Fig3	0.64	●
MEH190032R02P32XD19	32	2	32	32	165	80	18	XDHT1904(RE ≤ 4)	×	Fig3	0.88	●
MEH190032R02P32XD19L	32	2	32	32	190	100	18	XDHT1904(RE ≤ 4)	×	Fig3	1.07	●
MEH190032R03P32XD19S	32	3	32	32	125	65	18	XDHT1904(RE ≤ 4)	×	Fig3	0.65	●
MEH190032R03P32XD19	32	3	32	32	165	80	18	XDHT1904(RE ≤ 4)	×	Fig3	0.89	●
MEH190032R03P32XD19L	32	3	32	32	190	100	18	XDHT1904(RE ≤ 4)	×	Fig3	1.03	●

● Stock ○ Available Upon Order

MEH190

Replaceable Tool Head

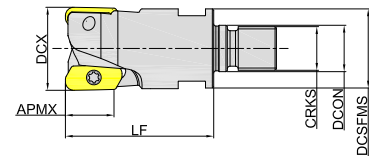

Fig4

Ordering Code	Dia-meter	Teeth	Dimension(mm)					APMX	Suitable for	Coolant	Shape	Weight (KG)	Stock
			DCX	DCON	DCSFMS	LF	CRKS						
MEH190025R02M12XD19	25	2	25	12.5	24	45	M12	18	XDHT1904(RE ≤ 4)	×	Fig4	0.20	●
MEH190032R03M16XD19	32	3	32	17	29	52	M16	18	XDHT1904(RE ≤ 4)	×	Fig4	0.35	●
MEH190040R03M16XD19	40	3	40	17	32	52	M16	18	XDHT1904(RE ≤ 4)	×	Fig4	0.55	●

● Stock ○ Available Upon Order

Shoulder Milling

MEH190

Integrated Cutter-HSK63A

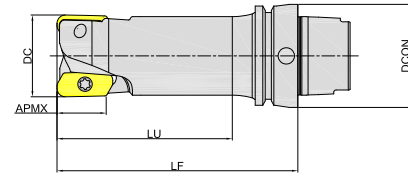

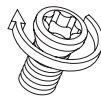
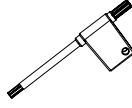
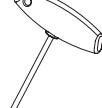

Fig5

Ordering Code	Dia-meter	Teeth	Dimension(mm)				APMX	Suitable for	Coolant	Shape	Weight (KG)	Stock
			DC	DCON	LF	LU						
MEH190025R02HA63XD19S	25	2	25	63	90	50	18	XDHT1904(RE ≤ 4)	×	Fig5	0.85	●
MEH190025R02HA63XD19	25	2	25	63	100	63	18	XDHT1904(RE ≤ 4)	×	Fig5	0.86	●
MEH190032R02HA63XD19S	32	2	32	63	100	63	18	XDHT1904(RE ≤ 4)	×	Fig5	1.00	●
MEH190032R02HA63XD19	32	2	32	63	120	80	18	XDHT1904(RE ≤ 4)	×	Fig5	1.10	●
MEH190032R03HA63XD19S	32	3	32	63	100	63	18	XDHT1904(RE ≤ 4)	×	Fig5	1.00	●
MEH190032R03HA63XD19	32	3	32	63	120	80	18	XDHT1904(RE ≤ 4)	×	Fig5	1.10	●
MEH190040R03HA63XD19S	40	3	40	63	100	63	18	XDHT1904(RE ≤ 4)	×	Fig5	1.20	●
MEH190040R03HA63XD19	40	3	40	63	120	80	18	XDHT1904(RE ≤ 4)	×	Fig5	1.30	●

● Stock ○ Available Upon Order

Spare Parts

Part Name		Inserts Screw	Recommended Torque	Insert Screw Wrench	
Inserts	Shape				
	Ordering Code	SI60M040075-05505WW	3.5N·m	TT15PB	TT15TB

Recommended Cutting Data

Workpiece	Hardness	Grade	Specification	Ap (mm)	Cutting Speed Vc(m/min)	Feed Rate/Edges fz(mm)		
						Light Cutting(L)	Medium Cutting(M)	Heavy Cutting(H)
N Aluminium	HB60-210	GN9125	XDHT1904	7	≥ 300	0.15 (0.1-0.2)	0.2 (0.1-0.3)	0.3 (0.2-0.4)

Shoulder Milling

APEW **NEW**

Positive two edges shoulder milling

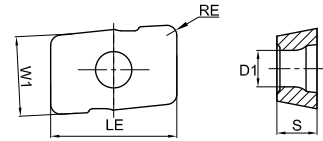

Ordering Code	Dimension(mm)					Coating Grade										Uncoated	Cermet						
	LE	W1	S	D1	RE	GA4225	GA4230	GA4325	GPM7120	GP4225	GP2115	GM4135	GM2140	GK4125	GK2115			GS4130	GH4115	GN9125	GP01TM		
 APEW100308-GH	10	7	3.18	2.9	0.8																●		

● Stock ○ Available Upon Order

APEW Series Geometry

Cutting For dead-hard steel



GH



Fine-grinding and polishing, it is suitable for semi-finishing and finishing.

Shoulder Milling

MEJ190

Replaceable Tool Head

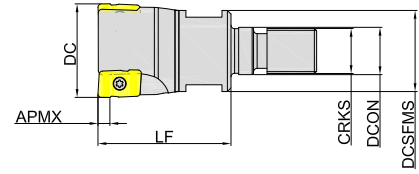

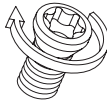
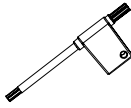

Fig1

Ordering Code	Dia-meter	Teeth	Dimension(mm)					APMX	Suitable for	Coolant	Shape	Weight (kg)	Stock
			DC	DCSFMS	DCON	LF	CRKS						
MEJ190017R02M08AP10S	17	3	17	15.5	8.5	25	8	2.5	APEW1003	×	Fig1	0.03	●
MEJ190021R02M10AP10	21	2	21	18	10.5	30	10	2.5	APEW1003	×	Fig1	0.06	●
MEJ190021R03M10AP10	21	3	21	18	10.5	30	10	2.5	APEW1003	×	Fig1	0.06	●
MEJ190026R03M12AP10	26	3	26	23	12.5	35	12	2.5	APEW1003	×	Fig1	0.11	●

● Stock ○ Available Upon Order

Spare Parts

Part Name		Inserts Screw	Recommended Torque	Insert Screw Wrench
Inserts	Shape			
	APEW1003 Ordering Code	SI60M025065-03509S	1.0N·m	TT07PQ

Recommended Cutting Data





Workpiece	Hardness	Grade	Cutting Speed Vc(m/min)	Specification	Feed Rate/Edges fz(mm)		
					Light Cutting(L)	Medium Cutting(M)	Heavy Cutting(H)
 Hardened Steel	HRC48-55	GH4115	80 (60-120)	10	0.15 (0.1-0.2)	0.2 (0.1-0.3)	0.3 (0.2-0.4)

Shoulder Milling

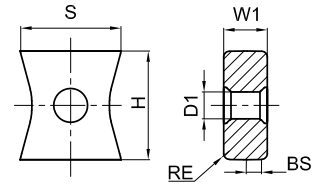
LNE(M)T









Vertically Eight Edge Milling Insert

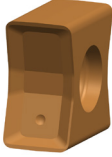

Ordering Code	Dimension(mm)						Coating Grade										Uncoated	Cermat					
	H	W1	D1	S	RE	BS	GA4225	GA4230	GA4325	GPM7120	GP4225	GP2115	GM4135	GM2140	GK4125	GK2115			GS4130	GH4115	GN9125	GP01TM	
 LNET110608-GL	11.2	6	5	11	0.8	2	●				●		●		●								
	LNET150608-GL	15.0	6	7	13.9	0.8	2	●			●		●	●	●								
 LNMT110608-GM	11.2	6	5	11	0.8	2	●			●	●		●	●	●								
	LNMT150608-MM	15.0	6	7	13.9	0.8	2	●		●	●		●	●	●	●							
 LNMT110608-GH	11.2	6	5	11	0.8	2	●			●													
	LNMT150608-GH	15.0	6	7	13.9	0.8	2	●		●					●	●							
 LNET1106PNEN-W	11.4	6	5	11	—	4.6									●								
	LNET1506PNTN-W	15.2	6	7	13.9	—	4.8								●								

● Stock ○ Available Upon Order

LNE(M)T Series Geometry

Light Cutting for General Material	Medium Cutting for General Material	Stainless Steel Medium Cutting	Heavy Cutting for General Material	Wiper
				
GL	GM	MM	GH	W
				
Low cutting resistance of light load cutting, better processing quality.	High stability machining is achieved under general working conditions.	Under the general working conditions, stainless steel material is realized High stability machining.	High strength cutting edge, excellent performance when cutting intermittently and removing black skin.	High precision wiped edge, improve surface quality.

Shoulder Milling

MVA190

Arbor

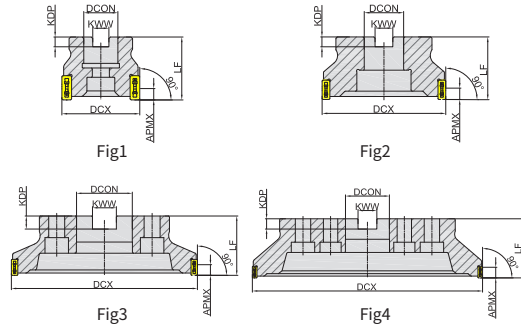

Sparse Pitch

Ordering Code	Dia-meter	Teeth	Dimension(mm)					APMX	Suitable for	Coolant	Shape	Weight (KG)	Stock
			DCX	DCON	LF	KWW	KDP						
MVA190040R04A16LN11	40	4	40	16	40	8.4	5.6	5	LNE(M)T1106	×	Fig1	0.21	○
MVA190040L04A16LN11	40	4	40	16	40	8.4	5.6	5	LNE(M)T1106	×	Fig1	0.21	○
MVA190050R05A22LN11	50	5	50	22	40	10.4	6.3	5	LNE(M)T1106	×	Fig1	0.29	●
MVA190050L05A22LN11	50	5	50	22	40	10.4	6.3	5	LNE(M)T1106	×	Fig1	0.29	●
MVA190063R06A22LN11	63	6	63	22	40	10.4	6.3	5	LNE(M)T1106	×	Fig1	0.50	●
MVA190063L06A22LN11	63	6	63	22	40	10.4	6.3	5	LNE(M)T1106	×	Fig1	0.50	●
MVA190080R08B27LN11	80	8	80	27	50	12.4	7	5	LNE(M)T1106	×	Fig2	0.89	●
MVA190080L08B27LN11	80	8	80	27	50	12.4	7	5	LNE(M)T1106	×	Fig2	0.89	○
MVA190100R09B32LN11	100	9	100	32	50	14.4	8	5	LNE(M)T1106	×	Fig2	1.55	●
MVA190100L09B32LN11	100	9	100	32	50	14.4	8	5	LNE(M)T1106	×	Fig2	1.55	○
MVA190125R10B40LN11	125	10	125	40	63	16.4	9	5	LNE(M)T1106	×	Fig2	2.74	●
MVA190125L10B40LN11	125	10	125	40	63	16.4	9	5	LNE(M)T1106	×	Fig2	2.74	○
MVA190160R12C40LN11	160	12	160	40	63	16.4	9	5	LNE(M)T1106	×	Fig3	3.90	●
MVA190160L12C40LN11	160	12	160	40	63	16.4	9	5	LNE(M)T1106	×	Fig3	3.90	○
MVA190200R16C60LN11	200	16	200	60	63	25.7	14	5	LNE(M)T1106	×	Fig3	5.36	●
MVA190200L16C60LN11	200	16	200	60	63	25.7	14	5	LNE(M)T1106	×	Fig3	5.36	○

● Stock ○ Available Upon Order

 workpiece	Diameter	Angle of Overcutting	Tool Cutting Edge Angle
	DCX ≤ 50mm	α=8.5°	Kr=91°
	DCX=63mm	α=7.5°	Kr=91°
	DCX=80mm	α=7.5°	Kr=91°
	DCX ≥ 100mm	α=5°	Kr=90°

Note: Overcutting will occur when the total cutting depth is > 7mm, as shown in the table above.

Shoulder Milling

MVA190

Arbor

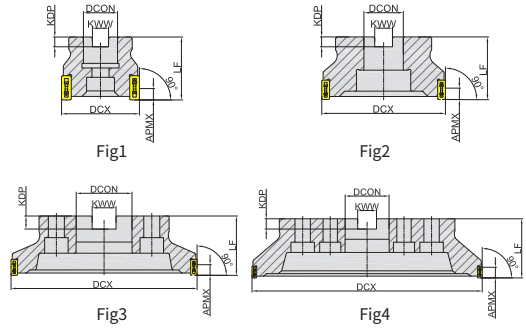

Dense Pitch

Ordering Code	Dia-meter	Teeth	Dimension(mm)					APMX	Suitable for	Coolant	Shape	Weight (KG)	Stock
			DCX	DCON	LF	KWW	KDP						
MVA190040R05A16LN11	40	5	40	16	40	8.4	5.6	5	LNE(M)T1106	×	Fig1	0.21	○
MVA190040L05A16LN11	40	5	40	16	40	8.4	5.6	5	LNE(M)T1106	×	Fig1	0.21	○
MVA190050R07A22LN11	50	7	50	22	40	10.4	6.3	5	LNE(M)T1106	×	Fig1	0.30	○
MVA190050L07A22LN11	50	7	50	22	40	10.4	6.3	5	LNE(M)T1106	×	Fig1	0.30	○
MVA190063R09A22LN11	63	9	63	22	40	10.4	6.3	5	LNE(M)T1106	×	Fig1	0.50	●
MVA190063L09A22LN11	63	9	63	22	40	10.4	6.3	5	LNE(M)T1106	×	Fig1	0.50	○
MVA190080R11B27LN11	80	11	80	27	50	12.4	7	5	LNE(M)T1106	×	Fig2	0.90	○
MVA190080L11B27LN11	80	11	80	27	50	12.4	7	5	LNE(M)T1106	×	Fig2	0.90	○
MVA190100R14B32LN11	100	14	100	32	50	14.4	8	5	LNE(M)T1106	×	Fig2	1.55	○
MVA190100L14B32LN11	100	14	100	32	50	14.4	8	5	LNE(M)T1106	×	Fig2	1.55	○
MVA190125R18B40LN11	125	18	125	40	63	16.4	9	5	LNE(M)T1106	×	Fig2	2.74	○
MVA190125L18B40LN11	125	18	125	40	63	16.4	9	5	LNE(M)T1106	×	Fig2	2.74	○
MVA190160R23C40LN11	160	23	160	40	63	16.4	9	5	LNE(M)T1106	×	Fig3	3.91	○
MVA190160L23C40LN11	160	23	160	40	63	16.4	9	5	LNE(M)T1106	×	Fig3	3.91	○
MVA190200R28C60LN11	200	28	200	60	63	25.7	14	5	LNE(M)T1106	×	Fig3	5.37	○
MVA190200L28C60LN11	200	28	200	60	63	25.7	14	5	LNE(M)T1106	×	Fig3	5.37	○

● Stock ○ Available Upon Order

<p>workpiece</p>	Diameter	Angle of Overcutting	Tool Cutting Edge Angle
	DCX ≤ 50mm	α=8.5°	Kr=91°
	DCX=63mm	α=7.5°	Kr=91°
	DCX=80mm	α=7.5°	Kr=91°
	DCX ≥ 100mm	α=5°	Kr=90°

Note: Overcutting will occur when the total cutting depth is > 7mm, as shown in the table above.

Shoulder Milling

MVA190

Arbor

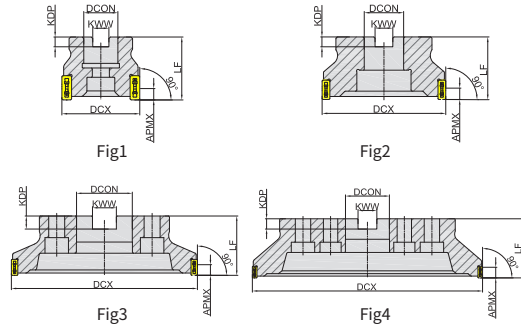

Sparse Pitch

Ordering Code	Dia-meter	Teeth	Dimension(mm)					APMX	Suitable for	Coolant	Shape	Weight (KG)	Stock
			DCX	DCON	LF	KWW	KDP						
MVA190050R04A22LN15	50	4	50	22	40	10.4	6.3	7	LNE(M)T1506	×	Fig1	0.30	●
MVA190050L04A22LN15	50	4	50	22	40	10.4	6.3	7	LNE(M)T1506	×	Fig1	0.30	○
MVA190063R05A22LN15	63	5	63	22	40	10.4	6.3	7	LNE(M)T1506	×	Fig1	0.52	●
MVA190063L05A22LN15	63	5	63	22	40	10.4	6.3	7	LNE(M)T1506	×	Fig1	0.52	●
MVA190080R06B27LN15	80	6	80	27	50	12.4	7	7	LNE(M)T1506	×	Fig2	0.92	●
MVA190080L06B27LN15	80	6	80	27	50	12.4	7	7	LNE(M)T1506	×	Fig2	0.92	○
MVA190100R08B32LN15	100	8	100	32	50	14.4	8	7	LNE(M)T1506	×	Fig2	1.59	●
MVA190100L08B32LN15	100	8	100	32	50	14.4	8	7	LNE(M)T1506	×	Fig2	1.59	○
MVA190125R10B40LN15	125	10	125	40	63	16.4	9	7	LNE(M)T1506	×	Fig2	2.86	●
MVA190125L10B40LN15	125	10	125	40	63	16.4	9	7	LNE(M)T1506	×	Fig2	2.86	○
MVA190160R12C40LN15	160	12	160	40	63	16.4	9	7	LNE(M)T1506	×	Fig3	4.39	●
MVA190160L12C40LN15	160	12	160	40	63	16.4	9	7	LNE(M)T1506	×	Fig3	4.39	○
MVA190200R12C60LN15	200	12	200	60	63	25.7	14	7	LNE(M)T1506	×	Fig3	5.73	●
MVA190200L12C60LN15	200	12	200	60	63	25.7	14	7	LNE(M)T1506	×	Fig3	5.73	○
MVA190200R15C60LN15	200	15	200	60	63	25.7	14	7	LNE(M)T1506	×	Fig3	5.86	○
MVA190200L15C60LN15	200	15	200	60	63	25.7	14	7	LNE(M)T1506	×	Fig3	5.86	○
MVA190250R15C60LN15	250	15	250	60	63	25.7	14	7	LNE(M)T1506	×	Fig3	11.45	○
MVA190250L15C60LN15	250	15	250	60	63	25.7	14	7	LNE(M)T1506	×	Fig3	11.45	○
MVA190250R20C60LN15	250	20	250	60	63	25.7	14	7	LNE(M)T1506	×	Fig3	11.65	○
MVA190250L20C60LN15	250	20	250	60	63	25.7	14	7	LNE(M)T1506	×	Fig3	11.65	○
MVA190315R18D60LN15	315	18	315	60	80	25.7	14	7	LNE(M)T1506	×	Fig4	22.06	○
MVA190315L18D60LN15	315	18	315	60	80	25.7	14	7	LNE(M)T1506	×	Fig4	22.06	○
MVA190315R25D60LN15	315	25	315	60	80	25.7	14	7	LNE(M)T1506	×	Fig4	22.41	○
MVA190315L25D60LN15	315	25	315	60	80	25.7	14	7	LNE(M)T1506	×	Fig4	22.41	○

● Stock ○ Available Upon Order

Diameter	Angle of Overcutting	Tool Cutting Edge Angle
DCX=50mm	$\alpha=8^\circ$	Kr=91°
DCX=63mm	$\alpha=7^\circ$	Kr=90.5°
DCX=80mm	$\alpha=7^\circ$	Kr=90.5°
DCX ≥ 100mm	$\alpha=5^\circ$	Kr=90°

Note: Overcutting will occur when the total cutting depth is > 7mm, as shown in the table above.

Shoulder Milling

MVA190

Arbor

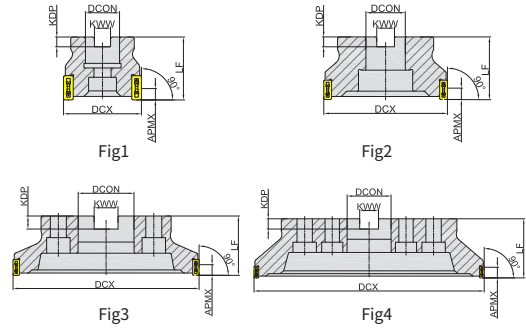

Dense Pitch

Ordering Code	Dia-meter	Teeth	Dimension(mm)					APMX	Suitable for	Coolant	Shape	Weight (KG)	Stock
			DCX	DCON	LF	KWW	KDP						
MVA190050R05A22LN15	50	5	50	22	40	10.4	6.3	7	LNE(M)T1506	×	Fig1	0.29	●
MVA190050L05A22LN15	50	5	50	22	40	10.4	6.3	7	LNE(M)T1506	×	Fig1	0.29	○
MVA190063R06A22LN15	63	6	63	22	40	10.4	6.3	7	LNE(M)T1506	×	Fig1	0.51	○
MVA190063L06A22LN15	63	6	63	22	40	10.4	6.3	7	LNE(M)T1506	×	Fig1	0.51	○
MVA190080R08B27LN15	80	8	80	27	50	12.4	7	7	LNE(M)T1506	×	Fig2	0.93	●
MVA190080L08B27LN15	80	8	80	27	50	12.4	7	7	LNE(M)T1506	×	Fig2	0.93	○
MVA190100R10B32LN15	100	10	100	32	50	14.4	8	7	LNE(M)T1506	×	Fig2	1.60	●
MVA190100L10B32LN15	100	10	100	32	50	14.4	8	7	LNE(M)T1506	×	Fig2	1.60	○
MVA190125R12B40LN15	125	12	125	40	63	16.4	9	7	LNE(M)T1506	×	Fig2	2.86	○
MVA190125L12B40LN15	125	12	125	40	63	16.4	9	7	LNE(M)T1506	×	Fig2	2.86	○
MVA190160R15C40LN15	160	15	160	40	63	16.4	9	7	LNE(M)T1506	×	Fig3	4.39	○
MVA190160L15C40LN15	160	15	160	40	63	16.4	9	7	LNE(M)T1506	×	Fig3	4.39	○
MVA190200R20C60LN15	200	20	200	60	63	25.7	14	7	LNE(M)T1506	×	Fig3	5.87	○
MVA190200L20C60LN15	200	20	200	60	63	25.7	14	7	LNE(M)T1506	×	Fig3	5.87	○
MVA190250R25C60LN15	250	25	250	60	63	25.7	14	7	LNE(M)T1506	×	Fig3	11.64	○
MVA190250L25C60LN15	250	25	250	60	63	25.7	14	7	LNE(M)T1506	×	Fig3	11.64	○
MVA190315R30D60LN15	315	30	315	60	80	25.7	14	7	LNE(M)T1506	×	Fig4	22.37	○
MVA190315L30D60LN15	315	30	315	60	80	25.7	14	7	LNE(M)T1506	×	Fig4	22.37	○

● Stock ○ Available Upon Order

<p>workpiece</p>	Diameter	Angle of Overcutting	Tool Cutting Edge Angle
	DCX=50mm	$\alpha=8^\circ$	Kr=91°
	DCX=63mm	$\alpha=7^\circ$	Kr=90.5°
	DCX=80mm	$\alpha=7^\circ$	Kr=90.5°
	DCX \geq 100mm	$\alpha=5^\circ$	Kr=90°

Note: Overcutting will occur when the total cutting depth is > 7mm, as shown in the table above.

Shoulder Milling

MVA290

Shell

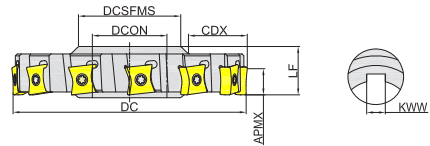
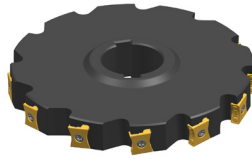

Fig5

Ordering Code	Dia-meter	Teeth	Dimension(mm)							APMX	Suitable for	Coolant	Shape	Weight (KG)	Stock
			DC	CDX	DCON	DCSFMS	KWW	LF							
MVA290080R08K27LN15	80	8	80	18	27	41	7	24	7	LNE(M)T1506	×	Fig5	0.56	○	
MVA290080L08K27LN15	80	8	80	18	27	41	7	24	7	LNE(M)T1506	×	Fig5	0.56	○	
MVA290100R10K32LN15	100	10	100	23	32	47	8	26	7	LNE(M)T1506	×	Fig5	0.91	○	
MVA290100L10K32LN15	100	10	100	23	32	47	8	26	7	LNE(M)T1506	×	Fig5	0.91	○	
MVA290125R12K40LN15	125	12	125	32	40	55	10	26	7	LNE(M)T1506	×	Fig5	1.45	○	
MVA290125L12K40LN15	125	12	125	32	40	55	10	26	7	LNE(M)T1506	×	Fig5	1.45	○	
MVA290160R15K40LN15	160	15	160	49	40	55	10	26	7	LNE(M)T1506	×	Fig5	2.50	○	
MVA290160L15K40LN15	160	15	160	49	40	55	10	26	7	LNE(M)T1506	×	Fig5	2.50	○	
MVA290200R20K50LN15	200	20	200	63	50	68	12	28	7	LNE(M)T1506	×	Fig5	4.44	○	
MVA290200L20K50LN15	200	20	200	63	50	68	12	28	7	LNE(M)T1506	×	Fig5	4.44	○	
MVA290250R25K60LN15	250	25	250	80	60	84	14	28	7	LNE(M)T1506	×	Fig5	6.99	○	
MVA290250L25K60LN15	250	25	250	80	60	84	14	28	7	LNE(M)T1506	×	Fig5	6.99	○	

● Stock ○ Available Upon Order

 workpiece	Diameter	Angle of Overcutting	Tool Cutting Edge Angle
	DCX=50mm	$\alpha=8^\circ$	Kr=91°
	DCX=63mm	$\alpha=7^\circ$	Kr=90.5°
	DCX=80mm	$\alpha=7^\circ$	Kr=90.5°
	DCX ≥ 100mm	$\alpha=5^\circ$	Kr=90°

Note: Overcutting will occur when the total cutting depth is > 7mm, as shown in the table above.

Spare Parts

Part Name		Inserts Screw	Recommended Torque	Insert Screw Wrench	
Inserts	Shape				
	Ordering Code	SI60M035094-04909IB	3.0N · m	TI10PB	TI10TB
	Ordering Code	SI60M040110-05708IB	4.0N · m	TI15PB	TI15TB

Recommended Cutting Data

Workpiece	Hardness	Grade	Specification	Ap (mm)	Cutting Speed Vc(m/min)	Feed Rate/Edges fz(mm)			
						Light Cutting(L)	Medium Cutting(M)	Heavy Cutting(H)	
P	Soft Steel	≤ HB180	GPM7120 GA4225 GA4230	LNE(M)T1106	2.5	220 (180-260)	0.1 (0.05-0.15)	0.15 (0.1-0.2)	0.2 (0.15-0.25)
			LNE(M)T1506	3.5	0.2 (0.1-0.3)		0.25 (0.1-0.4)	0.3 (0.2-0.5)	
	Carbon Steel, Alloy Steel	HB180-350	GPM7120 GA4225 GA4230 GP2115	LNE(M)T1106	2.5	180 (140-220)	0.1 (0.05-0.15)	0.15 (0.1-0.2)	0.2 (0.15-0.25)
			LNE(M)T1506	3.5	0.2 (0.1-0.3)		0.25 (0.1-0.4)	0.3 (0.2-0.5)	
	Pre-hardened Steel	HRC35-45	GPM7120 GA4230 GA4225 GP2115	LNE(M)T1106	2.5	160 (120-200)	0.06 (0.05-0.1)	0.1 (0.05-0.15)	0.15 (0.1-0.2)
			LNE(M)T1506	3.5	0.1 (0.05-0.15)		0.15 (0.1-0.2)	0.2 (0.15-0.25)	
M	Stainless (Ferrite, Martensite)	≤ HB270	GM2140 GM4135 GA4230	LNE(M)T1106	2.5	160 (120-200)	0.1 (0.05-0.15)	0.15 (0.1-0.2)	0.2 (0.15-0.25)
			LNE(M)T1506	3.5	0.15 (0.1-0.2)		0.25 (0.15-0.35)	0.3 (0.2-0.4)	
	Stainless (Austenite, Diphasic)	≤ HB270	GM2140 GM4135	LNE(M)T1106	2.5	140 (100-180)	0.06 (0.05-0.1)	0.1 (0.05-0.15)	0.15 (0.1-0.2)
				LNE(M)T1506	3.5		0.1 (0.05-0.15)	0.15 (0.1-0.2)	0.2 (0.15-0.25)
K	Grey Cast Iron	≤ HB280	GK2115 GK4125	LNE(M)T1106	2.5	220 (180-260)	0.2 (0.1-0.3)	0.25 (0.1-0.4)	0.3 (0.2-0.5)
			LNE(M)T1506	3.5	0.2 (0.1-0.3)		0.25 (0.1-0.4)	0.3 (0.2-0.5)	
	Nodular Cast Iron, Vermicular Graphite Cast Iron	≤ HB350	GK4125 GK2115	LNE(M)T1106	2.5	140 (100-180)	0.1 (0.05-0.15)	0.15 (0.1-0.2)	0.2 (0.15-0.25)
				LNE(M)T1506	3.5		0.1 (0.05-0.15)	0.15 (0.1-0.2)	0.2 (0.15-0.25)

Profile Milling

RD

Profile Milling Inserts (Positive)

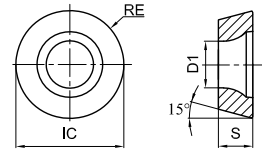

Ordering Code	Dimension(mm)				Coating Grade										Uncoated	Cermat		
	IC	S	RE	D1	GA4225	GA4230	GA4325	GPM7120	GP4225	GP2115	GM4135	GM2140	GK4125	GK2115			GS4130	GH4115
	RDET0803M0-BL	8	3.18	4	2.9	○	○											
	RDET1003M0-BL	10	3.18	5	4.4	○	○	○										
	RDET10T3M0-BL	10	3.97	5	4.4	○	○											
	RDET1204M0-BL	12	4.76	6	4.4	●	○											
	RDET1604M0-BL	16	4.76	8	5.5			○										
	RDET0802M0-GM	8	2.38	4	2.9	●	○	●	○						○			
	RDET0803M0-GM	8	3.18	4	2.9	●	○											
	RDET1003M0-GM	10	3.18	5	4.4		○	○										
	RDET10T3M0-GM	10	3.97	5	4.4	●	●	●	○			○			○			
	RDET1204M0-GM	12	4.76	6	4.4	○	●	○							●			
	RDET1604M0-GM	16	4.76	8	5.5	○	●	○	○						○			
	RDEW0501M0	5	1.51	2.5	2.2	○	●	●	○									
	RDEW0702M0	7	2.38	3.5	2.8	○	●	●	○									●
	RDEW1003M0	10	3.18	5	4.4	●		●										
	RDEW0702M0T	7	2.38	3.5	2.8	○	●	●	○									
	RDEW0803M0T	8	3.18	4	2.9	○	○	○	○									
	RDEW1003M0T	10	3.18	5	4.6	●	●	●						●				
	RDEW10T3M0T	10	3.97	5	4.4	●	●	●	○									
	RDEW1204M0T	12	4.76	6	4.4	●	●	●	●					●				
	RDEW1604M0T	16	4.76	8	5	○	○	○						○				
	RDEW1606M0T	16	6.35	8	5.5			○										
	RDEW12T3M0T-BM	12	3.97	6	4.4	○	●	●										
RDEW1204M0T-BM	12	4.76	6	4.4		●	○	○										
	RDEW1204M0T-PM	12	4.82	6	4.4	○	○	●										
	RDEW1605M0T-PM	16	5.66	8	5.5	○	○	○										



● Stock ○ Available Upon Order

Profile Milling

RD

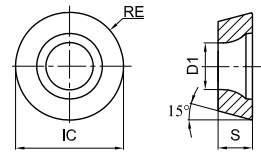



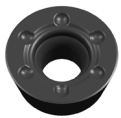



Profile Milling Inserts (Positive)



Ordering Code	Dimension(mm)				Coating Grade										Uncoated	Cermat			
	IC	S	RE	D1	GA4225	GA4230	GA4325	GPM7120	GP4225	GP2115	GM4135	GM2140	GK4125	GK2115			GS4130	GH4115	GN9125
	RDMT10T3M0-GM	10	3.97	5	4.4	●	●	●	●	○	○	●	●						
	RDMT1204M0-GM	12	4.76	6	4.4	●	●	●	●				●	●					
	RDMW1204M0T-BM	12	4.76	6	4.4	●	●	●	●	●			●	●					
	RDMW1605M0T-BM	16	5.56	8	5.5	●	●	●	●										
	RDMW10T3M0T	10	3.97	5	4.4	●	●	●	●				○						○
	RDMW1604M0T	16	4.76	8	5.5	●	●	●	●				○						
	RDMW1204M0T-PM	12	4.76	6	4.4	●		●	●										

● Stock ○ Available Upon Order

RD Series Geometry

Light Cutting for General Material	Medium Cutting For General Material	Heavy Cutting for General Material	Heavy Cutting for General Material
			
BL	GM	None	None/BM/PM
			
Large rake angle design, Sharp edge	Suitable edge width and rake angle design, has good strength and sharpness	Flat design, better edge strength	Flat and chamfer design, better edge strength.

Profile Milling

MPA100

Arbor

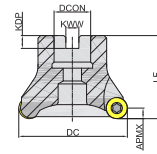

Fig1

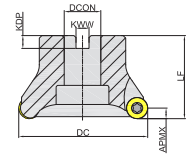

Fig2

Ordering Code	Dia-meter	Teeth	Dimension(mm)					APMX	Suitable for	Coolant	Clamp	Shape	Weight (KG)	Stock
			DC	DCON	LF	KWW	KDP							
MPA100040R05A16RD08	40	5	40	16	40	8.4	6.3	4	RD**0803	×	×	Fig1	0.21	●
MPA100050R04A22RD10	50	4	50	22	50	10.4	6.3	5	RD**10T3	×	✓	Fig1	0.32	●
MPA100050R04A22RD12	50	4	50	22	50	10.4	6.3	6	RD**1204	×	✓	Fig1	0.30	●
MPA100050R05A22RD12	50	5	50	22	50	10.4	6.3	6	RD**1204	×	✓	Fig1	0.32	●
MPA100063R04A22RD16	63	4	63	22	50	10.4	6.3	8	RD**1604	×	×	Fig1	0.52	●
MPA100063R05A22RD12	63	5	63	22	50	10.4	6.3	6	RD**1204	×	✓	Fig1	0.50	●
MPA100080R05A27RD16	80	5	80	27	50	12.4	7	8	RD**1604	×	×	Fig1	0.86	●
MPA100100R06B32RD16	100	6	100	32	50	14.4	8	8	RD**1604	×	×	Fig2	1.13	●
MPA100125R07B40RD16	125	7	125	40	63	16.4	9	8	RD**1604	×	×	Fig2	2.37	●

● Stock ○ Available Upon Order

MPA100

Cylindrical Straight Type

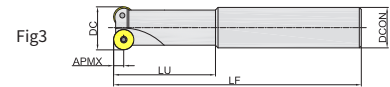
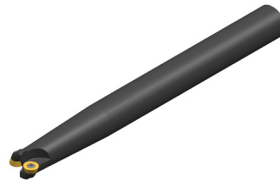

Fig3

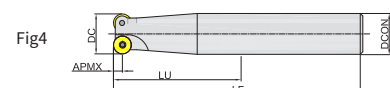

Fig4

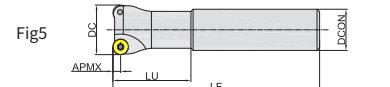

Fig5

Ordering Code	Dia-meter	Teeth	Dimension(mm)				APMX	Suitable for	Coolant	Clamp	Shape	Weight (KG)	Stock
			DC	DCON	LF	LU							
MPA100010R02P16RD05	10	2	10	16	120	40	2.5	RD**0501	×	×	Fig3	0.13	●
MPA100012R02P16RD05	12	2	12	16	120	40	2.5	RD**0501	×	×	Fig3	0.14	●
MPA100016R02P16RD07	16	2	16	16	160	50	3.5	RD**0702	×	×	Fig4	0.23	●
MPA100017R02P16RD08	17	2	17	16	160	50	4	RD**0803	×	×	Fig5	0.23	●
MPA100020R02P20RD08	20	2	20	20	160	50	4	RD**0803	×	×	Fig3	0.35	●
MPA100020R02P20RD10	20	2	20	20	160	50	5	RD**10T3	×	✓	Fig4	0.34	●
MPA100025R02P20RD10	25	2	25	20	160	50	5	RD**10T3	×	✓	Fig5	0.37	●
MPA100032R02P32RD12	32	2	32	32	200	60	6	RD**1204	×	✓	Fig4	1.13	●
MPA100032R02P32RD16	32	3	32	32	200	65	8	RD**1604	×	×	Fig3	1.08	●
MPA100032R03P32RD12S	32	3	32	32	160	50	6	RD**1204	×	✓	Fig3	0.89	●
MPA100032R03P32RD12	32	3	32	32	200	60	6	RD**1204	×	✓	Fig4	1.13	●
MPA100035R02P32RD16	35	2	35	32	200	65	8	RD**1604	×	×	Fig5	1.09	●





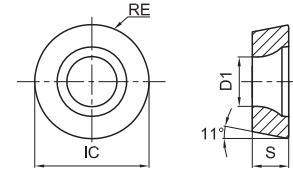

● Stock ○ Available Upon Order

Profile Milling

RP

Profile Milling Inserts (Positive)



Ordering Code	Dimension(mm)				Coating Grade										Uncoated	Cemnet			
	IC	S	RE	D1	GA4225	GA4230	GA4325	GPM7120	GP4225	GP2115	GM4135	GM2140	GK4125	GK2115			GS4130	GH4115	GN9125
	RPET1003M0-GL	10	3.18	5	4.4	○	○												
	RPET1204M0-GL	12	4.76	6	4.4	○	○												
	RPET1003M0T-GM	10	3.18	5	4.4	○	○												
	RPET1204M0-GM	12	4.76	6	4.4	●	○	●											
	RPET08T2M0-GM	8	2.78	4	2.9	●	●	●	●						●				
	RPET1204M0T-GM	12	4.76	6	4.4	●	●	○											
	RPET1606M0T-GM	16	6.35	8	5.5	○	○		○						●				
	RPET1606M0T-GH	16	6.35	8	5.5	○	○	○											
	RPET1606M0-SM	16	6.35	8	5.5				○		●			●					
	RPEW1003M0	10	3.18	5	4.4	○	○	○											
	RPEW10T3M0	10	3.97	5	4.4	○	○	○											
	RPEW08T2M0	8	2.78	4	2.9	○		○											
	RPEW1003M0T	10	3.18	5	4.4	●	●	●											
	RPEW1204M0T	12	4.76	6	4.4	○	○												





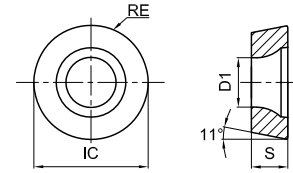

● Stock ○ Available Upon Order

Profile Milling

RP









Profile Milling Inserts (Positive)











Ordering Code	Dimension(mm)				Coating Grade												Uncoated	Cermet
	IC	S	RE	D1	GA4225	GA4230	GA4325	GPM7120	GP4225	GP2115	GM4135	GM2140	GK4125	GK2115	GS4130	GH4115		
 RPMT10T3M0-GM	10	3.97	5	4.4	●	●	●	●	●	●	●	●	●	●	●	○	○	○
 RPMT1003M0T-GM	10	3.18	5	4.4	●	●	●	○	○	○	○	○	○	○	○	○	○	○
 RPMT1204M0-GM	12	4.76	6	4.4	●	●	●	●	●	○	○	○	○	○	○	○	○	○
 RPMT1204M0T-KM	12	4.76	6	4.4	○	○	○	○	○	○	○	○	○	○	○	○	○	○
 RPMW1003M0T	10	3.18	5	4.4	●	●	●	●	●	○	○	○	○	○	○	○	○	○
 RPMW1204M0T	12	4.76	6	4.4	●	●	●	●	●	○	○	○	○	○	○	○	○	○

● Stock ○ Available Upon Order

RP Series Geometry

Light Cutting for General Material	Medium Cutting For General Material	Medium Cutting For General Material	Medium Machining of Nonferrous Metal
			
GL	GM	GM	SM
			
Big rake angle, sharper edge.	Design with suitable rake angle width, has good strength and sharpness.	Design with suitable rake angle width. Combine sharpness with strength.	Suitable edge width and rake design, has good strength and sharpness.

Heavy Cutting for Stainless Steel	Heavy Cutting For General Material	Heavy Cutting for General Material	Heavy Cutting for General Material
			
KM	GH	None	None
			
Large rake angle design, Sharp edge.	Small rake angle, high edge strength.	Flat design, Combine sharpness with strength.	high edge strength.

Profile Milling

MPB100

Arbor

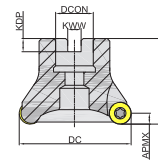

Fig1

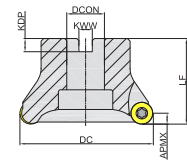

Fig2

Ordering Code	Dia-meter	Teeth	Dimension(mm)					APMX	Suitable for	Coolant	Clamp	Shape	Weight (KG)	Stock
			DC	DCON	LF	KWW	KDP							
MPB100040R04A16RP10	40	4	40	16	40	8.4	6.3	5	RP**1003	×	✓	Fig1	0.16	●
MPB100040R05A16RP08	40	5	40	16	40	8.4	6.3	4	RP**08T2	×	×	Fig1	0.19	●
MPB100050R04A22RP10	50	4	50	22	50	10.4	6.3	5	RP**1003	×	✓	Fig1	0.33	●
MPB100050R04A22RP12	50	4	50	22	50	10.4	6.3	6	RP**1204	×	✓	Fig1	0.32	●
MPB100063R04A22RP16	63	4	63	22	40	10.4	6.3	8	RP**1606	×	×	Fig1	0.33	●
MPB100063R05A22RP12	63	5	63	22	50	10.4	6.3	6	RP**1204	×	✓	Fig1	0.51	●
MPB100063R06A22RP12	63	6	63	22	50	10.4	6.3	6	RP**1204	×	✓	Fig1	0.47	●
MPB100080R06A27RP16	80	6	80	27	50	12.4	7	8	RP**1606	×	×	Fig1	0.83	●
MPB100100R07B32RP16	100	7	100	32	50	14.4	8	8	RP**1606	×	×	Fig2	1.18	●
MPB100125R08B40RP16	125	8	125	40	63	16.4	9	8	RP**1606	×	×	Fig2	2.29	●

● Stock ○ Available Upon Order

MPB100

Cylindrical Straight Type

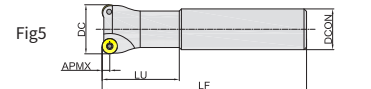
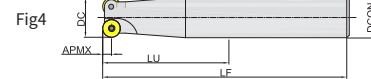
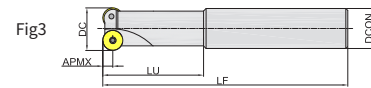

Ordering Code	Dia-meter	Teeth	Dimension(mm)				APMX	Suitable for	Coolant	Clamp	Shape	Weight (KG)	Stock
			DC	DCON	LF	LU							
MPB100016R02P16RP08S	16	2	16	16	120	40	4	RP**08T2	×	×	Fig3	0.16	●
MPB100016R02P16RP08	16	2	16	16	160	50	4	RP**08T2	×	×	Fig3	0.22	●
MPB100020R02P20RP08	20	2	20	20	160	50	4	RP**08T2	×	×	Fig3	0.35	●
MPB100020R02P20RP10	20	2	20	20	160	50	5	RP**1003	×	✓	Fig4	0.35	●
MPB100025R02P20RP10	25	2	25	20	160	50	5	RP**1003	×	✓	Fig5	0.37	●
MPB100025R02P20RP10L	25	2	25	20	200	50	5	RP**1003	×	✓	Fig5	0.47	●
MPB100025R02P25RP12	25	2	25	25	160	50	6	RP**1204	×	✓	Fig3	0.51	●
MPB100025R03P25RP08	25	3	25	25	160	50	4	RP**08T2	×	×	Fig3	0.55	●
MPB100032R02P25RP12	32	2	32	25	160	50	6	RP**1204	×	✓	Fig5	0.57	●
MPB100032R02P25RP12L	32	2	32	25	200	60	6	RP**1204	×	✓	Fig5	0.73	●
MPB100032R03P25RP12	32	3	32	25	160	50	6	RP**1204	×	✓	Fig5	0.56	●
MPB100040R02P32RP16	40	2	40	32	200	65	8	RP**1606	×	×	Fig5	1.15	●







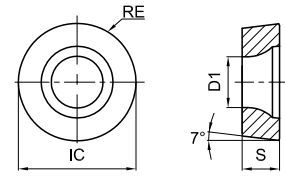

● Stock ○ Available Upon Order

Profile Milling

RC

Profile Milling Inserts (Positive)



Ordering Code	Dimension(mm)				Coating Grade												Uncoated	Cement	
	IC	S	RE	D1	GA4225	GA4230	GA4325	GPM7120	GP4225	GP2115	GM4135	GM2140	GK4125	GK2115	GS4130	GH4115			GN9125
 RCET10T3M0-EM	10	3.97	5	4.4	●	○	●												○
 RCET1204M0-EM	12	4.76	6	4	●	●	○					●		●					
 RCET1606M0-EM	16	6.35	8	5.5	○	●	○				○	○		○					
 RCET2006M0-EM	20	6.35	10	6.5		●	●							●					
 RCET1204M0T-EH	12	4.76	6	4		○	○												
 RCET1606M0T-EH	16	6.35	8	5.5		●	○				○	●							
 RCET2006M0T-EH	20	6.35	10	6.5		●	○												
 RCET1204M0-MM	12	4.76	6	4	●	●	●				○								○

● Stock ○ Available Upon Order

Profile Milling

RC

Profile Milling Inserts (Positive)

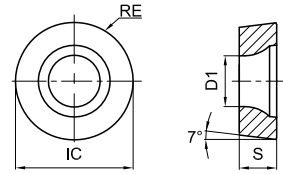











Ordering Code	Dimension(mm)				Coating Grade												Uncoated	Cermat
	IC	S	RE	D1	GA4225	GA4230	GA4325	GPM7120	GP4225	GP2115	GM4135	GM2140	GK4125	GK2115	GS4130	GH4115		
RCMT1606M0T-KM	16	6.35	8	5.5							●							

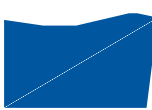

● Stock ○ Available Upon Order

RC Series Geometry

Medium Cutting For General Material	Medium Cutting For General Material	Medium Cutting For General Material	Heavy Cutting for Stainless Steel	Heavy Cutting for General Material
				
EM	EM	MM	KM	EH
				
In general circumstances, high stability machining is realized.	In general circumstances, high stability machining is realized.	Double rake angle design, Combine good sharpness with strength.	Chamfer design, higher edge strength.	Small rake angle and chamfer design, higher edge strength.

Profile Milling

MPC100

Arbor

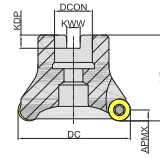

Fig1

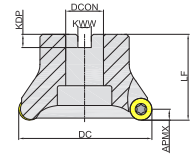

Fig2

Ordering Code	Dia-meter	Teeth	Dimension(mm)				APMX	Suitable for	Coolant	Shape	Weight (KG)	Stock
			DC	DCON	LF	KWW						
MPC100050R04A22RC12	50	4	50	22	50	10.4	6.3	6	RC**1204	×	Fig1	0.31 ●
MPC100050R05A22RC12	50	5	50	22	50	10.4	6.3	6	RC**1204	×	Fig1	0.32 ●
MPC100063R04A22RC12	63	4	63	22	50	10.4	6.3	6	RC**1204	×	Fig1	0.54 ●
MPC100063R04A22RC16	63	4	63	22	50	10.4	6.3	8	RC**1606	×	Fig1	0.43 ●
MPC100063R05A22RC12	63	5	63	22	50	10.4	6.3	6	RC**1204	×	Fig1	0.50 ●
MPC100063R05A22RC16	63	5	63	22	50	10.4	6.3	8	RC**1606	×	Fig1	0.45 ●
MPC100063R06A22RC12	63	6	63	22	50	10.4	6.3	6	RC**1204	×	Fig1	0.51 ●
MPC100080R05A27RC16	80	5	80	27	50	12.4	7	8	RC**1606	×	Fig1	0.80 ●
MPC100080R06A27RC12	80	6	80	27	50	12.4	7	6	RC**1204	×	Fig1	0.87 ●
MPC100080R06A27RC16	80	6	80	27	50	12.4	7	8	RC**1606	×	Fig1	0.78 ●
MPC100100R06B32RC16	100	6	100	32	50	14.4	8	8	RC**1606	×	Fig2	1.11 ●
MPC100100R06B32RC20	100	6	100	32	50	14.4	8	10	RC**2006	×	Fig2	1.06 ●
MPC100125R07B40RC20	125	7	125	40	63	16.4	9	10	RC**2006	×	Fig2	2.35 ●
MPC100160R08B40RC20	160	8	160	40	63	16.4	9	10	RC**2006	×	Fig2	4.49 ●

● Stock ○ Available Upon Order

MPC100

Cylindrical Straight Type

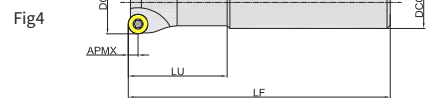
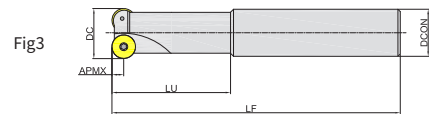

Ordering Code	Dia-meter	Teeth	Dimension(mm)				APMX	Suitable for	Coolant	Shape	Weight (KG)	Stock
			DC	DCON	LF	LU						
MPC100020R02P20RC10	20	2	20	20	110	60	5	RC**10T3	×	Fig3	0.23 ●	
MPC100025R02P20RC10	25	2	25	20	160	50	5	RC**10T3	×	Fig4	0.36 ●	
MPC100032R02P25RC12	32	2	32	25	200	50	6	RC**1204	×	Fig4	0.72 ●	
MPC100040R03P32RC12	40	3	40	32	200	50	6	RC**1204	×	Fig4	1.18 ●	

● Stock ○ Available Upon Order

Spare Parts

Part Name		Clamp Screw	Clamp	Inserts Screw	Recommended Torque	Insert Screw Wrench	
Inserts	Shape						
	Ordering Code	—	—	SI60M020037-02806S	0.6N·m	TT06PQ	—
RD**07	Ordering Code	—	—	SI60M025050-03509S	1.0N·m	TT07PQ	—
RD**08 RP**08	Ordering Code	—	—	SI60M025065-03509S	1.0N·m	TT07PQ	—
RD**10 RP**10	Ordering Code	SI60M035100-05510S	CAX01RQ	SI60M040089-05313S	3.5N·m	TT15PQ	—
RC**10	Ordering Code	—	—	SI60M040089-05313S	3.5N·m	TT15PQ	—
RD**12 RP**12	Ordering Code	SI60M035120-05314S	CAX02RQ	SI60M040089-05313S	3.5N·m	TT15PQ	—
RC**12	Ordering Code	—	—	SI60M035080-05314S	3.0N·m	TT15PQ	—
RD**16 RP**16 RC**16	Ordering Code	—	—	SI60M050108-07209S	5.0N·m	TT20PQ	TT20TQ
RC**20	Ordering Code	—	—	SI60M060160-08509S	7.5N·m	—	TT25TQ

Recommended Cutting Data

Workpiece	Hardness	Grade	Cutting Speed Vc(m/min)	Specif-ication	Feed Rate/Edges fz(mm)			
					Light Cutting(L)	Medium Cutting(M)	Heavy Cutting(H)	
P	Soft Steel	≤ HB180	GA4325 GPM7120	180 (140-220)	05	0.08 (0.05-0.15)	0.1 (0.08-0.15)	0.12 (0.08-0.2)
					07 08	0.08 (0.05-0.15)	0.12 (0.08-0.18)	0.15 (0.10-0.25)
					10 12	0.15 (0.1-0.25)	0.2 (0.15-0.3)	0.25 (0.2-0.35)
					16	0.18 (0.1-0.25)	0.25 (0.15-0.35)	0.3 (0.2-0.45)
					20	0.2 (0.12-0.25)	0.3 (0.15-0.4)	0.35 (0.2-0.45)
	Carbon Steel, Alloy Steel	HB180-350	GPM7120 GA4325 GP2115	160 (120-200)	05	0.08 (0.05-0.15)	0.1 (0.08-0.15)	0.12 (0.08-0.2)
					07 08	0.08 (0.05-0.15)	0.12 (0.08-0.18)	0.15 (0.1-0.25)
					10 12	0.15 (0.1-0.25)	0.2 (0.15-0.3)	0.25 (0.2-0.35)
					16	0.18 (0.1-0.25)	0.25 (0.15-0.35)	0.3 (0.2-0.45)
					20	0.2 (0.12-0.25)	0.3 (0.15-0.4)	0.35 (0.2-0.45)
	Pre-hardened Steel	HRC35-45	GPM7120 GA4325 GP2115	120 (80-160)	05	0.08 (0.05-0.15)	0.1 (0.08-0.15)	0.12 (0.08-0.2)
					07 08	0.08 (0.05-0.15)	0.12 (0.08-0.18)	0.15 (0.1-0.25)
					10 12	0.15 (0.1-0.25)	0.2 (0.15-0.3)	0.25 (0.2-0.35)
					16	0.18 (0.1-0.25)	0.25 (0.15-0.35)	0.3 (0.2-0.45)
					20	0.2 (0.12-0.25)	0.3 (0.15-0.4)	0.35 (0.2-0.45)
M	Stainless (Ferrite, Martensite)	≤ HB270	GM2140 GM4135	140 (100-180)	05	0.08 (0.05-0.15)	0.1 (0.08-0.15)	0.12 (0.08-0.2)
					07 08	0.08 (0.05-0.15)	0.12 (0.08-0.18)	0.15 (0.1-0.25)
					10 12	0.15 (0.1-0.25)	0.2 (0.15-0.3)	0.25 (0.2-0.35)
					16	0.18 (0.1-0.25)	0.25 (0.15-0.35)	0.35 (0.2-0.45)
					20	0.2 (0.12-0.25)	0.3 (0.15-0.4)	0.35 (0.2-0.45)
	Stainless (Austenite, Diphasic)	≤ HB270	GM2140 GM4135	120 (80-160)	05	0.08 (0.05-0.15)	0.1 (0.08-0.15)	0.12 (0.08-0.2)
					07 08	0.08 (0.05-0.15)	0.12 (0.08-0.18)	0.15 (0.1-0.25)
					10 12	0.15 (0.1-0.25)	0.2 (0.15-0.3)	0.25 (0.2-0.35)
					16	0.18 (0.1-0.25)	0.25 (0.15-0.35)	0.35 (0.2-0.45)
					20	0.2 (0.12-0.25)	0.3 (0.15-0.4)	0.35 (0.2-0.45)

Recommended Cutting Data

Workpiece	Hardness	Grade	Cutting Speed Vc(m/min)	Specif- ication	Feed Rate/Edges fz(mm)			
					Light Cutting(L)	Medium Cutting(M)	Heavy Cutting(H)	
K	Grey Cast Iron	≤ HB280	GK2115 GK4125	180 (150-220)	05	0.08 (0.05-0.15)	0.15 (0.08-0.15)	0.12 (0.08-0.2)
					07 08	0.08 (0.05-0.15)	0.12 (0.08-0.18)	0.15 (0.1-0.25)
					10 12	0.15 (0.1-0.25)	0.2 (0.15-0.3)	0.25 (0.2-0.35)
					16	0.18 (0.1-0.25)	0.25 (0.15-0.35)	0.3 (0.2-0.45)
					20	0.2 (0.12-0.25)	0.3 (0.15-0.4)	0.35 (0.2-0.45)
	Nodular Cast Iron, Vermicular Graphite Cast Iron	≤ HB350	GK2115 GK4125	120 (100-180)	05	0.08 (0.05-0.15)	0.15 (0.08-0.15)	0.12 (0.08-0.2)
					07 08	0.08 (0.05-0.15)	0.12 (0.08-0.18)	0.15 (0.1-0.25)
					10 12	0.15 (0.1-0.25)	0.2 (0.15-0.3)	0.25 (0.2-0.35)
					16	0.18 (0.1-0.25)	0.25 (0.15-0.35)	0.3 (0.2-0.45)
					20	0.2 (0.12-0.25)	0.3 (0.15-0.4)	0.35 (0.2-0.45)
S	Heat-resistant Alloy and Titanium Alloy	HRC30-45	GS4130	40 (30-60)	16	0.08 (0.05-0.15)	0.12 (0.08-0.15)	—

- $RPM(\min-1) = (1000 \times \text{cutting speed}) / (3.14 \times \text{cutter diameter})$
- $\text{Machine feed}(\text{mm}/\text{min}) = \text{feed per tooth} \times \text{flute No.} \times \text{RPM}$
- Class S material are matched with SM Geometry

RD/RP/RC Recommend Cutting Feed and Cutting Depth

Specification	Working Conditions	Ap(mm)								
		0.1	0.5	1	1.5	2	2.5	3	4	5
05	Medium Maching (M)	0.35 (0.22-0.63)	0.17 (0.08-0.26)	0.12 (0.06-0.21)	0.1 (0.05-0.17)	—	—	—	—	—
	Heavy Maching (H)	0.45 (0.29-0.95)	0.2 (0.12-0.38)	0.16 (0.09-0.28)	0.14 (0.07-0.25)	—	—	—	—	—
07 08	Medium Maching (M)	0.59 (0.23-0.9)	0.27 (0.1-0.41)	0.2 (0.08-0.3)	0.17 (0.06-0.26)	0.15 (0.03-0.23)	—	—	—	—
	Heavy Maching (H)	0.68 (0.32-1.13)	0.31 (0.14-0.52)	0.23 (0.11-0.38)	0.19 (0.09-0.32)	0.17 (0.08-0.29)	—	—	—	—
10	Light Maching (L)	0.75 (0.25-0.9)	0.34 (0.11-0.41)	0.25 (0.08-0.3)	0.21 (0.07-0.25)	0.19 (0.06-0.23)	0.17 (0.05-0.21)	—	—	—
	Medium Maching (M)	0.9 (0.25-1.26)	0.41 (0.11-0.57)	0.30 (0.08-0.42)	0.25 (0.07-0.35)	0.23 (0.06-0.31)	0.21 (0.05-0.28)	—	—	—
	Heavy Maching (H)	1.01 (0.35-1.51)	0.46 (0.16-0.69)	0.33 (0.12-0.5)	0.28 (0.1-0.42)	0.25 (0.09-0.38)	0.23 (0.08-0.35)	—	—	—
12	Light Maching (L)	0.83 (0.28-1.1)	0.38 (0.13-0.5)	0.27 (0.09-0.36)	0.23 (0.08-0.3)	0.2 (0.07-0.27)	0.18 (0.06-0.25)	0.17 (0.06-0.23)	—	—
	Medium Maching (M)	0.99 (0.28-1.38)	0.45 (0.13-0.63)	0.33 (0.09-0.45)	0.27 (0.08-0.38)	0.24 (0.07-0.34)	0.22 (0.06-0.31)	0.21 (0.06-0.29)	—	—
	Heavy Maching (H)	1.1 (0.39-1.65)	0.5 (0.18-0.75)	0.36 (0.13-0.54)	0.3 (0.11-0.45)	0.27 (0.09-0.4)	0.25 (0.08-0.37)	0.23 (0.08-0.35)	—	—
16	Light Maching (L)	1.14 (0.32-1.59)	0.52 (0.14-0.72)	0.37 (0.1-0.52)	0.31 (0.09-0.43)	0.27 (0.08-0.38)	0.25 (0.07-0.35)	0.23 (0.06-0.32)	0.21 (0.06-0.29)	—
	Medium Maching (M)	1.27 (0.32-1.9)	0.57 (0.14-0.86)	0.41 (0.1-0.62)	0.34 (0.09-0.51)	0.30 (0.08-0.45)	0.28 (0.07-0.41)	0.26 (0.06-0.38)	0.23 (0.06-0.35)	—
	Heavy Maching (H)	1.59 (0.44-2.54)	0.72 (0.20-1.15)	0.52 (0.14-0.83)	0.43 (0.12-0.69)	0.38 (0.11-0.6)	0.35 (0.1-0.54)	0.32 (0.09-0.51)	0.29 (0.08-0.46)	—
20	Heavy Maching (H)	2.14 (0.59-3.49)	0.97 (0.25-1.60)	0.71 (0.18-1.17)	0.58 (0.15-0.96)	0.5 (0.14-0.81)	0.46 (0.13-0.73)	0.42 (0.12-0.68)	0.38 (0.11-0.61)	0.34 (0.1-0.55)

Note: In application of round inserts, in general, the ap should be less than 25% of IC. Otherwise, SNUE/SEET series of inserts with Kr=45 are recommended.

Profile Milling

QTD

Ballnose Milling Insert

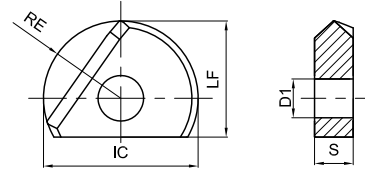

Ordering Code	Dimension(mm)					Coating Grade										Uncoated	Cermat					
	RE	IC	LF	D1	S	GA4225	GA4230	GA4325	GPM7120	GP4225	GP2115	GM4135	GM2140	GK4125	GK2115			GS4130	GH4115	GN9125	GP01TM	
QTD1203	6	12	10	3.5	3	●														●		
QTD1604	8	16	12	4	4	●															●	
QTD2005	10	20	15	5	5	●																●
QTD2506	12.5	25	18.5	6	6	●																●
QTD3007	15	30	22.5	8	7	●																●
QTD3207	16	32	23.5	8	7	●																●



● Stock ○ Available Upon Order

QTD-S-T

Curved Edge in Ballnose Milling Insert

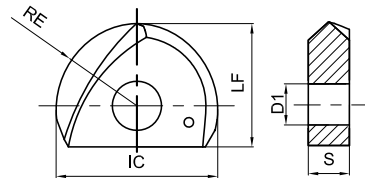

Ordering Code	Dimension(mm)					Coating Grade										Uncoated	Cermat					
	RE	IC	LF	D1	S	GA4225	GA4230	GA4325	GPM7120	GP4225	GP2115	GM4135	GM2140	GK4125	GK2115			GS4130	GH4115	GN9125	GP01TM	
QTD1203-S-T	6	12	10	3.5	3																	●
QTD1604-S-T	8	16	12	4	4																	●
QTD2005-S-T	10	20	15	5	5																	●
QTD2506-S-T	12.5	25	18.5	6	6																	●
QTD3007-S-T	15	30	22.5	8	7																	●
QTD3207-S-T	16	32	23.5	8	7																	●



● Stock ○ Available Upon Order

Profile Milling

MBA100

Cylindrical Straight Type

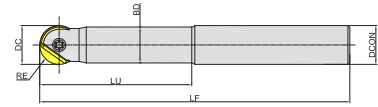

Fig1

Ordering Code	Dia-meter	Teeth	Dimension(mm)						Suitable for	Coolant	Shape	Weight (KG)	Stock
			DC	DCON	BD	LF	LU	RE					
MBA100012R01P12QT12S	12	1	12	12	10.5	90	30	6	QTD1203	×	Fig1	0.07	●
MBA100012R01P12QT12	12	1	12	12	10.5	120	60	6	QTD1203	×	Fig1	0.09	●
MBA100012R01P12QT12L	12	1	12	12	10.5	150	90	6	QTD1203	×	Fig1	0.11	●
MBA100016R01P16QT16S	16	1	16	16	14.5	100	35	8	QTD1604	×	Fig1	0.14	●
MBA100016R01P16QT16	16	1	16	16	14.5	135	70	8	QTD1604	×	Fig1	0.18	●
MBA100016R01P16QT16L	16	1	16	16	14.5	170	100	8	QTD1604	×	Fig1	0.23	●
MBA100020R01P20QT20S	20	1	20	20	18.5	110	45	10	QTD2005	×	Fig1	0.23	●
MBA100020R01P20QT20	20	1	20	20	18.5	160	80	10	QTD2005	×	Fig1	0.34	●
MBA100020R01P20QT20L	20	1	20	20	18.5	210	135	10	QTD2005	×	Fig1	0.44	●
MBA100025R01P25QT25S	25	1	25	25	23	125	50	12.5	QTD2506	×	Fig1	0.41	●
MBA100025R01P25QT25	25	1	25	25	23	180	100	12.5	QTD2506	×	Fig1	0.59	●
MBA100025R01P25QT25L	25	1	25	25	23	235	150	12.5	QTD2506	×	Fig1	0.77	●
MBA100030R01P32QT30S	30/32	1	30/32	32	28.5	150	60	15/16	QTD3007 QTD3207	×	Fig1	0.78	●
MBA100030R01P32QT30	30/32	1	30/32	32	28.5	200	120	15/16	QTD3007 QTD3207	×	Fig1	1.02	●
MBA100030R01P32QT30L	30/32	1	30/32	32	28.5	270	180	15/16	QTD3007 QTD3207	×	Fig1	1.38	●

● Stock ○ Available Upon Order

Profile Milling

MBA100

Taper Joint Cylindrical Straight Shank

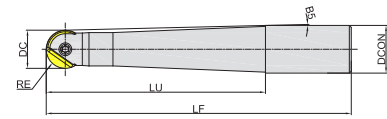

Fig2

Ordering Code	Dia-meter	Teeth	Dimension(mm)						Suitable for	Coolant	Shape	Weight (KG)	Stock
			DC	DCON	LF	LU	RE	B5					
MBA100012R01P16TQT12L	12	1	12	16	145	85	6	1.4°	QTD1203	×	Fig2	0.17	●
MBA100016R01P20TQT16L	16	1	16	20	166	100	8	1.2°	QTD1604	×	Fig2	0.30	●
MBA100020R01P25TQT20L	20	1	20	25	191	115	10	1.3°	QTD2005	×	Fig2	0.53	●
MBA100025R01P32TQT25L	25	1	25	32	215	135	12.5	1.6°	QTD2506	×	Fig2	0.90	○
MBA100030R01P32TQT30L	30/32	1	30/32	32	240	160	15/16	0.3°	QTD3007 QTD3207	×	Fig2	1.19	●

● Stock ○ Available Upon Order

Profile Milling

MBA100

Replaceable Tool Head

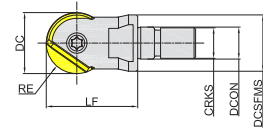



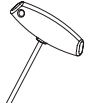

Fig3

Ordering Code	Dia-meter	Teeth	Dimension(mm)						Suitable for	Coolant	Shape	Weight (KG)	Stock
			DC	DCSFMS	DCON	LF	RE	CRKS					
MBA100012R01M06QT12	12	1	12	11.5	6.5	20	6	M6	QTD1203	×	Fig3	0.01	●
MBA100016R01M08QT16	16	1	16	15	8.5	23	8	M8	QTD1604	×	Fig3	0.02	●
MBA100020R01M10QT20	20	1	20	18.5	10.5	30	10	M10	QTD2005	×	Fig3	0.05	●
MBA100025R01M12QT25	25	1	25	24	12.5	35	12.5	M12	QTD2506	×	Fig3	0.08	●
MBA100030R01M16QT30	30/32	1	30/32	29	17	43	15/16	M16	QTD3007 QTD3207	×	Fig3	0.15	●

● Stock ○ Available Upon Order

Spare Parts

Part Name		Inserts Screw	Recommended Torque	Insert Screw Wrench	
Inserts	Shape				
	Ordering Code	SBM035095Q	2.0N·m	TT10KQ	—
Ordering Code	SBM040135Q	3.0N·m	TT15KQ	—	
Ordering Code	SBM050165Q	4.0N·m	TT20KQ	—	
Ordering Code	SBM060200Q	5.0N·m	TT20KQ	—	
Ordering Code	SBM080250Q	6.0N·m	—	TT30TQ	
Ordering Code	SBM080250Q	6.0N·m	—	TT30TQ	

Recommended Cutting Data

Workpiece	Hardness	Grade	Cutting Speed Vc(m/min)	Ap (mm)	Ae (mm)	Feed Rate/Edges fz(mm)						
						Diameter: ΦD(mm)						
						12	16	20	25	30	32	
P	Soft Steel	≤ HB180	GA4225	400 (360-440)	0.3-0.6	D/40	0.3-0.6	0.3-0.6	0.5-0.8	0.5-0.8	0.7-1.0	0.7-1.0
	Carbon Steel, Alloy Steel	HB180-350	GA4225	350 (310-390)	0.3-0.6	D/40	0.3-0.6	0.3-0.6	0.5-0.8	0.5-0.8	0.7-1.0	0.7-1.0
	Pre-harden Steel	HRC35-45	GA4225	350 (310-390)	0.3-0.6	D/40	0.3-0.6	0.3-0.6	0.5-0.8	0.5-0.8	0.7-1.0	0.7-1.0
K	Grey Cast Iron	≤ HB280	GH4115	450 (410-190)	0.3-0.6	D/50	0.2-0.5	0.2-0.5	0.4-0.7	0.4-0.7	0.7-1.0	0.7-1.0
	Nodular Cast Iron, Vermicular Graphite Cast Iron	≤ HB350	GH4115	350 (310-390)	0.2-0.5	D/40	0.1-0.4	0.1-0.4	0.3-0.6	0.3-0.6	0.5-0.8	0.5-0.8
H	Hardened Steel	HRC48-55	GH4115	150 (110-190)	0.1-0.3	D/50	0.1-0.4	0.1-0.4	0.2-0.5	0.2-0.5	0.2-0.5	0.2-0.5

Insert Installation Procedure:

- ① Using an air gun to clean the insert locating surface
- ② Using a wrench to lock the screw, and do not press the plug-in during the locking.
- ③ Using a wrench to lock the screw, and do not press the inserts during the locking.
- ④ End of setup.

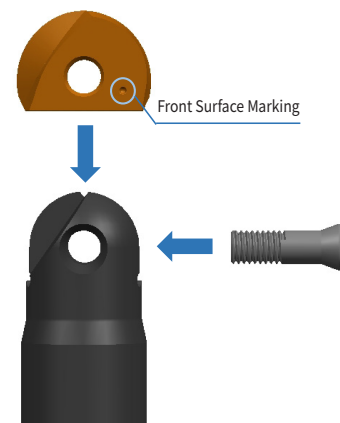



High Feed Milling

UD/UP

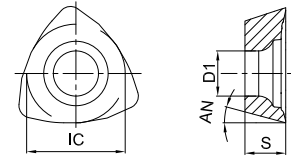

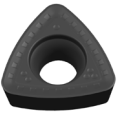
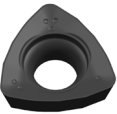

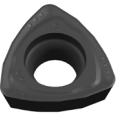
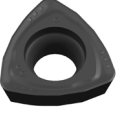
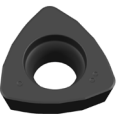



3 Edges High Feed Milling

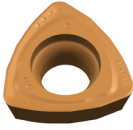

Ordering Code	Dimension(mm)				Coating Grade										Uncoated	Cermat		
	IC	S	AN	D1	GA4225	GA4230	GA4325	GPM7120	GP4225	GP2115	GM4135	GM2140	GK4125	GK2115			GS4130	GH4115
 UPET170520-PM	13	5.56	11°	5.5	●	●						○						
 UDET080308-MM	6.8	3.18	15°	2.8	●	●						●					●	
 UDET12T312-MM	9.6	3.97	15°	4.4	●	●											●	
 UDMT080308T-MH	6.8	3.18	15°	2.8	●	●												
 UDMT12T312T-MH	9.6	3.97	15°	4.4	●	●												
 UDMW12T312T	9.6	3.97	15°	4.4	●	●						●						

● Stock ○ Available Upon Order

UD/UP Series Geometry

Medium Cutting of Steel	Medium Cutting of Stainless Steel	Rough Cutting of Stainless Steel	Rough Cutting of General Material
			
PM	MM	MH	None
			
Chamfered cutting edge with rake angle, it is suitable for medium cutting.	Large rake angle makes cutting edge more sharply.	Smaller rake angle makes strong cutting edge.	Flat insert design makes strongest cutting edge.

High Feed Milling

MKA110

Arbor

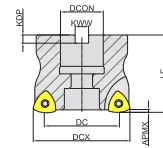
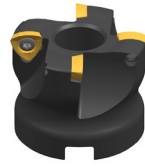

Fig1

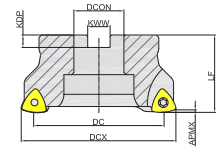

Fig2

Ordering Code	Dia-meter	Teeth	Dimension(mm)						APMX	Suitable for	Coolant	Shape	Weight (KG)	Stock
			DC	DCX	DCON	LF	KWW	KDP						
MKA110040R05A16UD08	40	5	32	40	16	40	8.4	5.6	1	UD**0803	×	Fig1	0.20	●
MKA110050R04A22UD12	50	4	39	50	22	40	10.4	6.3	1.5	UD**12T3	×	Fig1	0.31	●
MKA110050R06A22UD08	50	6	42	50	22	40	10.4	6.3	1	UD**0803	×	Fig1	0.35	●
MKA110063R04A22UP17	63	4	43	63	22	50	10.4	6.3	2	UP**1705	×	Fig1	0.58	●
MKA110063R05A22UD12	63	5	52	63	22	50	10.4	6.3	1.5	UD**12T3	×	Fig1	0.59	●
MKA110063R05A22UP17	63	5	43	63	22	40	10.4	6.3	2	UP**1705	✓	Fig1	0.45	●
MKA110080R05A27UP17	80	5	60	80	27	50	12.4	7	2	UP**1705	×	Fig1	0.94	●
MKA110080R06A27UP17	80	6	60	80	27	50	12.4	7	2	UP**1705	×	Fig1	1.02	●
MKA110100R06B32UP17	100	6	80	100	32	50	14.4	8	2	UP**1705	×	Fig2	1.38	●

● Stock ○ Available Upon Order

MKA110

Cylindrical Straight Type

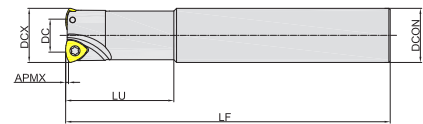

Fig3

Ordering Code	Dia-meter	Teeth	Dimension(mm)						APMX	Suitable for	Coolant	Shape	Weight (KG)	Stock
			DC	DCX	DCON	LF	LU							
MKA110020R02P20UD08S	20	2	12	20	20	120	40	1	UD**0803	×	Fig3	0.26	●	
MKA110020R02P20UD08	20	2	12	20	20	160	50	1	UD**0803	×	Fig3	0.36	●	
MKA110020R02P20UD08L	20	2	12	20	20	200	65	1	UD**0803	×	Fig3	0.45	●	
MKA110025R02P25UD08S	25	2	17	25	20	120	40	1	UD**0803	×	Fig3	0.42	●	
MKA110025R02P25UD08	25	2	17	25	25	160	50	1	UD**0803	×	Fig3	0.57	●	
MKA110025R02P25UD12	25	2	14	25	25	160	50	1.5	UD**12T3	×	Fig3	0.55	●	
MKA110025R03P25UD08	25	3	17	25	25	160	40	1	UD**0803	×	Fig3	0.56	●	
MKA110030R03P32UD12	30	3	19	30	32	200	50	1.5	UD**12T3	×	Fig3	1.11	●	
MKA110032R03P32UD12	32	3	21	32	32	200	50	1.5	UD**12T3	×	Fig3	1.15	●	
MKA110035R03P32UD12	35	3	24	35	32	200	50	1.5	UD**12T3	×	Fig3	1.18	●	
MKA110035R05P32UD08	35	5	27	35	32	200	50	1	UD**0803	×	Fig3	1.20	●	

● Stock ○ Available Upon Order

High Feed Milling

MKA110

Replaceable Tool Head

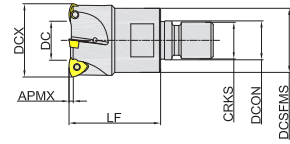

Fig4

Ordering Code	Dia-meter	Teeth	Dimension(mm)							APMX	Suitable for	Coolant	Shape	Weight (KG)	Stock
			DC	DCX	DCSFMS	DCON	LF	CRKS							
MKA110020R02M10UD08	20	2	12	20	18	10.5	30	M10	1	UD**0803	✓	Fig4	0.05	●	
MKA110025R03M12UD08	25	3	17	25	23	12.5	35	M12	1	UD**0803	✓	Fig4	0.10	●	
MKA110032R03M16UD08	32	3	24	32	28	17	40	M16	1	UD**0803	✓	Fig4	0.21	●	
MKA110032R03M16UD12	32	3	21	32	28	17	40	M16	1.5	UD**12T3	✓	Fig4	0.17	●	
MKA110032R04M16UD08	32	4	24	32	28	17	40	M16	1	UD**0803	✓	Fig4	0.20	●	
MKA110035R05M16UD08	35	5	27	35	29	17	40	M16	1	UD**0803	✓	Fig4	0.21	●	

● Stock ○ Available Upon Order

Spare Parts

Part Name		Inserts Screw	Recommended Torque	Insert Screw Wrench	
Inserts	Shape				
	Ordering Code	SI60M025065-03610IS	1.2N·m	TI07PB	—
Ordering Code	SI60M040085-05609IB	3.5N·m	TI15PB	—	
Ordering Code	SI60M050108-07214IB	5.0N·m	TI20PB	TI20TB	

Parameters for Programing

Specification	Approximate Corner Ratio R(mm)	Remains K(mm)
UD**0803	1.8	0.6
UD**12T3	2.6	0.9
UP**1705	3.5	1.0

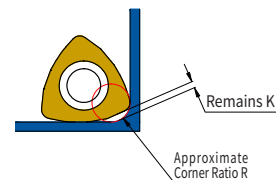

The Relationship of Recommended Feed and Depth of UD/UP Inserts

Feed Rate/Edges fz Specification	Ap(mm)			
	0.5	1	1.5	2
08	0.8 (0.6-1.2)	0.5 (0.4-0.8)	—	—
12	1.5 (1.0-2.0)	1.2 (0.8-1.5)	0.8 (0.6-1.2)	—
17	2 (1.8-2.5)	1.5 (1.0-2.0)	1.2 (0.8-1.5)	0.8 (0.6-1.2)

Recommended Cutting Data



Workpiece	Hardness	Grade	Specification	Ap (mm)	Cutting Speed Vc(m/min)	Feed Rate/Edges fz(mm)			
						Medium Cutting(M)	Heavy Cutting(H)		
P	Soft Steel	≤ HB180	GA4225 GA4230	UD**0803	0.5	180 (140-220)	1.2 (0.8-1.5)	1.5 (1.0-2.0)	
				UD**12T3					0.7
				UP**1705					1
	Carbon Steel, Alloy Steel	HB180-350	GA4225 GA4230 GP2115	UD**0803	0.5	150 (110-190)	1.0 (0.8-1.2)	1.2 (1.0-1.4)	
				UD**12T3					0.7
				UP**1705					1
	Pre-hardened Steel	HRC35-45	GA4230 GA4225 GP2115	UD**0803	0.5	120 (80-160)	1.0 (0.8-1.2)	1.2 (1.0-1.4)	
				UD**12T3					0.7
				UP**1705					1
M	Stainless (Ferrite, Martensite)	≤ HB270	GM2140 GA4230	UD**0803	0.5	120 (80-160)	0.8 (0.6-1.0)	1.0 (0.8-1.2)	
				UD**12T3					0.7
				UP**1705					1
	Stainless (Austenite, Diphasic)	≤ HB270	GM2140	UD**0803	0.5	100 (60-140)	0.6 (0.4-0.8)	0.8 (0.6-1.0)	
				UD**12T3					0.7
				UP**1705					1
K	Grey Cast Iron	≤ HB280	GK2115 GK4125	UD**0803	0.5	180 (110-220)	1.2 (0.8-1.5)	1.5 (1.0-2.0)	
				UD**12T3					0.7
				UP**1705					1
	Nodular Cast Iron, Vermicular Graphite Cast Iron	≤ HB350	GK4125 GK2115	UD**0803	0.5	120 (80-160)	1.2 (0.8-1.5)	1.5 (1.0-2.0)	
				UD**12T3					0.7
				UP**1705					1
S	Heat-resistant Alloy and Titanium Alloy	HRC30-45	GS4130	UD**0803	0.5	40 (30-60)	0.3 (0.15-0.4)	0.4 (0.2-0.6)	
				UD**12T3					0.7
				UP**1705					1

High Feed Milling

SDMT

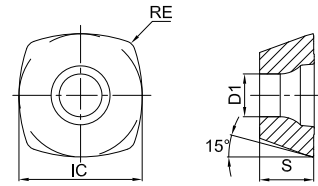
Four-edge High Feed Milling Inserts

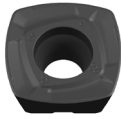

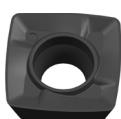





Ordering Code	Dimension(mm)				Coating Grade										Uncoated	Cermat		
	IC	S	D1	RE	GA4225	GA4230	GA4325	GPM7120	GP4225	GP2115	GM4135	GM2140	GK4125	GK2115			GS4130	GH4115
	SDMT120512-GM	12.7	5.56	4.4	1.2	●	●	●	●	●	●	●	●	●	●			
	SDMT150512-GM	15.875	5.56	5.5	1.2	●	●	●					●					
	SDMT120512-GH	12.7	5.56	4.4	1.2	●	●	●	●	●			●					
	SDMT150512-GH	15.875	5.56	5.5	1.2	●	●	●					●					
	★ SDMT09T307-SM	9	3.50	3.5	0.7						●	●			●			
	★ SDMT120512-SM	12.7	5.56	4.4	1.2						●	●			●			

Note:
★ SM geometry only match with MKM113 series cutter.

● Stock ○ Available Upon Order

SDMT Series Geometry

Medium Cutting for General Material	Heavy Cutting for General Material	Medium Cutting of Nonferrous
		
GM	GH	SM
		
<p>Chamfered cutting edge with rake angle, it is suitable for medium.</p>	<p>Cutting force with special rake angle, it is suitable for heavy cutting.</p>	<p>Gradually changing rake angle, it is suitable for medium machining.</p>

High Feed Milling

MKB113

Arbor

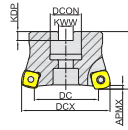
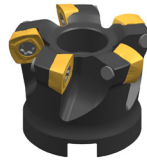

Fig1

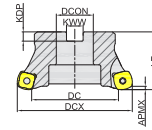

Fig2

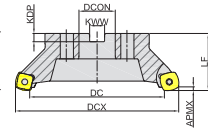

Fig3

Ordering Code	Dia-meter	Teeth	Dimension(mm)						APMX	Suitable for	Coolant	Shape	Weight (KG)	Stock
			DC	DCX	DCON	LF	KWW	KDP						
MKB113050R04A22SD12	50	4	34	50	22	40	10.4	6.3	2	SDMT1205	×	Fig1	0.21	●
MKB113052R05A22SD12	52	4	36	52	22	40	10.4	6.3	2	SDMT1205	×	Fig1	0.23	●
MKB113063R04A22SD12	63	4	47	63	22	40	10.4	6.3	2	SDMT1205	×	Fig1	0.42	●
MKB113063R04A22SD15	63	4	42	63	22	40	10.4	6.3	3	SDMT1505	×	Fig1	0.38	●
MKB113063R05A22SD12	63	5	47	63	22	40	10.4	6.3	2	SDMT1205	×	Fig1	0.42	●
MKB113080R05A27SD12	80	5	64	80	27	50	12.4	7	2	SDMT1205	×	Fig1	1.01	●
MKB113080R05A27SD15	80	5	59	80	27	50	12.4	7	3	SDMT1505	×	Fig1	0.75	●
MKB113080R06A27SD12	80	6	64	80	27	50	12.4	7	2	SDMT1205	×	Fig1	0.98	●
MKB113100R06B32SD12	100	6	84	100	32	50	14.4	8	2	SDMT1205	×	Fig2	1.17	●
MKB113100R06A32SD15	100	6	79	100	32	50	14.4	8	3	SDMT1505	✓	Fig1	1.19	●
MKB113100R06B32SD15	100	6	79	100	32	50	14.4	8	3	SDMT1505	×	Fig2	1.05	●
MKB113100R07B32SD12	100	7	84	100	32	50	14.4	8	2	SDMT1205	×	Fig2	1.17	●
MKB113125R07B40SD15	125	7	104	125	40	63	16.4	9	3	SDMT1505	×	Fig2	2.27	●
MKB113160R09C40SD12	160	9	144	160	40	63	16.4	9	2	SDMT1205	×	Fig3	3.71	●

Note:

★ SDMT1205 Indicates the insert SDMT120512-GM/GH

● Stock ○ Available Upon Order

High Feed Milling

MKB113

Cylindrical Straight Type

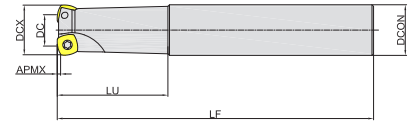

Fig4

Ordering Code	Dia-meter	Teeth	Dimension(mm)					APMX	Suitable for	Coolant	Shape	Weight (KG)	Stock
			DC	DCX	DCON	LF	LU						
MKB113032R02P32SD12S	32	2	16	32	32	160	70	2	SDMT1205	×	Fig4	0.86	●
MKB113032R02P32SD12	32	2	16	32	32	200	70	2	SDMT1205	×	Fig4	1.12	●
MKB113035R03P32SD12	35	3	19	35	32	200	70	2	SDMT1205	×	Fig4	1.12	●
MKB113040R03P32SD12	40	3	24	40	32	200	70	2	SDMT1205	×	Fig4	1.16	●

Note:

★ SDMT1205 Indicates the insert SDMT120512-GM/GH

● Stock ○ Available Upon Order

High Feed Milling

MKB113

Replaceable Tool Head

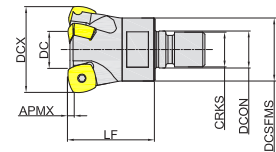

Fig5

Ordering Code	Dia-meter	Teeth	Dimension(mm)						APMX	Suitable for	Coolant	Shape	Weight (KG)	Stock
			DC	DCX	DCSFMS	DCON	LF	CRKS						
MKB113032R02M16SD12	32	2	16	32	28	17	40	M16	2	SDMT1205	✓	Fig5	0.16	●
MKB113032R03M16SD12	32	3	16	32	28	17	40	M16	2	SDMT1205	✓	Fig5	0.16	●
MKB113035R03M16SD12	35	3	19	35	29	17	40	M16	2	SDMT1205	✓	Fig5	0.17	●
MKB113040R03M16SD12	40	3	24	40	29	17	40	M16	2	SDMT1205	✓	Fig5	0.19	●

Note:

★ SDMT1205 Indicates the insert SDMT120512-GM/GH

● Stock ○ Available Upon Order

High Feed Milling

MKM113

Arbor

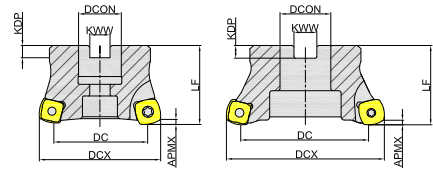

Fig1

Fig2

Ordering Code	Dia-meter	Teeth	Dimension(mm)						APMX	Suitable for	Coolant	Shape	Weight (KG)	Stock
			DC	DCX	DCON	LF	KWW	KDP						
MKM113040R05A16SD09	40	5	25	40	16	40	8.4	5.6	1	SDMT09T307-SM	✓	Fig1	0.17	○
MKM113042R05A22SD09	42	5	27	42	22	40	10.4	6.3	1	SDMT09T307-SM	✓	Fig1	0.16	○
MKM113050R05A22SD12	50	5	27	50	22	40	10.4	6.3	2	SDMT120512-SM	✓	Fig1	0.28	○
MKM113050R06A22SD09	50	6	35	50	22	40	10.4	6.3	1	SDMT09T307-SM	✓	Fig1	0.27	○
MKM113050R07A22SD09	50	7	35	50	22	40	10.4	6.3	1	SDMT09T307-SM	✓	Fig1	0.29	○
MKM113052R05A22SD09	52	5	37	52	22	40	10.4	6.3	1	SDMT09T307-SM	✓	Fig1	0.33	○
MKM113052R05A22SD12	52	5	29	52	22	40	10.4	6.3	2	SDMT120512-SM	✓	Fig1	0.28	○
MKM113052R07A22SD09	52	7	37	52	22	40	10.4	6.3	1	SDMT09T307-SM	✓	Fig1	0.33	○
MKM113063R05A22SD09	63	5	48	63	22	40	10.4	6.3	1	SDMT09T307-SM	✓	Fig1	0.52	○
MKM113063R06A22SD12	63	6	40	63	22	40	10.4	6.3	2	SDMT120512-SM	✓	Fig1	0.47	○
MKM113063R08A22SD09	63	8	48	63	22	40	10.4	6.3	1	SDMT09T307-SM	✓	Fig1	0.50	○
MKM113063R09A22SD09	63	9	48	63	22	40	10.4	6.3	1	SDMT09T307-SM	✓	Fig1	0.52	○
MKM113080R06A27SD12	80	6	56	80	27	50	12.4	7	2	SDMT120512-SM	✓	Fig1	0.99	○
MKM113080R08A27SD12	80	8	56	80	27	50	12.4	7	2	SDMT120512-SM	✓	Fig1	0.99	○
MKM113100R10B32SD12	100	10	75	100	32	50	14.4	8	2	SDMT120512-SM	✓	Fig2	1.60	○
MKM113125R11B40SD12	125	11	100	125	40	63	16.4	9	2	SDMT120512-SM	✓	Fig2	3.32	○

● Stock ○ Available Upon Order

High Feed Milling

MKM113

Cylindrical Straight Type

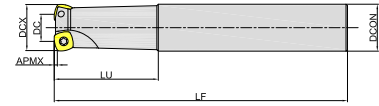

Fig3

Ordering Code	Dia-meter	Teeth	Dimension(mm)					APMX	Suitable for	Coolant	Shape	Weight (KG)	Stock
			DC	DCX	DCON	LF	LU						
MKM113025R03P25SD09	25	3	9	25	25	110	60	1	SDMT09T307-SM	✓	Fig3	0.32	●
MKM113025R03P25SD09L	25	3	9	25	25	200	50	1	SDMT09T307-SM	✓	Fig3	0.68	●
MKM113032R02P32SD12L	32	2	11	32	32	250	70	2	SDMT120512-SM	✓	Fig3	1.40	●
MKM113032R03P32SD12L	32	3	11	32	32	250	70	2	SDMT120512-SM	✓	Fig3	1.39	●
MKM113032R04P32SD09	32	4	17	32	32	190	140	1	SDMT09T307-SM	✓	Fig3	0.99	●
MKM113032R05P32SD09	32	5	17	32	32	190	140	1	SDMT09T307-SM	✓	Fig3	0.96	●
MKM113035R05P32SD09	35	5	20	35	32	190	140	1	SDMT09T307-SM	✓	Fig3	1.01	●

● Stock ○ Available Upon Order

MKM113

Replaceable Tool Head

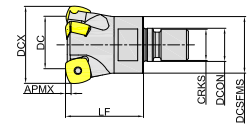

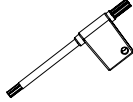

Fig4

Ordering Code	Dia-meter	Teeth	Dimension(mm)						APMX	Suitable for	Coolant	Shape	Weight (KG)	Stock
			DC	DCX	DCON	DCSFMS	LF	CRKS						
MKM113025R03M12SD09	25	3	9	25	12.5	21	33	M12	1	SDMT09T307-SM	✓	Fig4	0.08	●
MKM113032R02M16SD12	32	2	11	32	17	29	40	M16	2	SDMT120512-SM	✓	Fig4	0.16	●
MKM113032R03M16SD12	32	3	11	32	17	29	40	M16	2	SDMT120512-SM	✓	Fig4	0.15	●
MKM113032R04M16SD09	32	4	17	32	17	29	40	M16	1	SDMT09T307-SM	✓	Fig4	0.18	●
MKM113032R05M16SD09	32	5	17	32	17	29	40	M16	1	SDMT09T307-SM	✓	Fig4	0.19	●
MKM113035R03M16SD12	35	3	14	35	17	29	40	M16	2	SDMT120512-SM	✓	Fig4	0.16	●
MKM113035R04M16SD09	35	4	20	35	17	29	40	M16	1	SDMT09T307-SM	✓	Fig4	0.19	●
MKM113035R05M16SD09	35	5	20	35	17	29	40	M16	1	SDMT09T307-SM	✓	Fig4	0.19	●
MKM113042R04M16SD12	42	4	21	42	17	29	52	M16	2	SDMT120512-SM	✓	Fig4	0.27	●

● Stock ○ Available Upon Order

Spare Parts

Part Name		Inserts Screw	Recommended Torque	Insert Screw Wrench	
Inserts	Shape				
	SDMT09T307-SM	Ordering Code SI60M030072-04205WW	1.8N·m	TT09PQ	—
	SDMT120512-GM/GH	Ordering Code SI60M040100-05510IS	3.5N·m	TI15PB	TI15TB
	SDMT120512-SM	Ordering Code SI60M040094-05311IWW	3.5N·m	TI15PB	TI15TB
	SDMT150512-GM/GH	Ordering Code SI60M050108-07214IB	5.0N·m	TI20PB	TI20TB

Parameters for Programing

Specification	Approximate Corner Ratio R(mm)	Remains K(mm)
SDMT09T307-SM	1.7	0.8
SDMT120512-SM	2.1	0.7
SDMT120512-GM/GH	3.7	0.9
SDMT150512-GM/GH	5.0	1.0

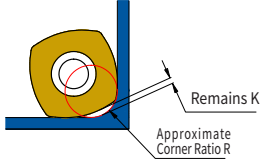

The Relationship of Recommended Feed and Depth of SDMT Inserts

Specification	Feed Rate/Edges fz (mm)	Ap(mm)					
		0.5	1	1.5	2	2.5	3
SDMT09T3	1.2 (0.8-1.5)	0.8 (0.6-1.2)	—	—	—	—	
SDMT1205	1.8 (1.5-2.0)	1.5 (1.0-1.8)	1.0 (0.6-1.5)	0.8 (0.4-1.0)	—	—	
SDMT1505	2.0 (1.8-3.0)	1.8 (1.5-2.0)	1.5 (1.0-1.8)	1.0 (0.6-1.5)	0.8 (0.4-1.0)	0.6 (0.4-0.8)	

Recommended Cutting Data

	Workpiece	Hardness	Grade	Specification	Ap (mm)	Cutting Speed Vc(m/min)	Feed Rate/Edges fz(mm)	
							Medium Cutting(M)	Heavy Cutting(H)
P	Soft Steel	≤ HB180	GA4325 GPM7120	SDMT09T3	0.5	180 (140-220)	0.8 (0.6-1.2)	1.2 (0.8-1.5)
				SDMT1205	1		1.2 (0.8-1.5)	1.5 (1.0-2.0)
				SDMT1505	1.5		1.2 (0.8-1.5)	1.5 (1.0-2.0)
	Carbon Steel, Alloy Steel	HB180-350	GA4325 GPM7120 GP2115	SDMT09T3	0.5	150 (110-190)	0.8 (0.6-1.2)	1.2 (0.8-1.5)
				SDMT1205	1		1.2 (0.8-1.5)	1.2 (0.8-1.5)
				SDMT1505	1.5		1.2 (0.8-1.5)	1.5 (1.0-2.0)
	Pre-hardened Steel	HRC35-45	GPM7120 GA4325 GP2115	SDMT09T3	0.5	120 (80-160)	0.8 (0.6-1.2)	1.2 (0.8-1.5)
				SDMT1205	1		1.0 (0.6-1.2)	1.2 (0.8-1.5)
				SDMT1505	1.5		1.0 (0.6-1.2)	1.2 (0.8-1.5)
M	Stainless (Ferrite, Martensite)	≤ HB270	GM2140 GM4135 GA4230	SDMT09T3	0.5	120 (80-160)	0.8 (0.6-1.2)	1.2 (0.8-1.5)
				SDMT1205	1		0.8 (0.6-1.0)	1.0 (0.8-1.2)
				SDMT1505	1.5		0.8 (0.6-1.0)	1.0 (0.8-1.2)
	Stainless (Austenite, Diphasic)	≤ HB270	GM2140 GM4135	SDMT09T3	0.5	100 (60-140)	0.8 (0.6-1.2)	1.2 (0.8-1.5)
				SDMT1205	1		0.8 (0.6-1.0)	1.0 (0.8-1.2)
				SDMT1505	1.5		0.8 (0.6-1.0)	1.0 (0.8-1.2)
K	Grey Cast Iron	≤ HB280	GK2115 GK4125	SDMT09T3	0.5	180 (140-220)	0.8 (0.6-1.2)	1.2 (0.8-1.5)
				SDMT1205	1		1.2 (0.8-1.5)	1.5 (1.0-2.0)
				SDMT1505	1.5		1.2 (0.8-1.5)	1.5 (1.0-2.0)
	Nodular Cast Iron, Vermicular Graphite Cast Iron	≤ HB350	GK4125 GK2115	SDMT09T3	0.5	120 (80-160)	0.8 (0.6-1.2)	1.2 (0.8-1.5)
				SDMT1205	1		1.2 (0.8-1.5)	1.5 (1.0-2.0)
				SDMT1505	1.5		1.2 (0.8-1.5)	1.5 (1.0-2.0)
S	Heat-resistant Alloy and Titanium Alloy	HRC30-45	GS4130	SDMT09T3	0.5	40 (30-60)	0.4 (0.3-0.7)	0.6 (0.4-1.0)
				SDMT1205	1		0.5 (0.3-0.8)	0.7 (0.4-1.1)
				SDMT1505	1.5		0.5 (0.3-0.8)	0.7 (0.4-1.1)

Slotting Milling

MSA(104~108)

Arbor

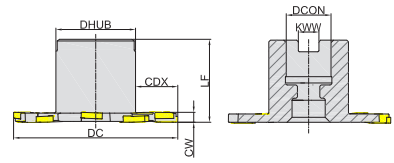
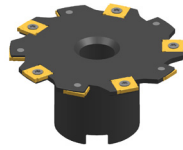

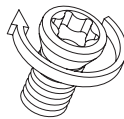
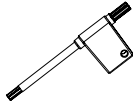

Fig1

Ordering Code	Dia-meter	Teeth	Dimension(mm)							Suitable for	Internal Coolant	Shape	Weight (KG)	Stock
			DC	CW	DCON	CDX	LF	DHUB	KWW					
MSA104100R10A27SN12	100	10	100	4	27	23	50	48	12.4	SNEX1202	×	Fig1	0.61	●
MSA105100R10A27SN12	100	10	100	5	27	23	50	48	12.4	SNEX1203	×	Fig1	0.64	●
MSA106100R10A27SN12	100	10	100	6	27	23	50	48	12.4	SNEX12T3	×	Fig1	0.68	●
MSA107100R10A27SN12	100	10	100	7	27	23	50	48	12.4	SNEX1204	×	Fig1	0.71	●
MSA108100R10A27SN12	100	10	100	8	27	23	50	48	12.4	SNEX12T4	×	Fig1	0.71	●

● Stock ○ Available Upon Order

Spare Parts

Part Name		Inserts Screw	Recommended Torque	Insert Screw Wrench	
Inserts	Shape				
	SNEX1202	Ordering Code	SI90M040032-06003IFQ	1.7N·m	TI08PQ
	SNEX1203	Ordering Code	SI90M040042-06003IFQ	1.7N·m	TI08PQ
	SNEX12T3	Ordering Code	SI90M040051-06003IFQ	1.7N·m	TI08PQ
	SNEX1204	Ordering Code	SI90M040061-06003IFQ	1.7N·m	TI08PQ
	SNEX12T4	Ordering Code	SI90M040071-06003IFQ	1.7N·m	TI08PQ

Recommended Cutting Data



	Workpiece	Hardness	Grade	Specification	Cutting Speed Vc(m/min)	Feed Rate/Edges
						fz(mm) Medium Cutting(M)
P	Soft Steel	≤ HB180	GA4225 GA4230	SNEX12	180 (140-220)	0.1 (0.05-0.15)
	Carbon Steel, Alloy Steel	HB180-350	GA4225 GA4230	SNEX12	160 (120-200)	0.08 (0.05-0.12)
	Pre-harden Steel	HRC35-45	GA4225 GA4230	SNEX12	140 (100-180)	0.06 (0.04-0.1)
M	Stainless (Ferrite, Martensite)	≤ HB270	GM2140 GA4230	SNEX12	120 (80-160)	0.08 (0.05-0.12)
	Stainless (Austenite, Diphasic)	≤ HB270	GA4230 GM2140	SNEX12	100 (60-140)	0.06 (0.04-0.1)
K	Grey Cast Iron	≤ HB280	GK2115 GK4125	SNEX12	200 (160-240)	0.1 (0.02-0.15)
	Nodular Cast Iron, Vermicular Graphite Cast Iron	≤ HB350	GK4125 GK2115	SNEX12	120 (80-160)	0.08 (0.05-0.12)

Slotting Milling

CNEU

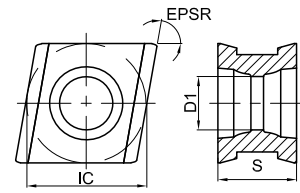
Medium Slot Width and Three-edge Milling Inserts



Ordering Code	Dimension(mm)				Coating Grade										Uncoated	Cermet			
	IC	EPSR	S	D1	GA4225	GA4230	GA4325	GPM7120	GP4225	GP2115	GM4135	GM2140	GK4125	GK2115			GS4130	GH4115	GN9125
 CNEU070508-PM	7.6	80°	5	3.4	●	●													
 CNEU070508-KM	7.6	80°	5	3.4		●													
	CNEU070515-KM	7.6	80°	5	3.4														

● Stock ○ Available Upon Order

Slotting Milling

MSA(110~113)

Arbor

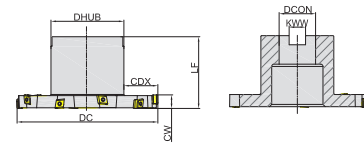
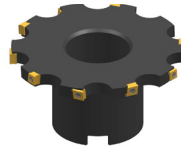

Fig1

Ordering Code	Dia- meter	Teeth	Dimension(mm)							Suitable for	Internal Coolant	Shape	Weight (KG)	Stock
			DC	CW	DCON	CDX	LF	DHUB	KWW					
MSA110080R06B27CN07	80	6	80	10	27	14	50	48	12.4	CNEU0705	×	Fig1	0.50	●
MSA110100R08B32CN07	100	8	100	10	32	19	50	58	14.4	CNEU0705	×	Fig1	0.78	●
MSA110125R10B32CN07	125	10	125	10	32	29.5	63	64	14.4	CNEU0705	×	Fig1	1.39	●
MSA110160R12B40CN07	160	12	160	10	40	43	63	70	16.4	CNEU0705	×	Fig1	1.80	●
MSA111080R06B27CN07	80	6	80	11	27	14	50	48	12.4	CNEU0705	×	Fig1	0.52	●
MSA111100R08B32CN07	100	8	100	11	32	19	50	58	14.4	CNEU0705	×	Fig1	0.81	●
MSA111125R10B32CN07	125	10	125	11	32	29.5	63	64	14.4	CNEU0705	×	Fig1	1.44	●
MSA111160R12B40CN07	160	12	160	11	40	43	63	70	16.4	CNEU0705	×	Fig1	1.91	●
MSA112080R06B27CN07	80	6	80	12	27	14	50	48	12.4	CNEU0705	×	Fig1	0.54	●
MSA112100R08B32CN07	100	8	100	12	32	19	50	58	14.4	CNEU0705	×	Fig1	0.84	●
MSA112125R10B32CN07	125	10	125	12	32	29.5	63	64	14.4	CNEU0705	×	Fig1	1.49	●
MSA112160R12B40CN07	160	12	160	12	40	43	63	70	16.4	CNEU0705	×	Fig1	2.01	●
MSA113080R06B27CN07	80	6	80	13	27	14	50	48	12.4	CNEU0705	×	Fig1	0.55	●
MSA113100R08B32CN07	100	8	100	13	32	19	50	58	14.4	CNEU0705	×	Fig1	0.87	●
MSA113125R10B32CN07	125	10	125	13	32	29.5	63	64	14.4	CNEU0705	×	Fig1	1.55	●
MSA113160R12B40CN07	160	12	160	13	40	43	63	70	16.4	CNEU0705	×	Fig1	2.11	●

● Stock ○ Available Upon Order

Slotting Milling

MSA(110~113)

Shell

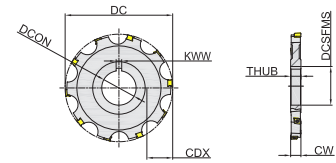
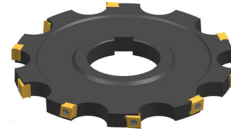
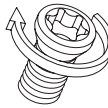
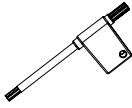

Fig2

Ordering Code	Dia-meter	Teeth	Dimension(mm)							Suitable for	Coolant	Shape	Weight (KG)	Stock
			DC	CW	DCON	CDX	THUB	DCSFMS	KWW					
MSA110080R06K27CN07	80	6	80	10	27	19	10	40	7	CNEU0705	×	Fig2	0.21	●
MSA110100R08K27CN07	100	8	100	10	27	26	10	46	7	CNEU0705	×	Fig2	0.36	●
MSA110125R10K40CN07	125	10	125	10	40	34	10	55	10	CNEU0705	×	Fig2	0.52	●
MSA110160R12K40CN07	160	12	160	10	40	51	10	55	10	CNEU0705	×	Fig2	0.91	●
MSA111080R06K27CN07	80	6	80	11	27	19	11	40	7	CNEU0705	×	Fig2	0.23	●
MSA111100R08K27CN07	100	8	100	11	27	26	11	46	7	CNEU0705	×	Fig2	0.40	●
MSA111125R10K40CN07	125	10	125	11	40	34	11	55	10	CNEU0705	×	Fig2	0.59	●
MSA111160R12K40CN07	160	12	160	11	40	51	11	55	10	CNEU0705	×	Fig2	1.03	●
MSA112080R06K27CN07	80	6	80	12	27	19	12	40	7	CNEU0705	×	Fig2	0.26	●
MSA112100R08K27CN07	100	8	100	12	27	26	12	46	7	CNEU0705	×	Fig2	0.44	●
MSA112125R10K40CN07	125	10	125	12	40	34	12	55	10	CNEU0705	×	Fig2	0.65	●
MSA112160R12K40CN07	160	12	160	12	40	51	12	55	10	CNEU0705	×	Fig2	1.15	●
MSA113080R06K27CN07	80	6	80	13	27	19	13	40	7	CNEU0705	×	Fig2	0.28	●
MSA113100R08K27CN07	100	8	100	13	27	26	13	46	7	CNEU0705	×	Fig2	0.49	●
MSA113125R10K40CN07	125	10	125	13	40	34	13	55	10	CNEU0705	×	Fig2	0.72	●
MSA113160R12K40CN07	160	12	160	13	40	51	13	55	10	CNEU0705	×	Fig2	1.27	●

● Stock ○ Available Upon Order

Spare Parts

Part Name		Inserts Screw	Recommended Torque	Insert Screw Wrench
Inserts	Shape			
	CNEU0705	Ordering Code	SI60M030090-04205S	1.8N·m

Recommended Cutting Data

	Workpiece	Hardness	Grade	Specification	Cutting Speed Vc(m/min)	Feed Rate/Edges
						fz(mm) Medium Cutting(M)
P	Soft Steel	≤ HB180	GA4225 GA4230	CNEU0705	180 (140-220)	0.1 (0.05-0.15)
	Carbon Steel, Alloy Steel	HB180-350	GA4225 GA4230	CNEU0705	160 (120-200)	0.08 (0.05-0.12)
	Pre-harden Steel	HRC35-45	GA4225 GA4230	CNEU0705	140 (120-180)	0.06 (0.04-0.1)
M	Stainless (Ferrite, Martensite)	≤ HB270	GM2140 GA4230	CNEU0705	120 (80-160)	0.08 (0.05-0.12)
	Stainless (Austenite, Diphasic)	≤ HB270	GA4230 GM2140	CNEU0705	100 (60-140)	0.06 (0.04-0.1)
K	Grey Cast Iron	≤ HB280	GK2115 GK4125	CNEU0705	200 (160-240)	0.1 (0.02-0.15)
	Nodular Cast Iron, Vermicular Graphite Cast Iron	≤ HB350	GK4125 GK2115	CNEU0705	120 (80-160)	0.08 (0.05-0.12)

Chamfer Milling

MCA130

Side Clamp Type

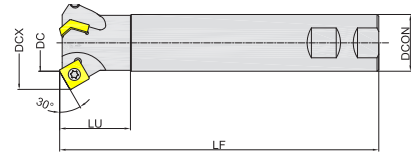

Fig1

Ordering Code	Dia-meter	Teeth	Dimension(mm)					APMX	Suitable for	Coolant	Shape	Weight (KG)	Stock
			DC	DCX	DCON	LF	LU						
MCA130025R02W25SP09	25	2	25	40	25	120	40	3	SPMT09T3	×	Fig1	0.44	●
MCA130032R03W32SP12	32	3	32	52	32	180	40	4.5	SPMT1204	×	Fig1	1.07	●

● Stock ○ Available Upon Order

MCA145

Side Clamp Type

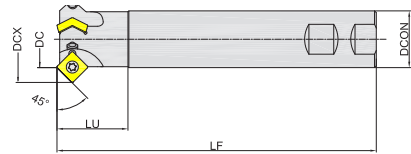

Fig2

Ordering Code	Dia-meter	Teeth	Dimension(mm)					APMX	Suitable for	Coolant	Shape	Weight (KG)	Stock
			DC	DCX	DCON	LF	LU						
MCA145025R02W25SP09	25	2	25	37	25	120	40	5	SPMT09T3	×	Fig2	0.43	●
MCA145032R03W32SP12	32	3	32	49	32	180	40	7	SPMT1204	×	Fig2	1.06	●

● Stock ○ Available Upon Order

MCA160

Side Clamp Type

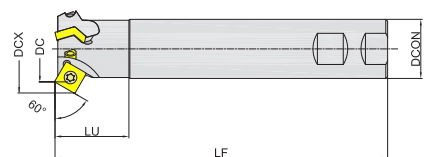

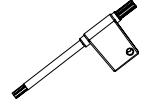

Fig3

Ordering Code	Dia-meter	Teeth	Dimension(mm)					APMX	Suitable for	Coolant	Shape	Weight (KG)	Stock
			DC	DCX	DCON	LF	LU						
MCA160025R02W25SP09	25	2	25	34	25	120	40	6	SPMT09T3	×	Fig3	0.41	●
MCA160036R03W32SP12	36	3	36	48	32	180	40	8	SPMT1204	×	Fig3	1.06	●

● Stock ○ Available Upon Order

Spare Parts

Part Name		Inserts Screw	Recommended Torque	Insert Screw Wrench
Inserts	Shape			
	SPMT09T3	Ordering Code	SI60M040089-05313S	3.5N · m
SPMT1204	Ordering Code	SI60M050108-07209S	5.0N · m	TT20PQ

Recommended Cutting Data

	Workpiece	Hardness	Grade	Specification	Cutting Speed Vc(m/min)	Feed Rate/Edges fz(mm)
						Medium Cutting(M)
P	Soft Steel	≤ HB180	GA4225 GA4230	SPMT09T3	180 (140-220)	0.2 (0.15-0.25)
				SPMT1204	180 (140-220)	0.25 (0.2-0.3)
	Carbon Steel, Alloy Steel	HB180- 350	GA4225 GA4230 GP2115	SPMT09T3	160 (120-200)	0.2 (0.15-0.25)
				SPMT1204	160 (120-200)	0.25 (0.2-0.3)
	Pre-harden Steel	HRC35-45	GA4230 GA4225 GP2115	SPMT09T3	120 (80-160)	0.15 (0.1-0.2)
				SPMT1204	120 (80-160)	0.2 (0.15-0.25)
M	Stainless (Ferrite, Martensite)	≤ HB270	GM2140 GA4230	SPMT09T3	120 (80-160)	0.15 (0.1-0.2)
				SPMT1204	120 (80-160)	0.2 (0.15-0.25)
	Stainless (Austenite, Diphasic)	≤ HB270	GM2140	SPMT09T3	100 (60-140)	0.15 (0.1-0.2)
				SPMT1204	100 (60-140)	0.2 (0.15-0.25)
K	Grey Cast Iron	≤ HB280	GK2115 GK4125	SPMT09T3	160 (120-200)	0.2 (0.15-0.25)
				SPMT1204	160 (120-200)	0.25 (0.15-0.3)
	Nodular Cast Iron, Vermicular Graphite Cast Iron	≤ HB350	GK4125 GK2115	SPMT09T3	140 (100-180)	0.15 (0.1-0.2)
				SPMT1204	140 (100-180)	0.2 (0.15-0.25)

B

SOLID CARBIDE ENDMILLS



GESAC Coating

Coating Characteristic

Coatings	Microhardness (HV0.05)	Coefficient Friction	Max. service Temperature (°C)	Characteristic and Application
AlCrN	3200	0.45	1100	High oxidation resistance, extremely good of high temperature abrasion resistance, suitable for ordinary steel, low hardness of die steel or titanium.
AlCrSiN	3300	0.4	1100	Specially designed for milling, high oxidation resistance, good balance of abrasion resistance and toughness, strong versatility, suitable for ordinary steel under HRC55, die steel and titanium alloy milling.
TiAlN	2900	0.35	900	Super-high micro hardness and fine-grain, suitable for stainless steel, some high hard steel drying cutting and titanium alloy milling.
AlTiN Nano	3000	0.45	900	Extremely crystal texture control, good balance of micro hardness and toughness, universal milling and drilling coatings, suitable for stainless steel, high hard steel moderately high speed and high feed cutting.
AlCrN/TiSiN	3100	0.35	1100	High oxidation resistance, good hot hardness, good toughness, and super-smooth surface, suitable for stainless steel and cast iron drilling.
AlTiN/TiSiN Multilayer	3300	0.35	1100	Super high thermal-stability, super toughness, bit general coating, especially suitable for ordinary steel drilling.
TiAlCrSiN	4000	0.35	1100	High micro hardness, high oxidation resistance and hot hardness, suitable for high hard steel above 55HRC milling.
TiAlSiN	4000	0.35	1200	High micro hardness, high oxidation resistance and hot hardness, suitable for high hard steel above 55-65HRC milling.
Ti-rich Coating	4000	0.35	900	High hardness, good self-lubrication and excellent adhesion resistance; Suitable for processing non-ferrous metals such as titanium alloys and aluminium alloys.
Normal Diamond Coating	8500	-	700	High hardness, thermal conductivity and wear resistance, suitable for graphite machining.
Ultra-fine Grain Diamond Coating	8000	-	700	Smooth surface, good self-lubricity, hardness, thermal conductivity and wear resistance, suitable for nonferrous materials, carbon fiber composite machining, etc.

Position of Main PVD Nano-structure Coating

PVD coating provides for superior control of coating grain size (from 10nm to 500nm), achieves excellent hardness, good oxidation resistant, and improved reduction of the coefficient of friction.

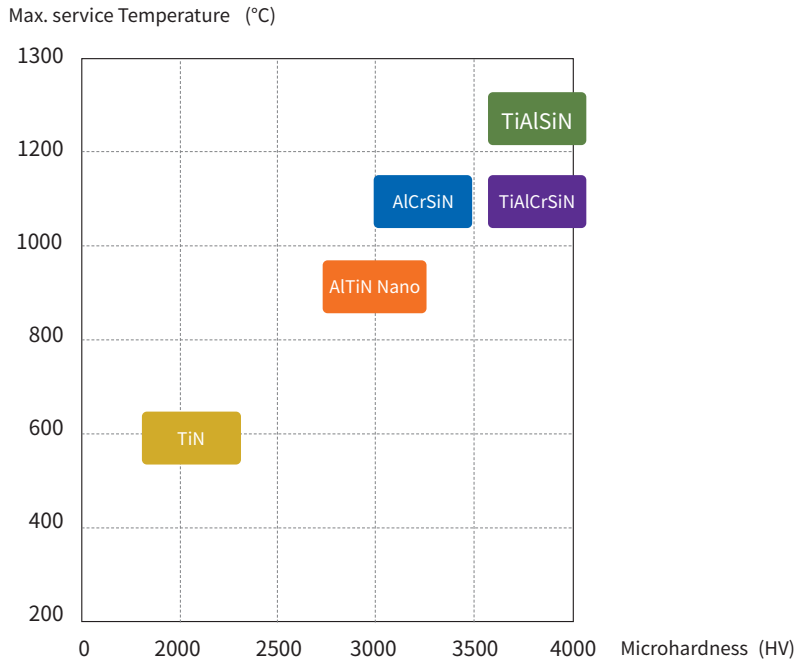

Microhardness and Max. Service Temperature

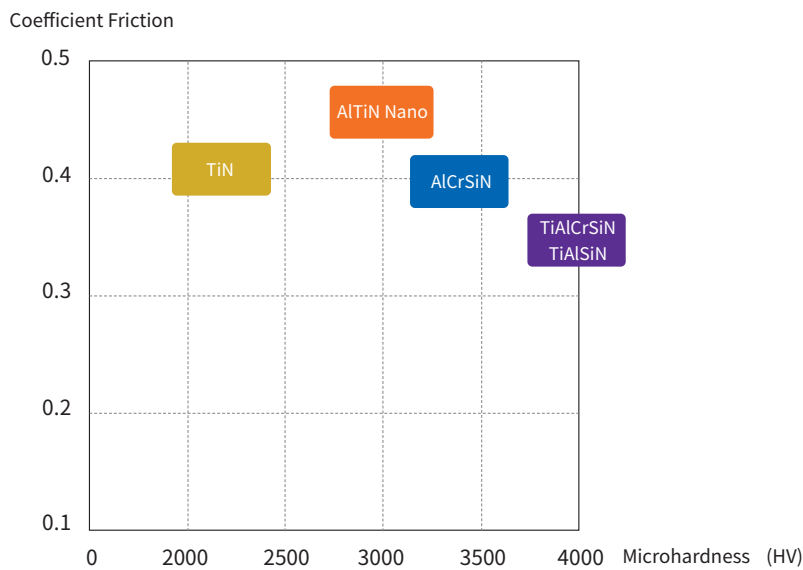

Microhardness and Coefficient of Friction

Universal High Performance Coating AlCrSiN

- Productivity increases due to significantly higher cutting speed and feed for application in a wide range of materials.
- The particular design of the structure brings a good balance between toughness, thermo-shock stability, and residual stress.

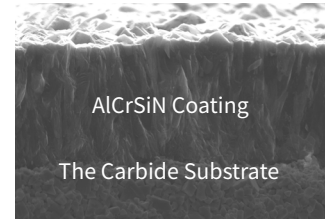

SEM Photograph of Coating

High Hardness Coating TiAlSiN

- Micro-hardness up to 4000HV with good wear resistance.
- Special transition layer design ensures high bonding strength between high-hardness coating and substrate, with adhesion up to 100N.
- Nano-composite coating design provides super strong oxidation resistance, with oxidation starting at temperatures as high as 1200°C and high temperature stability.



SEM Photograph of Coating

Nano Coating AlTiN

- High aluminium content provides excellent hot hardness and oxidation resistance.
- Special method optimizes the structure of coating, significantly improve stability, reducing the number of surface droplet.

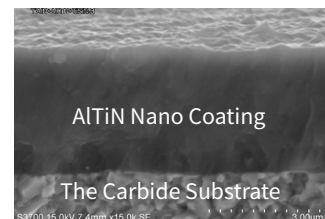

SEM Photograph of Coating

Ultra-fine Grain Diamond Coating

- High purity diamond coating, with hardness up to 80GPa.
- Ultra smooth and shiny surface, low friction coefficient.
- Suitable for finish machining nonferrous materials, such as graphite, aluminium, carbon fiber, ceramic, etc.

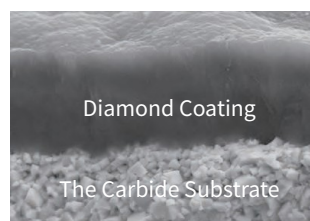

SEM Photograph of Coating

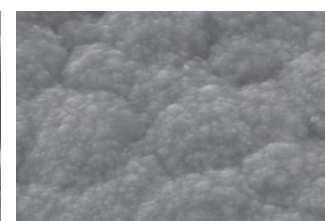

Surface Morphology

Normal Diamond Coating

- High purity diamond coating, with hardness up to 85GPa.
- High wear-resisting diamond coating, with extremely high hardness and strong wear resistance.
- Suitable for graphite machining.

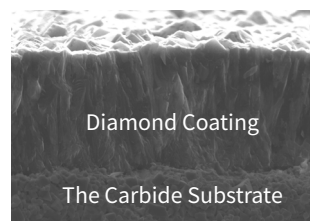



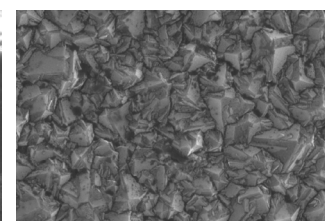































SEM Photograph of Coating

















Surface Morphology

Guidelines to Icons

	Mark	Description
Shank		ISO Standard Shank h5
		ISO Standard Shank h6
Coating		AlCrN Coating
		AlCrSiN Coating
		AlTiN Coating
		Nano Coating AlTiN
		AlCrN/TiSiN Coating
		Nano Coating AlTiN/TiSiN
		TiAlCrSiN Coating
		TiAlSiN Coating
		Ti-rich Coating
		Normal Diamond Coating
		Ultra-fine Grain Diamond Coating
	Cutting Condition	
		Slot Milling
		Profile Milling
		Spiral Milling
		Trochoidal Milling



	Mark	Description
Helix		-20° Helix
		15° Helix
		20° Helix
		28° Helix
		30° Helix
		35° Helix
		38° Helix
		40° Helix
		45° Helix
		Variable Helix
		Variable Helix
		Variable Helix
		Variable Helix
No. of Flutes		1 Flute
		2 Flutes
		3 Flutes
		4 Flutes

	Mark	Description
No. of Flutes		5 Flutes
		6 Flutes
		12 Flutes
End Teeth Type		Square
		Corner Radius
		Ballnose
		Square with Chamfer
		Chamfer
Workpiece Material		Steel
		Stainless Steel
		Cast Iron
		Non-ferrous Materials
		Heat-resistant Super Alloys, Titanium Alloys
		High Hardened Materials

Solid Carbide Endmills Identification System

UP210 -

①

Workpiece	①Code of Series	Series Description
Steel, Cast Iron	UP210	General Machining Series(\leq 48HRC)
	SP210	High Efficiency Machining Series(\leq 48HRC)
	PP300	High Efficiency Machining Series (\leq 48HRC)
	UPN210	General Rough Machining Series(\leq 48HRC)
	UPR210	General Rough Machining Series(\leq 48HRC)
	UPR300	General Rough Machining Series(\leq 48HRC)
Stainless Steel	US200	General Machining Series for Stainless Steel
	US260	General Machining Series for Stainless Steel
	SS600	High Efficiency Machining Series for Stainless Steel
Aluminium Alloy	UA100	General Machining Series for Aluminium
	SA100	High Efficiency Machining Series for Aluminium
	SA160	 Appearance Machining Series for Aluminium
	SA210	 Rough Machining Series for Aluminium
	SA300	 High Speed Machining Series for Aluminium
	DNM100	PCD Round-head Endmill
Graphite	SG200	High Speed Machining for Graphite
Composite Materials	SD200	General Machining for Composite Material
Heat Resistant Super Alloys	SN200	High Efficiency Machining Series for Heat Resistant Super Alloys
Titanium Alloys	ST210	High performance Machining Series for Titanium Alloys
High Hardened Material	SH160	General Machining Series for Hardness Steels(48~55HRC)
	FH200-H	High Feed Machining Series for Hardened Steels (35-65HRC)



②

②End Teeth Type	
S	Square
B	Ballnose
R	Cornor Radius
C	Square with Chamfer

③

③Length of Flute	
N	Long Neck
H	Long Shank
L	Long Flute
S	Short Flute
Blank	Standard

④

④No. of Flutes	
	2
	3
	4
	6

⑤

⑤Diameter	
006	0.6mm
060	6mm
100	10mm

⑥

⑥Characteristic Code	
1	Square\Ballnose: a. Neck Length b. Flute Length 06-6mm 10-10mm
2	Cornor Radius: 02-R0.2mm 10-R1mm
3	Chamfered Corner: 03-C0.03mm 13-C0.13mm

Solid Carbide Endmills Identification System

SPM200 -



Workpiece	①Code of Series	Series Description
Steel, Cast Iron, Copper Alloy, High Hardened Material	SPM200	High Efficient Micro Diameter Machining Series ($\leq 55\text{HRC}$)
High Hardened Material	SH260-H	General Machining Series for High Hardened Material (30-60HRC)
	SH360	Machining Series for High Hardened Material (45-65HRC)
	SHM200	High Efficient Micro Diameter Machining Series for High Hardened Material (45-65HRC)

SG200-M -



Workpiece	①Code of Series	Series Description
Graphite	SG200-M	High Speed Machining of Graphite

R N 2 - 1 - 4 - 0.1 - V

② End Teeth Type		③ Length of Flute		④ No. of Flutes		⑤ Diameter		⑥ Eigenvalues Neck Length/Shank Length/Flute Length		⑦ Corner Radius		⑧ Coating Symbol	
S	Square	N	Long Neck	2		0.6	0.6mm	0.5	0.5mm	0.5	0.5mm		
B	Ballnose	H	Long Shank	3		6	6mm	1	1mm	1	1mm		
R	Corner Radius	L	Long Flute	4				10	10mm	None	No Corner Radius		
		S	Short Flute	6				100	100mm				
		Blank	Standard										

R N 4 - 1 - 4 - 0.1 - 50

② End Teeth Type		③ Length of Flute		④ No. of Flutes		⑤ Diameter		⑥ Eigenvalues Neck Length/Shank Length/Flute Length		⑦ Corner Radius		⑧ Total Length	
S	Square	N	Long Neck	2		0.6	0.6mm	0.5	0.5mm	0.5	0.5mm	50	50mm
B	Ballnose	H	Long Shank	3		6	6mm	1	1mm	1	1mm		
R	Corner Radius	L	Long Flute	4				10	10mm	None	No Corner Radius		
		S	Short Flute	6				100	100mm				
		Blank	Standard										

Solid Carbide Endmills Identification System

SM200 -



Workpiece	①Code of Series	Series Description
Zirconia&Titanium Alloys	SM200	Endmills for Denture

RO - 2 - 0.6 - 6 - 50 - d4

② ③ ④ ⑤ ⑥ ⑦

③ No. of Flutes
2
3

④ Diameter	
0.6	0.6mm
6	6mm

⑤ Neck Length	
0.5	0.5mm
1	1mm
10	10mm

⑥ Total Length	
50	50mm
60	60mm

⑦ Shank Diameter	
d4	4mm
d6	6mm

② Compatible Device Code	
RO	Roland
VH	VHF
WI	Willand
IM	IMES-ICORE
ZI	Conze
AR	ARUM
XT	Xiangtong
KL	Collard
TP	Titanium Alloy Machining

Application Summary

ISO Material Group	MC GESAC	General Machining	Roughing	High Efficiency Machining	High Speed Machining	Micro Machining	Special Machining	
P	1 2 3 4	Carbon Steel, Alloy Steel (<35HRC)	UP210	UPN210 UPR210 UPR300	SP210 PP300	SPM200		
	5	Alloy Steel (35-48HRC)						
	6	PH,Ferritic,Martensitic Steel(<35HRC)						
M	1 2 3	Stainless Steel	US200 US260		SS600		SPM200	
K	1 2	Grey Cast Iron,Nodular Cast Iron (<32HRC)	UP210	UPN210 UPR210 UPR300	SP210 PP300	SPM200		
	3	High-alloy Cast Iron (35-45HRC)						
N	1 2	Rought Aluminium Alloys/Cast Aluminium Alloys (Si≤12%)	UA100 DNM100	SA210 NEW	SA100	SA300 NEW	SA160 NEW	
	3	Cast Aluminium Alloys (Si>12%)	DNM100				SPM200	
	4	Copper Alloys (<200HB)	UA100 DNM100					
	5	Graphite, Composite Material	SD200 DNM100			SG200 SG200-M SM200		
S	1 2 3	Heat Resistant Super Alloys (<450HB)	SN200				SPM200	
	4	Titanium Alloys (<400HB)	ST210			SM200		
H	1	Hardened Steel(45-55HRC)	SH160 SH260-H					
	2	Hardened Steel(55-60HRC)	SH260-H		FH200-H	SH260-H	SH360 SHM200	
	3 4	Hardened Steel (>60HRC)						

Series Introduction

▼ UP210 Endmills for General Machining of Steel

- Suitable for steels & cast iron ($\leq 48\text{HRC}$).
- High performance AlCr series coating with high temperature resistance and high wear resistance.
- Adapt to oil mist, water, oil, air cooling and other cooling conditions.



▼ SP210 Endmills for High Efficiency Machining of Steel

- Suitable for high efficiency machining of steels & cast iron ($\leq 48\text{HRC}$).
- Variable helix angle and unequal flute pitch with excellent anti-vibration capacity.
- Applicable to high efficiency machining of large cutting depth (a_p), large cutting width (a_e) (Machine with good rigidity).



▲ PP300 Endmills for High Efficiency Machining of Steel

- Suitable for side milling, slot milling, spiral interpolation milling, cycloidal milling and other efficient machining of ordinary steel and cast iron materials ($\leq 48\text{HRC}$), with high metal removal rate.
- Unequal tooth pitch, unequal spiral design, effective suppression of high field tremor, play a superior seismic ability, to achieve large cutting depth, large cutting width efficient and stable processing.
- The design of variable groove depth ensures that the tool has enough chip discharge space and sufficient rigidity.



▲ UPN210 Endmills for General Rough Machining of Steel

- Suitable for semi-finishing and roughing of steels and cast iron with high metal removal rate.
- GU cemented carbide substrate with high-performance AlCrSiN nano-coating provides a perfect match of high wear resistance and toughness.
- Special chip-breaking design produces short chips during processing for smooth chip removal and high-quality stable machining.
- Special R-type groove design ensures good chip evacuation.

Series Introduction

▼ UPR210 Waveform Endmill for Steel

- Suitable for roughing of steels & cast iron ($\leq 48\text{HRC}$), with high metal removal rate.
- GU cemented carbide substrate with high performance AlCrSiN nano-coating, to realize perfect match both high wear resistance and toughness.
- 45° helix angle and special U type groove design, realize smoothly cutting.
- Adopt the standard waveform tooth design, make short chips during processing. Excellent chip removal performance, realized high quality and stable processing.



▼ UPR300 Waveform Endmills for Steel

- Suitable for roughing at large cutting depth (a_p) and large cutting width (a_e) of steels and cast iron ($\leq 48\text{HRC}$) with high metal removal rate.
- Dense tooth type and waveform tooth design produce ultra-fine chips during processing for excellent chip removal, low resistance cutting performance, and low machine load.
- Special edge processing effectively improves the tool's collapse resistance and wear resistance during rough machining.



▲ US200 Endmills for General Machining of Stainless Steel

- Suitable for general machining of stainless steel ($< 280\text{HB}$).
- Special edge design, effectively solve the crumbs.
- Water, oil cooling as the best cooling method.



▲ US260 Endmills for General Machining of Stainless Steel

- Suitable for roughing and finishing of stainless Steel ($< 380\text{HB}$)
- Updating cemented carbide substrate with high performance nano-coating, to realize perfect match both high wear resistance and toughness.
- Suitable for high feed rate machining, face milling, side milling, slotting ($a_p \leq 0.1D$).
- Oil or water cooling will be preferred.

Series Introduction



▲ SS600 Endmills for High Efficiency Milling of Stainless Steel

- Suitable for processing high strength steel, precipitation hardening stainless steel, titanium alloy, etc.
- Excellent slot milling performance, high cutting edge strength and anti-collapse edge.
- Unequal spiral and unequal graduation design, stable cutting process.
- Parabolic chip flute design with excellent chip removal ability.

▼ DNM100 Endmills of Standard PCD Corner Radius

- Using composite materials with good wear resistance and unique cutting edge treatment to ensure the quality and long life.
- Suitable for aluminium alloy ,graphite, composite material in roughing,semi-finishing and finishing.



▼ UA100 Endmills for General Machining of Aluminium Alloy

- Suitable for aluminium alloy ($Si \leq 12\%$) and copper alloy ($< 200HB$) general processing.
- Special edge design, reduces vibration, effectively solve the crumbs.
- Water cooling is the best cooling method.



Series Introduction



▲ SA100 Endmills for High Efficiency Milling of Aluminium Alloy

- Suitable for high efficiency roughing and semi-finishing of aluminium alloy ($Si \leq 12\%$).
- The product has unique groove design and rake face polishing process, which could enhance chip removal performance and meet the needs of high efficient processing.
- Applicable for high efficiency machining at large cutting depth (ap), large cutting width (ae), high material removal rate.



▲ SA160 Endmills for Appearance Machining of Aluminium Alloy

- Suitable for aluminium alloy finishing (appearance processing).
- Unique geometry design and high grinding quality, to meet the requirements of high appearance processing.
- Machining appearance without cutter line, double surface defects, to achieve stable appearance processing.

▼ SA210 Endmills for Roughing of Aluminium Alloy

- Adopting the waveform endmill suitable for high efficiency roughing of aluminium alloy.
- Special wavy tooth design, high metal removal rate.
- Vibration suppression tool design, high-speed cutting process is stable.



▼ SA300 Endmills for High Speed Machining of Aluminium Alloy

- Suitable for high speed machining of aviation aluminium alloy.
- The combination of special design and sophisticated manufacturing, the dynamic balance performance of the tool.
- Ultra-fine grained cemented carbide with super wear resistance and high toughness.
- Unique sharp cutting edge design, light and smooth cutting, improve machining efficiency and workpiece surface quality.



Series Introduction



▲ SG200 Endmills for Machining of Graphite

- Diamond coating and enhanced adhesion between coating and substrate provide high adhesion and tool toughness.
- High-purity diamond coating film with good wear resistance ensures long-life processing.
- Suitable for semi-finishing and finishing of graphite workpieces, such as graphite electrode and graphite products. Air cooling is recommended.



▲ SD200 Endmills for High Performance Machining of Composite Material

- Suitable for aerospace carbon fiber composite material side and groove milling.
- Using diamond coating to improve tool life.
- The left and right interleaved edge design can effectively suppress the flanging and delamination of the workpiece.

▼ SG200-M Endmills for Graphite Mold

- High-purity diamond coating, suitable for processing all kinds of high and low hardness graphite, with superior wear resistance.
- Special pretreatment, ensures good surface quality.
- Suitable for 3C electronics industry 3D curved glass graphite mould, with high precision, specialized processing. Air cooling is recommended.



▼ SN200 Endmills for High Efficient Machining of Heat Resistant Alloys

- Suitable for heat resistant super alloys (Inconel 718, GH 4169, etc.) and stainless steel materials.
- High performance treatment, the unique inserts design ensures high rigidity and excellent vibration resistance.
- Special circumferential treatment can increase the strength of cutting edge and ensure the quality of cutting surface.



Series Introduction

▼ SM200 Endmills for Denture

- High-precision dimensional tolerance design to ensure the accuracy of denture processing.
- Sharp cutting edge design produces excellent product surface quality.
- Advanced coating technology, high tool wear resistance.
- Suitable for processing zirconia, titanium alloy, cobalt chromium alloy and other processing in the dental industry.



▼ ST210 Endmills for High Performance Machining of Titanium Alloys

- Suitable for high performance machining of titanium alloys (TA7, TC4, TC18) and stainless steel.
- Unequal flute pitch, unequal helix, effectively improved anti-vibration performance, higher surface quality.
- Eccentric arc relief angle design improves edge strength and guarantees surface quality.
- Special body for hard working materials, ensures longer tool life.



▲ SH160 Endmills for Machining of Hardened Steels (48-55HRC)

- High hardness, high toughness substrate, special angle design, used for the processing of hardened steel.
- Suitable for 48-55HRC hardened steel finishing.
- Air cooling or oil mist cooling is recommended.



▲ SH260-H Endmills for General Machining of Hardened Steels

- Suitable for semi-finishing and finishing of 30~60HRC Hardened Steels;
- Super fine carbide substrate with high strength and toughness combined with special high hard coating significantly lengthens tool life.
- Unique groove structure realizes excellent machining for harden steels materials.
- Air and oil mist cooling are the best cooling methods.

Series Introduction

▼ SH360 Endmills for High Speed Machining of Hardened Steels

- Suitable for finishing and semi-finishing of 45 ~ 65 HRC high hardness materials.
- The substrate material with high strength and toughness is matched with the newly developed coating with high hardness, which can effectively extend service life of cutting tools.
- Unique groove structure, achieving excellent processing of high hardness steel.
- It is recommended to use oil cooling or oil mist.



▼ FH200-H Endmills for High Feed Processing of Hardened Steels

- Dedicated to high feed rough machining of 35-65HRC high hardness material.
- Special-purpose tool type design realizes thin cutting effect, high feed machining, improves the processing efficiency.
- Latest super fine carbide substrate with hard coating ensures high wear-resistance and high thermal stability under various working conditions.



▲ SHM200 Endmills of Micro Diameter for Deep Machining

- Adopt GU ultra-fine grain substrate+TiAlSiN high performance nano coating.
- Special angle and reduced neck design.
- High precision edge diameter precision, high precision head contour, high precision cutter Handle (h5).
- Suitable for hardened steel, pre-hardened steel and other materials (hardness \leq HRC65) . Precise deep hole machining.











▲ SPM200 Endmills of Micro Diameter for Deep Machining

- Suitable for deep groove micromachining of carbon steel, alloy steel, hardened steel, copper, aluminium alloy and other materials (\leq HRC55) in the precision mould industry.
- High precision of edge diameter, ball head contour, R arc contour and shank(h5).
- The high performance AlCrSiN nano-coating with high heat resistance and resistance.
- Special angle and space avoidance design.

Endmill Catalog (by Series)

Suitable Material	No. of Flutes	End Teeth Type	Coating	Description	Type	Diameter Range	Dimension Page	Cutting Parameters Page
-------------------	---------------	----------------	---------	-------------	------	----------------	----------------	-------------------------

UP210

Steel Cast Iron				2 Flutes, Stub Length 	UP210-SS2	D1 ~ D20	232	544
				2 Flutes, Standard Length 	UP210-S2	D1 ~ D20	233	544
				2 Flutes, with Long Flute Length 	UP210-SL2	D2 ~ D20	235	544
				2 Flutes, with Long Shank Length 	UP210-SH2	D2 ~ D20	236	544
				3 Flutes, Standard Length 	UP210-S3	D2 ~ D25	237	544
				4 Flutes, Stub Length 	UP210-SS4	D1 ~ D20	238	545
				4 Flutes, Standard Length 	UP210-S4	D1 ~ D22	239	545
				4 Flutes, with Long Flute Length 	UP210-SL4	D1 ~ D20	241	545
				4 Flutes, with Long Shank Length 	UP210-SH4	D2 ~ D20	243	545
				4 Flutes, Acute Angle 	UP210-SC4	D4 ~ D20	244	545
				4 Flutes, 45° Helix 	UP210-S4A	D4 ~ D20	245	545
				6 Flutes, Standard Length 	UP210-S6	D6 ~ D20	246	545
				2 Flutes, Corner Radius 	UP210-R2	D1 ~ D20	247	544
				2 Flutes Corner Radius, with Long Shank Length 	UP210-RH2	D4 ~ D20	250	544
				4 Flutes, Corner Radius 	UP210-R4	D1 ~ D20	252	545
				4 Flutes Corner Radius, with Long Shank Length 	UP210-RH4	D3 ~ D20	255	545
				4 Flutes, 45° Helix 	UP210-R4A	D4 ~ D20	257	545
				2 Flutes, Ballnose 	UP210-B2	D0.8 ~ D20	259	547
				2 Flutes Ballnose, with Long Shank Length 	UP210-BH2	D2 ~ D20	261	547

 Most Suitable  Suitable

Workpiece Material											
P		M	K	N			S		H		
1 2 3 4	5 6	1 2 3	1 2 3	1 2 3	4	5	1 2 3	4	1	2	3 4
Carbon Steel, Alloy	Alloy Steel	Stainless Steel	Cast Iron	Aluminium Alloys	Copper Alloys	Graphite, Composite Materials	Heat Resistant Super Alloys	Titanium Alloys	Hardened Steel	Hardened Steel	Hardened Steel
< 35HRC		≤ 48HRC							45-55HRC	55-60HRC	> 60HRC

	⊙	⊙	○	⊙							
	⊙	⊙	○	⊙							
	⊙	⊙	○	⊙							
	⊙	⊙	○	⊙							
	⊙	⊙	○	⊙							
	⊙	⊙	○	⊙							
	⊙	⊙	○	⊙							
	⊙	⊙	○	⊙							
	⊙	⊙	○	⊙							
	⊙	⊙	○	⊙							
	⊙	⊙	○	⊙							
	⊙	⊙	○	⊙							
	⊙	⊙	○	⊙							
	⊙	⊙	○	⊙							
	⊙	⊙	○	⊙							
	⊙	⊙	○	⊙							
	⊙	⊙	○	⊙							
	⊙	⊙	○	⊙							
	⊙	⊙	○	⊙							
	⊙	⊙	○	⊙							
	⊙	⊙	○	⊙							
	⊙	⊙	○	⊙							

Endmill Catalog (by Series)

Suitable Material	No. of Flutes	End Teeth Type	Coating	Description	Type	Diameter Range	Dimension Page	Cutting Parameters Page	
UP210									
				4 Flutes, Ballnose		UP210-B4	D2 ~ D20	263	547
				4 Flutes, 60° Chamfer Endmills		UP210-L60	D4 ~ D20	264	548
				4 Flutes, 90° Chamfer Endmills		UP210-L90	D4 ~ D20	265	548
				4 Flutes, 120° Chamfer Endmills		UP210-L120	D4 ~ D20	266	548
SP210									
Steel Cast Iron				3 Flutes, Variable Helix		SP210-S3	D2.5 ~ D20	267	548
				3 Flutes, Variable Helix with Chamfer		SP210-C3	D6 ~ D16	268	548
				4 Flutes, with Variable Helix		SP210-S4	D2 ~ D20	269	549
				4 Flutes, Variable Helix with Chamfer		SP210-C4	D3 ~ D20	270	549
				4 Flutes, Long Neck, Variable Helix with Chamfer		SP210-CN4	D3 ~ D20	272	549
				4 Flutes Corner Radius, Variable Helix		SP210-R4	D3 ~ D16	273	549
				4 Flute Corner Radius, with Long Shank Length and Variable Helix		SP210-RH4	D4 ~ D12	275	549
				2 Flutes, Ballnose		SP210-B2	D1 ~ D12	276	550
				2 Flutes, Ballnose, with Long Shank Length		SP210-BH2	D4 ~ D12	277	550













































Most Suitable Suitable

Workpiece Material											
P		M	K	N			S		H		
1 2 3 4	5 6	1 2 3	1 2 3	1 2 3	4	5	1 2 3	4	1	2	3 4
Carbon Steel, Alloy	Alloy Steel	Stainless Steel	Cast Iron	Aluminium Alloys	Copper Alloys	Graphite, Composite Materials	Heat Resistant Super Alloys	Titanium Alloys	Hardened Steel	Hardened Steel	Hardened Steel
< 35HRC ≤ 48HRC									45-55HRC	55-60HRC	> 60HRC

	⊙	⊙	○	⊙							
	⊙	○	○	⊙	○	○					
	⊙	○	○	⊙	○	○					
	⊙	○	○	⊙	○	○					











































	⊙	⊙	○	⊙							
	⊙	⊙	○	⊙							
	⊙	⊙	○	⊙							
	⊙	⊙	○	⊙							
	⊙	⊙	○	⊙							
	⊙	⊙	○	⊙							
	⊙	⊙	○	⊙							
	⊙	⊙	○	⊙							
	⊙	⊙	○	⊙							

Endmill Catalog (by Series)

















































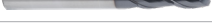

Suitable Material	No. of Flutes	End Teeth Type	Coating	Description	Type	Diameter Range	Dimension Page	Cutting Parameters Page	
PP300									
Steel Cast Iron				2 Flutes, Standard length (Tip Chamfer)		PP300-C2	D2 ~ D12	278	551
				3 Flutes, Standard length Variable Helix (Tip Chamfer)		PP300-C3	D3 ~ D20	279	552
				4 Flutes, Standard length Double Helix (Tip Chamfer)		PP300-C4	D3 ~ D20	280	553
				4 Flutes, Variable Helix with Chamfer		PP300-R4	D4 ~ D20	281	553
				4/5 Flutes, Variable Helix with Radius		PP300 -SPEED-3D	D6 ~ D20	283	554
									
				4/5 Flutes, Long Neck, Variable Helix with Radius		PP300 -SPEED-3DN	D6 ~ D20	284	554
									
				4/5 Flutes, Variable Helix with Radius		PP300 -SPEED-5D	D6 ~ D20	285	554
									
UPN210									
				4 Flutes, with Roughing Geometry		UPN210-S4	D6 ~ D20	286	556
UPR210									
				4 Flutes Square, with Roughing Geometry		UPR210-S4	D6 ~ D20	287	555
UPR300									
				3/4 Flutes Square, with Roughing Geometry		UPR300-S3/ S4	D6 ~ D20	288	557
									

 Most Suitable  Suitable

Workpiece Material												
P		M	K	N			S	H				
1 2 3 4	5 6	1 2 3	1 2 3	1 2 3	4	5	1 2 3	4	1	2	3 4	
Carbon Steel, Alloy	Alloy Steel	Stainless Steel	Cast Iron	Aluminium Alloys	Copper Alloys	Graphite, Composite Materials	Heat Resistant Super Alloys	Titanium Alloys	Hardened Steel	Hardened Steel	Hardened Steel	
< 35HRC ≤ 48HRC									45-55HRC	55-60HRC	> 60HRC	

Endmill Catalog (by Series)

Suitable Material	No. of Flutes	End Teeth Type	Coating	Description	Type	Diameter Range	Dimension Page	Cutting Parameters Page	
SPM200									
Steel Cast Iron Copper Alloys Hardened Steel				2 Flutes, Long Neck, Micro Diameter		SPM200-SN2	D0.1 ~ D6	477	589
				2 Flutes, Corner Radius, Long Neck, Micro Diameter		SPM200-RN2	D0.2 ~ D6	483	599
				4 Flutes, Corner Radius, Long Neck, Micro Diameter		SPM200-RN4	D1 ~ D6	497	621
				2 Flutes, Ballnose, Long Neck, Micro Diameter		SPM200-BN2	D0.1 ~ D6	503	626
US200									
Stainless Steel				2 Flutes, Standard Length		US200-S2	D0.5 ~ D20	289	559
				4 Flutes, Stub Length		US200-SS4	D2 ~ D20	290	560
				4 Flutes, Standard Length		US200-S4	D1 ~ D22	291	560
				4 Flutes, with Long Shank Length		US200-SN4	D2 ~ D20	292	560
				2 Flutes, Corner Radius		US200-R2	D3 ~ D16	293	559
				3 Flutes, Corner Radius		US200-R3	D2 ~ D20	294	559
				4 Flutes, Corner Radius		US200-R4	D2 ~ D20	295	560
				2 Flutes, Standard Length		US200-B2	D1 ~ D16	296	560
				4 Flutes, Standard Length		US200-B4	D1 ~ D20	297	560

 Most Suitable  Suitable

Workpiece Material												
P		M	K	N			S		H			
1 2 3 4	5 6	1 2 3	1 2 3	1 2 3	4	5	1 2 3	4	1	2	3 4	
Carbon Steel, Alloy	Alloy Steel	Stainless Steel	Cast Iron	Aluminium Alloys	Copper Alloys	Graphite, Composite Materials	Heat Resistant Super Alloys	Titanium Alloys	Hardened Steel	Hardened Steel	Hardened Steel	
< 35HRC ≤ 48HRC									45-55HRC	55-60HRC	> 60HRC	

	⊙	⊙	○	⊙	○	⊙		○	○	⊙		
	⊙	⊙	○	⊙	○	⊙		○	○	⊙		
	⊙	⊙	○	⊙	○	⊙		○	○	⊙		
	⊙	⊙	○	⊙	○	⊙		○	○	⊙		

	○	○	⊙	○				○	○			
	○	○	⊙	○				○	○			
	○	○	⊙	○				○	○			
	○	○	⊙	○				○	○			
	○	○	⊙	○				○	○			
	○	○	⊙	○				○	○			
	○	○	⊙	○				○	○			
	○	○	⊙	○				○	○			
	○	○	⊙	○				○	○			

Endmill Catalog (by Series)



























Suitable Material	No. of Flutes	End Teeth Type	Coating	Description	Type	Diameter Range	Dimension Page	Cutting Parameters Page
-------------------	---------------	----------------	---------	-------------	------	----------------	----------------	-------------------------

US260

		TiAlN	2 Flutes, Standard Length/Stub Length		US260-S2/SS2	D0.5 ~ D0.8	298	561
		TiAlN	4 Flutes, Stub Length		US260-SS4A	D1 ~ D20	299	561
		TiAlN	4 Flutes, Stub Length		US260-SS4B	D1 ~ D6	300	561
		TiAlN	4 Flutes, Standard Length		US260-S4A	D1 ~ D20	301	561
		TiAlN	4 Flutes, Standard Length		US260-S4B	D1 ~ D6	302	561
		TiAlN	4 Flutes, Corner Radius		US260-RS4	D1 ~ D20	303	562
		TiAlN	4 Flutes, Corner Radius		US260-R4	D1.5 ~ D20	304	562

SS600

Stainless Steel

		TiAlN	4 Flutes, Stub Length		SS600-SS4	D2 ~ D20	306	563
		TiAlN	4 Flutes, Standard Length		SS600-S4	D1 ~ D20	307	563
		TiAlN	4 Flutes, Long Shank		SS600-SH4	D2 ~ D20	308	563
		TiAlN	5 Flutes, Standard Length		SS600-S5	D6 ~ D25	309	563
		TiAlN	4 Flutes, Corner Radius, Reduced Flute		SS600-RS4	D2 ~ D20	310	563
		TiAlN	4 Flutes, Corner Radius		SS600-R4	D2 ~ D20	311	563
		TiAlN	4 Flutes, Corner Radius, Long Shank Length		SS600-RH4	D4 ~ D20	313	563
		TiAlN	5 Flutes, Corner Radius		SS600-R5	D6 ~ D25	315	563
		TiAlN	4 Flutes, Ballnose		SS600-B4	D2 ~ D20	319	563

 Most Suitable  Suitable

Workpiece Material												
P		M	K	N			S		H			
1 2 3 4	5 6	1 2 3	1 2 3	1 2 3	4	5	1 2 3	4	1	2	3 4	
Carbon Steel, Alloy	Alloy Steel	Stainless Steel	Cast Iron	Aluminium Alloys	Copper Alloys	Graphite, Composite Materials	Heat Resistant Super Alloys	Titanium Alloys	Hardened Steel	Hardened Steel	Hardened Steel	
< 35HRC	≤ 48HRC								45-55HRC	55-60HRC	> 60HRC	

































	○	○	⊙	○				○	○			
	○	○	⊙	○				○	○			
	○	○	⊙	○				○	○			
	○	○	⊙	○				○	○			
	○	○	⊙	○				○	○			
	○	○	⊙	○				○	○			
	○	○	⊙	○				○	○			
	○	○	⊙	○				○	○			

	⊙	⊙	⊙	○				○	⊙			
	⊙	⊙	⊙	○				○	⊙			
	⊙	⊙	⊙	○				○	⊙			
	⊙	⊙	⊙	○				○	⊙			
	⊙	⊙	⊙	○				○	⊙			
	⊙	⊙	⊙	○				○	⊙			
	⊙	⊙	⊙	○				○	⊙			
	⊙	⊙	⊙	○				○	⊙			
	⊙	⊙	⊙	○				○	⊙			

Endmill Catalog (by Series)

Suitable Material	No. of Flutes	End Teeth Type	Coating	Description	Type	Diameter Range	Dimension Page	Cutting Parameters Page
-------------------	---------------	----------------	---------	-------------	------	----------------	----------------	-------------------------













UA100



Aluminium Alloys				2 Flutes, Standard Length 	UA100-S2	D1 ~ D20	320	564
				2 Flutes, with Long Flute Length 	UA100-SL2	D2 ~ D20	321	564
				2 Flutes, with Long Shank Length 	UA100-SH2	D2 ~ D20	322	564
				3 Flutes, Standard Length 	UA100-S3	D1 ~ D20	323	565
				3 Flutes, with Long Flute Length 	UA100-SL3	D2 ~ D20	324	565
				3 Flutes, with Long Shank Length 	UA100-SH3	D2 ~ D20	325	565
				2 Flutes, Corner Radius 	UA100-R2	D1 ~ D20	326	564
				2 Flutes Corner Radius, with Long Shank Length 	UA100-RH2	D6 ~ D20	329	564
				3 Flutes, Corner Radius 	UA100-R3	D1 ~ D20	331	565
				3 Flutes Corner Radius, with Long Shank Length 	UA100-RH3	D6 ~ D20	334	565
			2 Flutes, Ballnose 	UA100-B2	D1 ~ D16	336	566	

SA100

			3 Flutes, Standard Length 	SA100-S3	D3 ~ D12	337	566
---	---	--	---	----------	----------	-----	-----

SA160

			3 Flutes, Standard Length 	SA160-S3	D4 ~ D20	338	566
			3 Flutes, Long Flute Length 	SA160-SL3	D4 ~ D20	339	566
			4 Flutes, Standard Length 	SA160-S4	D4 ~ D20	340	566
			4 Flutes, Stub Length 	SA160-SS4	D4 ~ D20	341	566

 Most Suitable  Suitable

Endmill Catalog (by Series)

Suitable Material	No. of Flutes	End Teeth Type	Coating	Description	Type	Diameter Range	Dimension Page	Cutting Parameters Page	
SA210									
				3 Flutes Corner Radius, with Long Neck NEW	SA210-WR	D12 ~ D25	342	567	
				3 Flutes, Conner Radius, Long Neck (Internal Cooling with Coating) NEW	SA210-WR-IC	D12 ~ D25	345	567	
				3 Flutes Corner Radius, with Long Neck	SA210-NR	D6 ~ D20	348	567	
SA300									
Aluminium Alloys				3 Flutes, Standard Length	SA300-S3	D6 ~ D20	349	568	
				2 Flutes, Corner Radius, Long Neck	SA300-RN2	D6 ~ D32	350	568	
				3 Flutes, Corner Radius, Long Neck	SA300-RN3	D6 ~ D32	354	568	
				2 Flutes, Ballnose, Long Neck	SA300-BN2	D6 ~ D20	358	568	
				4 Flutes, Long Neck NEW	SA300-SF-SN4	D6 ~ D20	359	569	
				4 Flutes, Long Neck (Internal Cooling with Coating) NEW	SA300-SF-IC-SN4	D12 ~ D20	360	569	
				4 Flutes, Conner Radius, Long Neck NEW	SA300-SF-RN4	D10 ~ D20	361	569	
				4 Flutes, Conner Radius, Long Neck (Internal Cooling with Coating) NEW	SA300-SF-IC-RN4	D12 ~ D20	363	569	
				6 Flutes, Conner Radius, Long Neck NEW	SA300-WF-RN6	D16 ~ D25	365	569	
				6 Flutes, Conner Radius, Long Neck (Internal Cooling with Coating) NEW	SA300-WF-IC-RN6	D16 ~ D25	366	569	
DNM100									
Copper-Aluminium Graphite Composite				1 Flute, Corner Radius	DNM100-RS1	D2 ~ D3	367	569	
				2 Flutes, Corner Radius	DNM100-RS2	D4 ~ D10	368	569	
				3 Flutes, Corner Radius	DNM100-RS3	D10 ~ D16	369	569	

Most Suitable Suitable

Workpiece Material												
P		M	K	N			S	H				
1 2 3 4	5 6	1 2 3	1 2 3	1 2 3	4	5	1 2 3	4	1	2	3 4	
Carbon Steel, Alloy	Alloy Steel	Stainless Steel	Cast Iron	Aluminium Alloys	Copper Alloys	Graphite, Composite Materials	Heat Resistant Super Alloys	Titanium Alloys	Hardened Steel	Hardened Steel	Hardened Steel	
< 35HRC ≤ 48HRC									45-55HRC	55-60HRC	> 60HRC	

					○							
					○							
					○	○						

					○							
					○							
					○							
					○							
					○							
					○							
					○							
					○							
					○							

					○	○	○					
					○	○	○					
					○	○	○					

Endmill Catalog (by Series)

Suitable Material	No. of Flutes	End Teeth Type	Coating	Description	Type	Diameter Range	Dimension Page	Cutting Parameters Page
-------------------	---------------	----------------	---------	-------------	------	----------------	----------------	-------------------------















SG200

Graphite			U-DIA	2 Flutes, Standard Length		SG200-S2	D0.4 ~ D12	370	570
			U-DIA	2 Flutes, with Long Neck		SG200-SN2	D1 ~ D12	371	570
			U-DIA	3 Flutes, Standard Length		SG200-S3	D1 ~ D12	372	570
			U-DIA	4 Flutes, Standard Length		SG200-S4	D2 ~ D12	373	570
			U-DIA	4 Flutes, Corner Radius		SG200-R4	D2 ~ D12	374	570
			U-DIA	4 Flutes, Corner Radius With Long Neck		SG200-RN4	D2 ~ D12	375	570
			U-DIA	2 Flutes, Ballnose		SG200-B2	D0.5 ~ D12	376	571
			U-DIA	2 Flutes, Ballnose, With Long Neck		SG200-BN2	D0.5 ~ D12	377	571

SG200-M

			N-DIA	4 Flutes, Corner Radius, With Long Neck		SG200-M-RN4	D1 ~ D10	379	571
			N-DIA	2 Flutes, Ballnose		SG200-M-B2	D0.4 ~ D6	380	571
			N-DIA	2 Flutes, Ballnose, With Long Neck		SG200-M-BN2	D0.5 ~ D6	381	571

ST210





































Titanium Alloys			AICrN	4 Flutes, Standard Length		ST210-S4	D1 ~ D20	382	572
			AICrN	4 Flutes, Corner Radius		ST210-R4	D2 ~ D20	383	572
			AICrN	4 Flutes, Corner Radius With Long Neck		ST210-RN4	D6 ~ D20	385	572
			AICrSiN	5 Flutes, Long Flute Length With Corner Radius		ST210-RL5	D16 ~ D25	388	573
			AICrSiN	4 Flutes, Ballnose		ST210-B4	D2 ~ D20	389	573

Most Suitable
 Suitable

Workpiece Material												
P		M	K	N			S		H			
1 2 3 4	5 6	1 2 3	1 2 3	1 2 3	4	5	1 2 3	4	1	2	3 4	
Carbon Steel, Alloy	Alloy Steel	Stainless Steel	Cast Iron	Aluminium Alloys	Copper Alloys	Graphite, Composite Materials	Heat Resistant Super Alloys	Titanium Alloys	Hardened Steel	Hardened Steel	Hardened Steel	
< 35HRC ≤ 48HRC									45-55HRC	55-60HRC	> 60HRC	

					○	○	◎					
					○	○	◎					
					○	○	◎					
					○	○	◎					
					○	○	◎					
					○	○	◎					
					○	○	◎					
					○	○	◎					
							◎					
							◎					
							◎					
		○	○	○					◎			
		○	○	○					◎			
	○	○	○						◎			
	○	○	○						◎			
	○	○	○						◎			

Endmill Catalog (by Series)

Suitable Material	No. of Flutes	End Teeth Type	Coating	Description	Type	Diameter Range	Dimension Page	Cutting Parameters Page	
SM200									
Zirconia Titanium Alloy			AlCrN	2 Flutes, Ballnose, Long Neck		SM200-TP2	R0.5 ~ R1.5	390	574
			N-DIA	2 Flutes/ 3 Flutes, Ballnose, Long Neck		SM200-RO2/RO3	R0.3 ~ R1.5	391	574
			N-DIA	2 Flutes/ 3 Flutes, Ballnose, Long Neck		SM200-VH2/VH3	R0.3 ~ R1	392	574
			N-DIA	2 Flutes/ 3 Flutes, Ballnose, Long Neck		SM200-WI2/WI3	R0.3 ~ R1.25	393	574
			N-DIA	2 Flutes/ 3 Flutes, Ballnose, Long Neck		SM200-IM2/IM3	R0.3 ~ R1.25	394	574
			N-DIA	2 Flutes/ 3 Flutes, Ballnose, Long Neck		SM200-ZI2/ZI3	R0.25 ~ R1.5	396	574
			AlCrN	2 Flutes/ 3 Flutes, Ballnose, Long Neck		SM200-ZI2/ZI3	R0.25 ~ R1.5	396	574
			N-DIA	2 Flutes/ 3 Flutes, Ballnose, Long Neck		SM200-AR2/AR3	R0.3 ~ R1.5	398	575
			AlCrN	2 Flutes/ 3 Flutes, Ballnose, Long Neck		SM200-AR2/AR3	R0.3 ~ R1.5	398	575
			N-DIA	2 Flutes, Ballnose, Long Neck		SM200-KL2	R0.3 ~ R1	400	574
			N-DIA	2 Flutes, Ballnose, Long Neck		SM200-XT2	R0.3 ~ R1.5	401	575
			AlCrN	2 Flutes, Ballnose, Long Neck		SM200-XT2	R0.3 ~ R1.5	401	575

 Most Suitable  Suitable

Workpiece Material											
P		M	K	N			S		H		
1 2 3 4	5 6	1 2 3	1 2 3	1 2 3	4	5	1 2 3	4	1	2	3 4
Carbon Steel, Alloy	Alloy Steel	Stainless Steel	Cast Iron	Aluminium Alloys	Copper Alloys	Graphite, Composite Materials	Heat Resistant Super Alloys	Titanium Alloys	Hardened Steel	Hardened Steel	Hardened Steel
< 35HRC	≤ 48HRC								45-55HRC	55-60HRC	> 60HRC

									⊙			
								⊙				
								⊙				
								⊙				
								⊙				
								⊙		⊙		
								⊙		⊙		
								⊙				
								⊙		⊙		

Endmill Catalog (by Series)

Suitable Material	No. of Flutes	End Teeth Type	Coating	Description	Type	Diameter Range	Dimension Page	Cutting Parameters Page	
SN200									
Heat Resistant Super Alloys	4	Corner-R	TiAlN	4 Flutes, Corner Radius		SN200-R4	D1 ~ D20	403	576
	4	Corner-R	TiAlN	4 Flutes, Corner Radius With Long Shank Length		SN200-RH4	D8 ~ D16	406	576
	4	Ballnose	TiAlN	4 Flutes, Ballnose		SN200-B4	D2 ~ D12	407	577
	4	Ballnose	TiAlN	4 Flutes, Ballnose With Long Shank Length		SN200-BH4	D8 ~ D12	408	577
SD200									
Composite Materials	8	Square	U-DIA	12 Flutes, Rhombic Teeth		SD200-CN	D2 ~ D12	409	578
	12								
SH160									
Hardened Steel	2	Square	TiAlN	2 Flutes, Standard Length		SH160-S2	D0.5 ~ D20	410	579
	4	Square	TiAlN	4 Flutes, Standard Length		SH160-S4	D1 ~ D20	412	579
	4	Square	TiAlN	4 Flutes, Long Shank		SH160-SH4	D3 ~ D12	414	579
	6	Square	TiAlN	6 Flutes, Standard Length		SH160-S6	D6 ~ D20	415	579
	2	Corner-R	TiAlN	2 Flutes, Conner Radius		SH160-R2	D2 ~ D12	416	579
	4	Corner-R	TiAlN	4 Flutes, Conner Radius		SH160-R4	D1 ~ D12	418	579
	4	Corner-R	TiAlN	4 Flutes, Corner Radius, Long Shank Length		SH160-RH4	D4 ~ D12	421	579
	2	Corner-R	TiAlN	2 Flutes, Ballnose		SH160-B2	D0.5 ~ D20	422	579
	2	Ballnose	TiAlN	2 Flutes Ballnose, with Long Shank Length		SH160-BH2	D4 ~ D12	424	579
	4	Ballnose	TiAlN	4 Flutes, Ballnose		SH160-B4	D2 ~ D16	425	579

Most Suitable
 Suitable

Workpiece Material											
P		M	K	N			S		H		
1 2 3 4	5 6	1 2 3	1 2 3	1 2 3	4	5	1 2 3	4	1	2	3 4
Carbon Steel, Alloy	Alloy Steel	Stainless Steel	Cast Iron	Aluminium Alloys	Copper Alloys	Graphite, Composite Materials	Heat Resistant Super Alloys	Titanium Alloys	Hardened Steel	Hardened Steel	Hardened Steel
< 35HRC	≤ 48HRC								45-55HRC	55-60HRC	> 60HRC

	○	○	○					◎	○		
	○	○	○					◎	○		
	○	○	○					◎	○		
	○	○	○					◎	○		

































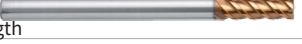











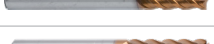



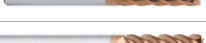

							◎				
--	--	--	--	--	--	--	---	--	--	--	--

									◎		
									◎		
									◎		
									◎		
									◎		
									◎		
									◎		
									◎		
									◎		
									◎		

Endmill Catalog (by Series)

Suitable Material	No. of Flutes	End Teeth Type	Coating	Description	Type	Diameter Range	Dimension Page	Cutting Parameters Page
-------------------	---------------	----------------	---------	-------------	------	----------------	----------------	-------------------------

SH260-H

Hardened Steel				2 Flutes, Standard Length 	SH260-S2-H	D1 ~ D12	426	580
				2 Flutes, Standard With Long Neck 	SH260-SN2-H	D1 ~ D6	427	580
				4 Flute, Standard Length 	SH260-S4-H	D1 ~ D20	429	581
				4 Flutes, 45° Helix 	SH260-S4A-H	D1 ~ D20	430	581
				4 Flutes, with Long Shank Length 	SH260-SH4-H	D1 ~ D20	431	581
				4 Flutes, 45° Helix, Long Shank Length 	SH260-SH4A-H	D3-D20	432	581
				4 Flutes, Standard End With Long Neck 	SH260-SN4-H	D1 ~ D12	433	581
				4 Flutes, Long Flute Length 	SH260-SL4-H	D1 ~ D16	434	581
				4 Flutes, 45° Helix, Long Flute Length 	SH260-SL4A-H	D4-D20	435	581
				6 Flutes, Standard Length 	SH260-S6-H	D6 ~ D20	436	581
				6 Flutes, Long Shank Length 	SH260-SH6-H	D6 ~ D20	437	581
				6 Flutes, Long Flute Length 	SH260-SL6-H	D6 ~ D20	438	581
				2 Flutes, Corner Radius 	SH260-R2-H	D1 ~ D8	439	580

 Most Suitable  Suitable

Workpiece Material											
P		M	K	N			S	H			
1 2 3 4	5 6	1 2 3	1 2 3	1 2 3	4	5	1 2 3	4	1	2	3 4
Carbon Steel, Alloy	Alloy Steel	Stainless Steel	Cast Iron	Aluminium Alloys	Copper Alloys	Graphite, Composite Materials	Heat Resistant Super Alloys	Titanium Alloys	Hardened Steel	Hardened Steel	Hardened Steel
< 35HRC	≤ 48HRC								45-55HRC	55-60HRC	> 60HRC

	○	◎							◎	◎	○
	○	◎							◎	◎	○
	○	◎							◎	◎	○
	○	◎							◎	◎	○
	○	◎							◎	◎	○
	○	◎							◎	◎	○
	○	◎							◎	◎	○
	○	◎							◎	◎	○
	○	◎							◎	◎	○
	○	◎							◎	◎	○
	○	◎							◎	◎	○
	○	◎							◎	◎	○
	○	◎							◎	◎	○
	○	◎							◎	◎	○
	○	◎							◎	◎	○

Endmill Catalog (by Series)

Suitable Material	No. of Flutes	End Teeth Type	Coating	Description	Type	Diameter Range	Dimension Page	Cutting Parameters Page
-------------------	---------------	----------------	---------	-------------	------	----------------	----------------	-------------------------

SH260-H

Hardened Steel				2 Flutes, Corner Radius, with Long Neck	SH260-RN2-H	D0.8 ~ D6	440	580
				4 Flutes, Corner Radius	SH260-R4-H	D1 ~ D12	442	581
				4 Flutes, Corner Radius, 45° Helix	SH260-R4A-H	D1-D12	445	581
				4 Flutes, Corner Radius, with Long Shank Length	SH260-RH4-H	D2 ~ D12	447	581
				4 Flutes, Corner Radius, with Long Flute Length	SH260-RH4A-H	D4-D12	449	581
				4 Flutes, Corner Radius, 45° Helix, with Long Shank Length	SH260-RL4A-H	D6-D12	451	581
				4 Flutes, Corner Radius, with Long Neck	SH260-RN4-H	D1 ~ D12	452	581
				2 Flutes, Ballnose	SH260-B2-H	D1 ~ D16	454	582
				2 Flutes, Ballnose, with Long Shank Length	SH260-BH2-H	D2 ~ D12	455	582
				2 Flutes, Ballnose, with Long Neck	SH260-BN2-H	D1 ~ D12	457	582

SH360

				2 Flutes, Standard Length	SH360-S2	D1-D12	459	583
				4 Flutes, 45° Helix	SH360-S4A	D1-D20	460	584
				4 Flutes, 45° Helix, Long Shank Length	SH360-SH4A	D1-D20	461	584
				6 Flutes, Standard Length	SH360-S6	D6-D20	462	584

Most Suitable Suitable

Workpiece Material											
P		M	K	N			S	H			
1 2 3 4	5 6	1 2 3	1 2 3	1 2 3	4	5	1 2 3	4	1	2	3 4
Carbon Steel, Alloy	Alloy Steel	Stainless Steel	Cast Iron	Aluminium Alloys	Copper Alloys	Graphite, Composite Materials	Heat Resistant Super Alloys	Titanium Alloys	Hardened Steel	Hardened Steel	Hardened Steel
< 35HRC		≤ 48HRC							45-55HRC	55-60HRC	> 60HRC



















	○	◎							◎	◎	○
	○	◎							◎	◎	○
	○	◎							◎	◎	○
	○	◎							◎	◎	○
	○	◎							◎	◎	○
	○	◎							◎	◎	○
	○	◎							◎	◎	○
	○	◎							◎	◎	○
	○	◎							◎	◎	○
	○	◎							◎	◎	○

		○							○	◎	◎
		○							○	◎	◎
		○							○	◎	◎
		○							○	◎	◎



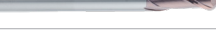

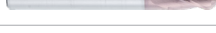

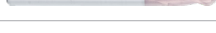





Endmill Catalog (by Series)

Suitable Material	No. of Flutes	End Teeth Type	Coating	Description	Type	Diameter Range	Dimension Page	Cutting Parameters Page
-------------------	---------------	----------------	---------	-------------	------	----------------	----------------	-------------------------





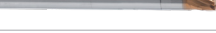

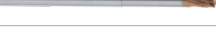



SH360

		TIAIC/SIN	6 Flutes, Long Flute Length		SH360-SL6	D6-D20	463	584
		TIAIC/SIN	4 Flutes, Corner Radius		SH360-R4	D1-D12	464	584
		TIAIC/SIN	4 Flutes, Corner Radius, Long Shank Length		SH360-RH4	D4-D12	466	584
		TIAIC/SIN	2 Flutes, Ballnose		SH360-B2	D0.6-D20	467	585
		TIAIC/SIN	2 Flutes, Ballnose, Long Shank Length		SH360-BH2	D4-D20	468	585
		TIAIC/SIN	4 Flutes, Ballnose		SH360-B4	D3-D16	469	586
		TIAIC/SIN	4 Flutes, Ballnose, Long Shank Length		SH360-BH4	D3-D16	470	586

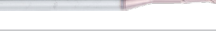
FH200-H

Hardened Steel			TIAIC/SIN	4 Flutes, Corner Radius		FH200-R4-H	D1 ~ D12	471	587
			TIAIC/SIN	4 Flutes, Corner Radius, Long Neck		FH200-RN4-H	D8 ~ D12	473	587
			TIAIC/SIN	6 Flutes, Corner Radius		FH200-R6-H	D6~D20	474	587
			TIAIC/SIN	6 Flutes, Corner Radius, Long Shank Length		FH200-RH6-H	D6~D20	475	587
			TIAIC/SIN	6 Flutes, Corner radius, Long Neck		FH200-RN6-H	D6~D20	476	587

SHM200

		TIAIC/SIN	2 Flutes, Long Neck, Micro Diameter		SHM200-SN2	D0.1-D6.0	511	589
		TIAIC/SIN	2 Flutes, Corner Radius, Long Neck, Micro Diameter		SHM200-RN2	D0.2-D6.0	517	599
		TIAIC/SIN	4 Flutes, Corner Radius, Long Neck, Micro Diameter		SHM200-RN4	D1-D6.0	531	621
		TIAIC/SIN	2 Flutes, Ballnose, Long Neck, Micro Diameter		SHM200-BN2	D0.1-D6.0	537	626

 Most Suitable  Suitable



















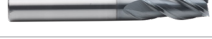

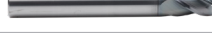















Workpiece Material												
P		M	K	N			S		H			
1 2 3 4	5 6	1 2 3	1 2 3	1 2 3	4	5	1 2 3	4	1	2	3 4	
Carbon Steel, Alloy	Alloy Steel	Stainless Steel	Cast Iron	Aluminium Alloys	Copper Alloys	Graphite, Composite Materials	Heat Resistant Super Alloys	Titanium Alloys	Hardened Steel	Hardened Steel	Hardened Steel	
< 35HRC ≤ 48HRC									45-55HRC	55-60HRC	> 60HRC	

		○								○	⊙	⊙
		○								○	⊙	⊙
		○								○	⊙	⊙
		○								○	⊙	⊙
		○								○	⊙	⊙
		○								○	⊙	⊙
		○								○	⊙	⊙
		○								○	⊙	⊙

		⊙								⊙	⊙	⊙
		⊙								⊙	⊙	⊙
		⊙								⊙	⊙	⊙
		⊙								⊙	⊙	⊙
		⊙								⊙	⊙	⊙















































		○								○	⊙	⊙
		○								○	⊙	⊙
		○								○	⊙	⊙
		○								○	⊙	⊙

Endmill Catalog (by Type)

No. of Flutes	Coating	Description	Type	Diameter Range	Dimension Page	Cutting Parameters Page
Square						
	AlCrSiN	2 Flutes, Stub Length		UP210-SS2	D1 ~ D16	232 544
	AlCrSiN	2 Flutes, Standard Length		UP210-S2	D1 ~ D20	233 544
	AlCrSiN	2 Flutes, Long Flute Length		UP210-SL2	D2 ~ D20	235 544
	AlCrSiN	2 Flutes, Long Shank Length		UP210-SH2	D2 ~ D20	236 544
	AlCrSiN	3 Flutes, Standard Length		UP210-S3	D2 ~ D25	237 544
	AlCrSiN	4 Flutes, Stub Length		UP210-SS4	D1 ~ D20	238 545
	AlCrSiN	4 Flutes, Standard Length		UP210-S4	D1 ~ D22	239 545
	AlCrSiN	4 Flutes, Long Flute Length		UP210-SL4	D1 ~ D20	241 545
	AlCrSiN	4 Flutes, Long Shank Length		UP210-SH4	D2 ~ D20	243 545
	AlCrSiN	4 Flutes, Acute Angle		UP210-SC4	D4 ~ D20	244 545
	AlCrSiN	4 Flutes, 45° Helix		UP210-S4A	D4 ~ D20	245 545
	AlCrSiN	6 Flutes, Standard Length		UP210-S6	D6 ~ D20	246 545
	AlCrSiN	3 Flutes, Variable Helix		SP210-S3	D2.5 ~ D20	267 548
	AlCrSiN	3 Flutes, Variable Helix with Chamfer		SP210-C3	D6 ~ D20	268 548
	AlCrSiN	4 Flutes, Variable Helix		SP210-S4	D2 ~ D20	269 549
	AlCrN	4 Flutes, Variable Helix with Chamfer		SP210-C4	D3 ~ D25	270 549
	AlCrN	4 Flutes, Long Neck, Variable Helix with Chamfer		SP210-CN4	D3 ~ D20	272 549
	AlCrSiN	2 Flutes, Square with Chamfer		PP300-C2	D2 ~ D12	278 551
	AlCrSiN	3 Flutes, Variable Helix with Chamfer		PP300-C3	D3 ~ D20	279 552

 Most Suitable  Suitable

Endmill Catalog (by Type)

No. of Flutes	Coating	Description	Type	Diameter Range	Dimension Page	Cutting Parameters Page
Square						
		4 Flutes, Variable Helix with Chamfer 	PP300-C4	D3 ~ D20	280	553
		4/5 Flutes, Variable Helix with Radius 	PP300-SPEED-3D	D6 ~ D20	283	554
						
		4/5 Flutes, Long Neck, Variable Helix with Radius 	PP300-SPEED-3DN	D6 ~ D20	284	554
						
		4/5 Flutes, Variable Helix with Radius 	PP300-SPEED-5D	D6 ~ D20	285	554
						
		4 Flutes, Roughing Geometry 	UPN210-S4	D6 ~ D20	286	556
		4 Flutes, Roughing Geometry 	UPR210-S4	D6 ~ D20	287	555
		3/4 Flutes, Roughing Geometry 	UPR300-S3/S4	D6 ~ D20	289	559
						
		2 Flutes, Long Neck, Micro Diameter 	SPM200-SN2	D0.1 ~ D6	291	560
		2 Flutes, Long Neck, Micro Diameter 	SHM200-SN2	D0.1 ~ D6	292	560
		2 Flutes, Standard Length 	US200-S2	D0.5 ~ D20	298	561
		4 Flutes, Stub Length 	US200-SS4	D2 ~ D20	282	552
		4 Flutes, Standard Length 	US200-S4	D1 ~ D20	283	552
		4 Flutes, Long Neck 	US200-SN4	D2 ~ D12	284	552
		2 Flutes, Standard Length/Stub Length 	US260-S2/SS2	D0.5 ~ D0.8	290	553

 Most Suitable  Suitable

Workpiece Material											
P		M	K	N			S		H		
1 2 3 4	5 6	1 2 3	1 2 3	1 2 3	4	5	1 2 3	4	1	2	3 4
Carbon Steel, Alloy	Alloy Steel	Stainless Steel	Cast Iron	Aluminium Alloys	Copper Alloys	Graphite, Composite Materials	Heat Resistant Super Alloys	Titanium Alloys	Hardened Steel	Hardened Steel	Hardened Steel
< 35HRC	≤ 48HRC								45-55HRC	55-60HRC	> 60HRC
○	○	○	○								
○	○	○	○								
○	○	○	○								
○	○	○	○								
○	○	○	○						○		
○	○	○	○								
○	○	○	○						○		
○	○	○	○	○	○		○	○	○		
	○								○	○	○
○	○	○	○				○	○			
○	○	○	○				○	○			
○	○	○	○				○	○			
○	○	○	○				○	○			
○	○	○	○				○	○			



















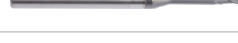

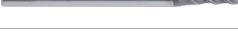







Endmill Catalog (by Type)

No. of Flutes	Coating	Description	Type	Diameter Range	Dimension Page	Cutting Parameters Page
Square						
	TiAlN	4 Flutes, Stub Length		US260-SS4A	D1 ~ D20	299 561
	TiAlN	4 Flutes, Stub Length		US260-SS4B	D1 ~ D6	300 561
	TiAlN	4 Flutes, Standard Length		US260-S4A	D1 ~ D20	301 561
	TiAlN	4 Flutes, Standard Length		US260-S4B	D1 ~ D6	302 561
	TiAlN	4 Flutes, Stub Length		SS600-SS4	D2 ~ D20	306 563
	TiAlN	4 Flutes, Standard Length		SS600-S4	D1 ~ D20	307 563
	TiAlN	4 Flutes, Long Shank Length		SS600-SH4	D2 ~ D20	308 563
	TiAlN	5 Flutes, Standard Length		SS600-S5	D6 ~ D25	309 563
		2 Flutes, Standard Length		UA100-S2	D1 ~ D12	320 564
		2 Flutes, Long Flute Length		UA100-SL2	D2 ~ D12	321 564
		2 Flutes, Long Shank Length		UA100-SH2	D2 ~ D12	322 564
		3 Flutes, Standard Length		UA100-S3	D2 ~ D20	323 565
		3 Flutes, Long Flute Length		UA100-SL3	D2 ~ D20	324 565
		3 Flutes, Long Shank Length		UA100-SH3	D2 ~ D20	325 565
		3 Flutes, Standard Length		SA100-S3	D3 ~ D12	337 566
		3 Flutes, Standard Length NEW		SA160-S3	D4 ~ D20	338 566
		3 Flutes, Long Flute Length NEW		SA160-SL3	D4 ~ D20	339 566
		4 Flutes, Standard Length NEW		SA160-S4	D4 ~ D20	340 566
		4 Flutes, Stub Length NEW		SA160-SS4	D4 ~ D20	341 566

Most Suitable Suitable

	Workpiece Material											
	P		M	K	N			S		H		
	1 2 3 4	5 6	1 2 3	1 2 3	1 2 3	4	5	1 2 3	4	1	2	3 4
	Carbon Steel, Alloy	Alloy Steel	Stainless Steel	Cast Iron	Aluminium Alloys	Copper Alloys	Graphite, Composite Materials	Heat Resistant Super Alloys	Titanium Alloys	Hardened Steel	Hardened Steel	Hardened Steel
	< 35HRC	≤ 48HRC								45-55HRC	55-60HRC	> 60HRC
	○	○	⊙	○				○	○			
	○	○	⊙	○				○	○			
	○	○	⊙	○				○	○			
	○	○	⊙	○				○	○			
	⊙	⊙	⊙	○				○	⊙			
	⊙	⊙	⊙	○				○	⊙			
	⊙	⊙	⊙	○				○	⊙			
	⊙	⊙	⊙	○				○	⊙			
					⊙	⊙						
					⊙	⊙						
					⊙	⊙						
					⊙	⊙						
					⊙	⊙						
					⊙	⊙						
					⊙							
					⊙							
					⊙							
					⊙							
					⊙							
					⊙							
					⊙							
					⊙							
					⊙							







































Endmill Catalog (by Type)

No. of Flutes	Coating	Description	Type	Diameter Range	Dimension Page	Cutting Parameters Page
Square						
		3 Flutes, Standard Length 	SA300-S3	D6 ~ D20	349	568
		4 Flutes, Long Neck 	SA300-SF-SN4	D6 ~ D20	359	569
	Titanium-rich	4 Flutes, Long Neck (Internal Cooling with Coating) 	SA300-SF-IC-SN4	D12 ~ D20	360	569
	U-DIA	2 Flutes, Standard Length 	SG200-S2	D0.4 ~ D12	370	570
	U-DIA	2 Flutes, Long Neck 	SG200-SN2	D1 ~ D12	371	570
	U-DIA	3 Flutes, Standard Length 	SG200-S3	D1 ~ D12	372	570
	U-DIA	4 Flutes, Standard Length 	SG200-S4	D2 ~ D12	373	570
	AlCrN	4 Flutes Square with Unequal Tooth Pitch 	ST210-S4	D1 ~ D20	382	572
	TiAlN	2 Flutes, Standard Length 	SH160-S2	D0.5 ~ D20	410	579
	TiAlN	4 Flutes, Standard Length 	SH160-S4	D1 ~ D20	412	579
	TiAlN	4 Flutes, Long Shank Length 	SH160-SH4	D3 ~ D12	414	579
	TiAlN	6 Flutes, Standard Length 	SH160-S6	D6 ~ D20	415	579
	TiAlC/SiN	2 Flutes, Standard Length 	SH260-S2-H	D1 ~ D12	426	580
	TiAlC/SiN	2 Flutes, Long Neck 	SH260-SN2-H	D1 ~ D6	427	580
	TiAlC/SiN	4 Flutes, Standard Length 	SH260-S4-H	D1 ~ D20	429	581

 Most Suitable  Suitable

Workpiece Material											
P		M	K	N			S	H			
1234	56	123	123	123	4	5	123	4	1	2	34
Carbon Steel, Alloy	Alloy Steel	Stainless Steel	Cast Iron	Aluminium Alloys	Copper Alloys	Graphite, Composite Materials	Heat Resistant Super Alloys	Titanium Alloys	Hardened Steel	Hardened Steel	Hardened Steel
< 35HRC	≤ 48HRC								45-55HRC	55-60HRC	> 60HRC
				⊙							
				⊙							
				⊙							
				⊙	⊙	⊙					
				⊙	⊙	⊙					
				⊙	⊙	⊙					
				⊙	⊙	⊙					
	⊙	⊙	⊙					⊙			
									⊙		
									⊙		
									⊙		
									⊙		
									⊙		
	⊙	⊙							⊙	⊙	⊙
	⊙	⊙							⊙	⊙	⊙
	⊙	⊙							⊙	⊙	⊙

























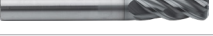



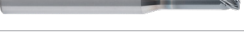



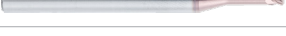

Endmill Catalog (by Type)

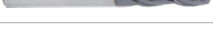
No. of Flutes	Coating	Description	Type	Diameter Range	Dimension Page	Cutting Parameters Page
Square						
		4 Flutes, 45° Helix 	SH260-S4A-H	D1 ~ D20	430	581
		4 Flutes, Long Shank Length 	SH260-SH4-H	D1 ~ D20	431	581
		4 Flutes, 45° Helix, Long Shank Length 	SH260-SH4A-H	D3 ~ D20	432	581
		4 Flutes, Long Neck 	SH260-SN4-H	D1 ~ D12	433	581
		4 Flutes, Long Flute Length 	SH260-SL4-H	D1 ~ D16	434	581
		4 Flutes, 45° Helix, Long Flute Length 	SH260-SL4A-H	D4 ~ D20	435	581
		6 Flutes, Standard Length 	SH260-S6-H	D6 ~ D20	436	581
		6 Flutes, Long Shank Length 	SH260-SH6-H	D6 ~ D20	437	581
		6 Flutes, Long Flute Length 	SH260-SL6-H	D6 ~ D20	438	581
		2 Flutes, Standard Length 	SH360-S2	D1-D12	459	583
		4 Flutes, 45° Helix 	SH360-S4A	D1-D20	460	584
		4 Flutes, 45° Helix Long Shank Length 	SH360-SH4A	D1-D20	461	584
		6 Flutes, Standard Length 	SH360-S6	D6-D20	462	584
		6 Flutes, Long Flute Length 	SH360-SL6	D6-D20	463	584

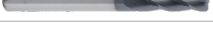
 Most Suitable  Suitable

Workpiece Material											
P		M	K	N			S	H			
1 2 3 4	5 6	1 2 3	1 2 3	1 2 3	4	5	1 2 3	4	1	2	3 4
Carbon Steel, Alloy	Alloy Steel	Stainless Steel	Cast Iron	Aluminium Alloys	Copper Alloys	Graphite, Composite Materials	Heat Resistant Super Alloys	Titanium Alloys	Hardened Steel	Hardened Steel	Hardened Steel
< 35HRC	≤ 48HRC								45-55HRC	55-60HRC	> 60HRC
	○	◎							◎	◎	○
	○	◎							◎	◎	○
	○	◎							◎	◎	○
	○	◎							◎	◎	○
	○	◎							◎	◎	○
	○	◎							◎	◎	○
	○	◎							◎	◎	○
	○	◎							◎	◎	○
	○	◎							◎	◎	○
		○							○	◎	◎
		○							○	◎	◎
		○							○	◎	◎
		○							○	◎	◎
		○							○	◎	◎
		○							○	◎	◎































Endmill Catalog (by Type)

No. of Flutes	Coating	Description	Type	Diameter Range	Dimension Page	Cutting Parameters Page
Corner Radius						
	AICrSiN	2 Flutes, Corner Radius		UP210-R2	D1 ~ D20	247 544
	AICrSiN	2 Flutes, Corner Radius, Long Shank Length		UP210-RH2	D4 ~ D20	250 544
	AICrSiN	4 Flutes, Corner Radius		UP210-R4	D1 ~ D20	252 545
	AICrSiN	4 Flutes, Corner Radius, Long Shank Length		UP210-RH4	D3 ~ D20	255 545
	AICrSiN	4 Flutes, Corner Radius, 45 ° Helix		UP210-R4A	D4 ~ D20	257 545
	AICrSiN	4 Flutes, Corner Radius, with Variable Helix		SP210-R4	D3 ~ D16	273 549
	AICrSiN	4 Flutes, Corner Radius, with Long Shank Length and Variable Helix		SP210-RH4	D4 ~ D12	275 549
	AICrSiN	4 Flutes, Corner Radius, Variable Helix		PP300-R4	D4 ~ D20	281 553
	AICrSiN	2 Flutes, Corner Radius, Long Neck, Micro Diameter		SPM200-RN2	D0.2 ~ D6	483 599
	AICrSiN	4 Flutes, Corner Radius, Long Neck, Micro Diameter		SPM200-RN4	D1 ~ D6	497 621
	TiAlSiN	2 Flutes, Corner Radius, Long Neck, Micro Diameter		SHM200-RN2	D0.2 ~ D6.0	517 599
	TiAlSiN	4 Flutes, Corner Radius, Long Neck, Micro Diameter		SHM200-RN4	D1 ~ D6.0	531 621
	TiAlN	2 Flutes, Corner Radius		US200-R2	D3 ~ D16	293 559
	TiAlN	3 Flutes, Corner Radius		US200-R3	D2 ~ D20	294 559
	TiAlN	4 Flutes, Corner Radius		US200-R4	D2 ~ D20	295 560
	TiAlN	4 Flutes, Corner Radius, Stub Length		US260-RS4	D1 ~ D20	303 562
	TiAlN	4 Flutes, Corner Radius		US260-R4	D1.5 ~ D20	304 562
	TiAlN	4 Flutes, Corner Radius, Stub Length		SS600-RS4	D2 ~ D20	310 563

 Most Suitable  Suitable

Workpiece Material												
P		M	K	N			S		H			
1 2 3 4	5 6	1 2 3	1 2 3	1 2 3	4	5	1 2 3	4	1	2	3 4	
Carbon Steel, Alloy	Alloy Steel	Stainless Steel	Cast Iron	Aluminium Alloys	Copper Alloys	Graphite, Composite Materials	Heat Resistant Super Alloys	Titanium Alloys	Hardened Steel	Hardened Steel	Hardened Steel	
< 35HRC	≤ 48HRC								45-55HRC	55-60HRC	> 60HRC	
⊙	⊙	○	⊙									
⊙	⊙	○	⊙									
⊙	⊙	○	⊙									
⊙	⊙	○	⊙									
⊙	⊙	○	⊙									
⊙	⊙	○	⊙									
⊙	⊙	○	⊙									
⊙	⊙	○	⊙									
⊙	⊙	○	⊙	○	⊙		○	○	⊙			
⊙	⊙	○	⊙	○	⊙		○	○	⊙			
	○								○	⊙	⊙	
	○								○	⊙	⊙	
○	○	⊙	○				○	○				
○	○	⊙	○				○	○				
○	○	⊙	○				○	○				
○	○	⊙	○				○	○				
○	○	⊙	○				○	○				
○	○	⊙	○				○	○				
○	○	⊙	○				○	○				
⊙	⊙	⊙	○				○	⊙				

















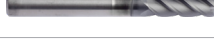

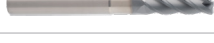











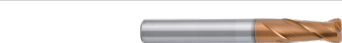

Endmill Catalog (by Type)

No. of Flutes	Coating	Description	Type	Diameter Range	Dimension Page	Cutting Parameters Page
Corner Radius						
		4 Flutes, Corner Radius		SS600-R4	D2 ~ D20	311 563
		4 Flutes, Corner Radius, Long Shank Length		SS600-RH4	D4 ~ D20	313 563
		5 Flutes, Corner Radius		SS600-R5	D6 ~ D25	315 563
		2 Flutes, Corner Radius		UA100-R2	D6 ~ D20	326 564
		2 Flutes, Corner Radius, Long Shank Length		UA100-RH2	D1 ~ D20	329 564
		3 Flutes, Corner Radius		UA100-R3	D1 ~ D20	331 565
		3 Flutes, Corner Radius, Long Shank Length		UA100-RH3	D1 ~ D20	334 565
		3 Flutes, Corner Radius, Long Neck		SA210-WR	D12 ~ D25	342 567
		3 Flutes, Corner radius, Long Neck (Internal cooling with coating)		SA210-WR-IC	D12 ~ D25	345 567
		3 Flutes, Corner Radius		SA210-NR	D6 ~ D20	348 567
		2 Flutes, Corner Radius, Long Neck		SA300-RN2	D6 ~ D32	350 568
		3 Flutes, Corner Radius, Long Neck		SA300-RN3	D6 ~ D32	354 568
		4 Flutes, Corner Radius, Long Neck		SA300-SF-RN4	D10 ~ D20	361 569
		4 Flutes, Corner Radius, Long Neck (Internal Cooling with Coating)		SA300-SF-IC-RN4	D12 ~ D20	363 569
		6 Flutes, Corner Radius, Long Neck		SA300-WF-RN6	D16 ~ D25	365 569
		6 Flutes, Corner Radius, Long Neck (Internal Cooling with Coating)		SA300-WF-IC-RN6	D16 ~ D25	366 569
		1 Flute, Corner Radius		DNM100-RS1	D2 ~ D3	367 569

 Most Suitable  Suitable

Workpiece Material											
P		M	K	N			S		H		
1 2 3 4	5 6	1 2 3	1 2 3	1 2 3	4	5	1 2 3	4	1	2	3 4
Carbon Steel, Alloy	Alloy Steel	Stainless Steel	Cast Iron	Aluminium Alloys	Copper Alloys	Graphite, Composite Materials	Heat Resistant Super Alloys	Titanium Alloys	Hardened Steel	Hardened Steel	Hardened Steel
< 35HRC	≤ 48HRC								45-55HRC	55-60HRC	> 60HRC
⊙	⊙	⊙	⊙				⊙	⊙			
⊙	⊙	⊙	⊙				⊙	⊙			
⊙	⊙	⊙	⊙				⊙	⊙			
				⊙	⊙						
				⊙	⊙						
				⊙	⊙						
				⊙	⊙						
				⊙							
				⊙							
				⊙							
				⊙							
				⊙							
				⊙							
				⊙							
				⊙							
				⊙							
				⊙	⊙	⊙					





































Endmill Catalog (by Type)

No. of Flutes	Coating	Description	Type	Diameter Range	Dimension Page	Cutting Parameters Page
Corner Radius						
		2 Flutes, Corner Radius		DNM100-RS2	D4 ~ D10	368 569
		3 Flutes, Corner Radius		DNM100-RS3	D10 ~ D16	369 569
	U-DIA	4 Flutes, Corner Radius		SG200-R4	D2 ~ D12	374 570
	U-DIA	4 Flutes, Corner Radius, Long Neck		SG200-RN4	D2 ~ D12	375 570
	N-DIA	4 Flutes, Corner Radius, Long Neck		SG200-M-RN4	D1 ~ D10	379 571
	TiAlN	4 Flutes, Corner Radius		SN200-R4	D1 ~ D20	403 576
	TiAlN	4 Flutes, Corner Radius, Long Shank Length		SN200-RH4	D8 ~ D16	406 576
	AlCrN	4 Flutes, Corner Radius		ST210-R4	D2 ~ D20	383 572
	AlCrN	4 Flutes, Corner Radius, Long Neck		ST210-RN4	D6 ~ D20	385 572
	AlCrSiN	5 Flutes, Corner Radius, Long Flute Length		ST210-RL5	D16 ~ D25	388 573
	TiAlN	2 Flutes, Corner Radius		SH160-R2	D2 ~ D12	416 579
	TiAlN	4 Flutes, Corner Radius		SH160-R4	D1 ~ D12	418 579
	TiAlN	4 Flutes, Corner Radius, Long Shank Length		SH160-RH4	D4 ~ D12	421 579
	TiAlC/SiN	2 Flutes, Corner Radius		SH260-R2-H	D1 ~ D8	439 580
	TiAlC/SiN	2 Flutes, Corner Radius, Long Neck		SH260-RN2-H	D0.8 ~ D6	440 580
	TiAlC/SiN	4 Flutes, Corner Radius		SH260-R4-H	D1 ~ D12	442 581
	TiAlC/SiN	4 Flutes, Corner Radius, 45° Helix		SH260-R4A-H	D1 ~ D12	445 581

Most Suitable
 Suitable

Workpiece Material											
P		M	K	N			S		H		
1 2 3 4	5 6	1 2 3	1 2 3	1 2 3	4	5	1 2 3	4	1	2	3 4
Carbon Steel, Alloy	Alloy Steel	Stainless Steel	Cast Iron	Aluminium Alloys	Copper Alloys	Graphite, Composite Materials	Heat Resistant Super Alloys	Titanium Alloys	Hardened Steel	Hardened Steel	Hardened Steel
< 35HRC	≤ 48HRC								45-55HRC	55-60HRC	> 60HRC
				⊙	⊙	⊙					
				⊙	⊙	⊙					
				○	○	⊙					
				○	○	⊙					
						⊙					
	○	○	○				⊙				
	○	○	○				⊙				
	○	○	○					⊙			
	○	○	○					⊙			
	○	⊙							⊙	⊙	○
									⊙		
									⊙		
									⊙		
	○	⊙							⊙	⊙	○
	○	⊙							⊙	⊙	○
	○	⊙							⊙	⊙	○
	○	⊙							⊙	⊙	○

































Endmill Catalog (by Type)

No. of Flutes	Coating	Description	Type	Diameter Range	Dimension Page	Cutting Parameters Page
Corner Radius						
	TiAlC/SiN	4 Flutes, Corner Radius, Long Shank Length		SH260-RH4-H	D2 ~ D12	447 581
	TiAlC/SiN	4 Flutes, Corner Radius, Long Flute Length		SH260-RL4A-H	D6-D12	451 581
	TiAlC/SiN	4 Flutes, Corner Radius, 45° Helix, Long Shank Length		SH260-RH4A-H	D4 ~ D12	449 581
	TiAlC/SiN	4 Flutes, Corner Radius, Long Neck		SH260-RN4-H	D1 ~ D12	452 581
	TiAlSiN	4 Flutes, Corner Radius		SH360-R4	D1 ~ D12	464 584
	TiAlSiN	4 Flutes, Corner Radius, Long Shank Length		SH360-RH4	D4 ~ D12	466 584
	TiAlC/SiN	4 Flutes, Corner Radius		FH200-R4-H	D1 ~ D12	471 587
	TiAlC/SiN	4 Flutes, Corner Radius, Long Neck		FH200-RN4-H	D8 ~ D12	473 587
	TiAlC/SiN	6 Flutes, Corner Radius		FH200-R6-H	D6 ~ D20	474 587
	TiAlC/SiN	6 Flutes, Corner Radius, Long Shank Length		FH200-RH6-H	D6 ~ D20	475 587
	TiAlC/SiN	6 Flutes, Corner Radius, Long Neck		FH200-RN6-H	D6 ~ D20	476 587
Ballnose						
	AlCr/SiN	2 Flutes, Ballnose		UP210-B2	D0.8 ~ D20	259 547
	AlCr/SiN	2 Flutes, Ballnose, Long Shank Length		UP210-BH2	D2 ~ D20	261 547
	AlCr/SiN	4 Flutes, Ballnose		UP210-B4	D2 ~ D20	263 547
	AlCr/SiN	2 Flutes, Ballnose		SP210-B2	D1 ~ D12	276 550
	AlCr/SiN	2 Flutes, Ballnose, Long Shank Length		SP210-BH2	D4 ~ D12	277 550
	AlCr/SiN	2 Flutes, Ballnose, Long Neck, Micro Diameter		SPM200-BN2	D0.1 ~ D6	503 626
	TiAlSiN	2 Flutes, Ballnose, Long Neck, Micro Diameter		SHM200-BN2	D0.1 ~ D6	537 626

 Most Suitable  Suitable

Workpiece Material												
P		M	K	N			S		H			
1 2 3 4	5 6	1 2 3	1 2 3	1 2 3	4	5	1 2 3	4	1	2	3 4	
Carbon Steel, Alloy	Alloy Steel	Stainless Steel	Cast Iron	Aluminium Alloys	Copper Alloys	Graphite, Composite Materials	Heat Resistant Super Alloys	Titanium Alloys	Hardened Steel	Hardened Steel	Hardened Steel	
< 35HRC	≤ 48HRC								45-55HRC	55-60HRC	> 60HRC	
	○	◎							◎	◎	○	
	○	◎							◎	◎	○	
	○	◎							◎	◎	○	
	○	◎							◎	◎	○	
		○							○	◎	◎	
		○							○	◎	◎	
		◎							◎	◎	◎	
		◎							◎	◎	◎	
		◎							◎	◎	◎	
		◎							◎	◎	◎	
		◎							◎	◎	◎	
	◎	◎	○	◎								
	◎	◎	○	◎								
	◎	◎	○	◎								
	◎	◎	○	◎								
	◎	◎	○	◎								
	◎	◎	○	◎	○	◎		○	○	◎		
		○							○	◎	◎	

Endmill Catalog (by Type)

No. of Flutes	Coating	Description	Type	Diameter Range	Dimension Page	Cutting Parameters Page
Ballnose						
	TiAlN	2 Flutes, Ballnose		US200-B2	D1 ~ D20	296 560
	TiAlN	4 Flutes, Ballnose		US200-B4	D1 ~ D20	297 560
	TiAlN	4 Flutes, Ballnose		SS600-B4	D2 ~ D20	319 563
		2 Flutes, Ballnose		UA100-B2	D1 ~ D12	336 566
		2 Flutes, Ballnose, Long Neck		SA300-BN2	D6 ~ D20	358 568
	U-DIA	2 Flutes, Ballnose		SG200-B2	D0.5 ~ D12	376 571
	U-DIA	2 Flutes, Ballnose, Long Neck		SG200-BN2	D0.5 ~ D12	377 571
	N-DIA	2 Flutes, Ballnose		SG200-M-B2	D0.4 ~ D6	380 571
	N-DIA	2 Flutes, Ballnose, Long Neck		SG200-M-BN2	D0.5 ~ D6	381 571
	AlCrN	2 Flutes, Ballnose, Long Neck		SM200-TP2	R0.5 ~ R1.5	390 574
	N-DIA	2 Flutes/ 3 Flutes, Ballnose, Long Neck		SM200-RO2/RO3	R0.3 ~ R1.5	391 574
	N-DIA	2 Flutes/ 3 Flutes, Ballnose, Long Neck		SM200-VH2/VH3	R0.3 ~ R1	392 574
	N-DIA	2 Flutes/ 3 Flutes, Ballnose, Long Neck		SM200-WI2/WI3	R0.3 ~ R1.25	393 574
	N-DIA	2 Flutes/ 3 Flutes, Ballnose, Long Neck		SM200-IM2/IM3	R0.3 ~ R1.25	394 574
	N-DIA	2 Flutes/ 3 Flutes, Ballnose, Long Neck		SM200-ZI2/ZI3	R0.25 ~ R1.5	396 574
	AlCrN	2 Flutes/ 3 Flutes, Ballnose, Long Neck		SM200-ZI2/ZI3	R0.25 ~ R1.5	396 574

 Most Suitable  Suitable







Endmill Catalog (by Type)

No. of Flutes	Coating	Description	Type	Diameter Range	Dimension Page	Cutting Parameters Page
Ballnose						
2	N-DIA	2 Flutes/ 3 Flutes, Ballnose, Long Neck	SM200-AR2/AR3	R0.3 ~ R1.5	398	575
3	AlCrN					
2	N-DIA	2 Flutes, Ballnose, Long Neck	SM200-KL2	R0.3 ~ R1	400	574
2	AlCrN	2 Flutes, Ballnose, Long Neck	SM200-XT2	R0.3 ~ R1.5	401	575
2	N-DIA					
4	TiAlN	4 Flutes, Ballnose	SN200-B4	D2 ~ D12	407	577
4	TiAlN	4 Flutes, Ballnose, Long Shank Length	SN200-BH4	D8 ~ D12	408	577
4	AlCrSiN	4 Flutes, Conner radius, Unequally spaced cutting edges	ST210-B4	D2 ~ D20	389	573
2	TiAlN	2Flutes, Ballnose	SH160-B2	D0.5 ~ D20	422	579
2	TiAlN	2 Flutes, Ballnose, Long Shank Length	SH160-BH2	D4 ~ D12	424	579
4	TiAlN	4Flutes, Ballnose	SH160-B4	D2 ~ D16	425	579
2	TiAlC/SiN	2 Flutes, Ballnose	SH260-B2-H	D1 ~ D16	454	582
2	TiAlC/SiN	2 Flutes, Ballnose, Long Shank Length	SH260-BH2-H	D2 ~ D12	455	582
2	TiAlC/SiN	2 Flutes, Ballnose, Long Neck	SH260-BN2-H	D1 ~ D12	457	582
2	TiAlSiN	2 Flutes, Ballnose	SH360-B2	D0.6 ~ D20	467	585
2	TiAlSiN	2 Flutes, Ballnose, Long Shank Length	SH360-BH2	D4 ~ D20	468	585
4	TiAlSiN	4 Flutes, Ballnose	SH360-B4	D3 ~ D16	469	586
4	TiAlSiN	4 Flutes, Ballnose, Long Shank Length	SH360-BH4	D3 ~ D16	470	586

Most Suitable
 Suitable

Workpiece Material											
P		M	K	N			S	H			
1234	56	123	123	123	4	5	123	4	1	2	34
Carbon Steel, Alloy	Alloy Steel	Stainless Steel	Cast Iron	Aluminium Alloys	Copper Alloys	Graphite, Composite Materials	Heat Resistant Super Alloys	Titanium Alloys	Hardened Steel	Hardened Steel	Hardened Steel
< 35HRC	≤ 48HRC								45-55HRC	55-60HRC	> 60HRC
						⊙		⊙			
						⊙					
						⊙		⊙			
	○	○	⊙				⊙	○			
	○	○	⊙				⊙	○			
	○	○	⊙					⊙			
									⊙		
									⊙		
									⊙		
	○	⊙							⊙	⊙	○
	○	⊙							⊙	⊙	○
	○	⊙							⊙	⊙	○
		○							○	⊙	⊙
		○							○	⊙	⊙
		○							○	⊙	⊙
		○							○	⊙	⊙

Endmill Catalog (by Type)

No. of Flutes	Coating	Description	Type	Diameter Range	Dimension Page	Cutting Parameters Page
Other						
		4 Flutes, 60° Chamfer Endmills		UP210-L60	D4 ~ D20	264 548
		4 Flutes, 90° Chamfer Endmills		UP210-L90	D4 ~ D20	265 548
		4 Flutes, 120° Chamfer Endmills		UP210-L120	D4 ~ D20	266 548
		8/12Flutes, Rhombic Teeth		SD200-CN	D2 ~ D12	409 578

Most Suitable Suitable

Workpiece Material												
P		M	K	N			S		H			
1 2 3 4	5 6	1 2 3	1 2 3	1 2 3	4	5	1 2 3	4	1	2	3 4	
Carbon Steel, Alloy	Alloy Steel	Stainless Steel	Cast Iron	Aluminium Alloys	Copper Alloys	Graphite, Composite Materials	Heat Resistant Super Alloys	Titanium Alloys	Hardened Steel	Hardened Steel	Hardened Steel	
< 35HRC	≤ 48HRC								45-55HRC	55-60HRC	> 60HRC	
⊙	○	○	⊙	○	○							
⊙	○	○	⊙	○	○							
⊙	○	○	⊙	○	○							
						⊙						

UP210-SS2

2 Flutes, Stub Length, Square

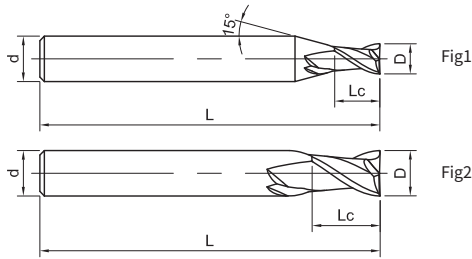

Please refer to page 167

Ordering Code	D	Lc	L	d	Figure No.	Stock
UP210-SS2-01002	1	2	50	4	1	●
UP210-SS2-01502	1.5	2	50	4	1	●
UP210-SS2-02003	2	3	50	4	1	●
UP210-SS2-02504	2.5	4	50	4	1	●
UP210-SS2-03005	3	5	50	4	1	●
UP210-SS2-04006	4	6	50	4	2	●
UP210-SS2-05008	5	8	50	6	1	●
UP210-SS2-06009	6	9	50	6	2	●
UP210-SS2-07010	7	10	60	8	1	●
UP210-SS2-08012	8	12	60	8	2	●
UP210-SS2-10015	10	15	75	10	2	●
UP210-SS2-12018	12	18	75	12	2	●
UP210-SS2-14021	14	21	100	14	2	○
UP210-SS2-16024	16	24	100	16	2	●
UP210-SS2-18027	18	27	100	18	2	○
UP210-SS2-20030	20	30	100	20	2	○

● Stock ○ Available upon Order

D	Tol
D ≤ 12	0 -0.02
D > 12	0 -0.03

Unit (mm)

Workpiece Material						
P		M	K	N		
1234	5	123	123	123	4	5
Carbon Steel, Alloy Steel (<35HRC)	Alloy Steel, Tool Steel (<48HRC)	Stainless Steel	Cast Iron	Aluminium Alloys	Copper Alloys	Graphite
○	○	○	○			

○ Most Suitable ○ Suitable

Recommended Cutting Data ※ P544

UP210-S2

2 Flutes, Standard Length, Square

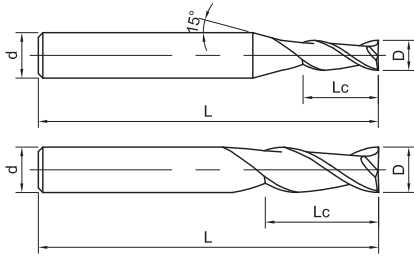
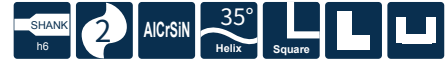

Fig1

Fig2



Please refer to page 167

Ordering Code	D	Lc	L	d	Figure No.	Stock
UP210-S2-01003	1	3	50	4	1	●
UP210-S2-01504	1.5	4	50	4	1	●
UP210-S2-02006	2	6	50	4	1	●
UP210-S2-02506	2.5	6	50	4	1	●
UP210-S2-02508	2.5	8	50	4	1	●
UP210-S2-03009	3	9	50	4	1	●
UP210-S2-63009	3	9	50	6	1	●
UP210-S2-03509	3.5	9	50	4	1	●
UP210-S2-63509	3.5	9	50	6	1	●
UP210-S2-04011	4	11	50	4	2	●
UP210-S2-64011	4	11	50	6	1	●
UP210-S2-04511	4.5	11	50	6	1	●
UP210-S2-04513	4.5	13	50	6	1	●
UP210-S2-05013	5	13	50	6	1	●
UP210-S2-05516	5.5	16	50	6	1	●
UP210-S2-06016	6	16	50	6	2	●
UP210-S2-06516	6.5	16	60	8	1	●
UP210-S2-07020	7	20	60	8	1	●

● Stock ○ Available upon Order

D	Tol
D ≤ 12	0 -0.02
D > 12	0 -0.03

Unit (mm)

Workpiece Material						
P		M	K	N		
1234	5	123	123	123	4	5
Carbon Steel, Alloy Steel (<35HRC)	Alloy Steel, Tool Steel (<48HRC)	Stainless Steel	Cast Iron	Aluminium Alloys	Copper Alloys	Graphite
○	○	○	○			

○ Most Suitable ○ Suitable

Recommended Cutting Data ※ P544

UP210-S2

2 Flutes, Standard Length, Square

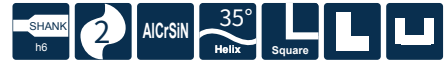
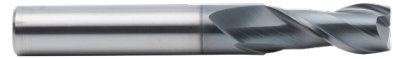
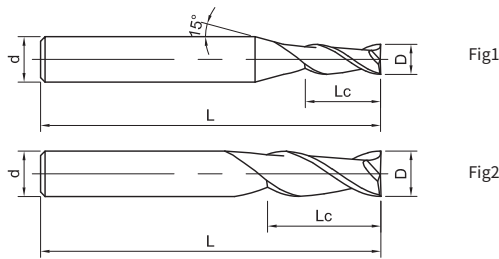

Please refer to page 167

» Continuation

Ordering Code	D	Lc	L	d	Figure No.	Stock
UP210-S2-07520	7.5	20	60	8	1	●
UP210-S2-08020	8	20	60	8	2	●
UP210-S2-08523	8.5	23	75	10	1	○
UP210-S2-09023	9	23	75	10	1	●
UP210-S2-09525	9.5	25	75	10	1	●
UP210-S2-10025	10	25	75	10	2	●
UP210-S2-10526	10.5	26	75	12	1	●
UP210-S2-11028	11	28	75	12	1	●
UP210-S2-12030	12	30	75	12	2	●
UP210-S2-13032	13	32	100	14	1	●
UP210-S2-14034	14	34	100	14	2	●
UP210-S2-15036	15	36	100	16	1	●
UP210-S2-16036	16	36	100	16	2	●
UP210-S2-17040	17	40	100	20	1	●
UP210-S2-18040	18	40	100	18	2	●
UP210-S2-19040	19	40	100	20	1	○
UP210-S2-20045	20	45	100	20	2	●

● Stock ○ Available upon Order

D	Tol
D ≤ 12	0 -0.02
D > 12	0 -0.03

Unit (mm)

Workpiece Material						
P		M	K	N		
1234	5	123	123	123	4	5
Carbon Steel, Alloy Steel (<35HRC)	Alloy Steel, Tool Steel (<48HRC)	Stainless Steel	Cast Iron	Aluminium Alloys	Copper Alloys	Graphite
○	○	○	○			

○ Most Suitable ○ Suitable

Recommended Cutting Data ※ P544

UP210-SL2

2 Flutes, Long Flute Length, Square

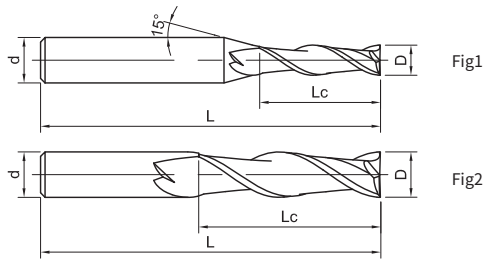

Please refer to page 167

Ordering Code	D	Lc	L	d	Figure No.	Stock
UP210-SL2-02015	2	15	75	4	1	●
UP210-SL2-03025	3	25	75	4	1	●
UP210-SL2-04030	4	30	75	4	2	●
UP210-SL2-05030	5	30	75	6	1	●
UP210-SL2-06035	6	35	75	6	2	●
UP210-SL2-08040	8	40	100	8	2	●
UP210-SL2-10045	10	45	100	10	2	●
UP210-SL2-12050	12	50	100	12	2	●
UP210-SL2-14055	14	55	100	14	2	●
UP210-SL2-16050	16	50	150	16	2	●
UP210-SL2-16060	16	60	150	16	2	●
UP210-SL2-18065	18	65	150	18	2	○
UP210-SL2-20070	20	70	150	20	2	●

● Stock ○ Available upon Order

D	Tol
D ≤ 12	0 -0.02
D > 12	0 -0.03

Unit (mm)

Workpiece Material						
P		M	K	N		
1234	5	123	123	123	4	5
Carbon Steel, Alloy Steel (<35HRC)	Alloy Steel, Tool Steel (<48HRC)	Stainless Steel	Cast Iron	Aluminium Alloys	Copper Alloys	Graphite
○	○	○	○			

○ Most Suitable ○ Suitable

Recommended Cutting Data ※ P544

UP210-SH2

2 Flutes, Long Shank Length, Square

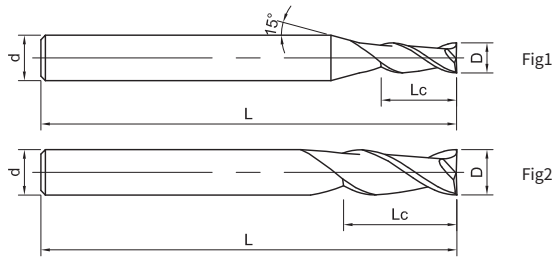

Please refer to page 167

Ordering Code	D	Lc	L	d	Figure No.	Stock
UP210-SH2-02006	2	6	75	4	1	●
UP210-SH2-03009	3	9	75	4	1	●
UP210-SH2-63012	3	12	75	6	1	●
UP210-SH2-04011	4	11	75	4	2	●
UP210-SH2-64011	4	11	75	6	1	○
UP210-SH2-05020	5	20	75	6	1	●
UP210-SH2-06016	6	16	100	6	2	●
UP210-SH2-06020	6	20	100	6	2	●
UP210-SH2-08020	8	20	100	8	2	●
UP210-SH2-08025	8	25	100	8	2	●
UP210-SH2-10030	10	30	100	10	2	●
UP210-SH2-12035	12	35	100	12	2	●
UP210-SH2-14036	14	36	150	14	2	○
UP210-SH2-15035	15	35	150	16	1	○
UP210-SH2-16036	16	36	150	16	2	●
UP210-SH2-18045	18	45	150	18	2	○
UP210-SH2-20045	20	45	150	20	2	●

● Stock ○ Available upon Order

D	Tol
D ≤ 12	0 -0.02
D > 12	0 -0.03

Unit (mm)

Workpiece Material						
P		M	K	N		
1234	5	123	123	123	4	5
Carbon Steel, Alloy Steel (<35HRC)	Alloy Steel, Tool Steel (<48HRC)	Stainless Steel	Cast Iron	Aluminium Alloys	Copper Alloys	Graphite
○	○	○	○			

○ Most Suitable ○ Suitable

Recommended Cutting Data ※ P544

UP210-S3

3 Flutes, Square

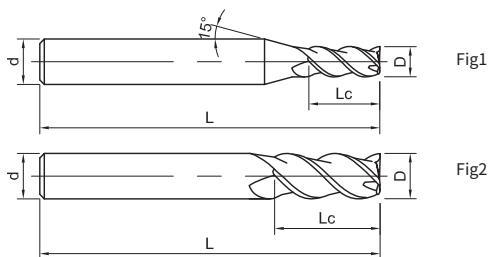

Please refer to page 167

Ordering Code	D	Lc	L	d	Figure No.	Stock
UP210-S3-02006	2	6	50	4	1	●
UP210-S3-03009	3	9	50	4	1	●
UP210-S3-04011	4	11	50	4	2	●
UP210-S3-05013	5	13	50	6	1	●
UP210-S3-06016	6	16	50	6	2	●
UP210-S3-06516	6.5	16	60	8	1	●
UP210-S3-08020	8	20	60	8	2	●
UP210-S3-09524	9.5	24	75	10	1	○
UP210-S3-10025	10	25	75	10	2	●
UP210-S3-12030	12	30	75	12	2	●
UP210-S3-14032	14	32	100	14	2	●
UP210-S3-16036	16	36	100	16	2	●
UP210-S3-18040	18	40	100	18	2	●
UP210-S3-20045	20	45	100	20	2	●
UP210-S3-25050	25	50	100	25	2	●

● Stock ○ Available upon Order

D	Tol
D ≤ 12	0 -0.02
D > 12	0 -0.03

Unit (mm)

Workpiece Material						
P		M	K	N		
1234	5	123	123	123	4	5
Carbon Steel, Alloy Steel (<35HRC)	Alloy Steel, Tool Steel (<48HRC)	Stainless Steel	Cast Iron	Aluminium Alloys	Copper Alloys	Graphite
○	○	○	○			

○ Most Suitable ○ Suitable

Recommended Cutting Data ※ P544

UP210-SS4

4 Flutes, Stub Length, Square

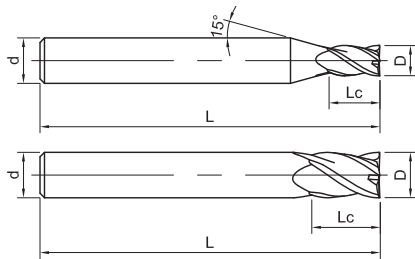

Fig1

Fig2



Please refer to page 167

Ordering Code	D	Lc	L	d	Figure No.	Stock
UP210-SS4-01002	1	2	50	4	1	●
UP210-SS4-01502	1.5	2	50	4	1	●
UP210-SS4-02003	2	3	50	4	1	●
UP210-SS4-02504	2.5	4	50	4	1	●
UP210-SS4-03005	3	5	50	4	1	●
UP210-SS4-04006	4	6	50	4	2	●
UP210-SS4-05008	5	8	50	6	1	○
UP210-SS4-06009	6	9	50	6	2	●
UP210-SS4-07010	7	10	60	8	1	●
UP210-SS4-08012	8	12	60	8	2	●
UP210-SS4-10015	10	15	75	10	2	●
UP210-SS4-12018	12	18	75	12	2	●
UP210-SS4-14021	14	21	100	14	2	○
UP210-SS4-16024	16	24	100	16	2	●
UP210-SS4-18027	18	27	100	18	2	○
UP210-SS4-20030	20	30	100	20	2	●

● Stock ○ Available upon Order

D	Tol
D ≤ 12	0 -0.02
D > 12	0 -0.03

Unit (mm)

Workpiece Material						
P		M	K	N		
1234	5	123	123	123	4	5
Carbon Steel, Alloy Steel (<35HRC)	Alloy Steel, Tool Steel (<48HRC)	Stainless Steel	Cast Iron	Aluminium Alloys	Copper Alloys	Graphite
○	○	○	○			

○ Most Suitable ○ Suitable

Recommended Cutting Data ※ P545

UP210-S4

4 Flutes, Standard Length, Square

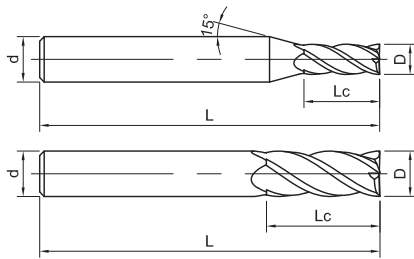

Fig1

Fig2



Please refer to page 167

Ordering Code	D	Lc	L	d	Figure No.	Stock
UP210-S4-01003	1	3	50	4	1	●
UP210-S4-61003	1	3	50	6	1	●
UP210-S4-01505	1.5	5	50	4	1	●
UP210-S4-61505	1.5	5	50	6	1	●
UP210-S4-02006	2	6	50	4	1	●
UP210-S4-62006	2	6	50	6	1	●
UP210-S4-02508	2.5	8	50	4	1	●
UP210-S4-62508	2.5	8	50	6	1	●
UP210-S4-03009	3	9	50	4	1	●
UP210-S4-63006	3	6	50	6	1	●
UP210-S4-63009	3	9	50	6	1	●
UP210-S4-03511	3.5	11	50	4	1	●
UP210-S4-63509	3.5	9	50	6	1	●
UP210-S4-04011	4	11	50	4	2	●
UP210-S4-64011	4	11	50	6	1	●
UP210-S4-04511	4.5	11	50	6	1	●
UP210-S4-05013	5	13	50	6	1	●
UP210-S4-05516	5.5	16	50	6	1	●
UP210-S4-06016	6	16	50	6	2	●
UP210-S4-06516	6.5	16	60	8	1	●

● Stock ○ Available upon Order

D	Tol
D ≤ 12	0 -0.02
D > 12	0 -0.03

Unit (mm)

Workpiece Material						
P		M	K	N		
1234	5	123	123	123	4	5
Carbon Steel, Alloy Steel (<35HRC)	Alloy Steel, Tool Steel (<48HRC)	Stainless Steel	Cast Iron	Aluminium Alloys	Copper Alloys	Graphite
○	○	○	○			

○ Most Suitable ○ Suitable

Recommended Cutting Data ※ P545

UP210-S4

4 Flutes, Standard Length, Square

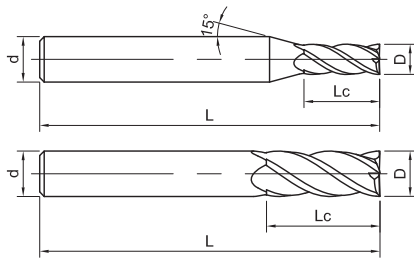

Fig1

Fig2



Please refer to page 167

» Continuation

Ordering Code	D	Lc	L	d	Figure No.	Stock
UP210-S4-07020	7	20	60	8	1	●
UP210-S4-07520	7.5	20	60	8	1	●
UP210-S4-08020	8	20	60	8	2	●
UP210-S4-08523	8.5	23	75	10	1	●
UP210-S4-09023	9	23	75	10	1	●
UP210-S4-09525	9.5	25	75	10	1	●
UP210-S4-10025	10	25	75	10	2	●
UP210-S4-11028	11	28	75	12	1	●
UP210-S4-12030	12	30	75	12	2	●
UP210-S4-13032	13	32	100	14	1	●
UP210-S4-14032	14	32	75	14	2	●
UP210-S4-14034	14	34	100	14	2	●
UP210-S4-15036	15	36	100	16	1	●
UP210-S4-16036	16	36	100	16	2	●
UP210-S4-16040	16	40	100	16	2	●
UP210-S4-16045	16	45	100	16	2	●
UP210-S4-17038	17	38	100	18	1	●
UP210-S4-18045	18	45	100	18	2	●
UP210-S4-20045	20	45	100	20	2	●
UP210-S4-22045	22	45	100	25	1	○

● Stock ○ Available upon Order

D	Tol
D ≤ 12	0 -0.02
D > 12	0 -0.03

Unit (mm)

Workpiece Material						
P		M	K	N		
1234	5	123	123	123	4	5
Carbon Steel, Alloy Steel (<35HRC)	Alloy Steel, Tool Steel (<48HRC)	Stainless Steel	Cast Iron	Aluminium Alloys	Copper Alloys	Graphite
○	○	○	○			

○ Most Suitable ○ Suitable

Recommended Cutting Data ※ P545

UP210-SL4

4 Flutes, Long Flute Length, Square

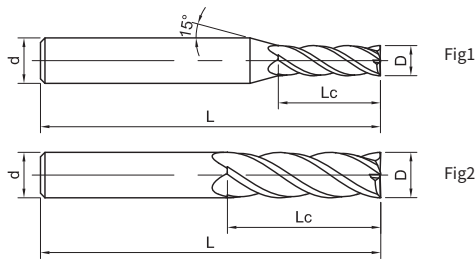

Please refer to page 167

Ordering Code	D	Lc	L	d	Figure No.	Stock
UP210-SL4-01004	1	4	50	4	1	●
UP210-SL4-02010	2	10	50	4	1	●
UP210-SL4-03015	3	15	60	4	1	●
UP210-SL4-63015	3	15	60	6	1	●
UP210-SL4-04020	4	20	60	4	2	●
UP210-SL4-64020	4	20	75	6	1	●
UP210-SL4-04030	4	30	75	4	2	●
UP210-SL4-05025	5	25	75	6	1	●
UP210-SL4-05030	5	30	75	6	1	●
UP210-SL4-06020	6	20	50	6	2	●
UP210-SL4-06030	6	30	75	6	2	●
UP210-SL4-06035	6	35	75	6	2	●
UP210-SL4-06035A	6	35	100	6	2	●
UP210-SL4-08025	8	25	75	8	2	●
UP210-SL4-08035	8	35	100	8	2	●

● Stock ○ Available upon Order

D	Tol
D ≤ 12	0 -0.02
D > 12	0 -0.03

Unit (mm)

Workpiece Material						
P		M	K	N		
1234	5	123	123	123	4	5
Carbon Steel, Alloy Steel (<35HRC)	Alloy Steel, Tool Steel (<48HRC)	Stainless Steel	Cast Iron	Aluminium Alloys	Copper Alloys	Graphite
○	○	○	○			

○ Most Suitable ○ Suitable

Recommended Cutting Data ※ P545

UP210-SL4

4 Flutes, Long Flute Length, Square

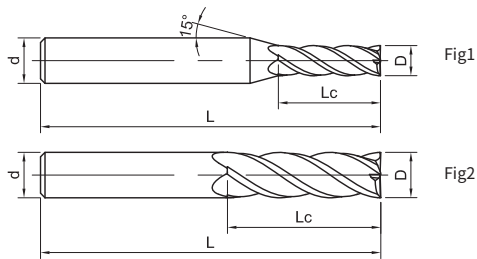

Please refer to page 167

» Continuation

Ordering Code	D	Lc	L	d	Figure No.	Stock
UP210-SL4-08040	8	40	100	8	2	●
UP210-SL4-10035	10	35	75	10	2	●
UP210-SL4-10045	10	45	100	10	2	●
UP210-SL4-10050	10	50	100	10	2	●
UP210-SL4-12045	12	45	100	12	2	●
UP210-SL4-12050	12	50	100	12	2	●
UP210-SL4-14045	14	45	100	14	2	●
UP210-SL4-16050	16	50	150	16	2	●
UP210-SL4-16060	16	60	150	16	2	●
UP210-SL4-16065	16	65	120	16	2	●
UP210-SL4-16070	16	70	150	16	2	●
UP210-SL4-18070	18	70	150	18	2	●
UP210-SL4-20070	20	70	150	20	2	●
UP210-SL4-20080	20	80	150	20	2	●

● Stock ○ Available upon Order

D	Tol
D ≤ 12	0 -0.02
D > 12	0 -0.03

Unit (mm)

Workpiece Material						
P		M	K	N		
1234	5	123	123	123	4	5
Carbon Steel, Alloy Steel (<35HRC)	Alloy Steel, Tool Steel (<48HRC)	Stainless Steel	Cast Iron	Aluminium Alloys	Copper Alloys	Graphite
○	○	○	○			

○ Most Suitable ○ Suitable

Recommended Cutting Data ※ P545

UP210-SH4

4 Flutes, Long Shank Length, Square

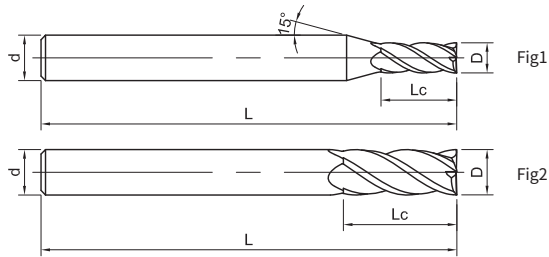

Please refer to page 167

Ordering Code	D	Lc	L	d	Figure No.	Stock
UP210-SH4-02010	2	10	75	4	1	●
UP210-SH4-03012	3	12	75	4	1	●
UP210-SH4-03012A	3	12	100	4	1	●
UP210-SH4-04011	4	11	75	4	2	●
UP210-SH4-04011A	4	11	100	4	2	●
UP210-SH4-04015	4	15	75	4	2	●
UP210-SH4-05020	5	20	75	6	1	●
UP210-SH4-06016	6	16	75	6	2	●
UP210-SH4-06020	6	20	75	6	2	●
UP210-SH4-06020A	6	20	100	6	2	●
UP210-SH4-08020	8	20	100	8	2	●
UP210-SH4-08025	8	25	100	8	2	●
UP210-SH4-08025A	8	25	75	8	2	●
UP210-SH4-10030	10	30	100	10	2	●
UP210-SH4-10035	10	35	100	10	2	●
UP210-SH4-12035	12	35	100	12	2	●
UP210-SH4-14036	14	36	150	14	2	●
UP210-SH4-16036	16	36	150	16	2	●
UP210-SH4-18045	18	45	150	18	2	●
UP210-SH4-20045	20	45	150	20	2	●

● Stock ○ Available upon Order

D	Tol
D ≤ 12	0 -0.02
D > 12	0 -0.03

Unit (mm)

Workpiece Material						
P		M	K	N		
1234	5	123	123	123	4	5
Carbon Steel, Alloy Steel (<35HRC)	Alloy Steel, Tool Steel (<48HRC)	Stainless Steel	Cast Iron	Aluminium Alloys	Copper Alloys	Graphite
○	○	○	○			

○ Most Suitable ○ Suitable

Recommended Cutting Data ※ P545

UP210-SC4

4 Flutes, Acute Angle, Square

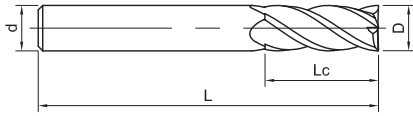

Fig1



Please refer to page 167

Ordering Code	D	Lc	L	d	Figure No.	Stock
UP210-SC4-04011	4	11	50	4	1	●
UP210-SC4-06016	6	16	50	6	1	●
UP210-SC4-08020	8	20	60	8	1	○
UP210-SC4-10025	10	25	75	10	1	●
UP210-SC4-12030	12	30	75	12	1	○
UP210-SC4-16036	16	36	100	16	1	●
UP210-SC4-20045	20	45	100	20	1	○

● Stock ○ Available upon Order

D	Tol
D ≤ 12	0 -0.02
D > 12	0 -0.03

Unit (mm)

Workpiece Material						
P		M	K	N		
1234	5	123	123	123	4	5
Carbon Steel, Alloy Steel (<35HRC)	Alloy Steel, Tool Steel (<48HRC)	Stainless Steel	Cast Iron	Aluminium Alloys	Copper Alloys	Graphite
○	○	○	○			

○ Most Suitable ○ Suitable

Recommended Cutting Data ※ P545

UP210-S4A

4 Flutes, 45° Helix, Square

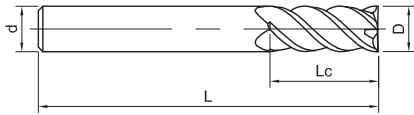

Fig1



Please refer to page 167

Ordering Code	D	Lc	L	d	Figure No.	Stock
UP210-S4A-04011	4	11	50	4	1	●
UP210-S4A-06016	6	16	50	6	1	●
UP210-S4A-08020	8	20	60	8	1	●
UP210-S4A-10025	10	25	75	10	1	●
UP210-S4A-12030	12	30	75	12	1	●
UP210-S4A-16036	16	36	100	16	1	●
UP210-S4A-20045	20	45	100	20	1	○

● Stock ○ Available upon Order

D	Tol
D ≤ 12	0 -0.02
D > 12	0 -0.03

Unit (mm)

Workpiece Material						
P		M	K	N		
1234	5	123	123	123	4	5
Carbon Steel, Alloy Steel (<35HRC)	Alloy Steel, Tool Steel (<48HRC)	Stainless Steel	Cast Iron	Aluminium Alloys	Copper Alloys	Graphite
○	○	○	○			

○ Most Suitable ○ Suitable

Recommended Cutting Data ※ P545

UP210-S6

6 Flutes, Standard Length, Square

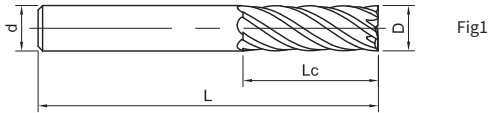

Please refer to page 167

Ordering Code	D	Lc	L	d	Figure No.	Stock
UP210-S6-06015	6	15	50	6	1	●
UP210-S6-08020	8	20	60	8	1	●
UP210-S6-10025	10	25	75	10	1	●
UP210-S6-12030	12	30	75	12	1	●
UP210-S6-14032	14	32	100	14	1	○
UP210-S6-16036	16	36	100	16	1	●
UP210-S6-18040	18	40	100	18	1	○
UP210-S6-20045	20	45	100	20	1	●

● Stock ○ Available upon Order

D	Tol
D ≤ 12	0 -0.02
D > 12	0 -0.03

Unit (mm)

Workpiece Material						
P		M	K	N		
1234	5	123	123	123	4	5
Carbon Steel, Alloy Steel (<35HRC)	Alloy Steel, Tool Steel (<48HRC)	Stainless Steel	Cast Iron	Aluminium Alloys	Copper Alloys	Graphite
○	○	○	○			

○ Most Suitable ○ Suitable

Recommended Cutting Data ※ P545

UP210-R2

2 Flutes, Corner Radius

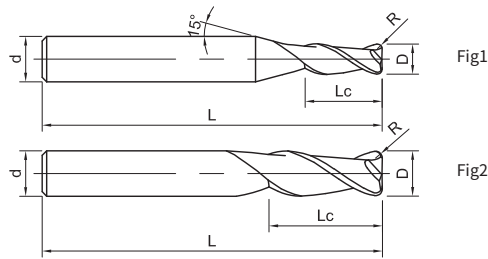

Please refer to page 167

Ordering Code	D	Lc	R	L	d	Figure No.	Stock
UP210-R2-01002	1	3	0.2	50	4	1	●
UP210-R2-01502	1.5	5	0.2	50	4	1	●
UP210-R2-02002	2	6	0.2	50	4	1	●
UP210-R2-03002	3	9	0.2	50	4	1	●
UP210-R2-63002	3	9	0.2	50	6	1	●
UP210-R2-03003	3	9	0.3	50	4	1	●
UP210-R2-63003	3	9	0.3	50	6	1	●
UP210-R2-03005	3	9	0.5	50	4	1	●
UP210-R2-63005	3	9	0.5	50	6	1	●
UP210-R2-04002	4	11	0.2	50	4	2	●
UP210-R2-64002	4	11	0.2	50	6	1	●
UP210-R2-04003	4	11	0.3	50	4	2	●
UP210-R2-64003	4	11	0.3	50	6	1	●
UP210-R2-04005	4	11	0.5	50	4	2	●
UP210-R2-64005	4	11	0.5	50	6	1	●
UP210-R2-04010	4	11	1	50	4	2	●
UP210-R2-05002	5	13	0.2	50	6	1	○
UP210-R2-05003	5	13	0.3	50	6	1	●

● Stock ○ Available upon Order

D	Tol
D ≤ 12	0 -0.02
D > 12	0 -0.03

Unit (mm)

Workpiece Material						
P		M	K	N		
1234	5	123	123	123	4	5
Carbon Steel, Alloy Steel (<35HRC)	Alloy Steel, Tool Steel (<48HRC)	Stainless Steel	Cast Iron	Aluminium Alloys	Copper Alloys	Graphite
◎	◎	○	◎			

◎ Most Suitable ○ Suitable

Recommended Cutting Data ※ P544

UP210-R2

2 Flutes, Corner Radius

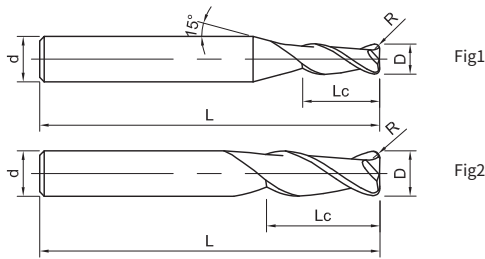

Please refer to page 167

» Continuation

Ordering Code	D	Lc	R	L	d	Figure No.	Stock
UP210-R2-05005	5	13	0.5	50	6	1	●
UP210-R2-05010	5	13	1	50	6	1	●
UP210-R2-06005	6	16	0.5	50	6	2	●
UP210-R2-06010	6	16	1	50	6	2	●
UP210-R2-06015	6	16	1.5	50	6	2	○
UP210-R2-06020	6	16	2	50	6	2	○
UP210-R2-08003	8	20	0.3	60	8	2	●
UP210-R2-08005	8	20	0.5	60	8	2	●
UP210-R2-08005A	8	20	0.5	75	8	2	●
UP210-R2-08010	8	20	1	60	8	2	●
UP210-R2-08015	8	20	1.5	60	8	2	●
UP210-R2-08020	8	20	2	60	8	2	●
UP210-R2-10003	10	25	0.3	75	10	2	●
UP210-R2-10005	10	25	0.5	75	10	2	●
UP210-R2-10010	10	25	1	75	10	2	●
UP210-R2-10015	10	25	1.5	75	10	2	●
UP210-R2-10020	10	25	2	75	10	2	●

● Stock ○ Available upon Order

D	Tol
D ≤ 12	0 -0.02
D > 12	0 -0.03

Unit (mm)

Workpiece Material						
P		M	K	N		
1234	5	123	123	123	4	5
Carbon Steel, Alloy Steel (<35HRC)	Alloy Steel, Tool Steel (<48HRC)	Stainless Steel	Cast Iron	Aluminium Alloys	Copper Alloys	Graphite
○	○	○	○			

○ Most Suitable ○ Suitable

Recommended Cutting Data ※ P544

UP210-R2

2 Flutes, Corner Radius

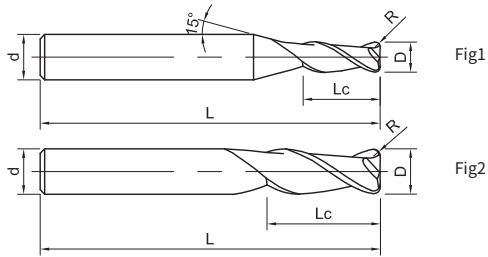

Please refer to page 167

» Continuation

Ordering Code	D	Lc	R	L	d	Figure No.	Stock
UP210-R2-10030	10	30	3	75	10	2	●
UP210-R2-12005	12	30	0.5	75	12	2	●
UP210-R2-12010	12	30	1	75	12	2	●
UP210-R2-12015	12	30	1.5	75	12	2	●
UP210-R2-12020	12	30	2	75	12	2	●
UP210-R2-12030	12	30	3	75	12	2	●
UP210-R2-14010	14	32	1	100	14	2	●
UP210-R2-14020	14	32	2	100	14	2	●
UP210-R2-16005	16	36	0.5	100	16	2	○
UP210-R2-16010	16	36	1	100	16	2	●
UP210-R2-16020	16	36	2	100	16	2	○
UP210-R2-16030	16	36	3	100	16	2	●
UP210-R2-18010	18	40	1	100	18	2	●
UP210-R2-18020	18	40	2	100	18	2	●
UP210-R2-20010	20	45	1	100	20	2	●
UP210-R2-20020	20	45	2	100	20	2	●

● Stock ○ Available upon Order

D	Tol
D ≤ 12	0 -0.02
D > 12	0 -0.03

Unit (mm)

Workpiece Material

P		M	K	N		
1234	5	123	123	123	4	5
Carbon Steel, Alloy Steel (<35HRC)	Alloy Steel, Tool Steel (<48HRC)	Stainless Steel	Cast Iron	Aluminium Alloys	Copper Alloys	Graphite
○	○	○	○			

○ Most Suitable ○ Suitable

Recommended Cutting Data ※ P544

UP210-RH2

2 Flutes, Corner Radius, with Long Shank Length

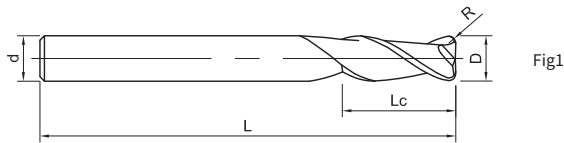

Please refer to page 167

Ordering Code	D	Lc	R	L	d	Figure No.	Stock
UP210-RH2-04005	4	11	0.5	75	4	1	●
UP210-RH2-06005	6	16	0.5	75	6	2	●
UP210-RH2-06010	6	16	1	75	6	2	●
UP210-RH2-06015	6	16	1.5	75	6	2	○
UP210-RH2-08005	8	20	0.5	100	8	2	●
UP210-RH2-08010	8	20	1	100	8	2	●
UP210-RH2-08015	8	20	1.5	100	8	2	○
UP210-RH2-10005	10	25	0.5	100	10	2	●
UP210-RH2-10010	10	25	1	100	10	2	●
UP210-RH2-10015	10	25	1.5	100	10	2	○
UP210-RH2-10020	10	25	2	100	10	2	○
UP210-RH2-12005	12	30	0.5	100	12	2	●
UP210-RH2-12010	12	30	1	100	12	2	●

● Stock ○ Available upon Order

D	Tol
D ≤ 12	0 -0.02
D > 12	0 -0.03

Unit (mm)

Workpiece Material						
P		M	K	N		
1234	5	123	123	123	4	5
Carbon Steel, Alloy Steel (<35HRC)	Alloy Steel, Tool Steel (<48HRC)	Stainless Steel	Cast Iron	Aluminium Alloys	Copper Alloys	Graphite
○	○	○	○			

○ Most Suitable ○ Suitable

Recommended Cutting Data ※ P544

UP210-RH2

2 Flutes, Corner Radius, with Long Shank Length

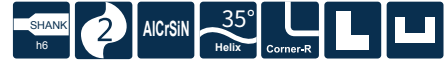
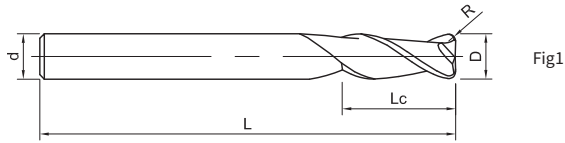

Please refer to page 167

» Continuation

Ordering Code	D	Lc	R	L	d	Figure No.	Stock
UP210-RH2-12015	12	30	1.5	100	12	2	○
UP210-RH2-12020	12	30	2	100	12	2	○
UP210-RH2-14010	14	36	1	150	14	2	○
UP210-RH2-14020	14	36	2	150	14	2	○
UP210-RH2-16005	16	36	0.5	150	16	2	○
UP210-RH2-16010	16	36	1	150	16	2	●
UP210-RH2-16015	16	36	1.5	150	16	2	○
UP210-RH2-16020	16	36	2	150	16	2	○
UP210-RH2-18010	18	45	1	150	18	2	●
UP210-RH2-18020	18	45	2	150	18	2	○
UP210-RH2-20010	20	45	1	150	20	2	●
UP210-RH2-20020	20	45	2	150	20	2	○

● Stock ○ Available upon Order

D	Tol
D ≤ 12	0 -0.02
D > 12	0 -0.03

Unit (mm)

Workpiece Material						
P		M	K	N		
1234	5	123	123	123	4	5
Carbon Steel, Alloy Steel (<35HRC)	Alloy Steel, Tool Steel (<48HRC)	Stainless Steel	Cast Iron	Aluminium Alloys	Copper Alloys	Graphite
○	○	○	○			

○ Most Suitable ○ Suitable

Recommended Cutting Data ※ P544

UP210-R4

4 Flutes, Corner Radius

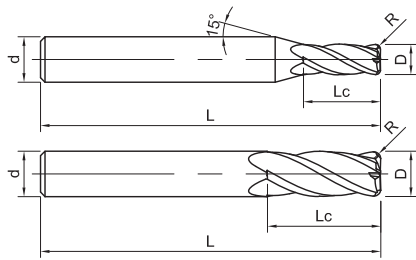

Fig1

Fig2



Please refer to page 167

Ordering Code	D	Lc	R	L	d	Figure No.	Stock
UP210-R4-01002	1	3	0.2	50	4	1	●
UP210-R4-01502	1.5	5	0.2	50	4	1	●
UP210-R4-02002	2	6	0.2	50	4	1	●
UP210-R4-03002	3	9	0.2	50	4	1	●
UP210-R4-03003	3	9	0.3	50	4	1	●
UP210-R4-03005	3	9	0.5	50	4	1	●
UP210-R4-04002	4	11	0.2	50	4	2	●
UP210-R4-04003	4	11	0.3	50	4	2	●
UP210-R4-04005	4	11	0.5	50	4	2	●
UP210-R4-04010	4	11	1	50	4	2	●
UP210-R4-04510	4.5	12	1	50	6	1	○
UP210-R4-05002	5	13	0.2	50	6	1	●
UP210-R4-05005	5	13	0.5	50	6	1	●
UP210-R4-05010	5	13	1	50	6	1	●
UP210-R4-05015	5	13	1.5	50	6	1	●
UP210-R4-06002	6	16	0.2	50	6	2	●
UP210-R4-06005	6	16	0.5	50	6	2	●
UP210-R4-06005A	6	16	0.5	60	6	2	○
UP210-R4-06010	6	16	1	50	6	2	●

● Stock ○ Available upon Order

D	Tol
D ≤ 12	0 -0.02
D > 12	0 -0.03

Unit (mm)

Workpiece Material						
P		M	K	N		
1234	5	123	123	123	4	5
Carbon Steel, Alloy Steel (<35HRC)	Alloy Steel, Tool Steel (<48HRC)	Stainless Steel	Cast Iron	Aluminium Alloys	Copper Alloys	Graphite
○	○	○	○			

○ Most Suitable ○ Suitable

Recommended Cutting Data ※ P545

UP210-R4

4 Flutes, Corner Radius

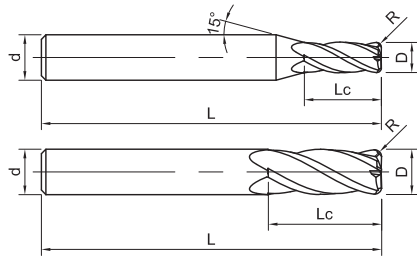

Fig1

Fig2



Please refer to page 167

» Continuation

Ordering Code	D	Lc	R	L	d	Figure No.	Stock
UP210-R4-06015	6	16	1.5	50	6	2	●
UP210-R4-08003	8	20	0.3	60	8	2	●
UP210-R4-08005	8	20	0.5	60	8	2	●
UP210-R4-08005A	8	20	0.5	75	8	2	●
UP210-R4-08010	8	20	1	60	8	2	●
UP210-R4-08010A	8	20	1	75	8	2	●
UP210-R4-08015	8	20	1.5	60	8	2	●
UP210-R4-08020	8	20	2	60	8	2	●
UP210-R4-10002	10	25	0.2	75	10	2	●
UP210-R4-10003	10	25	0.3	75	10	2	●
UP210-R4-10005	10	25	0.5	75	10	2	●
UP210-R4-10010	10	25	1	75	10	2	●
UP210-R4-10015	10	25	1.5	75	10	2	●
UP210-R4-10020	10	25	2	75	10	2	●
UP210-R4-10025	10	25	2.5	75	10	2	●
UP210-R4-10030	10	25	3	75	10	2	●
UP210-R4-12005	12	30	0.5	75	12	2	●
UP210-R4-12010	12	30	1	75	12	2	●

● Stock ○ Available upon Order

D	Tol
D ≤ 12	0 -0.02
D > 12	0 -0.03

Unit (mm)

Workpiece Material

P		M	K	N		
1234	5	123	123	123	4	5
Carbon Steel, Alloy Steel (<35HRC)	Alloy Steel, Tool Steel (<48HRC)	Stainless Steel	Cast Iron	Aluminium Alloys	Copper Alloys	Graphite
○	○	○	○			

○ Most Suitable ○ Suitable

Recommended Cutting Data ※ P545

UP210-R4

4 Flutes, Corner Radius

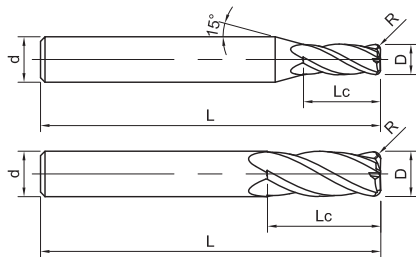

Fig1

Fig2



Please refer to page 167

» Continuation

Ordering Code	D	Lc	R	L	d	Figure No.	Stock
UP210-R4-12015	12	30	1.5	75	12	2	●
UP210-R4-12020	12	30	2	75	12	2	●
UP210-R4-12025	12	30	2.5	75	12	2	●
UP210-R4-12030	12	30	3	75	12	2	●
UP210-R4-14010	14	32	1	100	14	2	●
UP210-R4-14020	14	32	2	100	14	2	●
UP210-R4-16005	16	36	0.5	100	16	2	●
UP210-R4-16010	16	36	1	100	16	2	●
UP210-R4-16020	16	36	2	100	16	2	●
UP210-R4-16030	16	36	3	100	16	2	●
UP210-R4-18010	18	40	1	100	18	2	○
UP210-R4-18020	18	40	2	100	18	2	●
UP210-R4-20010	20	45	1	100	20	2	●
UP210-R4-20020	20	45	2	100	20	2	●
UP210-R4-20030	20	45	3	100	20	2	●
UP210-R4-20040	20	45	4	100	20	2	●
UP210-R4-20050	20	45	5	100	20	2	○

● Stock ○ Available upon Order

D	Tol
D ≤ 12	0 -0.02
D > 12	0 -0.03

Unit (mm)

Workpiece Material						
P		M	K	N		
1234	5	123	123	123	4	5
Carbon Steel, Alloy Steel (<35HRC)	Alloy Steel, Tool Steel (<48HRC)	Stainless Steel	Cast Iron	Aluminium Alloys	Copper Alloys	Graphite
○	○	○	○			

○ Most Suitable ○ Suitable

Recommended Cutting Data ※ P545

UP210-RH4

4 Flutes, Corner Radius, with Long Shank Length

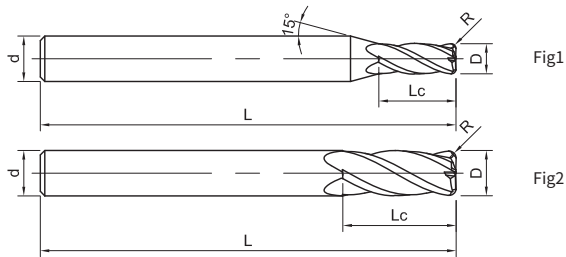

Please refer to page 167

Ordering Code	D	Lc	R	L	d	Figure No.	Stock
UP210-RH4-03005	3	9	0.5	75	4	1	●
UP210-RH4-04005	4	11	0.5	75	4	2	●
UP210-RH4-06005	6	16	0.5	75	6	2	●
UP210-RH4-06005A	6	20	0.5	100	6	2	●
UP210-RH4-06010	6	16	1	75	6	2	●
UP210-RH4-06010A	6	16	1	100	6	2	●
UP210-RH4-06015	6	16	1.5	75	6	2	●
UP210-RH4-08005	8	20	0.5	100	8	2	●
UP210-RH4-08010	8	20	1	100	8	2	●
UP210-RH4-08015	8	20	1.5	100	8	2	●
UP210-RH4-08020	8	20	2	100	8	2	●
UP210-RH4-10005	10	25	0.5	100	10	2	●
UP210-RH4-10010	10	25	1	100	10	2	●
UP210-RH4-10015	10	25	1.5	100	10	2	●
UP210-RH4-10020	10	25	2	100	10	2	●
UP210-RH4-12005	12	30	0.5	100	12	2	●
UP210-RH4-12010	12	30	1	100	12	2	●

● Stock ○ Available upon Order

D	Tol
D ≤ 12	0 -0.02
D > 12	0 -0.03

Unit (mm)

Workpiece Material						
P		M	K	N		
1234	5	123	123	123	4	5
Carbon Steel, Alloy Steel (<35HRC)	Alloy Steel, Tool Steel (<48HRC)	Stainless Steel	Cast Iron	Aluminium Alloys	Copper Alloys	Graphite
○	○	○	○			

○ Most Suitable ○ Suitable

Recommended Cutting Data ※ P545

UP210-RH4

4 Flutes, Corner Radius, with Long Shank Length

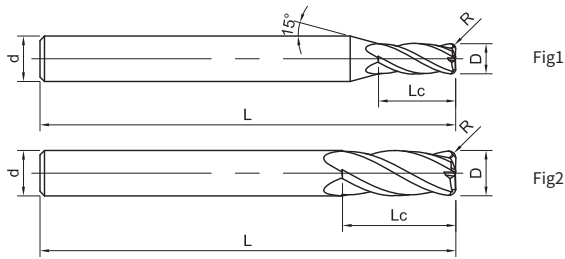

Please refer to page 167

» Continuation

Ordering Code	D	Lc	R	L	d	Figure No.	Stock
UP210-RH4-12015	12	30	1.5	100	12	2	●
UP210-RH4-12020	12	30	2	100	12	2	●
UP210-RH4-12030	12	30	3	100	12	2	●
UP210-RH4-14010	14	36	1	150	14	2	○
UP210-RH4-14020	14	36	2	150	14	2	○
UP210-RH4-16005	16	36	0.5	150	16	2	●
UP210-RH4-16010	16	36	1	150	16	2	●
UP210-RH4-16015	16	36	1.5	150	16	2	●
UP210-RH4-16020	16	36	2	150	16	2	○
UP210-RH4-16030	16	36	3	150	16	2	○
UP210-RH4-18010	18	45	1	150	18	2	●
UP210-RH4-18020	18	45	2	150	18	2	●
UP210-RH4-20010	20	45	1	150	20	2	○
UP210-RH4-20020	20	45	2	150	20	2	●

● Stock ○ Available upon Order

D	Tol
D ≤ 12	0 -0.02
D > 12	0 -0.03

Unit (mm)

Workpiece Material						
P		M	K	N		
1234	5	123	123	123	4	5
Carbon Steel, Alloy Steel (<35HRC)	Alloy Steel, Tool Steel (<48HRC)	Stainless Steel	Cast Iron	Aluminium Alloys	Copper Alloys	Graphite
○	○	○	○			

○ Most Suitable ○ Suitable

Recommended Cutting Data ※ P545

UP210-R4A

4 Flutes, Corner Radius, 45° Helix

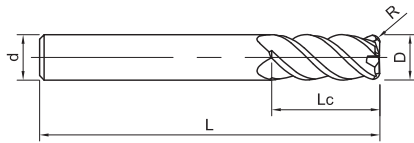

Fig1



Please refer to page 167

Ordering Code	D	Lc	R	L	d	Figure No.	Stock
UP210-R4A-04005	4	11	0.5	50	4	1	●
UP210-R4A-04010	4	11	1	50	4	1	●
UP210-R4A-06005	6	16	0.5	50	6	1	●
UP210-R4A-06010	6	16	1	50	6	1	●
UP210-R4A-06015	6	16	1.5	50	6	1	○
UP210-R4A-08003	8	20	0.3	60	8	1	○
UP210-R4A-08005	8	20	0.5	60	8	1	●
UP210-R4A-08010	8	20	1	60	8	1	●
UP210-R4A-08015	8	20	1.5	60	8	1	●
UP210-R4A-08020	8	20	2	60	8	1	○
UP210-R4A-10002	10	25	0.2	75	10	1	○
UP210-R4A-10005	10	25	0.5	75	10	1	●
UP210-R4A-10010	10	25	1	75	10	1	●
UP210-R4A-10015	10	25	1.5	75	10	1	○
UP210-R4A-10020	10	25	2	75	10	1	○

● Stock ○ Available upon Order

D	Tol
D ≤ 12	0 -0.02
D > 12	0 -0.03

Unit (mm)

Workpiece Material						
P		M	K	N		
1234	5	123	123	123	4	5
Carbon Steel, Alloy Steel (<35HRC)	Alloy Steel, Tool Steel (<48HRC)	Stainless Steel	Cast Iron	Aluminium Alloys	Copper Alloys	Graphite
○	○	○	○			

○ Most Suitable ○ Suitable

Recommended Cutting Data ※ P545

UP210-R4A

4 Flutes, Corner Radius, 45°Helix

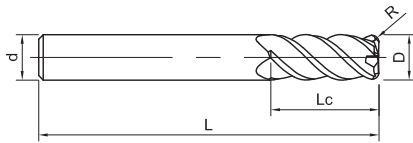

Fig1



Please refer to page 167

» Continuation

Ordering Code	D	Lc	R	L	d	Figure No.	Stock
UP210-R4A-10025	10	25	2.5	75	10	2	●
UP210-R4A-10030	10	25	3	75	10	2	●
UP210-R4A-12005	12	30	0.5	75	12	2	●
UP210-R4A-12010	12	30	1	75	12	2	○
UP210-R4A-12015	12	30	1.5	75	12	2	○
UP210-R4A-12020	12	30	2	75	12	2	○
UP210-R4A-12025	12	30	2.5	75	12	2	○
UP210-R4A-12030	12	30	3	75	12	2	○
UP210-R4A-16005	16	36	0.5	100	16	2	○
UP210-R4A-16010	16	36	1	100	16	2	○
UP210-R4A-16020	16	36	2	100	16	2	○
UP210-R4A-16030	16	36	3	100	16	2	○
UP210-R4A-20010	20	45	1	100	20	2	●
UP210-R4A-20020	20	45	2	100	20	2	○

● Stock ○ Available upon Order

D	Tol
D ≤ 12	0 -0.02
D > 12	0 -0.03

Unit (mm)

Workpiece Material						
P		M	K	N		
1234	5	123	123	123	4	5
Carbon Steel, Alloy Steel (<35HRC)	Alloy Steel, Tool Steel (<48HRC)	Stainless Steel	Cast Iron	Aluminium Alloys	Copper Alloys	Graphite
○	○	○	○			

○ Most Suitable ○ Suitable

Recommended Cutting Data ※ P545

UP210-B2

2 Flutes, Ballnose

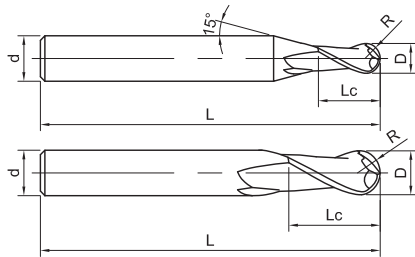

Fig1

Fig2



Please refer to page 167

Ordering Code	D	R	Lc	L	d	Figure No.	Stock
UP210-B2-00801	0.8	0.4	1.6	50	4	1	●
UP210-B2-00901	0.9	0.45	1.8	50	4	1	●
UP210-B2-01002	1	0.5	2	50	4	1	●
UP210-B2-61002	1	0.5	2	50	6	1	●
UP210-B2-01503	1.5	0.75	3	50	4	1	●
UP210-B2-61503	1.5	0.75	3	50	6	1	●
UP210-B2-02004	2	1	4	50	4	1	●
UP210-B2-62004	2	1	4	50	6	1	●
UP210-B2-02505	2.5	1.25	5	50	4	1	●
UP210-B2-03006	3	1.5	6	50	4	1	●
UP210-B2-63006	3	1.5	6	50	6	1	●
UP210-B2-03506	3.5	1.75	6	50	4	1	●
UP210-B2-04008	4	2	8	50	4	2	●
UP210-B2-64008	4	2	8	50	6	1	●
UP210-B2-05010	5	2.5	10	50	6	1	●

● Stock ○ Available upon Order

R	Tol
$R \leq 1.5$	$\begin{matrix} 0 \\ -0.01 \end{matrix}$
$1.5 < R < 3$	$\begin{matrix} 0 \\ -0.015 \end{matrix}$
$R \geq 12$	$\begin{matrix} 0 \\ -0.02 \end{matrix}$

Unit (mm)

Workpiece Material						
P		M	K	N		
1234	5	123	123	123	4	5
Carbon Steel, Alloy Steel (<35HRC)	Alloy Steel, Tool Steel (<48HRC)	Stainless Steel	Cast Iron	Aluminium Alloys	Copper Alloys	Graphite
○	○	○	○			

○ Most Suitable ○ Suitable

Recommended Cutting Data ※ P547

UP210-B2

2 Flutes, Ballnose

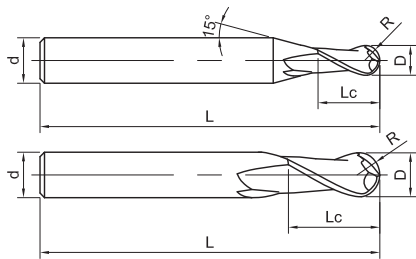

Fig1

Fig2



Please refer to page 167

» Continuation

Ordering Code	D	R	Lc	L	d	Figure No.	Stock
UP210-B2-05510	5.5	2.75	10	50	6	1	●
UP210-B2-06012	6	3	12	50	6	2	●
UP210-B2-06012A	6	3	12	60	6	2	●
UP210-B2-07014	7	3.5	14	60	8	1	●
UP210-B2-08014	8	4	14	60	8	2	●
UP210-B2-09016	9	4.5	16	75	10	1	●
UP210-B2-10018	10	5	18	75	10	2	●
UP210-B2-11020	11	5.5	20	75	12	1	●
UP210-B2-12022	12	6	22	75	12	2	●
UP210-B2-13026	13	6.5	26	90	14	1	○
UP210-B2-14026	14	7	26	90	16	2	●
UP210-B2-15030	15	7.5	30	100	16	1	●
UP210-B2-16030	16	8	30	100	16	2	●
UP210-B2-18034	18	9	34	100	18	2	●
UP210-B2-20038	20	10	38	100	20	2	●

● Stock ○ Available upon Order

R	Tol
R ≤ 1.5	0 -0.01
1.5 < R < 3	0 -0.015
R ≥ 3	0 -0.02

Unit (mm)

Workpiece Material						
P		M	K	N		
1234	5	123	123	123	4	5
Carbon Steel, Alloy Steel (<35HRC)	Alloy Steel, Tool Steel (<48HRC)	Stainless Steel	Cast Iron	Aluminium Alloys	Copper Alloys	Graphite
○	○	○	○			

○ Most Suitable ○ Suitable

Recommended Cutting Data ※ P547

UP210-BH2

2 Flutes, Ballnose, with Long Shank Length

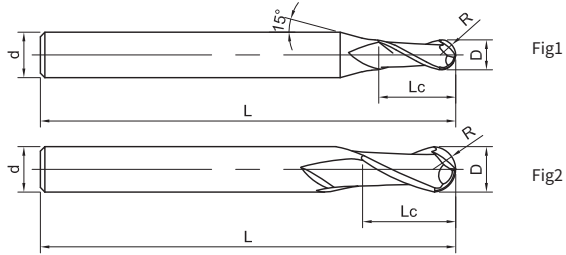

Please refer to page 167

Ordering Code	D	R	Lc	L	d	Figure No.	Stock
UP210-BH2-61002	1	0.5	2	75	6	1	●
UP210-BH2-61503	1.5	0.75	3	75	6	1	●
UP210-BH2-02004	2	1	4	75	4	1	●
UP210-BH2-62004	2	1	4	75	6	1	●
UP210-BH2-03006	3	1.5	6	75	4	1	●
UP210-BH2-63006	3	1.5	6	75	6	1	●
UP210-BH2-04008	4	2	8	75	4	2	●
UP210-BH2-64008	4	2	8	75	6	1	●
UP210-BH2-05010	5	2.5	10	75	6	1	●
UP210-BH2-06012	6	3	12	75	6	2	●
UP210-BH2-06012A	6	3	12	100	6	2	●
UP210-BH2-07014	7	3.5	14	100	8	1	●
UP210-BH2-08014A	8	4	14	75	8	2	●
UP210-BH2-08014	8	4	14	100	8	2	●
UP210-BH2-09016	9	4.5	16	100	10	1	○
UP210-BH2-10018	10	5	18	100	10	2	●

● Stock ○ Available upon Order

R	Tol
$R \leq 1.5$	$\begin{matrix} 0 \\ -0.01 \end{matrix}$
$1.5 < R < 3$	$\begin{matrix} 0 \\ -0.015 \end{matrix}$
$R \geq 3$	$\begin{matrix} 0 \\ -0.02 \end{matrix}$

Unit (mm)

Workpiece Material						
P		M	K	N		
1234	5	123	123	123	4	5
Carbon Steel, Alloy Steel (<35HRC)	Alloy Steel, Tool Steel (<48HRC)	Stainless Steel	Cast Iron	Aluminium Alloys	Copper Alloys	Graphite
○	○	○	○			

○ Most Suitable ○ Suitable

Recommended Cutting Data ※ P547

UP210-BH2

2 Flutes, Ballnose, with Long Shank Length

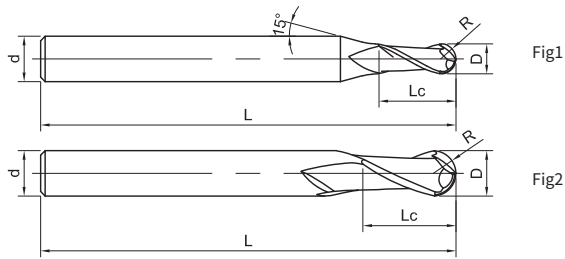

Please refer to page 167

» Continuation

Ordering Code	D	R	Lc	L	d	Figure No.	Stock
UP210-BH2-10018A	10	5	18	150	10	2	●
UP210-BH2-11020	11	5.5	20	100	12	1	●
UP210-BH2-10018A	10	5	18	150	10	2	●
UP210-BH2-12022	12	6	22	100	12	2	●
UP210-BH2-12022A	12	6	22	150	12	2	●
UP210-BH2-14026	14	7	26	150	14	2	○
UP210-BH2-16030	16	8	30	150	16	2	●
UP210-BH2-18034	18	9	34	150	18	2	○
UP210-BH2-20038	20	10	38	150	20	2	●

● Stock ○ Available upon Order

R	Tol
$R \leq 1.5$	$\begin{matrix} 0 \\ -0.01 \end{matrix}$
$1.5 < R < 3$	$\begin{matrix} 0 \\ -0.015 \end{matrix}$
$R \geq 3$	$\begin{matrix} 0 \\ -0.02 \end{matrix}$

Unit (mm)

Workpiece Material						
P		M	K	N		
1234	5	123	123	123	4	5
Carbon Steel, Alloy Steel (<35HRC)	Alloy Steel, Tool Steel (<48HRC)	Stainless Steel	Cast Iron	Aluminium Alloys	Copper Alloys	Graphite
○	○	○	○			

○ Most Suitable ○ Suitable

Recommended Cutting Data ※ P547

UP210-B4

4 Flutes, Ballnose

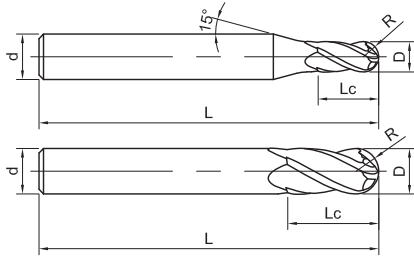

Fig1

Fig2



Please refer to page 167

Ordering Code	D	R	Lc	L	d	Figure No.	Stock
UP210-B4-02004	2	1	4	50	4	1	●
UP210-B4-62004	2	1	4	50	6	1	●
UP210-B4-02505	2.5	1.25	5	50	4	1	●
UP210-B4-03006	3	1.5	6	50	4	1	●
UP210-B4-63006	3	1.5	6	50	6	1	●
UP210-B4-04008	4	2	8	50	4	2	●
UP210-B4-64008	4	2	8	50	6	1	●
UP210-B4-05010	5	2.5	10	50	6	1	●
UP210-B4-06012	6	3	12	50	6	2	●
UP210-B4-07014	7	3.5	14	60	8	1	●
UP210-B4-08014	8	4	14	60	8	2	●
UP210-B4-09016	9	4.5	16	75	10	1	○
UP210-B4-10018	10	5	18	75	10	2	●
UP210-B4-11020	11	5.5	20	75	12	1	○
UP210-B4-12022	12	6	22	75	12	2	●
UP210-B4-14024	14	7	24	75	14	2	○
UP210-B4-16030	16	8	30	100	16	2	●
UP210-B4-18034	18	9	34	100	18	2	○
UP210-B4-20038	20	10	38	100	20	2	●

● Stock ○ Available upon Order

R	Tol
$R \leq 1.5$	0 -0.01
$1.5 < R < 3$	0 -0.015
$R \geq 3$	0 -0.02

Unit (mm)

Workpiece Material

P		M	K	N		
1234	5	123	123	123	4	5
Carbon Steel, Alloy Steel (<35HRC)	Alloy Steel, Tool Steel (<48HRC)	Stainless Steel	Cast Iron	Aluminium Alloys	Copper Alloys	Graphite
○	○	○	○			

○ Most Suitable ○ Suitable

Recommended Cutting Data ※ P547

UP210-L60

4 Flutes, 60° Chamfer Endmills

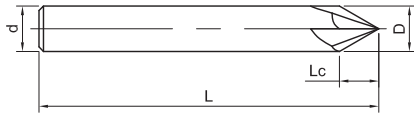

Fig1



Please refer to page 167

Ordering Code	D	Lc	L	d	Figure No.	Stock
UP210-L60-04060	4	3.5	50	4	1	●
UP210-L60-06060	6	5.2	50	6	1	●
UP210-L60-08060	8	7	60	8	1	●
UP210-L60-10060	10	8.7	75	10	1	●
UP210-L60-12060	12	10.4	75	12	1	●
UP210-L60-16060	16	13.9	100	16	1	●
UP210-L60-20060	20	17.4	100	20	1	○

● Stock ○ Available upon Order

D	Tol
D ≤ 12	0 -0.02
D > 12	0 -0.03

Unit (mm)

Workpiece Material						
P		M	K	N		
1234	5	123	123	123	4	5
Carbon Steel, Alloy Steel (<35HRC)	Alloy Steel, Tool Steel (<48HRC)	Stainless Steel	Cast Iron	Aluminium Alloys	Copper Alloys	Graphite
○	○	○	○	○	○	

○ Most Suitable ○ Suitable

Recommended Cutting Data ※ P548

UP210-L90

4 Flutes, 90° Chamfer Endmills

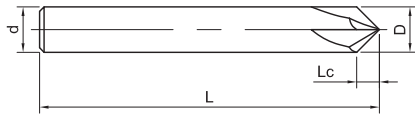

Fig1



Please refer to page 167

Ordering Code	D	Lc	L	d	Figure No.	Stock
UP210-L90-04090	4	2	50	4	1	●
UP210-L90-06090	6	3	50	6	1	●
UP210-L90-08090	8	4	60	8	1	●
UP210-L90-10090	10	5	75	10	1	●
UP210-L90-12090	12	6	75	12	1	●
UP210-L90-16090	16	8	100	16	1	●
UP210-L90-20090	20	10	100	20	1	●

● Stock ○ Available upon Order

D	Tol
D ≤ 12	0 -0.02
D > 12	0 -0.03

Unit (mm)

Workpiece Material						
P		M	K	N		
1234	5	123	123	123	4	5
Carbon Steel, Alloy Steel (<35HRC)	Alloy Steel, Tool Steel (<48HRC)	Stainless Steel	Cast Iron	Aluminium Alloys	Copper Alloys	Graphite
○	○	○	○	○	○	

○ Most Suitable ○ Suitable

Recommended Cutting Data ※ P548

UP210-L120

4 Flutes, 120° Chamfer Endmills

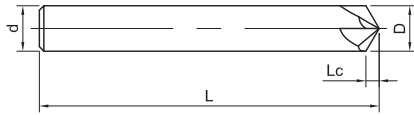

Fig1



Please refer to page 167

Ordering Code	D	Lc	L	d	Figure No.	Stock
UP210-L120-04120	4	1.2	50	4	1	●
UP210-L120-06120	6	1.8	50	6	1	●
UP210-L120-08120	8	2.4	60	8	1	●
UP210-L120-10120	10	2.9	75	10	1	●
UP210-L120-12120	12	3.5	75	12	1	●
UP210-L120-16120	16	4.6	100	16	1	●
UP210-L120-18120	18	5.2	100	18	1	○
UP210-L120-20120	20	5.8	100	20	1	○

● Stock ○ Available upon Order

D	Tol
D ≤ 12	0 -0.02
D > 12	0 -0.03

Unit (mm)

Workpiece Material						
P		M	K	N		
1234	5	123	123	123	4	5
Carbon Steel, Alloy Steel (<35HRC)	Alloy Steel, Tool Steel (<48HRC)	Stainless Steel	Cast Iron	Aluminium Alloys	Copper Alloys	Graphite
○	○	○	○	○	○	

○ Most Suitable ○ Suitable

Recommended Cutting Data ※ P548

SP210-S3

3 Flutes, with Variable Helix, Square

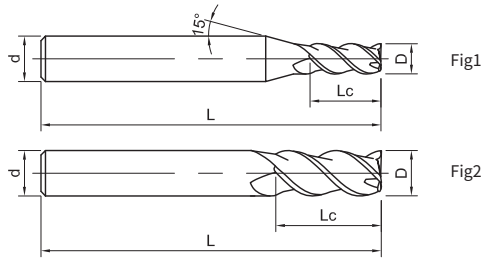

Please refer to page 167

Ordering Code	D	Lc	L	d	Figure No.	Stock
SP210-S3-02508	2.5	8	50	4	1	●
SP210-S3-03009	3	9	50	4	1	●
SP210-S3-04011	4	11	50	4	2	●
SP210-S3-05013	5	13	50	6	1	●
SP210-S3-06016	6	16	50	6	2	●
SP210-S3-08020	8	20	60	8	2	●
SP210-S3-09025	9	25	75	10	1	●
SP210-S3-10025	10	25	75	10	2	●
SP210-S3-12030	12	30	75	12	2	●
SP210-S3-16036	16	36	100	16	2	●
SP210-S3-20045	20	45	100	20	2	●

● Stock ○ Available upon Order

D	Tol
D ≤ 12	0 -0.02
D > 12	0 -0.03

Unit (mm)

Workpiece Material						
P		M	K	N		
1234	5	123	123	123	4	5
Carbon Steel, Alloy Steel (<35HRC)	Alloy Steel, Tool Steel (<48HRC)	Stainless Steel	Cast Iron	Aluminium Alloys	Copper Alloys	Graphite
○	○	○	○			

○ Most Suitable ○ Suitable

Recommended Cutting Data ※ P548

SP210-C3

3 Flutes, Variable Helix with Chamfer, Square

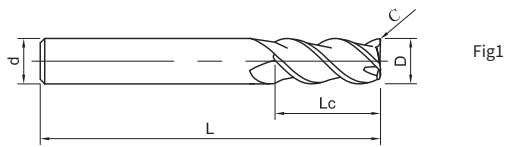

Please refer to page 167

Ordering Code	D	Lc	C	L	d	Figure No.	Stock
SP210-C3-06020	6	16	0.2	50	6	1	●
SP210-C3-08020	8	20	0.2	60	8	1	●
SP210-C3-10030	10	25	0.3	75	10	1	●
SP210-C3-12030	12	30	0.3	75	12	1	●
SP210-C3-16030	16	36	0.3	100	16	1	○

● Stock ○ Available upon Order

D	Tol
D ≤ 12	0 -0.02
D > 12	0 -0.03

Unit (mm)

Workpiece Material						
P		M	K	N		
1234	5	123	123	123	4	5
Carbon Steel, Alloy Steel (<35HRC)	Alloy Steel, Tool Steel (<48HRC)	Stainless Steel	Cast Iron	Aluminium Alloys	Copper Alloys	Graphite
○	○	○	○			

○ Most Suitable ○ Suitable

Recommended Cutting Data ※ P548

SP210-S4

4 Flutes, with Variable Helix, Square

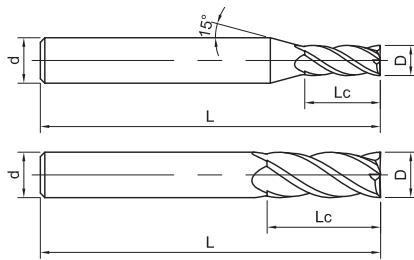

Fig1

Fig2



Please refer to page 167

Ordering Code	D	Lc	L	d	Figure No.	Stock
SP210-S4-02006	2	6	50	4	1	●
SP210-S4-62006	2	6	50	6	1	●
SP210-S4-02508	2.5	8	50	4	1	●
SP210-S4-03009	3	9	50	4	1	●
SP210-S4-63009	3	9	50	6	1	●
SP210-S4-04011	4	11	50	4	2	●
SP210-S4-64011	4	11	50	6	1	●
SP210-S4-05013	5	13	50	6	1	●
SP210-S4-05516	5.5	16	50	6	1	○
SP210-S4-06016	6	16	50	6	2	●
SP210-S4-07020	7	20	60	8	1	●
SP210-S4-08020	8	20	60	8	2	●
SP210-S4-08025	8	25	60	8	2	●
SP210-S4-10025	10	25	75	10	2	●
SP210-S4-12030	12	30	75	12	2	●
SP210-S4-14034	14	34	100	14	2	○
SP210-S4-16036	16	36	100	16	2	●
SP210-S4-20045	20	45	100	20	2	●

● Stock ○ Available upon Order

D	Tol
D ≤ 12	0 -0.02
D > 12	0 -0.03

Unit (mm)

Workpiece Material						
P		M	K	N		
1234	5	123	123	123	4	5
Carbon Steel, Alloy Steel (<35HRC)	Alloy Steel, Tool Steel (<48HRC)	Stainless Steel	Cast Iron	Aluminium Alloys	Copper Alloys	Graphite
○	○	○	○			

○ Most Suitable ○ Suitable

Recommended Cutting Data ※ P549

SP210-C4

4 Flutes, Variable Helix with Chamfer, Square

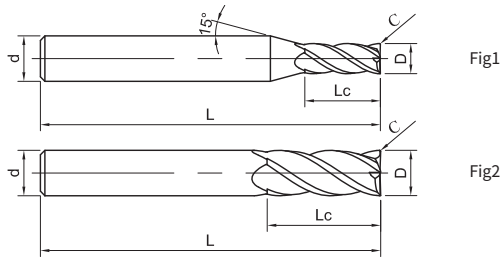

Please refer to page 167

Ordering Code	D	Lc	C	L	d	Figure No.	Stock
SP210-C4-03003	3	9	0.03	50	4	1	●
SP210-C4-03013	3	9	0.13	50	4	1	●
SP210-C4-63008	3	8	0.15	57	6	1	●
SP210-C4-64011	4	11	0.18	57	6	1	●
SP210-C4-04004	4	11	0.04	50	4	2	●
SP210-C4-04018	4	11	0.18	50	4	2	●
SP210-C4-05005	5	13	0.05	50	6	1	●
SP210-C4-05013	5	13	0.15	57	6	1	●
SP210-C4-05020	5	13	0.2	50	6	1	●
SP210-C4-06006	6	16	0.06	50	6	2	●
SP210-C4-06013	6	13	0.2	57	6	2	●
SP210-C4-06020	6	16	0.2	50	6	2	●
SP210-C4-06040	6	16	0.4	50	6	2	●
SP210-C4-08008	8	20	0.08	60	8	2	●
SP210-C4-08019	8	19	0.2	63	8	2	○
SP210-C4-08020	8	20	0.2	60	8	2	●
SP210-C4-10010	10	25	0.1	75	10	2	●
SP210-C4-10022	10	22	0.3	72	10	2	●

● Stock ○ Available upon Order

D	Tol
D ≤ 12	0 -0.02
D > 12	0 -0.03

Unit (mm)

Workpiece Material						
P		M	K	N		
1234	5	123	123	123	4	5
Carbon Steel, Alloy Steel (<35HRC)	Alloy Steel, Tool Steel (<48HRC)	Stainless Steel	Cast Iron	Aluminium Alloys	Copper Alloys	Graphite
○	○	○	○			

○ Most Suitable ○ Suitable

Recommended Cutting Data ※ P549

SP210-C4

4 Flutes, Variable Helix with Chamfer, Square

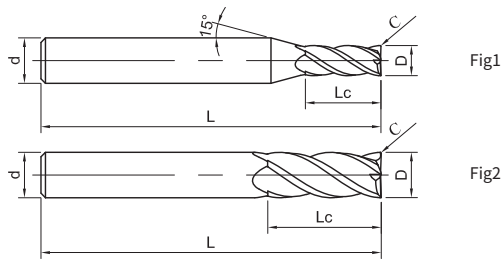

Please refer to page 167

» Continuation

Ordering Code	D	Lc	C	L	d	Figure No.	Stock
SP210-C4-10030	10	25	0.3	75	10	2	●
SP210-C4-12012	12	30	0.12	75	12	2	●
SP210-C4-12026	12	26	0.3	83	12	2	●
SP210-C4-12030	12	30	0.3	75	12	2	●
SP210-C4-16015	16	36	0.15	100	16	2	○
SP210-C4-16040	16	36	0.4	100	16	2	○
SP210-C4-18015	18	45	0.15	100	18	2	●
SP210-C4-20015	20	45	0.15	100	20	2	●
SP210-C4-20050	20	45	0.5	100	20	2	○

● Stock ○ Available upon Order

D	Tol
D ≤ 12	0 -0.02
D > 12	0 -0.03

Unit (mm)

Workpiece Material						
P		M	K	N		
1234	5	123	123	123	4	5
Carbon Steel, Alloy Steel (<35HRC)	Alloy Steel, Tool Steel (<48HRC)	Stainless Steel	Cast Iron	Aluminium Alloys	Copper Alloys	Graphite
○	○	○	○			

○ Most Suitable ○ Suitable

Recommended Cutting Data ※ P549

SP210-CN4

4 Flutes, Long Neck, Variable Helix with Chamfer, Square

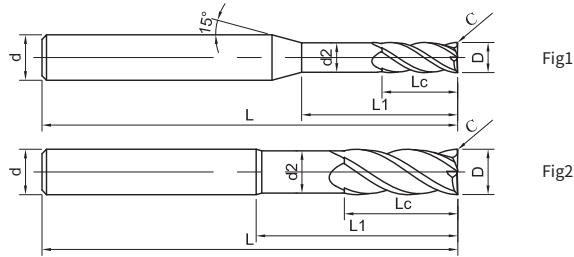

Please refer to page 167

Ordering Code	D	Lc	C	d2	L1	L	d	Figure No.	Stock
SP210-CN4-03013	3	10	0.13	2.9	18	75	4	1	●
SP210-CN4-04018	4	12	0.18	3.8	20	75	4	2	●
SP210-CN4-05020	5	15	0.2	4.8	35	75	6	1	○
SP210-CN4-06020	6	16	0.2	5.8	24	100	6	2	●
SP210-CN4-08020	8	20	0.2	7.5	30	100	8	2	●
SP210-CN4-10030	10	25	0.3	9.5	40	150	10	2	●
SP210-CN4-12030	12	30	0.3	11	40	150	12	2	●
SP210-CN4-16040	16	36	0.4	15	50	150	16	2	○
SP210-CN4-20050	20	45	0.5	19	60	150	20	2	○

● Stock ○ Available upon Order

D	Tol
D ≤ 12	0 -0.02
D > 12	0 -0.03

Unit (mm)

Workpiece Material						
P		M	K	N		
1234	5	123	123	123	4	5
Carbon Steel, Alloy Steel (<35HRC)	Alloy Steel, Tool Steel (<48HRC)	Stainless Steel	Cast Iron	Aluminium Alloys	Copper Alloys	Graphite
○	○	○	○			

○ Most Suitable ○ Suitable

Recommended Cutting Data ※ P549

SP210-R4

4 Flutes, Corner Radius, Variable Helix

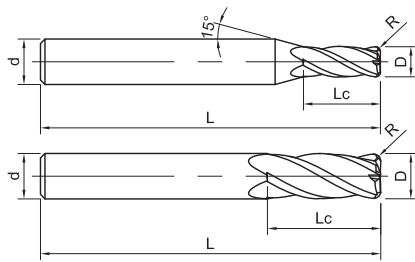
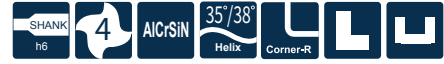

Fig1

Fig2



Please refer to page 167

Ordering Code	D	Lc	R	L	d	Figure No.	Stock
SP210-R4-02005	2	6	0.5	50	4	1	●
SP210-R4-03002	3	9	0.2	50	4	1	●
SP210-R4-03003	3	9	0.3	50	4	1	●
SP210-R4-03005	3	9	0.5	50	4	1	●
SP210-R4-04003	4	11	0.3	50	4	2	●
SP210-R4-04005	4	11	0.5	50	4	2	●
SP210-R4-04010	4	11	1	50	4	2	●
SP210-R4-05003	5	13	0.3	50	6	1	○
SP210-R4-05005	5	13	0.5	50	6	1	●
SP210-R4-05010	5	13	1	50	6	1	●
SP210-R4-06003	6	16	0.3	50	6	2	●
SP210-R4-06005	6	16	0.5	50	6	2	●
SP210-R4-06010	6	16	1	50	6	2	●
SP210-R4-06015	6	16	1.5	50	6	2	●
SP210-R4-06020	6	16	2	50	6	2	●
SP210-R4-08005	8	20	0.5	60	8	2	●

● Stock ○ Available upon Order

D	Tol
D ≤ 12	0 -0.02
D > 12	0 -0.03

Unit (mm)

Workpiece Material						
P		M	K	N		
1234	5	123	123	123	4	5
Carbon Steel, Alloy Steel (<35HRC)	Alloy Steel, Tool Steel (<48HRC)	Stainless Steel	Cast Iron	Aluminium Alloys	Copper Alloys	Graphite
○	○	○	○			

○ Most Suitable ○ Suitable

Recommended Cutting Data ※ P549

SP210-R4

4 Flutes, Corner Radius, Variable Helix

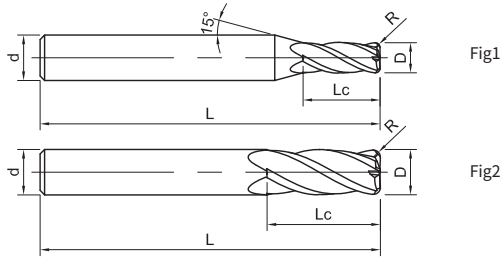

Please refer to page 167

» Continuation

Ordering Code	D	Lc	R	L	d	Figure No.	Stock
SP210-R4-08010	8	20	1.0	60	8	2	●
SP210-R4-08015	8	20	1.5	60	8	2	●
SP210-R4-08020	8	20	2	60	8	2	○
SP210-R4-10005	10	25	0.5	75	10	2	●
SP210-R4-10010	10	25	1	75	10	2	●
SP210-R4-10015	10	25	1.5	75	10	2	●
SP210-R4-10020	10	25	2	75	10	2	●
SP210-R4-10030	10	25	3	75	10	2	●
SP210-R4-12005	12	30	0.5	75	12	2	●
SP210-R4-12010	12	30	1	75	12	2	●
SP210-R4-12015	12	30	1.5	75	12	2	●
SP210-R4-12020	12	30	2	75	12	2	●
SP210-R4-12030	12	30	3	75	12	2	●
SP210-R4-14020	14	32	2	75	14	2	●
SP210-R4-16020	16	36	2	100	16	2	○
SP210-R4-16030	16	36	3	100	16	2	●

● Stock ○ Available upon Order

D	Tol
D ≤ 12	0 -0.02
D > 12	0 -0.03

Unit (mm)

Workpiece Material						
P		M	K	N		
1234	5	123	123	123	4	5
Carbon Steel, Alloy Steel (<35HRC)	Alloy Steel, Tool Steel (<48HRC)	Stainless Steel	Cast Iron	Aluminium Alloys	Copper Alloys	Graphite
○	○	○	○			

○ Most Suitable ○ Suitable

Recommended Cutting Data ※ P549

SP210-RH4

4 Flutes, Corner Radius, Variable Helix, with Long Shank Length

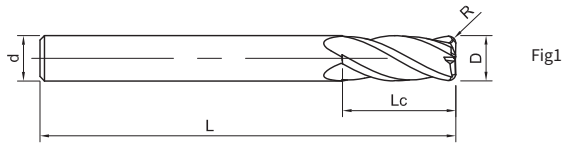

Please refer to page 167

Ordering Code	D	Lc	R	L	d	Figure No.	Stock
SP210-RH4-04005	4	11	0.5	75	4	1	●
SP210-RH4-06005	6	16	0.5	75	6	1	●
SP210-RH4-08005	8	20	0.5	100	8	1	●
SP210-RH4-08005A	8	20	0.5	75	8	1	●
SP210-RH4-08010	8	20	1	100	8	1	●
SP210-RH4-08010A	8	20	1	75	8	1	●
SP210-RH4-10005	10	25	0.5	100	10	1	●
SP210-RH4-10010	10	25	1	100	10	1	●
SP210-RH4-12005	12	30	0.5	100	12	1	●
SP210-RH4-12010	12	30	1	100	12	1	●
SP210-RH4-12030	12	30	3	100	12	1	○

● Stock ○ Available upon Order

D	Tol
D ≤ 12	0 -0.02
D > 12	0 -0.03

Unit (mm)

Workpiece Material						
P		M	K	N		
1234	5	123	123	123	4	5
Carbon Steel, Alloy Steel (<35HRC)	Alloy Steel, Tool Steel (<48HRC)	Stainless Steel	Cast Iron	Aluminium Alloys	Copper Alloys	Graphite
○	○	○	○			

○ Most Suitable ○ Suitable

Recommended Cutting Data ※ P549

SP210-B2

2 Flutes, Ballnose

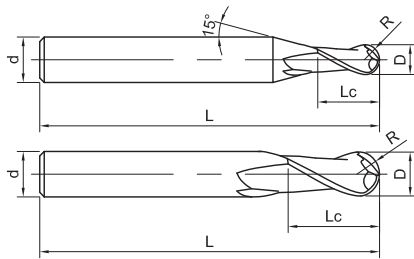

Fig1

Fig2



Please refer to page 167

Ordering Code	D	R	Lc	L	d	Figure No.	Stock
SP210-B2-01002	1	0.5	2	50	4	1	●
SP210-B2-61002	1	0.5	2	50	6	1	●
SP210-B2-01503	1.5	0.75	3	50	4	1	●
SP210-B2-61503	1.5	0.75	3	50	6	1	●
SP210-B2-02004	2	1	4	50	4	1	●
SP210-B2-62004	2	1	4	50	6	1	●
SP210-B2-02505	2.5	1.25	5	50	4	1	●
SP210-B2-03006	3	1.5	6	50	4	1	●
SP210-B2-63006	3	1.5	6	50	6	1	○
SP210-B2-03506	3.5	1.75	6	50	4	1	●
SP210-B2-04008	4	2	8	50	4	2	●
SP210-B2-64008	4	2	8	50	6	1	○
SP210-B2-05010	5	2.5	10	50	6	1	●
SP210-B2-06012	6	3	12	50	6	2	●
SP210-B2-06012A	6	3	12	60	6	2	●
SP210-B2-08014	8	4	14	60	8	2	●
SP210-B2-10018	10	5	18	75	10	2	●
SP210-B2-11020	11	5.5	20	75	12	1	●
SP210-B2-12022	12	6	22	75	12	2	●

● Stock ○ Available upon Order

R	Tol
$R \leq 1.5$	$\begin{matrix} 0 \\ -0.01 \end{matrix}$
$1.5 < R < 3$	$\begin{matrix} 0 \\ -0.015 \end{matrix}$
$R \geq 3$	$\begin{matrix} 0 \\ -0.02 \end{matrix}$

Unit (mm)

Workpiece Material						
P		M	K	N		
1234	5	123	123	123	4	5
Carbon Steel, Alloy Steel (<35HRC)	Alloy Steel, Tool Steel (<48HRC)	Stainless Steel	Cast Iron	Aluminium Alloys	Copper Alloys	Graphite
○	○	○	○			

○ Most Suitable ○ Suitable

Recommended Cutting Data ※ P550

SP210-BH2

2 Flutes, Ballnose, with Long Shank Length

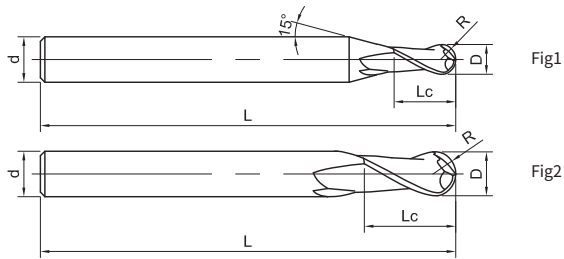

Please refer to page 167

Ordering Code	D	R	Lc	L	d	Figure No.	Stock
SP210-BH2-61002	1	0.5	2	75	6	1	●
SP210-BH2-61503	1.5	0.75	3	75	6	1	●
SP210-BH2-02004	2	1	4	75	4	1	○
SP210-BH2-62004	2	1	4	75	6	1	●
SP210-BH2-63006	3	1.5	6	75	6	1	●
SP210-BH2-04008	4	2	8	75	4	2	●
SP210-BH2-04008A	4	2	8	100	4	2	●
SP210-BH2-64008	4	2	8	75	6	1	●
SP210-BH2-06012	6	3	12	75	6	2	●
SP210-BH2-06012A	6	3	12	100	6	2	●
SP210-BH2-08014	8	4	14	75	8	2	●
SP210-BH2-08014A	8	4	14	100	8	2	●
SP210-BH2-10018	10	5	18	100	10	2	●
SP210-BH2-12022	12	6	22	100	12	2	●

● Stock ○ Available upon Order

R	Tol
$R \leq 1.5$	$\begin{matrix} 0 \\ -0.01 \end{matrix}$
$1.5 < R < 3$	$\begin{matrix} 0 \\ -0.015 \end{matrix}$
$R \geq 3$	$\begin{matrix} 0 \\ -0.02 \end{matrix}$

Unit (mm)

Workpiece Material						
P		M	K	N		
1234	5	123	123	123	4	5
Carbon Steel, Alloy Steel (<35HRC)	Alloy Steel, Tool Steel (<48HRC)	Stainless Steel	Cast Iron	Aluminium Alloys	Copper Alloys	Graphite
○	○	○	○			

○ Most Suitable ○ Suitable

Recommended Cutting Data ※ P550

PP300-C2

2 Flutes, Square (Chamfer on Tip)

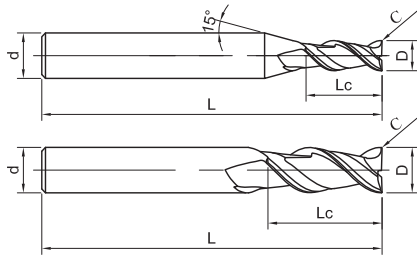

Fig1

Fig2



Please refer to page 167

Ordering Code	D	Lc	C	L	d	Figure No.	Stock
PP300-C2-02002	2	6	0.02	50	4	1	●
PP300-C2-02503	2.5	8	0.03	50	4	1	○
PP300-C2-03003	3	9	0.03	50	4	1	●
PP300-C2-04004	4	11	0.04	50	4	2	●
PP300-C2-05005	5	13	0.05	50	6	1	○
PP300-C2-06006	6	16	0.06	50	6	2	●
PP300-C2-08008	8	20	0.08	60	8	2	●
PP300-C2-10010	10	25	0.1	75	10	2	○
PP300-C2-12012	12	30	0.12	75	12	2	○

● Stock ○ Available upon Order

D	Tol
D ≤ 12	0 -0.02
D > 12	0 -0.03

Unit (mm)

Workpiece Material						
P		M	K	N		
1234	5	123	123	123	4	5
Carbon Steel, Alloy Steel (<35HRC)	Alloy Steel, Tool Steel (<48HRC)	Stainless Steel	Cast Iron	Aluminium Alloys	Copper Alloys	Graphite
○	○	○	○			

○ Most Suitable ○ Suitable

Recommended Cutting Data ※ P551

PP300-C3

3 Flutes, Square, with Variable Helix (Chamfer on Tip)

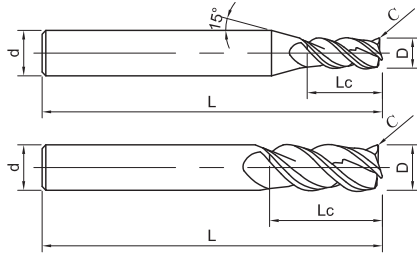

Fig1

Fig2



Please refer to page 167

Ordering Code	D	Lc	C	L	d	Figure No.	Stock
PP300-C3-63003	3	9	0.03	50	6	1	●
PP300-C3-04004	4	11	0.04	50	4	2	●
PP300-C3-64004	4	11	0.04	50	6	1	●
PP300-C3-05005	5	13	0.05	50	6	1	●
PP300-C3-06006	6	16	0.06	50	6	2	○
PP300-C3-06020	6	16	0.2	50	6	2	○
PP300-C3-08008	8	20	0.08	60	8	2	●
PP300-C3-08020	8	20	0.2	60	8	2	○
PP300-C3-10010	10	25	0.1	75	10	2	●
PP300-C3-10030	10	25	0.3	75	10	2	○
PP300-C3-12012	12	30	0.12	75	12	2	○
PP300-C3-12030	12	30	0.3	75	12	2	○
PP300-C3-16015	16	36	0.15	100	16	2	●
PP300-C3-16040	16	36	0.4	100	16	2	○
PP300-C3-20015	20	45	0.15	100	20	2	○
PP300-C3-20050	20	45	0.5	100	20	2	○

● Stock ○ Available upon Order

D	Tol
D ≤ 12	0 -0.02
D > 12	0 -0.03

Unit (mm)

Workpiece Material						
P		M	K	N		
1234	5	123	123	123	4	5
Carbon Steel, Alloy Steel (<35HRC)	Alloy Steel, Tool Steel (<48HRC)	Stainless Steel	Cast Iron	Aluminium Alloys	Copper Alloys	Graphite
○	○	○	○			

○ Most Suitable ○ Suitable

Recommended Cutting Data ※ P552

PP300-C4

4 Flutes, Square, with Variable Helix (Chamfer on Tip)

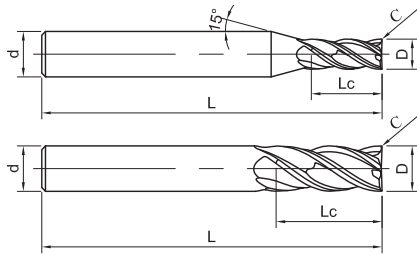

Fig1

Fig2



Please refer to page 167

Ordering Code	D	Lc	C	L	d	Figure No.	Stock
PP300-C4-03003	3	9	0.03	50	4	1	○
PP300-C4-63003	3	9	0.03	50	6	1	○
PP300-C4-03013	3	9	0.13	50	4	1	○
PP300-C4-04004	4	11	0.04	50	4	2	●
PP300-C4-64004	4	11	0.04	50	6	1	●
PP300-C4-04018	4	11	0.18	50	4	2	○
PP300-C4-05005	5	13	0.05	50	6	1	●
PP300-C4-05020	5	13	0.2	50	6	1	○
PP300-C4-06006	6	16	0.06	50	6	2	●
PP300-C4-06020	6	16	0.2	50	6	2	○
PP300-C4-08008	8	20	0.08	60	8	2	●
PP300-C4-08020	8	20	0.2	60	8	2	○
PP300-C4-10010	10	25	0.1	75	10	2	●
PP300-C4-10030	10	25	0.3	75	10	2	○
PP300-C4-12012	12	30	0.12	75	12	2	●
PP300-C4-12030	12	30	0.3	75	12	2	○
PP300-C4-16015	16	36	0.15	100	16	2	●
PP300-C4-16040	16	36	0.4	100	16	2	○
PP300-C4-20015	20	45	0.15	100	20	2	○
PP300-C4-20050	20	45	0.5	100	20	2	○

● Stock ○ Available upon Order

D	Tol
D ≤ 12	0 -0.02
D > 12	0 -0.03

Unit (mm)

Workpiece Material						
P		M	K	N		
1234	5	123	123	123	4	5
Carbon Steel, Alloy Steel (<35HRC)	Alloy Steel, Tool Steel (<48HRC)	Stainless Steel	Cast Iron	Aluminium Alloys	Copper Alloys	Graphite
○	○	○	○			

○ Most Suitable ○ Suitable

Recommended Cutting Data ※ P553

PP300-R4

4 Flutes, Corner Radius, with Variable Helix

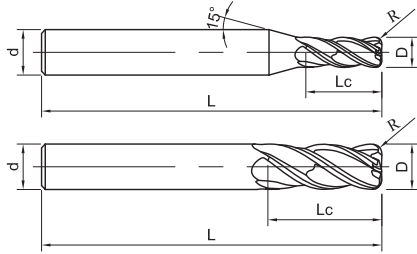

Fig1

Fig2



Please refer to page 167

Ordering Code	D	Lc	R	L	d	Figure No.	Stock
PP300-R4-03005	3	9	0.5	50	4	1	○
PP300-R4-04003	4	11	0.3	50	4	2	○
PP300-R4-04005	4	11	0.5	50	4	2	●
PP300-R4-04010	4	11	1	50	4	2	○
PP300-R4-05005	5	13	0.5	50	6	1	○
PP300-R4-06005	6	16	0.5	50	6	2	●
PP300-R4-06010	6	16	1	50	6	2	●
PP300-R4-06020	6	16	2	50	6	2	○
PP300-R4-08005	8	20	0.5	60	8	2	●
PP300-R4-08010	8	20	1	60	8	2	●
PP300-R4-10005	10	25	0.5	75	10	2	●
PP300-R4-10010	10	25	1	75	10	2	●
PP300-R4-10015	10	25	1.5	75	10	2	●
PP300-R4-10020	10	25	2	75	10	2	○
PP300-R4-10030	10	25	3	75	10	2	●

●Stock ○Available upon Order

D	Tol
D≤12	0 -0.02
D>12	0 -0.03

Unit (mm)

Workpiece Material						
P		M	K	N		
1234	5	123	123	123	4	5
Carbon Steel, Alloy Steel (<35HRC)	Alloy Steel, Tool Steel (<48HRC)	Stainless Steel	Cast Iron	Aluminium Alloys	Copper Alloys	Graphite
○	○	○	○			

○ Most Suitable ○ Suitable

Recommended Cutting Data ※ P553

PP300-R4

4 Flutes, Corner Radius, with Variable Helix

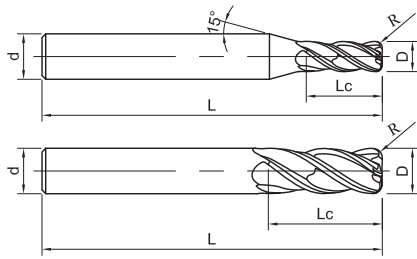

Fig1

Fig2



Please refer to page 167

» Continuation

Ordering Code	D	Lc	R	L	d	Figure No.	Stock
PP300-R4-12005	12	30	0.5	75	12	2	●
PP300-R4-12010	12	30	1	75	12	2	●
PP300-R4-12015	12	30	1.5	75	12	2	●
PP300-R4-12020	12	30	2	75	12	2	●
PP300-R4-12030	12	30	3	75	12	2	●
PP300-R4-16010	16	36	1	100	16	2	●
PP300-R4-16020	16	36	2	100	16	2	●
PP300-R4-16030	16	36	3	100	16	2	○
PP300-R4-20010	20	45	1	100	20	2	●
PP300-R4-20020	20	45	2	100	20	2	●

● Stock ○ Available upon Order

D	Tol
D ≤ 12	0 -0.02
D > 12	0 -0.03

Unit (mm)

Workpiece Material						
P		M	K	N		
1234	5	123	123	123	4	5
Carbon Steel, Alloy Steel (<35HRC)	Alloy Steel, Tool Steel (<48HRC)	Stainless Steel	Cast Iron	Aluminium Alloys	Copper Alloys	Graphite
○	○	○	○			

○ Most Suitable ○ Suitable

Recommended Cutting Data ※ P553

PP300-SPEED-3D

4/5 Flutes, Square, with Variable Helix (Round Corner on Tip)

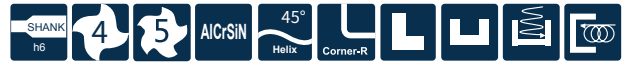
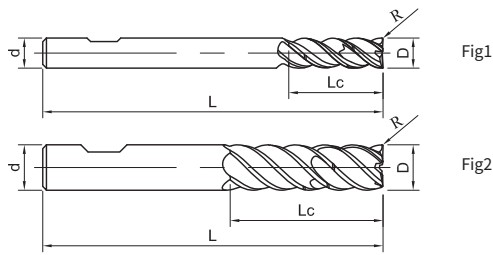

Please refer to page 167

Ordering Code	D	Z	Lc	R	L	d	Figure No.	Stock
PP300-SPEED-3D-06020	6	4	20	0.1	57	6	1	●
PP300-SPEED-3D-08026	8	4	26	0.1	63	8	1	○
PP300-SPEED-3D-10032	10	5	32	0.1	72	10	2	●
PP300-SPEED-3D-12038	12	5	38	0.12	83	12	2	●
PP300-SPEED-3D-14044	14	5	44	0.15	100	14	2	○
PP300-SPEED-3D-16052	16	5	52	0.15	115	16	2	○
PP300-SPEED-3D-20062	20	5	62	0.2	131	20	2	●

● Stock ○ Available upon Order

D	Tol
D ≤ 10	0 -0.04
D > 10	0 -0.05

Unit (mm)

Workpiece Material						
P		M	K	N		
1234	5	123	123	123	4	5
Carbon Steel, Alloy Steel (<35HRC)	Alloy Steel, Tool Steel (<48HRC)	Stainless Steel	Cast Iron	Aluminium Alloys	Copper Alloys	Graphite
○	○	○	○			

○ Most Suitable ○ Suitable

Recommended Cutting Data ※ P554

PP300-SPEED-3DN

4/5 Flutes, Square, with Variable Helix, Long Neck (Round Corner on Tip)

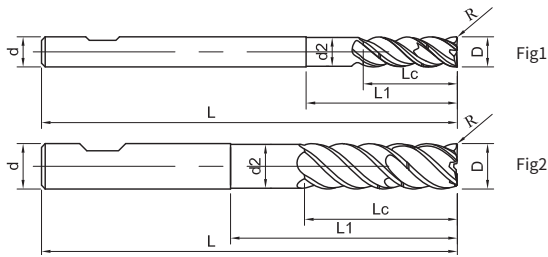

Please refer to page 167

Ordering Code	D	Z	Lc	R	L1	d2	L	d	Figure No.	Stock
PP300-SPEED-3DN-06020	6	4	20	0.1	32	5.8	75	6	1	●
PP300-SPEED-3DN-08026	8	4	26	0.1	42	7.8	85	8	1	●
PP300-SPEED-3DN-10032	10	5	32	0.1	52	9.8	100	10	2	●
PP300-SPEED-3DN-12038	12	5	38	0.12	62	11.8	110	12	2	●
PP300-SPEED-3DN-14044	14	5	44	0.15	72	13.8	125	14	2	○
PP300-SPEED-3DN-16052	16	5	52	0.15	82	15.7	140	16	2	○
PP300-SPEED-3DN-20062	20	5	62	0.2	102	19.7	165	20	2	●

● Stock ○ Available upon Order

D	Tol
D ≤ 10	0 -0.04
D > 10	0 -0.05

Unit (mm)

Workpiece Material						
P		M	K	N		
1234	5	123	123	123	4	5
Carbon Steel, Alloy Steel (<35HRC)	Alloy Steel, Tool Steel (<48HRC)	Stainless Steel	Cast Iron	Aluminium Alloys	Copper Alloys	Graphite
○	○	○	○			

○ Most Suitable ○ Suitable

Recommended Cutting Data ※ P554

PP300-SPEED-5D

4/5 Flutes, Square, with Variable Helix (Round Corner on Tip)

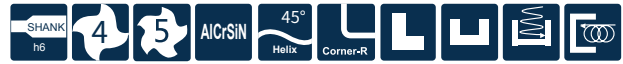
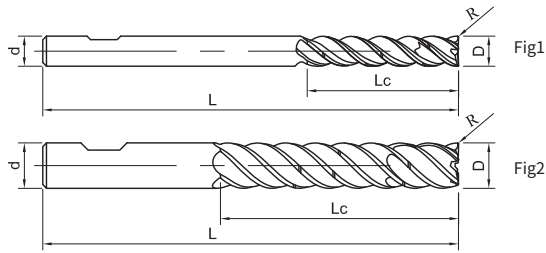

Please refer to page 167

Ordering Code	D	Z	Lc	R	L	d	Figure No.	Stock
PP300-SPEED-5D-06032	6	4	32	0.1	75	6	1	○
PP300-SPEED-5D-08042	8	4	42	0.1	85	8	1	●
PP300-SPEED-5D-10052	10	5	52	0.1	100	10	2	●
PP300-SPEED-5D-12062	12	5	62	0.12	110	12	2	●
PP300-SPEED-5D-14072	14	5	72	0.15	125	14	2	○
PP300-SPEED-5D-16082	16	5	82	0.15	140	16	2	●
PP300-SPEED-5D-200102	20	5	102	0.2	165	20	2	○

● Stock ○ Available upon Order

D	Tol
D ≤ 10	0 -0.04
D > 10	0 -0.05

Unit (mm)

Workpiece Material						
P		M	K	N		
1234	5	123	123	123	4	5
Carbon Steel, Alloy Steel (<35HRC)	Alloy Steel, Tool Steel (<48HRC)	Stainless Steel	Cast Iron	Aluminium Alloys	Copper Alloys	Graphite
○	○	○	○			

○ Most Suitable ○ Suitable

Recommended Cutting Data ※ P554

UPN210-S4

4 Flutes, Square for Roughing Process

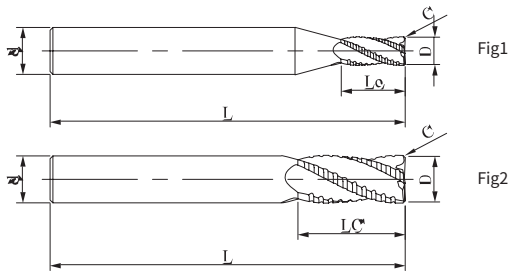

Please refer to page 167

Ordering Code	D	Lc	C	L	d	Figure No.	Stock
UPN210-S4-06016	6	16	0.2	50	6	2	●
UPN210-S4-08020	8	20	0.2	60	8	2	●
UPN210-S4-10025	10	25	0.3	75	10	2	●
UPN210-S4-12030	12	30	0.3	75	12	2	●
UPN210-S4-16036	16	36	0.4	100	16	2	●
UPN210-S4-20045	20	45	0.5	100	20	2	●

● Stock ○ Available upon Order

D	Tol
D ≤ 6	0 -0.03
6 < D ≤ 10	0 -0.04
D > 10	0 -0.05

Unit (mm)

Workpiece Material						
P		M	K	N		
1234	5	123	123	123	4	5
Carbon Steel, Alloy Steel (<35HRC)	Alloy Steel, Tool Steel (<48HRC)	Stainless Steel	Cast Iron	Aluminium Alloys	Copper Alloys	Graphite
○	○	○	○	○	○	

○ Most Suitable ○ Suitable

Recommended Cutting Data ※ P556

UPR210-S4

4 Flutes, Square for Roughing Process

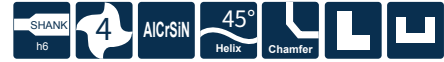
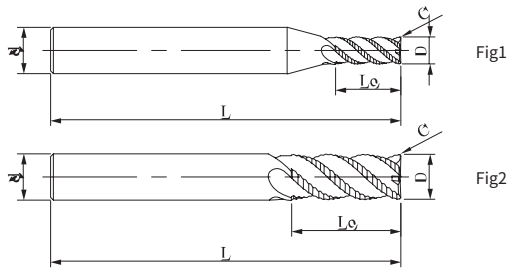

Please refer to page 167

Ordering Code	D	Lc	C	L	d	Figure No.	Stock
UPR210-S4-06016	6	16	0.2	50	6	2	●
UPR210-S4-08020	8	20	0.2	60	8	2	●
UPR210-S4-10025	10	25	0.3	75	10	2	●
UPR210-S4-12030	12	30	0.3	75	12	2	●
UPR210-S4-16036	16	36	0.4	100	16	2	●
UPR210-S4-20045	20	45	0.5	100	20	2	●

● Stock ○ Available upon Order

D	Tol
D ≤ 6	0 -0.03
6 < D ≤ 10	0 -0.04
D > 10	0 -0.05

Unit (mm)

Workpiece Material						
P		M	K	N		
1234	5	123	123	123	4	5
Carbon Steel, Alloy Steel (<35HRC)	Alloy Steel, Tool Steel (<48HRC)	Stainless Steel	Cast Iron	Aluminium Alloys	Copper Alloys	Graphite
○	○	○	○	○	○	

○ Most Suitable ○ Suitable

Recommended Cutting Data ※ P555

UPR300-S3/S4

3/4 Flutes, Square for Roughing Process

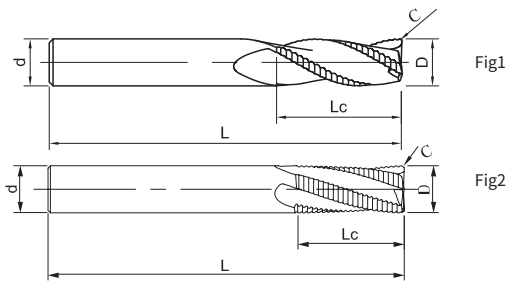

Please refer to page 167

Ordering Code	D	Z	Lc	C	L	d	Figure No.	Stock
UPR300-S3-06016	6	3	16	0.2	50	6	1	●
UPR300-S3-08020	8	3	20	0.2	60	8	1	●
UPR300-S4-10025	10	4	25	0.3	75	10	2	●
UPR300-S4-12030	12	4	30	0.3	75	12	2	●
UPR300-S4-16036	16	4	36	0.4	100	16	2	○
UPR300-S4-20045	20	4	45	0.5	100	20	2	○

● Stock ○ Available upon Order

D	Tol
D ≤ 6	0 -0.03
6 < D ≤ 10	0 -0.04
D > 10	0 -0.05

Unit (mm)

Workpiece Material					
P		M	K	H	
1234	5	123	123	1	23
Carbon Steel, Alloy Steel (<35HRC)	Alloy Steel, Tool Steel (<48HRC)	Stainless Steel	Cast Iron	Hardened Steel (45-55HRC)	Hardened Steel (>55HRC)
○	○	○	○	○	

○ Most Suitable ○ Suitable

Recommended Cutting Data ※ P557

US200-S2

2 Flutes, Standard Length, Square

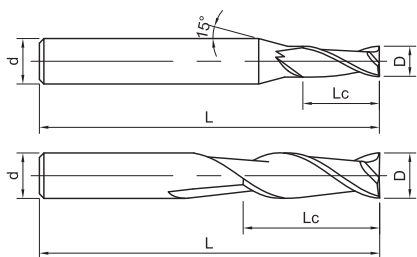

Fig1

Fig2



Please refer to page 167

Ordering Code	D	Lc	L	d	Figure No.	Stock
US200-S2-00501	0.5	1	50	4	1	●
US200-S2-00802	0.8	2	50	4	1	●
US200-S2-01003	1	3	50	4	1	●
US200-S2-01504	1.5	4	50	4	1	●
US200-S2-02006	2	6	50	4	1	●
US200-S2-02508	2.5	8	50	4	1	●
US200-S2-63008	3	8	50	6	1	●
US200-S2-03009	3	9	50	4	1	●
US200-S2-03510	3.5	10	50	4	1	●
US200-S2-04011	4	11	50	4	2	●
US200-S2-64011	4	11	50	6	1	●
US200-S2-05013	5	13	50	6	1	●
US200-S2-06016	6	16	50	6	2	●
US200-S2-08020	8	20	60	8	2	●
US200-S2-10025	10	25	75	10	2	●
US200-S2-12030	12	30	75	12	2	●
US200-S2-16036	16	36	100	16	2	●
US200-S2-20045	20	45	100	20	2	○

● Stock ○ Available upon Order

D	Tol
D ≤ 12	0 -0.02
D > 12	0 -0.03

Unit (mm)

Workpiece Material					
P		M	K	S	
1234	5	123	123	123	4
Carbon Steel, Alloy Steel (<35HRC)	Alloy Steel, Tool Steel (<48HRC)	Stainless Steel	Cast Iron	Heat-resistant Alloys	Titanium Alloys
○	○	◎	○	○	○

◎ Most Suitable ○ Suitable

Recommended Cutting Data ※ P559

US200-SS4

4 Flutes, Stub Length, Square

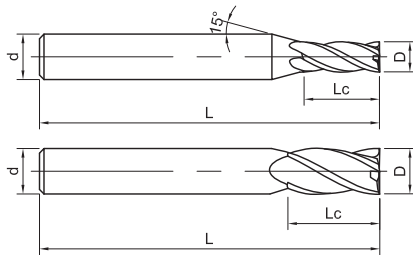

Fig1

Fig2



Please refer to page 167

Ordering Code	D	Lc	L	d	Figure No.	Stock
US200-SS4-02004	2	4	50	4	1	●
US200-SS4-03004	3	4	50	4	1	●
US200-SS4-04006	4	6	50	4	2	●
US200-SS4-06009	6	9	50	6	2	●
US200-SS4-08010	8	10	60	8	2	●
US200-SS4-10012	10	12	75	10	2	●
US200-SS4-12016	12	16	75	12	2	●
US200-SS4-14020	14	20	75	14	2	●
US200-SS4-16024	16	24	100	16	2	●
US200-SS4-18027	18	27	100	18	2	●
US200-SS4-20030	20	30	100	20	2	○

● Stock ○ Available upon Order

D	Tol
D ≤ 12	0 -0.02
D > 12	0 -0.03

Unit (mm)

Workpiece Material					
P		M	K	S	
1234	5	123	123	123	4
Carbon Steel, Alloy Steel (<35HRC)	Alloy Steel, Tool Steel (<48HRC)	Stainless Steel	Cast Iron	Heat-resistant Alloys	Titanium Alloys
○	○	◎	○	○	○

◎ Most Suitable ○ Suitable

Recommended Cutting Data ※ P560

US200-S4

4 Flutes, Standard Length, Square

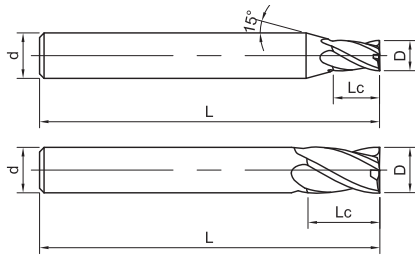

Fig1

Fig2



Please refer to page 167

Ordering Code	D	Lc	L	d	Figure No.	Stock
US200-S4-01003	1	3	50	4	1	●
US200-S4-01504	1.5	4	50	4	1	●
US200-S4-01505	1.5	5	50	4	1	●
US200-S4-02006	2	6	50	4	1	●
US200-S4-02508	2.5	8	50	4	1	●
US200-S4-63008	3	8	50	6	1	●
US200-S4-03009	3	9	50	4	1	●
US200-S4-03510	3.5	10	50	4	1	●
US200-S4-04011	4	11	50	4	2	●
US200-S4-64011	4	11	50	6	1	●
US200-S4-05013	5	13	50	6	1	●
US200-S4-06016	6	16	50	6	2	●
US200-S4-08020	8	20	60	8	2	●
US200-S4-10025	10	25	75	10	2	●
US200-S4-12030	12	30	75	12	2	●
US200-S4-13032	13	32	100	14	1	●
US200-S4-14040	14	40	100	14	2	●
US200-S4-16036	16	36	100	16	2	●
US200-S4-20045	20	45	100	20	2	●
US200-S4-22050	22	50	119	22	2	○

● Stock ○ Available upon Order

D	Tol
D ≤ 12	0 -0.02
D > 12	0 -0.03

Unit (mm)

Workpiece Material					
P		M	K	S	
1234	5	123	123	123	4
Carbon Steel, Alloy Steel (<35HRC)	Alloy Steel, Tool Steel (<48HRC)	Stainless Steel	Cast Iron	Heat-resistant Alloys	Titanium Alloys
○	○	◎	○	○	○

◎ Most Suitable ○ Suitable

Recommended Cutting Data ※ P560

US200-SN4

4 Flutes, with Long Neck, Square

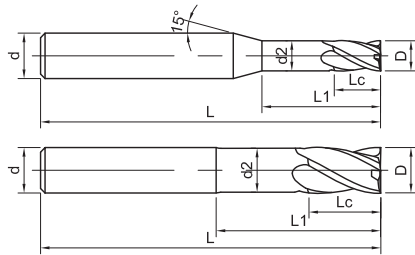

Fig1

Fig2



Please refer to page 167

Ordering Code	D	Lc	d2	L1	L	d	Figure No.	Stock
US200-SN4-02008	2	4	1.95	8	50	4	1	●
US200-SN4-04012	4	8	3.85	12	50	4	2	●
US200-SN4-06018	6	13	5.8	18	50	6	2	●
US200-SN4-08025	8	19	7.5	25	60	8	2	●
US200-SN4-10032	10	22	9.5	32	75	10	2	●
US200-SN4-12034	12	24	11	34	75	12	2	●
US200-SN4-16036	16	26	15	36	100	16	2	○
US200-SN4-20040	20	28	19	40	100	20	2	○

● Stock ○ Available upon Order

D	Tol
D ≤ 12	0 -0.02
D > 12	0 -0.03

Unit (mm)

Workpiece Material					
P		M	K	S	
1234	5	123	123	123	4
Carbon Steel, Alloy Steel (<35HRC)	Alloy Steel, Tool Steel (<48HRC)	Stainless Steel	Cast Iron	Heat-resistant Alloys	Titanium Alloys
○	○	◎	○	○	○

◎ Most Suitable ○ Suitable

Recommended Cutting Data ※ P560

US200-R2

2 Flutes, Corner Radius

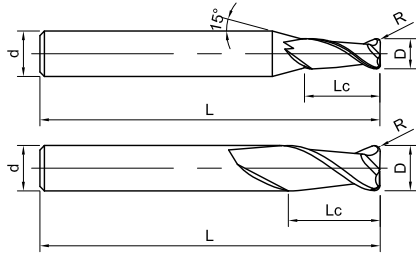

Fig1

Fig2



Please refer to page 167

Ordering Code	D	Lc	R	L	d	Figure No.	Stock
US200-R2-03003	3	9	0.3	50	4	1	●
US200-R2-03005	3	9	0.5	50	4	1	○
US200-R2-04002	4	11	0.2	50	4	2	●
US200-R2-04003	4	11	0.3	50	4	2	●
US200-R2-64005	4	11	0.5	50	6	1	●
US200-R2-05003	5	13	0.3	50	6	1	●
US200-R2-05005	5	13	0.5	50	6	1	●
US200-R2-06002	6	16	0.2	50	6	2	●
US200-R2-06003	6	16	0.3	50	6	2	●
US200-R2-08005	8	20	0.5	60	8	2	●
US200-R2-10005	10	25	0.5	75	10	2	●
US200-R2-10010	10	25	1	75	10	2	●
US200-R2-10015	10	25	1.5	75	10	2	●
US200-R2-16005	16	36	0.5	100	16	2	●

● Stock ○ Available upon Order

D	Tol
D ≤ 12	0 -0.02
D > 12	0 -0.03

Unit (mm)

Workpiece Material					
P		M	K	S	
1234	5	123	123	123	4
Carbon Steel, Alloy Steel (<35HRC)	Alloy Steel, Tool Steel (<48HRC)	Stainless Steel	Cast Iron	Heat-resistant Alloys	Titanium Alloys
○	○	◎	○	○	○

◎ Most Suitable ○ Suitable

Recommended Cutting Data ※ P559

US200-R3

3 Flutes, Corner Radius

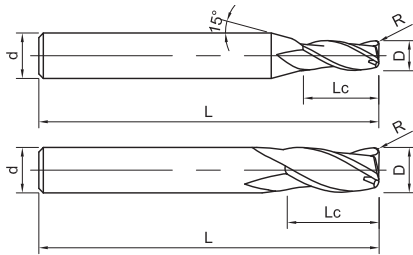
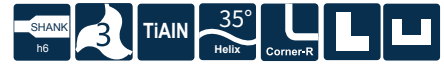

Fig1

Fig2



Please refer to page 167

Ordering Code	D	Lc	R	L	d	Figure No.	Stock
US200-R3-02002	2	6	0.2	50	4	1	●
US200-R3-04002	4	11	0.2	50	4	2	●
US200-R3-04005	4	11	0.5	50	4	2	●
US200-R3-06002	6	16	0.2	50	6	2	●
US200-R3-06005	6	16	0.5	50	6	2	●
US200-R3-08005	8	20	0.5	60	8	2	●
US200-R3-08010	8	20	1	60	8	2	●
US200-R3-10010	10	25	1	75	10	2	●
US200-R3-10020	10	25	2	75	10	2	○
US200-R3-12005	12	30	0.5	75	12	2	●
US200-R3-12010	12	30	1	75	12	2	●
US200-R3-12015	12	30	1.5	75	12	2	○
US200-R3-16005	16	36	0.5	100	16	2	●
US200-R3-16010	16	36	1	100	16	2	○
US200-R3-16020	16	36	2	100	16	2	○
US200-R3-20005	20	45	0.5	100	20	2	●
US200-R3-20040	20	45	4	100	20	2	●

● Stock ○ Available upon Order

D	Tol
D ≤ 12	0 -0.02
D > 12	0 -0.03

Unit (mm)

Workpiece Material					
P		M	K	S	
1234	5	123	123	123	4
Carbon Steel, Alloy Steel (<35HRC)	Alloy Steel, Tool Steel (<48HRC)	Stainless Steel	Cast Iron	Heat-resistant Alloys	Titanium Alloys
○	○	◎	○	○	○

◎ Most Suitable ○ Suitable

Recommended Cutting Data ※ P559

US200-R4

4 Flutes, Corner Radius

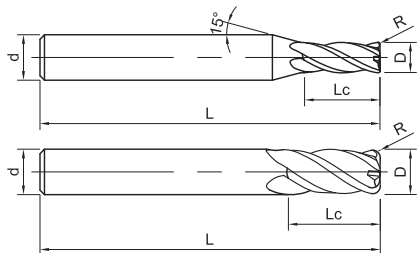

Fig1

Fig2



Please refer to page 167

Ordering Code	D	Lc	R	L	d	Figure No.	Stock
US200-R4-02002	2	6	0.2	50	4	1	●
US200-R4-03003	3	9	0.3	50	4	1	●
US200-R4-03005	3	9	0.5	50	4	1	●
US200-R4-64002	4	11	0.2	50	6	1	●
US200-R4-64003	4	11	0.3	50	6	1	●
US200-R4-04003	4	11	0.3	50	4	2	●
US200-R4-04005	4	11	0.5	50	4	2	●
US200-R4-05005	5	13	0.5	50	6	1	●
US200-R4-06005	6	16	0.5	50	6	2	●
US200-R4-08002	8	20	0.2	60	8	2	●
US200-R4-08005	8	20	0.5	60	8	2	●
US200-R4-08010	8	20	1	60	8	2	●
US200-R4-10005	10	25	0.5	75	10	2	●
US200-R4-10010	10	25	1	75	10	2	●
US200-R4-12005	12	30	0.5	75	12	2	●
US200-R4-12010	12	30	1	75	12	2	●
US200-R4-12020	12	30	2	75	12	2	●
US200-R4-16010	16	36	1	100	16	2	●
US200-R4-20010	20	45	1	100	20	2	○

● Stock ○ Available upon Order

D	Tol
D ≤ 12	0 -0.02
D > 12	0 -0.03

Unit (mm)

Workpiece Material					
P		M	K	S	
1234	5	123	123	123	4
Carbon Steel, Alloy Steel (<35HRC)	Alloy Steel, Tool Steel (<48HRC)	Stainless Steel	Cast Iron	Heat-resistant Alloys	Titanium Alloys
○	○	◎	○	○	○

◎ Most Suitable ○ Suitable

Recommended Cutting Data ※ P560

US200-B2

2 Flutes, Ballnose

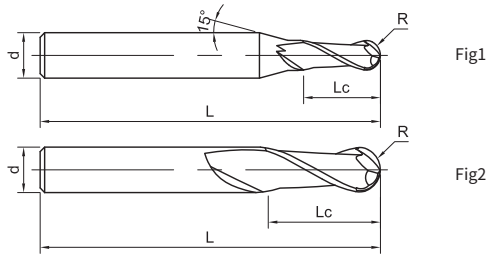

Please refer to page 167

Ordering Code	D	Lc	R	L	d	Figure No.	Stock
US200-B2-01002	1	2	0.5	50	4	1	●
US200-B2-01503	1.5	3	0.75	50	4	1	●
US200-B2-02004	2	4	1	50	4	1	●
US200-B2-03006	3	6	1.5	50	4	1	●
US200-B2-63006	3	6	1.5	50	6	1	●
US200-B2-04008	4	8	2	50	4	2	●
US200-B2-64008	4	8	2	50	6	1	●
US200-B2-05010	5	10	2.5	50	6	1	●
US200-B2-06012	6	12	3	50	6	2	●
US200-B2-08014	8	14	4	60	8	2	●
US200-B2-10018	10	18	5	75	10	2	●
US200-B2-12022	12	22	6	75	12	2	●
US200-B2-16026	16	26	8	100	16	2	○

● Stock ○ Available upon Order

R	Tol
R < 3	±0.015
R ≥ 3	±0.02

Unit (mm)

Workpiece Material					
P		M	K	S	
1234	5	123	123	123	4
Carbon Steel, Alloy Steel (<35HRC)	Alloy Steel, Tool Steel (<48HRC)	Stainless Steel	Cast Iron	Heat-resistant Alloys	Titanium Alloys
○	○	◎	○	○	○

◎ Most Suitable ○ Suitable

Recommended Cutting Data ※ P560

US200-B4

4 Flutes, Ballnose

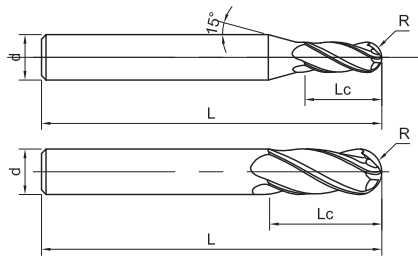

Fig1

Fig2



Please refer to page 167

Ordering Code	D	Lc	R	L	d	Figure No.	Stock
US200-B4-01002	1	2	0.5	50	4	1	●
US200-B4-01503	1.5	3	0.75	50	4	1	●
US200-B4-02004	2	4	1	50	4	1	●
US200-B4-03006	3	6	1.5	50	4	1	●
US200-B4-63006	3	6	1.5	50	6	1	●
US200-B4-04008	4	8	2	50	4	2	●
US200-B4-05010	5	10	2.5	50	6	1	●
US200-B4-06012	6	12	3	50	6	2	●
US200-B4-08014	8	14	4	60	8	2	●
US200-B4-10018	10	18	5	75	10	2	●
US200-B4-12022	12	22	6	75	12	2	●
US200-B4-16026	16	26	8	100	16	2	●
US200-B4-20038	20	38	10	100	20	2	○

● Stock ○ Available upon Order

R	Tol
R < 3	±0.015
R ≥ 3	±0.02

Unit (mm)

Workpiece Material					
P		M	K	S	
1234	5	123	123	123	4
Carbon Steel, Alloy Steel (<35HRC)	Alloy Steel, Tool Steel (<48HRC)	Stainless Steel	Cast Iron	Heat-resistant Alloys	Titanium Alloys
○	○	◎	○	○	○

◎ Most Suitable ○ Suitable

Recommended Cutting Data ※ P560

US260-S2/SS2

2 Flutes, Standard Length / Stub Length, Square

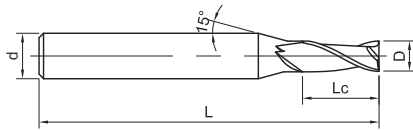
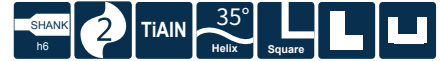

Fig1



Please refer to page 167

Ordering Code	D	Lc	L	d	Figure No.	Stock
US260-S2-00501	0.5	1	50	4	1	●
US260-S2-00802	0.8	2	50	4	1	●
US260-S2-00801	0.8	1	50	4	1	●

● Stock ○ Available upon Order

D	Tol
D ≤ 12	0 -0.02

Unit (mm)

Workpiece Material					
P		M	K	S	
1234	5	123	123	123	4
Carbon Steel, Alloy Steel (<35HRC)	Alloy Steel, Tool Steel (<48HRC)	Stainless Steel	Cast Iron	Heat-resistant Alloys	Titanium Alloys
○	○	◎	○	○	○

◎ Most Suitable ○ Suitable

Recommended Cutting Data ※ P561

US260-SS4A

4 Flutes, Stub Length, Square

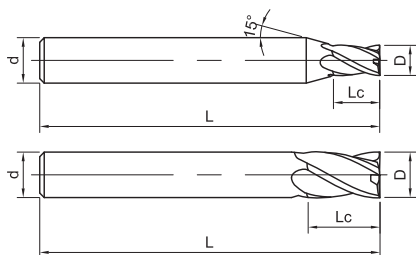

Fig1

Fig2



Please refer to page 167

Ordering Code	D	Lc	L	d	Figure No.	Stock
US260-SS4A-01002	1	2	50	4	1	●
US260-SS4A-01502	1.5	2.5	50	4	1	●
US260-SS4A-01503	1.5	3	50	4	1	●
US260-SS4A-02004	2	4	50	4	1	●
US260-SS4A-03003	3	3	50	4	1	●
US260-SS4A-03006	3	6	50	4	1	●
US260-SS4A-04006	4	6	50	4	2	●
US260-SS4A-06006	6	6	50	6	2	●
US260-SS4A-06010	6	10	50	6	2	●
US260-SS4A-08015	8	15	60	8	2	●
US260-SS4A-10015	10	15	50	10	2	●
US260-SS4A-12015	12	15	50	12	2	●
US260-SS4A-16024	16	24	100	16	2	○
US260-SS4A-20030	20	30	100	20	2	○

● Stock ○ Available upon Order

D	Tol
D ≤ 12	0 -0.02
D > 12	0 -0.03

Unit (mm)

Workpiece Material					
P		M	K	S	
1234	5	123	123	123	4
Carbon Steel, Alloy Steel (<35HRC)	Alloy Steel, Tool Steel (<48HRC)	Stainless Steel	Cast Iron	Heat-resistant Alloys	Titanium Alloys
○	○	◎	○	○	○

◎ Most Suitable ○ Suitable

Recommended Cutting Data ※ P561

US260-SS4B

4 Flutes, Square, Stub Length, for Finishing

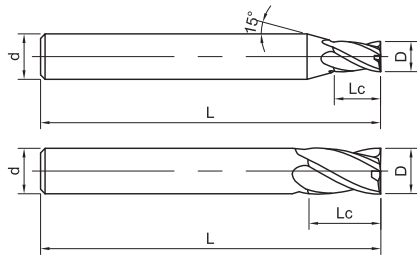

Fig1

Fig2



Please refer to page 167

Ordering Code	D	Lc	L	d	Figure No.	Stock
US260-SS4B-01002	1	2	50	4	1	●
US260-SS4B-01503	1.5	3	50	4	1	●
US260-SS4B-02004	2	4	50	4	1	●
US260-SS4B-03003	3	3	50	4	1	●
US260-SS4B-04006	4	6	50	4	2	●
US260-SS4B-05006	5	6	50	6	1	●
US260-SS4B-06006	6	6	50	6	2	●

● Stock ○ Available upon Order

D	Tol
D ≤ 12	0 -0.02

Unit (mm)

Workpiece Material					
P		M	K	S	
1234	5	123	123	123	4
Carbon Steel, Alloy Steel (<35HRC)	Alloy Steel, Tool Steel (<48HRC)	Stainless Steel	Cast Iron	Heat-resistant Alloys	Titanium Alloys
○	○	◎	○	○	○

◎ Most Suitable ○ Suitable

Recommended Cutting Data ※ P561

US260-S4A

4 Flutes, Square, Standard Length

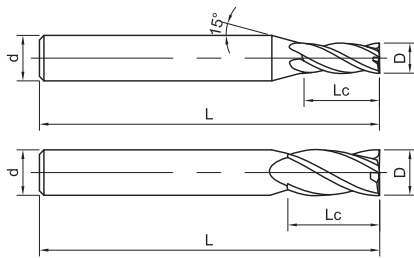

Fig1

Fig2



Please refer to page 167

Ordering Code	D	Lc	L	d	Figure No.	Stock
US260-S4A-01003	1	3	50	4	1	●
US260-S4A-01504	1.5	4	50	4	1	●
US260-S4A-01505	1.5	5	50	4	1	●
US260-S4A-01506	1.5	6	50	4	1	●
US260-S4A-02006	2	6	50	4	1	●
US260-S4A-02508	2.5	8	50	4	1	●
US260-S4A-03009	3	9	50	4	1	●
US260-S4A-04011	4	11	50	4	2	●
US260-S4A-05013	5	13	50	6	1	●
US260-S4A-06016	6	16	50	6	2	●
US260-S4A-08020	8	20	60	8	2	●
US260-S4A-10025	10	25	75	10	2	●
US260-S4A-10030	10	30	75	10	2	●
US260-S4A-12030	12	30	75	12	2	●
US260-S4A-16036	16	36	100	16	2	●
US260-S4A-20045	20	45	100	20	2	○

● Stock ○ Available upon Order

D	Tol
D ≤ 12	0 -0.02
D > 12	0 -0.03

Unit (mm)

Workpiece Material					
P		M	K	S	
1234	5	123	123	123	4
Carbon Steel, Alloy Steel (<35HRC)	Alloy Steel, Tool Steel (<48HRC)	Stainless Steel	Cast Iron	Heat-resistant Alloys	Titanium Alloys
○	○	◎	○	○	○

◎ Most Suitable ○ Suitable

Recommended Cutting Data ※ P561

US260-S4B

4 Flutes, Square, Standard Length, for Finishing

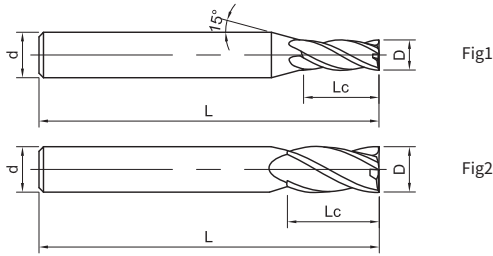

Please refer to page 167

Ordering Code	D	Lc	L	d	Figure No.	Stock
US260-S4B-01003	1	3	50	4	1	●
US260-S4B-01203	1.2	3	50	4	1	●
US260-S4B-01503	1.5	3.5	50	4	1	●
US260-S4B-01504	1.5	4	50	4	1	●
US260-S4B-02006	2	6	50	4	1	●
US260-S4B-03009	3	9	50	4	1	●
US260-S4B-04011	4	11	50	4	2	●
US260-S4B-06016	6	16	50	6	2	●

● Stock ○ Available upon Order

D	Tol
D ≤ 12	0 -0.02

Unit (mm)

Workpiece Material					
P		M	K	S	
1234	5	123	123	123	4
Carbon Steel, Alloy Steel (<35HRC)	Alloy Steel, Tool Steel (<48HRC)	Stainless Steel	Cast Iron	Heat-resistant Alloys	Titanium Alloys
○	○	◎	○	○	○

◎ Most Suitable ○ Suitable

Recommended Cutting Data ※ P561

US260-RS4

4 Flutes, Corner Radius, Stub Length

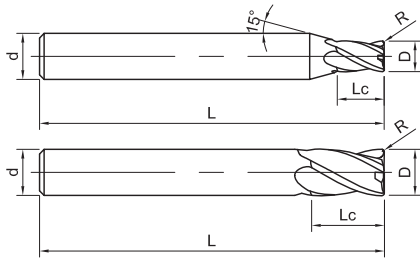

Fig1

Fig2



Please refer to page 167

Ordering Code	D	Lc	R	L	d	Figure No.	Stock
US260-RS4-01001	1	2	0.1	50	4	1	●
US260-RS4-04001	4	5	0.1	50	4	2	●
US260-RS4-04002	4	5	0.2	50	4	2	●
US260-RS4-05001	5	6	0.1	50	6	1	●
US260-RS4-06001	6	8	0.1	50	6	2	●
US260-RS4-06002	6	8	0.2	50	6	2	●
US260-RS4-06005	6	8	0.5	50	6	2	●
US260-RS4-08002	8	15	0.2	60	8	2	●
US260-RS4-08005	8	15	0.5	60	8	2	●
US260-RS4-10002	10	15	0.2	50	10	2	●
US260-RS4-10005	10	15	0.5	50	10	2	●
US260-RS4-12010	12	15	1	75	12	2	●
US260-RS4-16010	16	24	1	100	16	2	○
US260-RS4-20010	20	30	1	100	20	2	○

● Stock ○ Available upon Order

D	Tol
D ≤ 12	0 -0.02
D > 12	0 -0.03

Unit (mm)

Workpiece Material					
P		M	K	S	
1234	5	123	123	123	4
Carbon Steel, Alloy Steel (<35HRC)	Alloy Steel, Tool Steel (<48HRC)	Stainless Steel	Cast Iron	Heat-resistant Alloys	Titanium Alloys
○	○	◎	○	○	○

◎ Most Suitable ○ Suitable

Recommended Cutting Data ※ P562

US260-R4

4 Flutes, Corner Radius, Standard Length

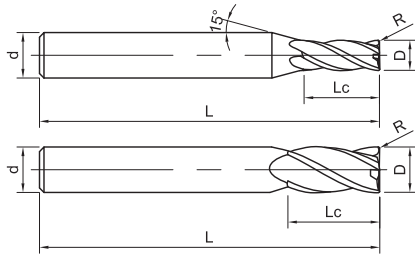

Fig1

Fig2



Please refer to page 167

Ordering Code	D	Lc	R	L	d	Figure No.	Stock
US260-R4-01501	1.5	5	0.1	50	4	1	●
US260-R4-02001	2	6	0.1	50	4	1	●
US260-R4-02002	2	6	0.2	50	4	1	●
US260-R4-03001	3	9	0.1	50	4	1	●
US260-R4-63001	3	9	0.1	50	6	1	●
US260-R4-03002	3	9	0.2	50	4	1	●
US260-R4-63002	3	9	0.2	50	6	1	●
US260-R4-03003	3	9	0.3	50	4	1	●
US260-R4-63003	3	9	0.3	50	6	1	●
US260-R4-04001	4	11	0.1	50	4	2	●
US260-R4-04002	4	11	0.2	50	4	2	●
US260-R4-04010	4	11	1	50	4	2	○
US260-R4-06001	6	16	0.1	50	6	2	●
US260-R4-06002	6	12	0.2	50	6	2	●
US260-R4-06005	6	16	0.5	50	6	2	●

● Stock ○ Available upon Order

D	Tol
D ≤ 12	0 -0.02
D > 12	0 -0.03

Unit (mm)

Workpiece Material					
P		M	K	S	
1234	5	123	123	123	4
Carbon Steel, Alloy Steel (<35HRC)	Alloy Steel, Tool Steel (<48HRC)	Stainless Steel	Cast Iron	Heat-resistant Alloys	Titanium Alloys
○	○	◎	○	○	○

◎ Most Suitable ○ Suitable

Recommended Cutting Data ※ P562

US260-R4

4 Flutes, Corner Radius, Standard Length

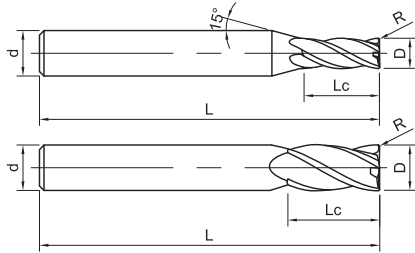

Fig1

Fig2



Please refer to page 167

» Continuation

Ordering Code	D	Lc	R	L	d	Figure No.	Stock
US260-R4-06010	6	16	1	50	6	2	○
US260-R4-08005	8	20	0.5	60	8	2	●
US260-R4-08010	8	20	1	60	8	2	●
US260-R4-10005	10	25	0.5	75	10	2	●
US260-R4-10010	10	25	1	75	10	2	●
US260-R4-12005	12	30	0.5	75	12	2	●
US260-R4-12010	12	30	1	75	12	2	●
US260-R4-12020	12	30	2	75	12	2	●
US260-R4-12030	12	30	3	75	12	2	○
US260-R4-16010	16	36	1	100	16	2	○
US260-R4-16020	16	36	2	100	16	2	○
US260-R4-16030	16	36	3	100	16	2	○
US260-R4-20010	20	45	1	100	20	2	○
US260-R4-20020	20	45	2	100	20	2	○
US260-R4-20030	20	45	3	100	20	2	○

● Stock ○ Available upon Order

D	Tol
D ≤ 12	0 -0.02
D > 12	0 -0.03

Unit (mm)

Workpiece Material					
P		M	K	S	
1234	5	123	123	123	4
Carbon Steel, Alloy Steel (<35HRC)	Alloy Steel, Tool Steel (<48HRC)	Stainless Steel	Cast Iron	Heat-resistant Alloys	Titanium Alloys
○	○	◎	○	○	○

◎ Most Suitable ○ Suitable

Recommended Cutting Data ※ P562

SS600-SS4

4 Flutes, Stub Length, Square

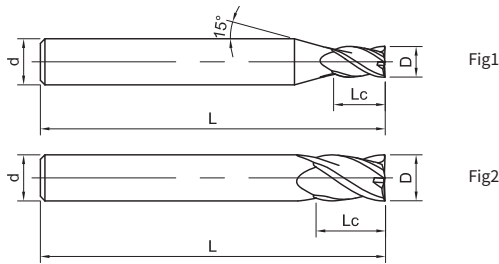

Please refer to page 167

Ordering Code	D	Lc	L	d	Figure No.	Stock
SS600-SS4-02003	2	3	38	3	1	○
SS600-SS4-02004	2	4	50	4	1	●
SS600-SS4-03006	3	6	50	4	1	●
SS600-SS4-04006	4	6	50	4	2	●
SS600-SS4-06006	6	6	50	6	2	●
SS600-SS4-06010	6	10	50	6	2	●
SS600-SS4-08015	8	15	60	8	2	●
SS600-SS4-10015	10	15	60	10	2	○
SS600-SS4-12016	12	16	75	12	2	●
SS600-SS4-16022	16	22	92	16	2	●
SS600-SS4-20026	20	26	100	20	2	○

● Stock ○ Available upon Order

D	Tol
D < 6	0 -0.02
6 ≤ D ≤ 12	0 -0.03
D > 12	0 -0.04

Unit (mm)

Workpiece Material					
P		M	K	S	
1234	5	123	123	123	4
Carbon Steel, Alloy Steel (<35HRC)	Alloy Steel, Tool Steel (<48HRC)	Stainless Steel	Cast Iron	Heat-resistant Alloys	Titanium Alloys
○	○	○	○	○	○

○ Most Suitable ○ Suitable

Recommended Cutting Data ※ P563

SS600-S4

4 Flutes, Standard Length, Square

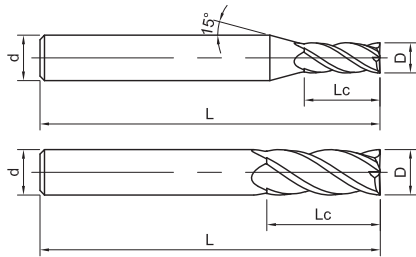

Fig1

Fig2



Please refer to page 167

Ordering Code	D	Lc	L	d	Figure No.	Stock
SS600-S4-01003	1	3	38	3	1	○
SS600-S4-01506	1.5	6	38	3	1	○
SS600-S4-02006	2	6	50	4	1	●
SS600-S4-02506	2.5	6	50	4	1	○
SS600-S4-03009	3	9	50	4	1	●
SS600-S4-63009	3	9	50	6	1	○
SS600-S4-04011	4	11	50	4	2	●
SS600-S4-64011	4	11	50	6	1	●
SS600-S4-04014	4	14	50	4	2	○
SS600-S4-05013	5	13	50	6	1	●
SS600-S4-06016	6	16	50	6	2	●
SS600-S4-08020	8	20	60	8	2	●
SS600-S4-10025	10	25	75	10	2	●
SS600-S4-12026	12	26	83	12	2	●
SS600-S4-14026	14	26	83	14	2	○
SS600-S4-16032	16	32	92	16	2	●
SS600-S4-20038	20	38	100	20	2	●

● Stock ○ Available upon Order

D	Tol
D < 6	0 -0.02
6 ≤ D ≤ 12	0 -0.03
D > 12	0 -0.04

Unit (mm)

Workpiece Material					
P		M	K	S	
1234	5	123	123	123	4
Carbon Steel, Alloy Steel (<35HRC)	Alloy Steel, Tool Steel (<48HRC)	Stainless Steel	Cast Iron	Heat-resistant Alloys	Titanium Alloys
○	○	○	○	○	○

○ Most Suitable ○ Suitable

Recommended Cutting Data ※ P563

SS600-SH4

4 Flutes, Long Shank Length, Square

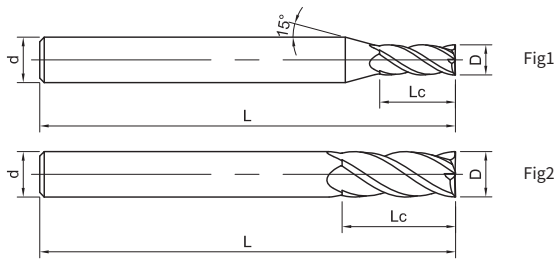

Please refer to page 167

Ordering Code	D	Lc	L	d	Figure No.	Stock
SS600-SH4-62007	2	7	60	6	1	○
SS600-SH4-63008	3	8	60	6	1	○
SS600-SH4-04011	4	11	75	4	2	○
SS600-SH4-05013	5	13	75	6	1	○
SS600-SH4-05016	5	16	60	6	1	○
SS600-SH4-06016	6	16	75	6	2	○
SS600-SH4-08020	8	20	75	8	2	○
SS600-SH4-08020A	8	20	100	8	2	○
SS600-SH4-10025	10	25	100	10	2	○
SS600-SH4-12026	12	26	100	12	2	○
SS600-SH4-12040	12	40	150	12	2	○
SS600-SH4-16050	16	50	120	16	2	○
SS600-SH4-16050A	16	50	150	16	2	○
SS600-SH4-20050	20	50	150	20	2	○

● Stock ○ Available upon Order

D	Tol
D < 6	0 -0.02
6 ≤ D ≤ 12	0 -0.03
D > 12	0 -0.04

Unit (mm)

Workpiece Material					
P		M	K	S	
1234	5	123	123	123	4
Carbon Steel, Alloy Steel (<35HRC)	Alloy Steel, Tool Steel (<48HRC)	Stainless Steel	Cast Iron	Heat-resistant Alloys	Titanium Alloys
○	○	○	○	○	○

○ Most Suitable ○ Suitable

Recommended Cutting Data ※ P563

SS600-S5

5 Flutes, Standard Length, Square

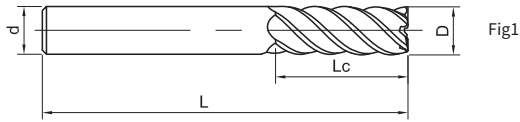

Fig1



Please refer to page 167

Ordering Code	D	Lc	L	d	Figure No.	Stock
SS600-S5-06016	6	16	50	6	1	●
SS600-S5-06016A	6	16	75	6	1	○
SS600-S5-08020	8	20	60	8	1	●
SS600-S5-08020A	8	20	75	8	1	○
SS600-S5-10025	10	25	75	10	1	●
SS600-S5-10025A	10	25	100	10	1	○
SS600-S5-12026	12	26	83	12	1	●
SS600-S5-12026A	12	26	100	12	1	○
SS600-S5-16032	16	32	92	16	1	○
SS600-S5-16050	16	50	150	16	1	○
SS600-S5-20038	20	38	100	20	1	○
SS600-S5-20050	20	50	150	20	1	○
SS600-S5-25050	25	50	125	25	1	○
SS600-S5-25050A	25	50	150	25	1	○

● Stock ○ Available upon Order

D	Tol
D < 6	0 -0.02
6 ≤ D ≤ 12	0 -0.03
D > 12	0 -0.04

Unit (mm)

Workpiece Material					
P		M	K	S	
1234	5	123	123	123	4
Carbon Steel, Alloy Steel (<35HRC)	Alloy Steel, Tool Steel (<48HRC)	Stainless Steel	Cast Iron	Heat-resistant Alloys	Titanium Alloys
○	○	○	○	○	○

○ Most Suitable ○ Suitable

Recommended Cutting Data ※ P563

SS600-RS4

4 Flutes, Corner Radius, Stub Length

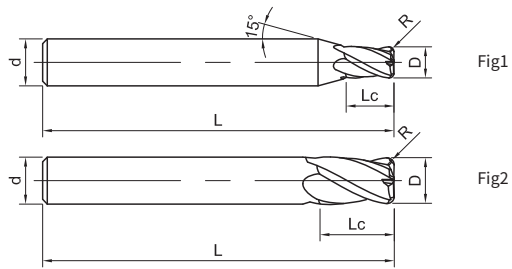

Please refer to page 167

Ordering Code	D	R	Lc	L	d	Figure No.	Stock
SS600-RS4-02001	2	0.1	4	50	4	1	●
SS600-RS4-04002	4	0.2	6	50	4	2	●
SS600-RS4-06005	6	0.5	10	50	6	2	●
SS600-RS4-08005	8	0.5	12	60	8	2	●
SS600-RS4-10005	10	0.5	14	60	10	2	●
SS600-RS4-12010	12	1	16	75	12	2	●
SS600-RS4-16010	16	1	22	92	16	2	○
SS600-RS4-20010	20	1	26	100	20	2	○

● Stock ○ Available upon Order

D	Tol
D < 6	0 -0.02
6 ≤ D ≤ 12	0 -0.03
D > 12	0 -0.04

Unit (mm)

Workpiece Material					
P		M	K	S	
1234	5	123	123	123	4
Carbon Steel, Alloy Steel (<35HRC)	Alloy Steel, Tool Steel (<48HRC)	Stainless Steel	Cast Iron	Heat-resistant Alloys	Titanium Alloys
○	○	○	○	○	○

○ Most Suitable ○ Suitable

Recommended Cutting Data ※ P563

SS600-R4

4 Flutes, Corner Radius

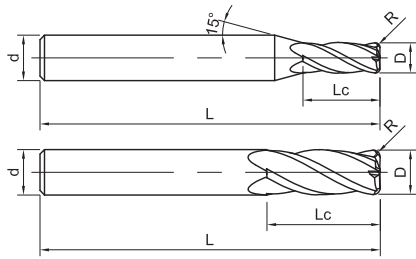

Fig1

Fig2



Please refer to page 167

Ordering Code	D	R	Lc	L	d	Figure No.	Stock
SS600-R4-02002	2	0.2	6	50	4	1	●
SS600-R4-03005	3	0.5	8	50	4	1	●
SS600-R4-04005	4	0.5	11	50	4	2	●
SS600-R4-64005	4	0.5	11	50	6	1	●
SS600-R4-05005	5	0.5	13	50	6	1	●
SS600-R4-06005	6	0.5	16	50	6	2	●
SS600-R4-06010	6	1	16	50	6	2	●
SS600-R4-06020	6	2	16	50	6	2	○
SS600-R4-08005	8	0.5	20	60	8	2	●
SS600-R4-08010	8	1	20	60	8	2	●
SS600-R4-08020	8	2	20	60	8	2	○
SS600-R4-08030	8	3	20	60	8	2	○
SS600-R4-10005	10	0.5	25	75	10	2	●
SS600-R4-10010	10	1	25	75	10	2	●
SS600-R4-10020	10	2	25	75	10	2	●
SS600-R4-10030	10	3	25	75	10	2	○
SS600-R4-12005	12	0.5	26	83	12	2	●

● Stock ○ Available upon Order

D	Tol
D < 6	0 -0.02
6 ≤ D ≤ 12	0 -0.03
D > 12	0 -0.04

Unit (mm)

Workpiece Material					
P		M	K	S	
1234	5	123	123	123	4
Carbon Steel, Alloy Steel (<35HRC)	Alloy Steel, Tool Steel (<48HRC)	Stainless Steel	Cast Iron	Heat-resistant Alloys	Titanium Alloys
○	○	○	○	○	○

○ Most Suitable ○ Suitable

Recommended Cutting Data ※ P563

SS600-R4

4 Flutes, Corner Radius

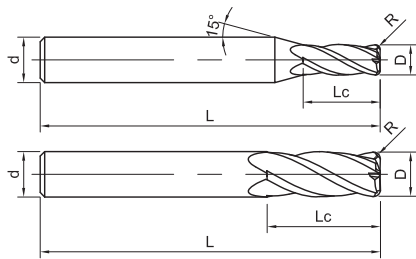

Fig1

Fig2



Please refer to page 167

» Continuation

Ordering Code	D	R	Lc	L	d	Figure No.	Stock
SS600-R4-12010	12	1	26	83	12	2	●
SS600-R4-12020	12	2	26	83	12	2	●
SS600-R4-12030	12	3	26	83	12	2	●
SS600-R4-16005	16	0.5	32	92	16	2	○
SS600-R4-16010	16	1	32	92	16	2	●
SS600-R4-16015	16	1.5	32	92	16	2	○
SS600-R4-16020	16	2	32	92	16	2	●
SS600-R4-16030	16	3	32	92	16	2	○
SS600-R4-16040	16	4	32	92	16	2	○
SS600-R4-16050	16	5	32	92	16	2	○
SS600-R4-20005	20	0.5	38	100	20	2	○
SS600-R4-20010	20	1	38	100	20	2	●
SS600-R4-20020	20	2	38	100	20	2	●
SS600-R4-20030	20	3	38	100	20	2	○
SS600-R4-20040	20	4	38	100	20	2	○
SS600-R4-20050	20	5	38	100	20	2	○

● Stock ○ Available upon Order

D	Tol
D < 6	0 -0.02
6 ≤ D ≤ 12	0 -0.03
D > 12	0 -0.04

Unit (mm)

Workpiece Material					
P		M	K	S	
1234	5	123	123	123	4
Carbon Steel, Alloy Steel (<35HRC)	Alloy Steel, Tool Steel (<48HRC)	Stainless Steel	Cast Iron	Heat-resistant Alloys	Titanium Alloys
○	○	○	○	○	○

○ Most Suitable ○ Suitable

Recommended Cutting Data ※ P563

SS600-RH4

4 Flutes, Corner Radius, Long Shank

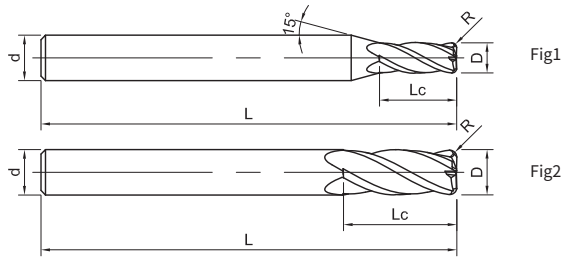

Please refer to page 167

Ordering Code	D	R	Lc	L	d	Figure No.	Stock
SS600-RH4-64005	4	0.5	11	75	6	1	○
SS600-RH4-05010	5	1	13	60	6	1	○
SS600-RH4-06005	6	0.5	16	75	6	2	○
SS600-RH4-06010	6	1	16	75	6	2	○
SS600-RH4-06020	6	2	16	75	6	2	○
SS600-RH4-08005	8	0.5	20	75	8	2	○
SS600-RH4-08010	8	1	20	75	8	2	○
SS600-RH4-08020	8	2	20	75	8	2	○
SS600-RH4-08030	8	3	20	75	8	2	○
SS600-RH4-10005	10	0.5	25	100	10	2	○
SS600-RH4-10010	10	1	25	100	10	2	○
SS600-RH4-10020	10	2	25	100	10	2	○
SS600-RH4-10030	10	3	25	100	10	2	○
SS600-RH4-12005	12	0.5	26	100	12	2	○
SS600-RH4-12005A	12	0.5	40	150	12	2	○
SS600-RH4-12010	12	1	26	100	12	2	○
SS600-RH4-12010A	12	1	40	150	12	2	○

● Stock ○ Available upon Order

D	Tol
D < 6	0 -0.02
6 ≤ D ≤ 12	0 -0.03
D > 12	0 -0.04

Unit (mm)

Workpiece Material					
P		M	K	S	
1234	5	123	123	123	4
Carbon Steel, Alloy Steel (<35HRC)	Alloy Steel, Tool Steel (<48HRC)	Stainless Steel	Cast Iron	Heat-resistant Alloys	Titanium Alloys
○	○	○	○	○	○

○ Most Suitable ○ Suitable

Recommended Cutting Data ※ P563

SS600-RH4

4 Flutes, Corner Radius, Long Shank

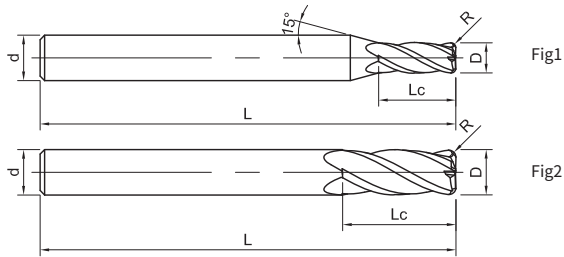

Please refer to page 167

» Continuation

Ordering Code	D	R	Lc	L	d	Figure No.	Stock
SS600-RH4-12020	12	2	26	100	12	2	○
SS600-RH4-12020A	12	2	40	150	12	2	○
SS600-RH4-12030	12	3	26	100	12	2	○
SS600-RH4-12030A	12	3	40	150	12	2	○
SS600-RH4-16005	16	0.5	50	150	16	2	○
SS600-RH4-16010	16	1	50	150	16	2	○
SS600-RH4-16015	16	1.5	50	150	16	2	○
SS600-RH4-16020	16	2	50	150	16	2	○
SS600-RH4-16030	16	3	50	150	16	2	○
SS600-RH4-16040	16	4	50	150	16	2	○
SS600-RH4-16050	16	5	50	150	16	2	○
SS600-RH4-20005	20	0.5	38	150	20	2	○
SS600-RH4-20010	20	1	50	150	20	2	○
SS600-RH4-20020	20	2	50	150	20	2	○
SS600-RH4-20030	20	3	50	150	20	2	○
SS600-RH4-20040	20	4	50	150	20	2	○
SS600-RH4-20050	20	5	50	150	20	2	○

● Stock ○ Available upon Order

D	Tol
D < 6	0 -0.02
6 ≤ D ≤ 12	0 -0.03
D > 12	0 -0.04

Unit (mm)

Workpiece Material					
P		M	K	S	
1234	5	123	123	123	4
Carbon Steel, Alloy Steel (<35HRC)	Alloy Steel, Tool Steel (<48HRC)	Stainless Steel	Cast Iron	Heat-resistant Alloys	Titanium Alloys
○	○	○	○	○	○

○ Most Suitable ○ Suitable

Recommended Cutting Data ※ P563

SS600-R5

5 Flutes, Corner Radius

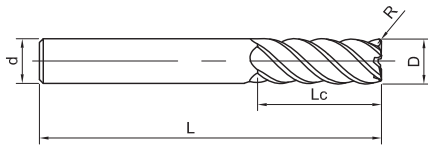

Fig1



Please refer to page 167

Ordering Code	D	R	Lc	L	d	Figure No.	Stock
SS600-R5-06005	6	0.5	16	50	6	1	●
SS600-R5-06005A	6	0.5	16	60	6	1	●
SS600-R5-06005B	6	0.5	16	75	6	1	●
SS600-R5-06010	6	1	16	50	6	1	●
SS600-R5-06010A	6	1	16	75	6	1	○
SS600-R5-06020	6	2	16	50	6	1	○
SS600-R5-06020A	6	2	16	75	6	1	○
SS600-R5-08005	8	0.5	20	60	8	1	●
SS600-R5-08005A	8	0.5	20	75	8	1	●
SS600-R5-08010	8	1	20	60	8	1	●
SS600-R5-08010A	8	1	20	75	8	1	●
SS600-R5-08020	8	2	20	60	8	1	○
SS600-R5-08020A	8	2	20	75	8	1	○
SS600-R5-08030	8	3	20	60	8	1	○
SS600-R5-08030A	8	3	20	75	8	1	○
SS600-R5-10005	10	0.5	25	75	10	1	●

● Stock ○ Available upon Order

D	Tol
D < 6	0 -0.02
6 ≤ D ≤ 12	0 -0.03
D > 12	0 -0.04

Unit (mm)

Workpiece Material					
P		M	K	S	
1234	5	123	123	123	4
Carbon Steel, Alloy Steel (<35HRC)	Alloy Steel, Tool Steel (<48HRC)	Stainless Steel	Cast Iron	Heat-resistant Alloys	Titanium Alloys
○	○	○	○	○	○

○ Most Suitable ○ Suitable

Recommended Cutting Data ※ P563

SS600-R5

5 Flutes, Corner Radius

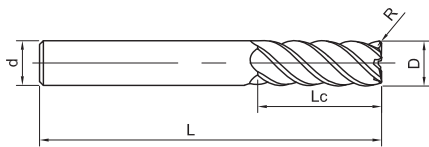

Fig1



Please refer to page 167

» Continuation

Ordering Code	D	R	Lc	L	d	Figure No.	Stock
SS600-R5-10010	10	1	25	75	10	1	●
SS600-R5-10010A	10	1	25	100	10	1	●
SS600-R5-10020	10	2	25	75	10	1	○
SS600-R5-10020A	10	2	25	100	10	1	○
SS600-R5-10030	10	3	25	75	10	1	○
SS600-R5-10030A	10	3	25	100	10	1	○
SS600-R5-12005	12	0.5	26	83	12	1	●
SS600-R5-12005A	12	0.5	26	100	12	1	○
SS600-R5-12005B	12	0.5	40	150	12	1	○
SS600-R5-12010	12	1	26	83	12	1	●
SS600-R5-12010A	12	1	26	100	12	1	○
SS600-R5-12010B	12	1	40	150	12	1	○
SS600-R5-12020	12	2	26	83	12	1	●
SS600-R5-12020A	12	2	26	100	12	1	○
SS600-R5-12020B	12	2	40	150	12	1	○
SS600-R5-12030	12	3	26	83	12	1	○

● Stock ○ Available upon Order

D	Tol
D < 6	0 -0.02
6 ≤ D ≤ 12	0 -0.03
D > 12	0 -0.04

Unit (mm)

Workpiece Material					
P		M	K	S	
1234	5	123	123	123	4
Carbon Steel, Alloy Steel (<35HRC)	Alloy Steel, Tool Steel (<48HRC)	Stainless Steel	Cast Iron	Heat-resistant Alloys	Titanium Alloys
○	○	○	○	○	○

○ Most Suitable ○ Suitable

Recommended Cutting Data ※ P563

SS600-R5

5 Flutes, Corner Radius

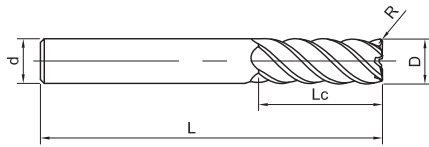

Fig1



Please refer to page 167

» Continuation

Ordering Code	D	R	Lc	L	d	Figure No.	Stock
SS600-R5-12030A	12	3	26	100	12	1	○
SS600-R5-12030B	12	3	40	150	12	1	○
SS600-R5-16005	16	0.5	32	92	16	1	○
SS600-R5-16005A	16	0.5	50	150	16	1	○
SS600-R5-16010	16	1	32	92	16	1	●
SS600-R5-16010A	16	1	50	150	16	1	○
SS600-R5-16020	16	2	32	92	16	1	●
SS600-R5-16020A	16	2	50	150	16	1	○
SS600-R5-16030	16	3	32	92	16	1	●
SS600-R5-16030A	16	3	50	150	16	1	○
SS600-R5-16040	16	4	32	92	16	1	○
SS600-R5-16040A	16	4	50	150	16	1	○
SS600-R5-16050	16	5	32	92	16	1	○
SS600-R5-16050A	16	5	50	150	16	1	○
SS600-R5-20005	20	0.5	38	100	20	1	○
SS600-R5-20005A	20	0.5	50	150	20	1	○

● Stock ○ Available upon Order

D	Tol
D < 6	0 -0.02
6 ≤ D ≤ 12	0 -0.03
D > 12	0 -0.04

Unit (mm)

Workpiece Material					
P		M	K	S	
1234	5	123	123	123	4
Carbon Steel, Alloy Steel (<35HRC)	Alloy Steel, Tool Steel (<48HRC)	Stainless Steel	Cast Iron	Heat-resistant Alloys	Titanium Alloys
○	○	○	○	○	○

○ Most Suitable ○ Suitable

Recommended Cutting Data ※ P563

SS600-R5

5 Flutes, Corner Radius

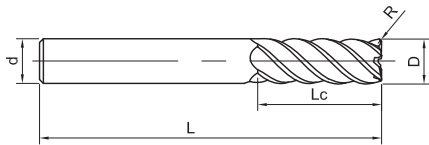

Fig1



Please refer to page 167

» Continuation

Ordering Code	D	R	Lc	L	d	Figure No.	Stock
SS600-R5-20010	20	1	38	100	20	1	●
SS600-R5-20010A	20	1	50	150	20	1	○
SS600-R5-20020	20	2	38	100	20	1	○
SS600-R5-20020A	20	2	50	150	20	1	○
SS600-R5-20030	20	3	38	100	20	1	○
SS600-R5-20030A	20	3	50	150	20	1	○
SS600-R5-20040	20	4	38	100	20	1	○
SS600-R5-20040A	20	4	50	150	20	1	○
SS600-R5-20050	20	5	38	100	20	1	○
SS600-R5-20050A	20	5	50	150	20	1	○
SS600-R5-25010	25	1	50	125	25	1	○
SS600-R5-25020	25	2	50	125	25	1	○
SS600-R5-25030	25	3	50	125	25	1	○
SS600-R5-25040	25	4	50	125	25	1	○
SS600-R5-25050	25	5	50	125	25	1	○

● Stock ○ Available upon Order

D	Tol
D < 6	0 -0.02
6 ≤ D ≤ 12	0 -0.03
D > 12	0 -0.04

Unit (mm)

Workpiece Material					
P		M	K	S	
1234	5	123	123	123	4
Carbon Steel, Alloy Steel (<35HRC)	Alloy Steel, Tool Steel (<48HRC)	Stainless Steel	Cast Iron	Heat-resistant Alloys	Titanium Alloys
○	○	○	○	○	○

○ Most Suitable ○ Suitable

Recommended Cutting Data ※ P563

SS600-B4

4 Flutes, Ballnose

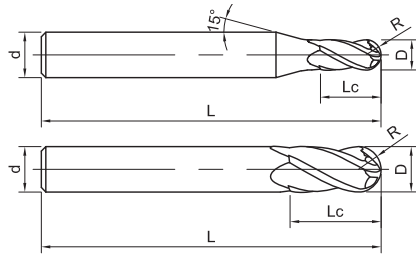

Fig1

Fig2



Please refer to page 167

Ordering Code	D	R	Lc	L	d	Figure No.	Stock
SS600-B4-02004	2	1	4	50	4	1	●
SS600-B4-04008	4	2	8	50	4	2	●
SS600-B4-06012	6	3	12	50	6	2	○
SS600-B4-08014	8	4	14	60	8	2	○
SS600-B4-10018	10	5	18	75	10	2	○
SS600-B4-12022	12	6	22	75	12	2	○
SS600-B4-16030	16	8	30	100	16	2	○
SS600-B4-20038	20	10	38	100	20	2	○

● Stock ○ Available upon Order

R	Tol
$R \geq 1$	± 0.02

Unit (mm)

Workpiece Material					
P		M	K	S	
1234	5	123	123	123	4
Carbon Steel, Alloy Steel (<35HRC)	Alloy Steel, Tool Steel (<48HRC)	Stainless Steel	Cast Iron	Heat-resistant Alloys	Titanium Alloys
○	○	○	○	○	○

○ Most Suitable ○ Suitable

Recommended Cutting Data ※ P563

UA100-S2

2 Flutes, Standard Length, Square

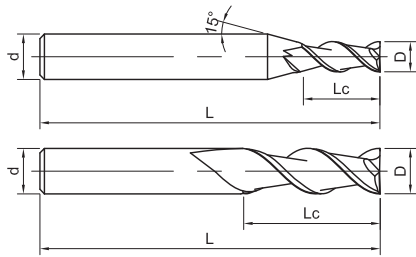

Fig1

Fig2



Please refer to page 167

Ordering Code	D	Lc	L	d	Figure No.	Stock
UA100-S2-01003	1	3	50	4	1	●
UA100-S2-01504	1.5	4	50	4	1	●
UA100-S2-02006	2	6	50	4	1	●
UA100-S2-03009	3	9	50	4	1	●
UA100-S2-63009	3	9	50	6	1	●
UA100-S2-04006	4	6	50	4	2	●
UA100-S2-04011	4	11	50	4	2	●
UA100-S2-64011	4	11	50	6	1	●
UA100-S2-04512	4.5	12	50	6	1	●
UA100-S2-05013	5	13	50	6	1	●
UA100-S2-05516	5.5	16	50	6	1	●
UA100-S2-06006	6	6	50	6	2	●
UA100-S2-06012	6	12	50	6	2	●
UA100-S2-06016	6	16	50	6	2	●
UA100-S2-07020	7	20	60	8	1	●
UA100-S2-08020	8	20	60	8	2	●
UA100-S2-09023	9	23	75	10	1	●
UA100-S2-10025	10	25	75	10	2	●
UA100-S2-12030	12	30	75	12	2	●
UA100-S2-16036	16	36	100	16	2	●
UA100-S2-20045	20	45	100	20	2	●

● Stock ○ Available upon Order

D	Tol
D ≤ 12	0 -0.02
D > 12	0 -0.03

Unit (mm)

Workpiece Material						
P		M	K	N		
1234	5	123	123	123	4	5
Carbon Steel, Alloy Steel (<35HRC)	Alloy Steel, Tool Steel (<48HRC)	Stainless Steel	Cast Iron	Aluminium Alloys	Copper Alloys	Graphite
				⊙	⊙	

⊙ Most Suitable ○ Suitable

Recommended Cutting Data ※ P564

UA100-SL2

2 Flutes, Long Flute Length, Square

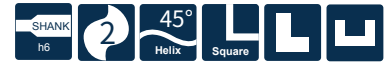
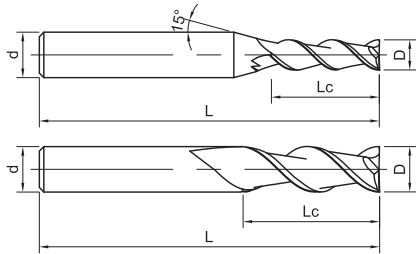

Please refer to page 167

Ordering Code	D	Lc	L	d	Figure No.	Stock
UA100-SL2-02020	2	20	75	4	1	●
UA100-SL2-03025	3	25	75	4	1	●
UA100-SL2-04030	4	30	75	4	2	●
UA100-SL2-05030	5	30	75	6	1	●
UA100-SL2-06035	6	35	75	6	2	●
UA100-SL2-08040	8	40	100	8	2	●
UA100-SL2-10045	10	45	100	10	2	●
UA100-SL2-12050	12	50	100	12	2	●
UA100-SL2-16060	16	60	150	16	2	●
UA100-SL2-20070	20	70	150	20	2	●

● Stock ○ Available upon Order

D	Tol
D ≤ 12	0 -0.02
D > 12	0 -0.03

Unit (mm)

Workpiece Material						
P		M	K	N		
1234	5	123	123	123	4	5
Carbon Steel, Alloy Steel (<35HRC)	Alloy Steel, Tool Steel (<48HRC)	Stainless Steel	Cast Iron	Aluminium Alloys	Copper Alloys	Graphite
				⊙	⊙	

⊙ Most Suitable ○ Suitable

Recommended Cutting Data ※ P564

UA100-SH2

2 Flutes, with Long Shank, Square

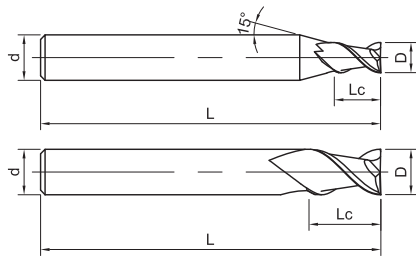

Fig1

Fig2



Please refer to page 167

Ordering Code	D	Lc	L	d	Figure No.	Stock
UA100-SH2-02006	2	6	75	4	1	●
UA100-SH2-03009	3	9	75	4	1	●
UA100-SH2-04010	4	10	75	4	2	●
UA100-SH2-04011	4	11	75	4	2	●
UA100-SH2-06015	6	15	75	6	2	●
UA100-SH2-06016	6	16	75	6	2	●
UA100-SH2-08020	8	20	100	8	2	●
UA100-SH2-10025	10	25	100	10	2	●
UA100-SH2-12030	12	30	100	12	2	●
UA100-SH2-16036	16	36	150	16	2	●
UA100-SH2-20045	20	45	150	20	2	○

● Stock ○ Available upon Order

D	Tol
D ≤ 12	0 -0.02
D > 12	0 -0.03

Unit (mm)

Workpiece Material						
P		M	K	N		
1234	5	123	123	123	4	5
Carbon Steel, Alloy Steel (<35HRC)	Alloy Steel, Tool Steel (<48HRC)	Stainless Steel	Cast Iron	Aluminium Alloys	Copper Alloys	Graphite
				⊙	⊙	

⊙ Most Suitable ○ Suitable

Recommended Cutting Data ※ P564

UA100-S3

3 Flutes, Square

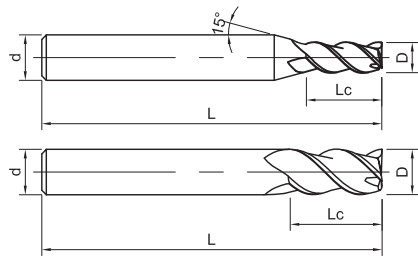

Fig1

Fig2



Please refer to page 167

Ordering Code	D	Lc	L	d	Figure No.	Stock
UA100-S3-01003	1	3	50	4	1	●
UA100-S3-01504	1.5	4	50	4	1	●
UA100-S3-02006	2	6	50	4	1	●
UA100-S3-02508	2.5	8	50	4	1	●
UA100-S3-03009	3	9	50	4	1	●
UA100-S3-63009	3	9	50	6	2	●
UA100-S3-04011	4	11	50	4	2	●
UA100-S3-64011	4	11	50	6	1	●
UA100-S3-05013	5	13	50	6	1	●
UA100-S3-06012	6	12	50	6	2	●
UA100-S3-06016	6	16	50	6	2	●
UA100-S3-07020	7	20	60	8	1	●
UA100-S3-08020	8	20	60	8	2	●
UA100-S3-09023	9	23	75	10	1	●
UA100-S3-10025	10	25	75	10	2	●
UA100-S3-12030	12	30	75	12	2	●
UA100-S3-16036	16	36	100	16	2	●
UA100-S3-18038	18	38	100	18	2	●
UA100-S3-20045	20	45	100	20	2	●

● Stock ○ Available upon Order

D	Tol
D ≤ 12	0 -0.02
D > 12	0 -0.03

Unit (mm)

Workpiece Material						
P		M	K	N		
1234	5	123	123	123	4	5
Carbon Steel, Alloy Steel (<35HRC)	Alloy Steel, Tool Steel (<48HRC)	Stainless Steel	Cast Iron	Aluminium Alloys	Copper Alloys	Graphite
				⊙	⊙	

⊙ Most Suitable ○ Suitable

Recommended Cutting Data ※ P565

UA100-SL3

3 Flutes, Long Flute, Square

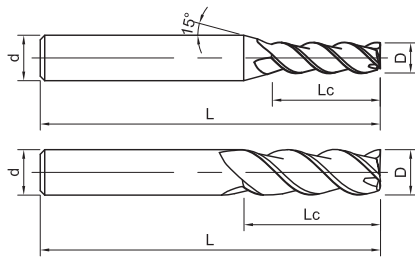
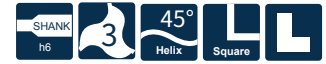

Fig1

Fig2



Please refer to page 167

Ordering Code	D	Lc	L	d	Figure No.	Stock
UA100-SL3-02020	2	20	75	4	1	●
UA100-SL3-03025	3	25	75	4	1	●
UA100-SL3-04030	4	30	75	4	2	●
UA100-SL3-05030	5	30	75	6	1	●
UA100-SL3-06035	6	35	75	6	2	●
UA100-SL3-08040	8	40	100	8	2	●
UA100-SL3-10045	10	45	100	10	2	●
UA100-SL3-12050	12	50	100	12	2	●
UA100-SL3-16060	16	60	150	16	2	●
UA100-SL3-20070	20	70	150	20	2	●

● Stock ○ Available upon Order

D	Tol
D ≤ 12	0 -0.02
D > 12	0 -0.03

Unit (mm)

Workpiece Material						
P		M	K	N		
1234	5	123	123	123	4	5
Carbon Steel, Alloy Steel (<35HRC)	Alloy Steel, Tool Steel (<48HRC)	Stainless Steel	Cast Iron	Aluminium Alloys	Copper Alloys	Graphite
				⊙	⊙	

⊙ Most Suitable ○ Suitable

Recommended Cutting Data ※ P565

UA100-SH3

3 Flutes, Long Shank, Square

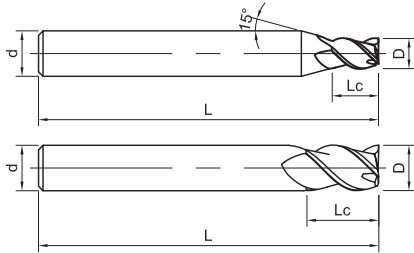

Fig1

Fig2



Please refer to page 167

Ordering Code	D	Lc	L	d	Figure No.	Stock
UA100-SH3-02008	2	8	75	4	1	●
UA100-SH3-03010	3	10	75	4	1	●
UA100-SH3-04012	4	12	75	4	2	●
UA100-SH3-06016	6	16	75	6	2	●
UA100-SH3-08020	8	20	100	8	2	●
UA100-SH3-10025	10	25	100	10	2	●
UA100-SH3-12030	12	30	100	12	2	●
UA100-SH3-16036	16	36	150	16	2	●
UA100-SH3-20045	20	45	150	20	2	●

● Stock ○ Available upon Order

D	Tol
D ≤ 12	0 -0.02
D > 12	0 -0.03

Unit (mm)

Workpiece Material						
P		M	K	N		
1234	5	123	123	123	4	5
Carbon Steel, Alloy Steel (<35HRC)	Alloy Steel, Tool Steel (<48HRC)	Stainless Steel	Cast Iron	Aluminium Alloys	Copper Alloys	Graphite
				⊙	⊙	

⊙ Most Suitable ○ Suitable

Recommended Cutting Data ※ P565

UA100-R2

2 Flutes, Corner Radius

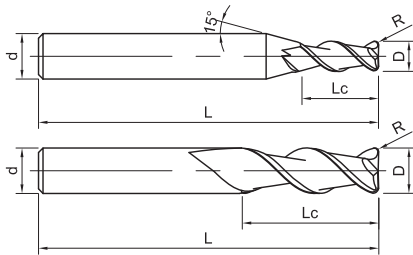

Fig1

Fig2



Please refer to page 167

Ordering Code	D	Lc	R	L	d	Figure No.	Stock
UA100-R2-01001	1	3	0.1	50	4	1	●
UA100-R2-02002	2	6	0.2	50	4	1	●
UA100-R2-03002	3	9	0.2	50	4	1	○
UA100-R2-03003	3	9	0.3	50	4	1	●
UA100-R2-63003	3	9	0.3	50	6	1	●
UA100-R2-03005	3	9	0.5	50	4	1	○
UA100-R2-63005	3	9	0.5	50	6	1	●
UA100-R2-04002	4	11	0.2	50	4	2	●
UA100-R2-04003	4	11	0.3	50	4	2	●
UA100-R2-64003	4	11	0.3	50	6	1	●
UA100-R2-04005	4	11	0.5	50	4	2	○
UA100-R2-64005	4	11	0.5	50	6	1	●
UA100-R2-04010	4	11	1	50	4	2	●
UA100-R2-05002	5	13	0.2	50	6	1	●

● Stock ○ Available upon Order

D	Tol
D ≤ 12	0 -0.02
D > 12	0 -0.03

Unit (mm)

Workpiece Material						
P		M	K	N		
1234	5	123	123	123	4	5
Carbon Steel, Alloy Steel (<35HRC)	Alloy Steel, Tool Steel (<48HRC)	Stainless Steel	Cast Iron	Aluminium Alloys	Copper Alloys	Graphite
				⊙	⊙	

⊙ Most Suitable ○ Suitable

Recommended Cutting Data ※ P564

UA100-R2

2 Flutes, Corner Radius

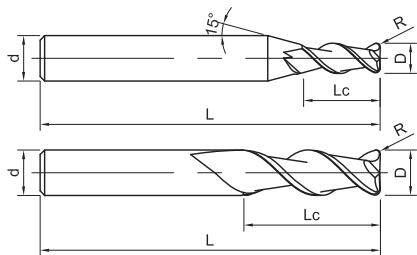

Fig1

Fig2



Please refer to page 167

» Continuation

Ordering Code	D	Lc	R	L	d	Figure No.	Stock
UA100-R2-05003	5	13	0.3	50	6	1	●
UA100-R2-05005	5	13	0.5	50	6	1	●
UA100-R2-05010	5	13	1	50	6	1	●
UA100-R2-05015	5	13	1.5	50	6	1	●
UA100-R2-06005	6	16	0.5	50	6	2	●
UA100-R2-06010	6	16	1	50	6	2	●
UA100-R2-06015	6	16	1.5	50	6	2	●
UA100-R2-06020	6	16	2	50	6	2	●
UA100-R2-08005	8	20	0.5	60	8	2	●
UA100-R2-08010	8	20	1	60	8	2	●
UA100-R2-08015	8	20	1.5	60	8	2	○
UA100-R2-08020	8	20	2	60	8	2	●
UA100-R2-10005	10	25	0.5	75	10	2	●
UA100-R2-10010	10	25	1	75	10	2	●
UA100-R2-10015	10	25	1.5	75	10	2	●
UA100-R2-10020	10	25	2	75	10	2	●

●Stock ○Available upon Order

D	Tol
D ≤ 12	0 -0.02
D > 12	0 -0.03

Unit (mm)

Workpiece Material						
P		M	K	N		
1234	5	123	123	123	4	5
Carbon Steel, Alloy Steel (<35HRC)	Alloy Steel, Tool Steel (<48HRC)	Stainless Steel	Cast Iron	Aluminium Alloys	Copper Alloys	Graphite
				○	○	

○ Most Suitable ○ Suitable

Recommended Cutting Data ※ P564

UA100-R2

2 Flutes, Corner Radius

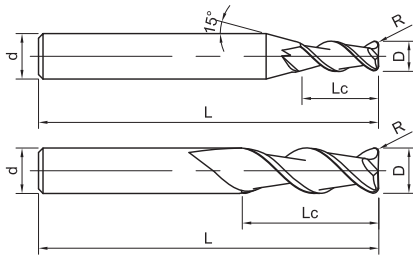
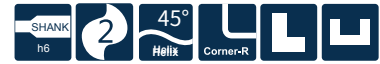

Fig1

Fig2



Please refer to page 167

» Continuation

Ordering Code	D	Lc	R	L	d	Figure No.	Stock
UA100-R2-10025	10	25	2.5	75	10	2	●
UA100-R2-12005	12	30	0.5	75	12	2	●
UA100-R2-12010	12	30	1	75	12	2	●
UA100-R2-12015	12	30	1.5	75	12	2	●
UA100-R2-12020	12	30	2	75	12	2	●
UA100-R2-12025	12	30	2.5	75	12	2	●
UA100-R2-16005	16	36	0.5	100	16	2	●
UA100-R2-16010	16	36	1	100	16	2	○
UA100-R2-16015	16	36	1.5	100	16	2	○
UA100-R2-16020	16	36	2	100	16	2	●
UA100-R2-16025	16	36	2.5	100	16	2	●
UA100-R2-20005	20	45	0.5	100	20	2	●
UA100-R2-20010	20	45	1	100	20	2	●
UA100-R2-20015	20	45	1.5	100	20	2	●
UA100-R2-20020	20	45	2	100	20	2	○
UA100-R2-20030	20	45	3	100	20	2	○

● Stock ○ Available upon Order

D	Tol
D ≤ 12	0 -0.02
D > 12	0 -0.03

Unit (mm)

Workpiece Material						
P		M	K	N		
1234	5	123	123	123	4	5
Carbon Steel, Alloy Steel (<35HRC)	Alloy Steel, Tool Steel (<48HRC)	Stainless Steel	Cast Iron	Aluminium Alloys	Copper Alloys	Graphite
				⊙	⊙	

⊙ Most Suitable ○ Suitable

Recommended Cutting Data ※ P564

UA100-RH2

2 Flutes, Corner Radius, Long Shank

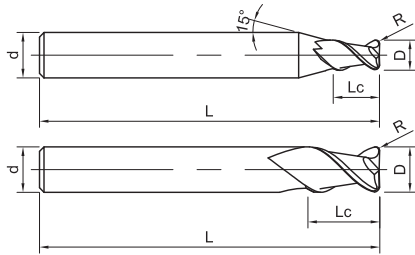

Fig1

Fig2



Please refer to page 167

Ordering Code	D	Lc	R	L	d	Figure No.	Stock
UA100-RH2-06005	6	16	0.5	75	6	2	●
UA100-RH2-06010	6	16	1	75	6	2	●
UA100-RH2-06015	6	16	1.5	75	6	2	●
UA100-RH2-06020	6	16	2	75	6	2	●
UA100-RH2-08005	8	20	0.5	100	8	2	●
UA100-RH2-08010	8	20	1	100	8	2	●
UA100-RH2-08015	8	20	1.5	100	8	2	●
UA100-RH2-08020	8	20	2	100	8	2	●
UA100-RH2-10005	10	25	0.5	100	10	2	●
UA100-RH2-10010	10	25	1	100	10	2	●
UA100-RH2-10015	10	25	1.5	100	10	2	●
UA100-RH2-10020	10	25	2	100	10	2	●
UA100-RH2-10025	10	25	2.5	100	10	2	○
UA100-RH2-12005	12	30	0.5	100	12	2	●

● Stock ○ Available upon Order

D	Tol
D ≤ 12	0 -0.02
D > 12	0 -0.03

Unit (mm)

Workpiece Material						
P		M	K	N		
1234	5	123	123	123	4	5
Carbon Steel, Alloy Steel (<35HRC)	Alloy Steel, Tool Steel (<48HRC)	Stainless Steel	Cast Iron	Aluminium Alloys	Copper Alloys	Graphite
				⊙	⊙	

⊙ Most Suitable ○ Suitable

Recommended Cutting Data ※ P564

UA100-RH2

2 Flutes, Corner Radius, Long Shank

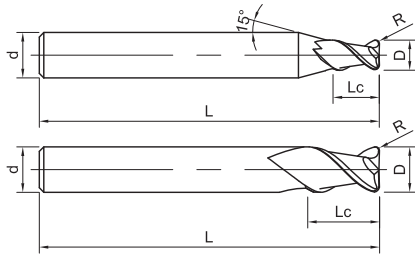

Fig1

Fig2



Please refer to page 167

» Continuation

Ordering Code	D	Lc	R	L	d	Figure No.	Stock
UA100-RH2-12010	12	30	1	100	12	2	○
UA100-RH2-12015	12	30	1.5	100	12	2	○
UA100-RH2-12020	12	30	2	100	12	2	●
UA100-RH2-12025	12	30	2.5	100	12	2	○
UA100-RH2-16005	16	36	0.5	150	16	2	●
UA100-RH2-16010	16	36	1	150	16	2	○
UA100-RH2-16015	16	36	1.5	150	16	2	○
UA100-RH2-16020	16	36	2	150	16	2	○
UA100-RH2-16025	16	36	2.5	150	16	2	○
UA100-RH2-20005	20	45	0.5	150	20	2	●
UA100-RH2-20010	20	45	1	150	20	2	●
UA100-RH2-20015	20	45	1.5	150	20	2	●
UA100-RH2-20020	20	45	2	150	20	2	○
UA100-RH2-20030	20	45	3	150	20	2	○

● Stock ○ Available upon Order

D	Tol
D ≤ 12	0 -0.02
D > 12	0 -0.03

Unit (mm)

Workpiece Material						
P		M	K	N		
1234	5	123	123	123	4	5
Carbon Steel, Alloy Steel (<35HRC)	Alloy Steel, Tool Steel (<48HRC)	Stainless Steel	Cast Iron	Aluminium Alloys	Copper Alloys	Graphite
				⊙	⊙	

⊙ Most Suitable ○ Suitable

Recommended Cutting Data ※ P564

UA100-R3

3 Flutes, Corner Radius

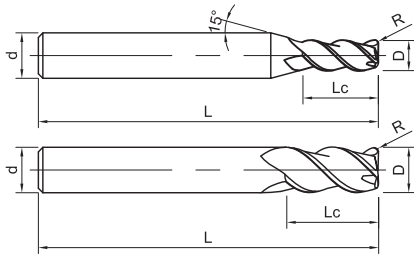

Fig1

Fig2



Please refer to page 167

Ordering Code	D	Lc	R	L	d	Figure No.	Stock
UA100-R3-01001	1	3	0.1	50	4	1	●
UA100-R3-02002	2	6	0.2	50	4	1	●
UA100-R3-03002	3	9	0.2	50	4	1	●
UA100-R3-03003	3	9	0.3	50	4	1	●
UA100-R3-03005	3	9	0.5	50	4	1	●
UA100-R3-04002	4	11	0.2	50	4	2	●
UA100-R3-04003	4	11	0.3	50	4	2	●
UA100-R3-04005	4	11	0.5	50	4	2	●
UA100-R3-04010	4	11	1	50	4	2	●
UA100-R3-05002	5	13	0.2	50	6	1	●
UA100-R3-05003	5	13	0.3	50	6	1	●
UA100-R3-05005	5	13	0.5	50	6	1	●
UA100-R3-05010	5	13	1	50	6	1	●
UA100-R3-05015	5	13	1.5	50	6	1	●
UA100-R3-06005	6	16	0.5	50	6	2	●
UA100-R3-06010	6	16	1	50	6	2	●

● Stock ○ Available upon Order

D	Tol
D ≤ 12	0 -0.02
D > 12	0 -0.03

Unit (mm)

Workpiece Material						
P		M	K	N		
1234	5	123	123	123	4	5
Carbon Steel, Alloy Steel (<35HRC)	Alloy Steel, Tool Steel (<48HRC)	Stainless Steel	Cast Iron	Aluminium Alloys	Copper Alloys	Graphite
				○	○	

○ Most Suitable ○ Suitable

Recommended Cutting Data ※ P565

UA100-R3

3 Flutes, Corner Radius

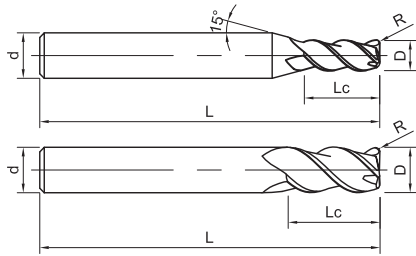

Fig1

Fig2



Please refer to page 167

» Continuation

Ordering Code	D	Lc	R	L	d	Figure No.	Stock
UA100-R3-06015	6	16	1.5	50	6	2	●
UA100-R3-06020	6	16	2	50	6	2	●
UA100-R3-08005	8	20	0.5	60	8	2	●
UA100-R3-08010	8	20	1	60	8	2	●
UA100-R3-08015	8	20	1.5	60	8	2	●
UA100-R3-08020	8	20	2	60	8	2	●
UA100-R3-08030	8	20	3	60	8	2	●
UA100-R3-10005	10	25	0.5	75	10	2	●
UA100-R3-10010	10	25	1	75	10	2	●
UA100-R3-10015	10	25	1.5	75	10	2	●
UA100-R3-10020	10	25	2	75	10	2	●
UA100-R3-10025	10	25	2.5	75	10	2	●
UA100-R3-10030	10	25	3	75	10	2	●
UA100-R3-12005	12	30	0.5	75	12	2	●
UA100-R3-12010	12	30	1	75	12	2	●
UA100-R3-12015	12	30	1.5	75	12	2	●

● Stock ○ Available upon Order

D	Tol
D ≤ 12	0 -0.02
D > 12	0 -0.03

Unit (mm)

Workpiece Material						
P		M	K	N		
1234	5	123	123	123	4	5
Carbon Steel, Alloy Steel (<35HRC)	Alloy Steel, Tool Steel (<48HRC)	Stainless Steel	Cast Iron	Aluminium Alloys	Copper Alloys	Graphite
				⊙	⊙	

⊙ Most Suitable ○ Suitable

Recommended Cutting Data ※ P565

UA100-R3

3 Flutes, Corner Radius

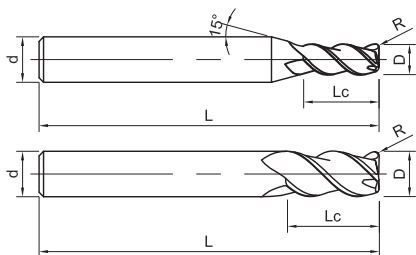

Fig1

Fig2



Please refer to page 167

» Continuation

Ordering Code	D	Lc	R	L	d	Figure No.	Stock
UA100-R3-12020	12	30	2	75	12	2	●
UA100-R3-12025	12	30	2.5	75	12	2	●
UA100-R3-12030	12	30	3	75	12	2	●
UA100-R3-16005	16	36	0.5	100	16	2	●
UA100-R3-16010	16	36	1	100	16	2	●
UA100-R3-16015	16	36	1.5	100	16	2	○
UA100-R3-16020	16	36	2	100	16	2	●
UA100-R3-16025	16	36	2.5	100	16	2	○
UA100-R3-16030	16	36	3	100	16	2	●
UA100-R3-20005	20	45	0.5	100	20	2	○
UA100-R3-20010	20	45	1	100	20	2	●
UA100-R3-20015	20	45	1.5	100	20	2	○
UA100-R3-20020	20	45	2	100	20	2	●
UA100-R3-20030	20	45	3	100	20	2	●

● Stock ○ Available upon Order

D	Tol
D ≤ 12	0 -0.02
D > 12	0 -0.03

Unit (mm)

Workpiece Material						
P		M	K	N		
1234	5	123	123	123	4	5
Carbon Steel, Alloy Steel (<35HRC)	Alloy Steel, Tool Steel (<48HRC)	Stainless Steel	Cast Iron	Aluminium Alloys	Copper Alloys	Graphite
				◎	◎	

◎ Most Suitable ○ Suitable

Recommended Cutting Data ※ P565

UA100-RH3

3 Flutes, Corner Radius, Long Shank

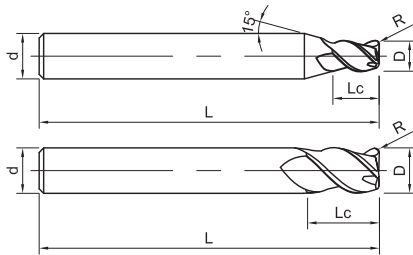

Fig1

Fig2



Please refer to page 167

Ordering Code	D	Lc	R	L	d	Figure No.	Stock
UA100-RH3-06005	6	16	0.5	75	6	2	●
UA100-RH3-06010	6	16	1	75	6	2	●
UA100-RH3-06015	6	16	1.5	75	6	2	●
UA100-RH3-06020	6	16	2	75	6	2	●
UA100-RH3-08005	8	20	0.5	100	8	2	●
UA100-RH3-08010	8	20	1	100	8	2	●
UA100-RH3-08015	8	20	1.5	100	8	2	●
UA100-RH3-08020	8	20	2	100	8	2	●
UA100-RH3-10005	10	25	0.5	100	10	2	●
UA100-RH3-10010	10	25	1	100	10	2	●
UA100-RH3-10015	10	25	1.5	100	10	2	●
UA100-RH3-10020	10	25	2	100	10	2	●
UA100-RH3-10025	10	25	2.5	100	10	2	●
UA100-RH3-12005	12	30	0.5	100	12	2	●

● Stock ○ Available upon Order

D	Tol
D ≤ 12	0 -0.02
D > 12	0 -0.03

Unit (mm)

Workpiece Material						
P		M	K	N		
1234	5	123	123	123	4	5
Carbon Steel, Alloy Steel (<35HRC)	Alloy Steel, Tool Steel (<48HRC)	Stainless Steel	Cast Iron	Aluminium Alloys	Copper Alloys	Graphite
				⊙	⊙	

⊙ Most Suitable ○ Suitable

Recommended Cutting Data ※ P565

UA100-RH3

3 Flutes, Corner Radius, Long Shank

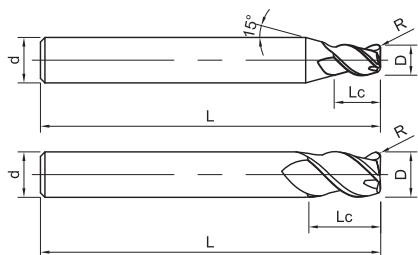

Fig1

Fig2



Please refer to page 167

» Continuation

Ordering Code	D	Lc	R	L	d	Figure No.	Stock
UA100-RH3-12010	12	30	1	100	12	2	●
UA100-RH3-12015	12	30	1.5	100	12	2	●
UA100-RH3-12020	12	30	2	100	12	2	●
UA100-RH3-12025	12	30	2.5	100	12	2	●
UA100-RH3-16005	16	36	0.5	150	16	2	○
UA100-RH3-16010	16	36	1	150	16	2	○
UA100-RH3-16015	16	36	1.5	150	16	2	●
UA100-RH3-16020	16	36	2	150	16	2	●
UA100-RH3-16025	16	36	2.5	150	16	2	●
UA100-RH3-20005	20	45	0.5	150	20	2	●
UA100-RH3-20010	20	45	1	150	20	2	●
UA100-RH3-20015	20	45	1.5	150	20	2	●
UA100-RH3-20020	20	45	2	150	20	2	○
UA100-RH3-20030	20	45	3	150	20	2	●

● Stock ○ Available upon Order

D	Tol
D ≤ 12	0 -0.02
D > 12	0 -0.03

Unit (mm)

Workpiece Material						
P		M	K	N		
1234	5	123	123	123	4	5
Carbon Steel, Alloy Steel (<35HRC)	Alloy Steel, Tool Steel (<48HRC)	Stainless Steel	Cast Iron	Aluminium Alloys	Copper Alloys	Graphite
				⊙	⊙	

⊙ Most Suitable ○ Suitable

Recommended Cutting Data ※ P565

UA100-B2

2 Flutes, Ballnose

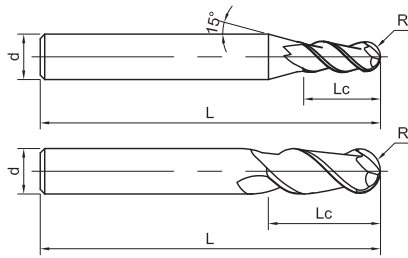
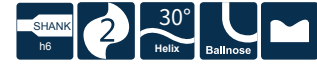

Fig1

Fig2



Please refer to page 167

Ordering Code	D	Lc	R	L	d	Figure No.	Stock
UA100-B2-01002	1	2	0.5	50	4	1	●
UA100-B2-02004	2	4	1	50	4	1	●
UA100-B2-03006	3	6	1.5	50	4	1	●
UA100-B2-63006	3	6	1.5	50	6	1	●
UA100-B2-04008	4	8	2	50	4	2	●
UA100-B2-64008	4	8	2	50	6	1	●
UA100-B2-05010	5	10	2.5	50	6	1	●
UA100-B2-06012	6	12	3	50	6	2	●
UA100-B2-07014	7	14	3.5	60	8	1	●
UA100-B2-08014	8	14	4	60	8	2	●
UA100-B2-09016	9	16	4.5	75	10	1	●
UA100-B2-10018	10	18	5	75	10	2	●
UA100-B2-12022	12	22	6	75	12	2	●
UA100-B2-16026	16	26	8	100	16	2	●

● Stock ○ Available upon Order

R	Tol
R < 3	±0.015
R ≥ 3	±0.02

Unit (mm)

Workpiece Material						
P		M	K	N		
1234	5	123	123	123	4	5
Carbon Steel, Alloy Steel (<35HRC)	Alloy Steel, Tool Steel (<48HRC)	Stainless Steel	Cast Iron	Aluminium Alloys	Copper Alloys	Graphite
				⊙	⊙	

⊙ Most Suitable ○ Suitable

Recommended Cutting Data ※ P566

SA100-S3

3 Flutes, Standard Length, Square

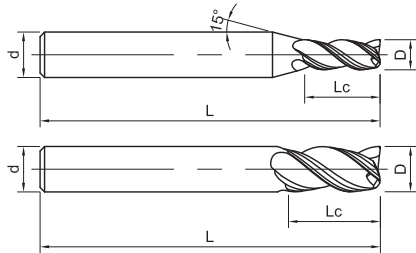

Fig1

Fig2



Please refer to page 167

Ordering Code	D	Lc	L	d	Figure No.	Stock
SA100-S3-03009	3	9	50	6	1	●
SA100-S3-04011	4	11	50	6	1	●
SA100-S3-05013	5	13	50	6	1	●
SA100-S3-06012	6	12	50	6	2	●
SA100-S3-06016	6	16	50	6	2	●
SA100-S3-08020	8	20	60	8	2	●
SA100-S3-10025	10	25	75	10	2	●
SA100-S3-12030	12	30	75	12	2	●
SA100-S3-16036	16	36	100	16	2	●
SA100-S3-20045	20	45	100	20	2	●

● Stock ○ Available upon Order

D	Tol
D ≤ 10	0 -0.01
D > 10	0 -0.02

Unit (mm)

Workpiece Material						
P		M	K	N		
1234	5	123	123	123	4	5
Carbon Steel, Alloy Steel (<35HRC)	Alloy Steel, Tool Steel (<48HRC)	Stainless Steel	Cast Iron	Aluminium Alloys	Copper Alloys	Graphite
				⊙	⊙	

⊙ Most Suitable ○ Suitable

Recommended Cutting Data ※ P566

SA160-S3 NEW

3 Flutes, Standard Length, Square

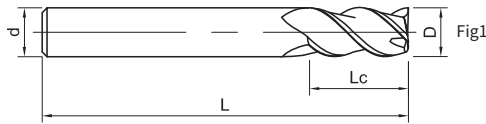

Please refer to page 167

Ordering Code	D	Lc	L	d	Figure No.	Stock
SA160-S3-04011	4	11	50	4	1	●
SA160-S3-06016	6	16	50	6	1	●
SA160-S3-06018	6	18	50	6	1	●
SA160-S3-08020	8	20	60	8	1	●
SA160-S3-08024	8	24	60	8	1	●
SA160-S3-10025	10	25	70	10	1	●
SA160-S3-10030	10	30	70	10	1	●
SA160-S3-12030	12	30	75	12	1	●
SA160-S3-12036	12	36	75	12	1	○
SA160-S3-16036	16	36	100	16	1	○
SA160-S3-20045	20	45	100	20	1	○

● Stock ○ Available upon Order

D	Tol
D ≤ 10	0 -0.01
D > 10	0 -0.02

Unit(mm)

Workpiece Material						
P		M	K	N		
1234	5	123	123	123	4	5
Carbon Steel, Alloy Steel (<35HRC)	Alloy Steel, Tool Steel (<48HRC)	Stainless Steel	Cast Iron	Aluminium Alloys	Copper Alloys	Graphite
				⊙		

⊙ Most Suitable ○ Suitable

Recommended Cutting Data ※ P566

SA160-SL3

NEW

3 Flutes, Long Flute, Square

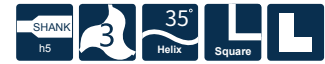
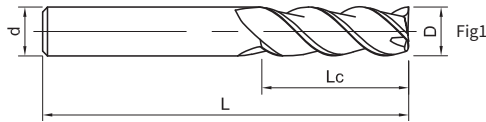

Please refer to page 167

Ordering Code	D	Lc	L	d	Figure No.	Stock
SA160-SL3-04020	4	20	60	4	1	○
SA160-SL3-06030	6	30	75	6	1	○
SA160-SL3-08040	8	40	75	8	1	○
SA160-SL3-10050	10	50	100	10	1	○
SA160-SL3-12060	12	60	100	12	1	○
SA160-SL3-16080	16	80	140	16	1	○
SA160-SL3-20080	20	80	150	20	1	○

● Stock ○ Available upon Order

D	Tol
D ≤ 10	0 -0.01
D > 10	0 -0.02

Unit(mm)

Workpiece Material						
P		M	K	N		
1234	5	123	123	123	4	5
Carbon Steel, Alloy Steel (<35HRC)	Alloy Steel, Tool Steel (<48HRC)	Stainless Steel	Cast Iron	Aluminium Alloys	Copper Alloys	Graphite
				◎		

◎ Most Suitable ○ Suitable

Recommended Cutting Data ※ P566

SA160-S4 NEW

4 Flutes, Standard Length, Square

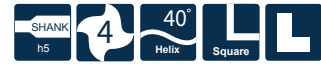
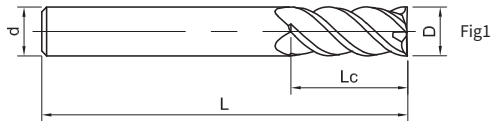

Please refer to page 167

Ordering Code	D	Lc	L	d	Figure No.	Stock
SA160-S4-04011	4	11	50	4	1	●
SA160-S4-06016	6	16	50	6	1	●
SA160-S4-08020	8	20	60	8	1	●
SA160-S4-10025	10	25	70	10	1	●
SA160-S4-12030	12	30	75	12	1	●
SA160-S4-16036	16	36	100	16	1	○
SA160-S4-20045	20	45	100	20	1	○

● Stock ○ Available upon Order

D	Tol
D ≤ 10	0 -0.01
D > 10	0 -0.02

Unit(mm)

Workpiece Material						
P		M	K	N		
1234	5	123	123	123	4	5
Carbon Steel, Alloy Steel (<35HRC)	Alloy Steel, Tool Steel (<48HRC)	Stainless Steel	Cast Iron	Aluminium Alloys	Copper Alloys	Graphite
				⊙		

⊙ Most Suitable ○ Suitable

Recommended Cutting Data ※ P566

SA160-SS4

NEW

4 Flutes, Stub Length, Square

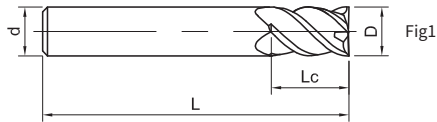

Please refer to page 167

Ordering Code	D	Lc	L	d	Figure No.	Stock
SA160-SS4-04008	4	8	50	4	1	●
SA160-SS4-06012	6	12	50	6	1	●
SA160-SS4-08015	8	15	50	8	1	●
SA160-SS4-10015	10	15	50	10	1	●
SA160-SS4-12015	12	15	50	12	1	○
SA160-SS4-16020	16	20	60	16	1	○
SA160-SS4-20030	20	30	75	20	1	○

● Stock ○ Available upon Order

D	Tol
D ≤ 10	0 -0.01
D > 10	0 -0.02

Unit(mm)

Workpiece Material						
P		M	K	N		
1234	5	123	123	123	4	5
Carbon Steel, Alloy Steel (<35HRC)	Alloy Steel, Tool Steel (<48HRC)	Stainless Steel	Cast Iron	Aluminium Alloys	Copper Alloys	Graphite
				◎		

◎ Most Suitable ○ Suitable

Recommended Cutting Data ※ P566

SA210-WR NEW

3 Flutes, Corner Radius, Long Neck

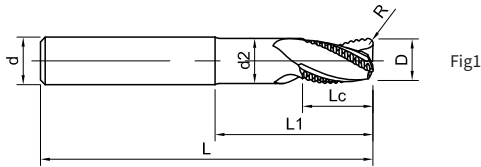

Please refer to page 167

Ordering Code	D	R	Lc	L1	d2	L	d	Figure No.	Stock
SA210-WR-12010	12	1	16	48	11.5	100	12	1	●
SA210-WR-12020	12	2	16	48	11.5	100	12	1	●
SA210-WR-12030	12	3	16	48	11.5	100	12	1	●
SA210-WR-16010	16	1	20	65	15.2	115	16	1	●
SA210-WR-16010A	16	1	24	42	15.2	92	16	1	●
SA210-WR-16020	16	2	20	65	15.2	115	16	1	○
SA210-WR-16020A	16	2	24	42	15.2	92	16	1	●
SA210-WR-16030	16	3	20	65	15.2	115	16	1	●
SA210-WR-16030A	16	3	24	42	15.2	92	16	1	●
SA210-WR-20010	20	1	25	73	19	125	20	1	●
SA210-WR-20010A	20	1	30	52	19	104	20	1	●
SA210-WR-20020	20	2	25	73	19	125	20	1	●
SA210-WR-20020A	20	2	30	52	19	104	20	1	●
SA210-WR-20020B	20	2	20	88	19	140	20	1	●
SA210-WR-20030	20	3	25	73	19	125	20	1	●

● Stock ○ Available upon Order

D	Tol
D ≤ 16	0 -0.05
D > 16	0 -0.06

Unit(mm)

Workpiece Material						
P		M	K	N		
1234	5	123	123	123	4	5
Carbon Steel, Alloy Steel (<35HRC)	Alloy Steel, Tool Steel (<48HRC)	Stainless Steel	Cast Iron	Aluminium Alloys	Copper Alloys	Graphite
				◎		

◎ Most Suitable ○ Suitable

Recommended Cutting Data ※ P567

SA210-WR NEW

3 Flutes, Corner Radius, Long Neck

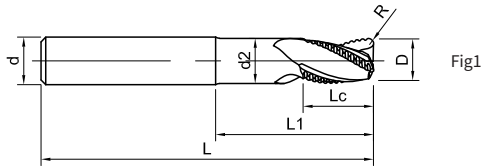

Fig1



Please refer to page 167

» Continuation

Ordering Code	D	R	Lc	L1	d2	L	d	Figure No.	Stock
SA210-WR-20030A	20	3	30	52	19	104	20	1	●
SA210-WR-20030B	20	3	20	88	19	140	20	1	●
SA210-WR-20040	20	4	25	73	19	125	20	1	●
SA210-WR-20050	20	5	25	73	19	125	20	1	○
SA210-WR-20050A	20	5	30	52	19	104	20	1	●
SA210-WR-25010	25	1	30	72	23.75	130	25	1	●
SA210-WR-25010B	25	1	25	92	23.75	150	25	1	●
SA210-WR-25020	25	2	30	72	23.75	130	25	1	●
SA210-WR-25020A	25	2	37	52	23.75	110	25	1	●
SA210-WR-25020B	25	2	25	92	23.75	150	25	1	●
SA210-WR-25030	25	3	30	72	23.75	130	25	1	●
SA210-WR-25030A	25	3	37	52	23.75	110	25	1	●
SA210-WR-25030B	25	3	25	92	23.75	150	25	1	●
SA210-WR-25030C	25	3	35	100	23.75	150	25	1	●
SA210-WR-25030D	25	3	35	80	23.75	135	25	1	●

● Stock ○ Available upon Order

D	Tol
D ≤ 16	0 -0.05
D > 16	0 -0.06

Unit(mm)

Workpiece Material

P		M	K	N		
1234	5	123	123	123	4	5
Carbon Steel, Alloy Steel (<35HRC)	Alloy Steel, Tool Steel (<48HRC)	Stainless Steel	Cast Iron	Aluminium Alloys	Copper Alloys	Graphite
				☉		

☉ Most Suitable ○ Suitable

Recommended Cutting Data ※ P567

SA210-WR NEW

3 Flutes, Corner Radius, Long Neck

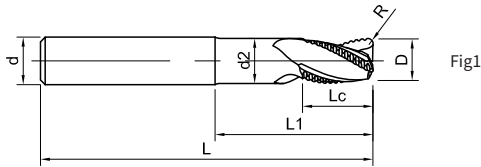

Please refer to page 167

» Continuation

Ordering Code	D	R	Lc	L1	d2	L	d	Figure No.	Stock
SA210-WR-25040	25	4	30	72	23.75	130	25	1	●
SA210-WR-25040A	25	4	37	52	23.75	110	25	1	●
SA210-WR-25040B	25	4	25	92	23.75	150	25	1	●
SA210-WR-25050	25	5	30	72	23.75	130	25	1	●

● Stock ○ Available upon Order

D	Tol
D ≤ 16	0 -0.05
D > 16	0 -0.06

Unit(mm)

Workpiece Material						
P		M	K	N		
1234	5	123	123	123	4	5
Carbon Steel, Alloy Steel (<35HRC)	Alloy Steel, Tool Steel (<48HRC)	Stainless Steel	Cast Iron	Aluminium Alloys	Copper Alloys	Graphite
				◎		

◎ Most Suitable ○ Suitable

Recommended Cutting Data ※ P567

SA210-WR-IC NEW

3 Flutes, Corner Radius, Long Neck Length (Inner Cooling with Coating)

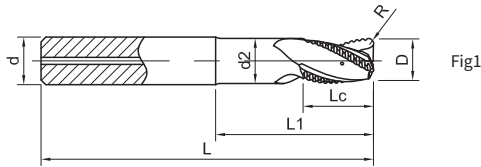

Fig1



Please refer to page 167

Ordering Code	D	R	Lc	L1	d2	L	d	Figure No.	Stock
SA210-WR-IC-12010	12	1	16	48	11.5	100	12	1	○
SA210-WR-IC-12020	12	2	16	48	11.5	100	12	1	○
SA210-WR-IC-12030	12	3	16	48	11.5	100	12	1	●
SA210-WR-IC-16010	16	1	20	65	15.2	115	16	1	○
SA210-WR-IC-16010A	16	1	24	42	15.2	92	16	1	○
SA210-WR-IC-16020	16	2	20	65	15.2	115	16	1	○
SA210-WR-IC-16020A	16	2	24	42	15.2	92	16	1	○
SA210-WR-IC-16030	16	3	20	65	15.2	115	16	1	●
SA210-WR-IC-16030A	16	3	24	42	15.2	92	16	1	●
SA210-WR-IC-20010	20	1	25	73	19	125	20	1	○
SA210-WR-IC-20010A	20	1	30	52	19	104	20	1	○
SA210-WR-IC-20020	20	2	25	73	19	125	20	1	○
SA210-WR-IC-20020A	20	2	30	52	19	104	20	1	○
SA210-WR-IC-20020B	20	2	20	88	19	140	20	1	○
SA210-WR-IC-20030	20	3	25	73	19	125	20	1	●

● Stock ○ Available upon Order

D	Tol
D≤16	0 -0.05
D>16	0 -0.06

Unit(mm)

Workpiece Material						
P		M	K	N		
1234	5	123	123	123	4	5
Carbon Steel, Alloy Steel (<35HRC)	Alloy Steel, Tool Steel (<48HRC)	Stainless Steel	Cast Iron	Aluminium Alloys	Copper Alloys	Graphite
				◎		

◎ Most Suitable ○ Suitable

Recommended Cutting Data ※ P567

SA210-WR-IC NEW

3 Flutes, Corner Radius, Long Neck Length (Inner Cooling with Coating)

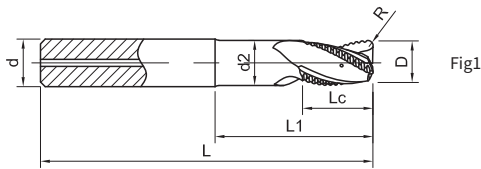

Please refer to page 167

» Continuation

Ordering Code	D	R	Lc	L1	d2	L	d	Figure No.	Stock
SA210-WR-IC-20030A	20	3	30	52	19	104	20	1	●
SA210-WR-IC-20030B	20	3	20	88	19	140	20	1	●
SA210-WR-IC-20040	20	4	25	73	19	125	20	1	○
SA210-WR-IC-20050	20	5	25	73	19	125	20	1	○
SA210-WR-IC-20050A	20	5	30	52	19	104	20	1	○
SA210-WR-IC-25010	25	1	30	72	23.75	130	25	1	○
SA210-WR-IC-25010B	25	1	25	92	23.75	150	25	1	○
SA210-WR-IC-25020	25	2	30	72	23.75	130	25	1	○
SA210-WR-IC-25020A	25	2	37	52	23.75	110	25	1	○
SA210-WR-IC-25020B	25	2	25	92	23.75	150	25	1	○
SA210-WR-IC-25030	25	3	30	72	23.75	130	25	1	●
SA210-WR-IC-25030A	25	3	37	52	23.75	110	25	1	●
SA210-WR-IC-25030B	25	3	25	92	23.75	150	25	1	●
SA210-WR-IC-25030C	25	3	35	100	23.75	150	25	1	●
SA210-WR-IC-25030D	25	3	35	80	23.75	135	25	1	●

● Stock ○ Available upon Order

D	Tol
D ≤ 16	0 -0.05
D > 16	0 -0.06

Unit(mm)

Workpiece Material						
P		M	K	N		
1234	5	123	123	123	4	5
Carbon Steel, Alloy Steel (<35HRC)	Alloy Steel, Tool Steel (<48HRC)	Stainless Steel	Cast Iron	Aluminium Alloys	Copper Alloys	Graphite
				⊙		

⊙ Most Suitable ○ Suitable

Recommended Cutting Data ※ P567

SA210-WR-IC NEW

3 Flutes, Corner Radius, Long Neck Length (Inner Cooling with Coating)

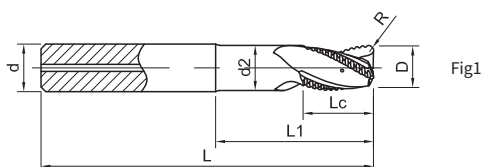

Please refer to page 167

» Continuation

Ordering Code	D	R	Lc	L1	d2	L	d	Figure No.	Stock
SA210-WR-IC-25040	25	4	30	72	23.75	130	25	1	○
SA210-WR-IC-25040A	25	4	37	52	23.75	110	25	1	○
SA210-WR-IC-25040B	25	4	25	92	23.75	150	25	1	○
SA210-WR-IC-25050	25	5	30	72	23.75	130	25	1	○

● Stock ○ Available upon Order

D	Tol
D ≤ 16	0 -0.05
D > 16	0 -0.06

Unit(mm)

Workpiece Material						
P		M	K	N		
1234	5	123	123	123	4	5
Carbon Steel, Alloy Steel (<35HRC)	Alloy Steel, Tool Steel (<48HRC)	Stainless Steel	Cast Iron	Aluminium Alloys	Copper Alloys	Graphite
				◎		

◎ Most Suitable ○ Suitable

Recommended Cutting Data ※ P567

SA210-NR

3 Flutes, Corner Radius

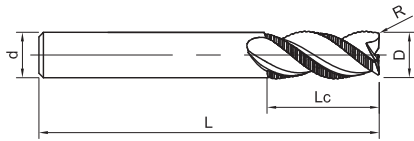
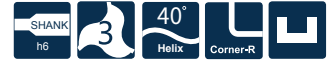

Fig1



Please refer to page 167

Ordering Code	D	Lc	R	L	d	Figure No.	Stock
SA210-NR-06001	6	16	0.1	50	6	2	●
SA210-NR-08002	8	20	0.2	60	8	2	●
SA210-NR-10003	10	25	0.25	75	10	2	●
SA210-NR-12003	12	30	0.25	75	12	2	●
SA210-NR-16003	16	36	0.3	100	16	2	●
SA210-NR-20003	20	45	0.3	100	20	2	●

● Stock ○ Available upon Order

D	Tol
D ≤ 6	0 -0.03
D > 6	0 -0.04

Unit (mm)

Workpiece Material						
P		M	K	N		
1234	5	123	123	123	4	5
Carbon Steel, Alloy Steel (<35HRC)	Alloy Steel, Tool Steel (<48HRC)	Stainless Steel	Cast Iron	Aluminium Alloys	Copper Alloys	Graphite
				○	○	

○ Most Suitable ○ Suitable

Recommended Cutting Data ※ P567

SA300-S3

3 Flutes, Square

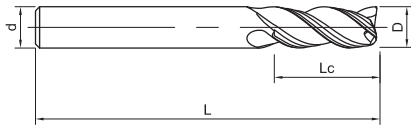

Fig1



Please refer to page 167

Ordering Code	D	Lc	L	d	Figure No.	Stock
SA300-S3-06016	6	16	50	6	1	●
SA300-S3-06016A	6	16	75	6	1	○
SA300-S3-08020	8	20	60	8	1	●
SA300-S3-08025	8	25	75	8	1	○
SA300-S3-10025	10	25	75	10	1	○
SA300-S3-12030	12	30	75	12	1	○
SA300-S3-16036	16	36	100	16	1	○
SA300-S3-20038	20	38	100	20	1	○

● Stock ○ Available upon Order

D	Tol
6 ≤ D ≤ 20	0 -0.03

Unit (mm)

Workpiece Material						
P		M	K	N		
1234	5	123	123	123	4	5
Carbon Steel, Alloy Steel (<35HRC)	Alloy Steel, Tool Steel (<48HRC)	Stainless Steel	Cast Iron	Aluminium Alloys	Copper Alloys	Graphite
				◎		

◎ Most Suitable ○ Suitable

Recommended Cutting Data ※ P568

SA300-RN2

2 Flutes, Corner Radius, Long Neck

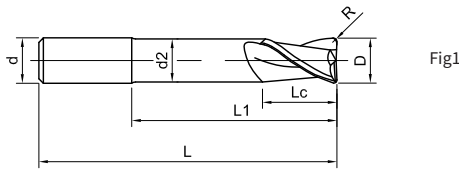

Please refer to page 167

Ordering Code	D	R	Lc	L1	d2	L	d	Figure No.	Stock
SA300-RN2-06002	6	0.2	10	20	5.5	60	6	1	●
SA300-RN2-06002A	6	0.2	10	40	5.5	80	6	1	●
SA300-RN2-06010	6	1	10	20	5.5	60	6	1	●
SA300-RN2-06010A	6	1	10	30	5.5	75	6	1	●
SA300-RN2-06010B	6	1	10	40	5.5	80	6	1	●
SA300-RN2-06020	6	2	10	20	5.5	60	6	1	●
SA300-RN2-06020A	6	2	10	40	5.5	80	6	1	●
SA300-RN2-08002	8	0.2	10	30	7.5	75	8	1	●
SA300-RN2-08002A	8	0.2	10	50	7.5	90	8	1	●
SA300-RN2-08010	8	1	10	30	7.5	75	8	1	●
SA300-RN2-08010A	8	1	10	40	7.5	80	8	1	●
SA300-RN2-08010B	8	1	10	50	7.5	90	8	1	○
SA300-RN2-08020	8	2	10	30	7.5	75	8	1	●
SA300-RN2-08020A	8	2	10	50	7.5	90	8	1	●
SA300-RN2-08030A	8	3	10	40	7.5	80	8	1	○
SA300-RN2-08030B	8	3	10	50	7.5	90	8	1	○
SA300-RN2-10002	10	0.2	12	30	9.5	75	10	1	●
SA300-RN2-10002A	10	0.2	12	50	9.5	90	10	1	●
SA300-RN2-10002B	10	0.2	12	40	9.5	80	10	1	○
SA300-RN2-10010A	10	1	12	30	9.5	75	10	1	●
SA300-RN2-10010B	10	1	12	40	9.5	80	10	1	●
SA300-RN2-10010C	10	1	12	50	9.5	90	10	1	●
SA300-RN2-10020	10	2	12	30	9.5	75	10	1	●

● Stock ○ Available upon Order

D	Tol
6 ≤ D ≤ 32	0 -0.03

Unit (mm)

Workpiece Material						
P		M	K	N		
1234	5	123	123	123	4	5
Carbon Steel, Alloy Steel (<35HRC)	Alloy Steel, Tool Steel (<48HRC)	Stainless Steel	Cast Iron	Aluminium Alloys	Copper Alloys	Graphite
				⊙		

⊙ Most Suitable ○ Suitable

Recommended Cutting Data ※ P568

SA300-RN2

2 Flutes, Corner Radius, Long Neck

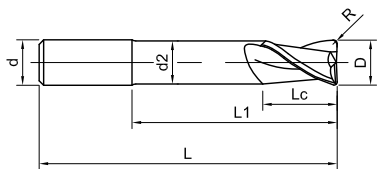

Fig1



Please refer to page 167

» Continuation

Ordering Code	D	R	Lc	L1	d2	L	d	Figure No.	Stock
SA300-RN2-10020A	10	2	12	50	9.5	90	10	1	●
SA300-RN2-10030	10	3	12	30	9.5	75	10	1	●
SA300-RN2-10030A	10	3	12	40	9.5	80	10	1	●
SA300-RN2-10030B	10	3	12	50	9.5	90	10	1	●
SA300-RN2-12002	12	0.2	14	50	11.5	100	12	1	●
SA300-RN2-12002A	12	0.2	14	70	11.5	120	12	1	●
SA300-RN2-12002C	12	0.2	14	60	11.5	110	12	1	○
SA300-RN2-12010	12	1	14	40	11.5	90	12	1	●
SA300-RN2-12010A	12	1	14	50	11.5	100	12	1	●
SA300-RN2-12010B	12	1	14	60	11.5	110	12	1	●
SA300-RN2-12010C	12	1	14	70	11.5	120	12	1	●
SA300-RN2-12020	12	2	14	50	11.5	100	12	1	●
SA300-RN2-12020A	12	2	14	70	11.5	120	12	1	●
SA300-RN2-12030	12	3	14	40	11.5	90	12	1	●
SA300-RN2-12030A	12	3	14	50	11.5	100	12	1	●
SA300-RN2-12030B	12	3	14	60	11.5	110	12	1	●
SA300-RN2-12030C	12	3	14	70	11.5	120	12	1	●
SA300-RN2-16002	16	0.2	18	50	15.5	100	16	1	●
SA300-RN2-16002A	16	0.2	18	70	15.5	120	16	1	●
SA300-RN2-16002C	16	0.2	18	60	15.5	110	16	1	○
SA300-RN2-16010	16	1	18	50	15.5	100	16	1	●
SA300-RN2-16010A	16	1	18	60	15.5	110	16	1	●

● Stock ○ Available upon Order

D	Tol
6 ≤ D ≤ 32	0 -0.03

Unit (mm)

Workpiece Material						
P		M	K	N		
1234	5	123	123	123	4	5
Carbon Steel, Alloy Steel (<35HRC)	Alloy Steel, Tool Steel (<48HRC)	Stainless Steel	Cast Iron	Aluminium Alloys	Copper Alloys	Graphite
				☉		

☉ Most Suitable ○ Suitable

Recommended Cutting Data ※ P568

SA300-RN2

2 Flutes, Corner Radius, Long Neck

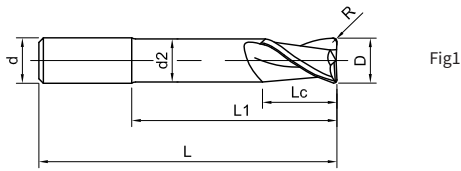

Please refer to page 167

» Continuation

Ordering Code	D	R	Lc	L1	d2	L	d	Figure No.	Stock
SA300-RN2-16010B	16	1	18	70	15.5	120	16	1	●
SA300-RN2-16010C	16	1	18	80	15.5	130	16	1	●
SA300-RN2-16020	16	2	18	60	15.5	110	16	1	●
SA300-RN2-16030	16	3	18	50	15.5	100	16	1	●
SA300-RN2-16030A	16	3	18	60	15.5	110	16	1	●
SA300-RN2-16030B	16	3	18	70	15.5	120	16	1	○
SA300-RN2-16030C	16	3	18	80	15.5	130	16	1	●
SA300-RN2-16040	16	4	18	60	15.5	110	16	1	○
SA300-RN2-16040B	16	4	18	70	15.5	120	16	1	○
SA300-RN2-16050	16	5	18	60	15.5	110	16	1	○
SA300-RN2-16050A	16	5	18	80	15.5	130	16	1	●
SA300-RN2-20002	20	0.2	24	60	19	110	20	1	●
SA300-RN2-20002A	20	0.2	24	80	19	130	20	1	●
SA300-RN2-20010	20	1	24	60	19	110	20	1	●
SA300-RN2-20010A	20	1	24	80	19	130	20	1	○
SA300-RN2-20010B	20	1	24	50	19	100	20	1	●
SA300-RN2-20010C	20	1	24	70	19	120	20	1	●
SA300-RN2-20010D	20	1	24	90	19	140	20	1	●
SA300-RN2-20010E	20	1	24	100	19	150	20	1	●
SA300-RN2-20020	20	2	24	60	19	110	20	1	●
SA300-RN2-20020A	20	2	24	50	19	100	20	1	○

● Stock ○ Available upon Order

D	Tol
6 ≤ D ≤ 32	0 -0.03

Unit (mm)

Workpiece Material						
P		M	K	N		
1234	5	123	123	123	4	5
Carbon Steel, Alloy Steel (<35HRC)	Alloy Steel, Tool Steel (<48HRC)	Stainless Steel	Cast Iron	Aluminium Alloys	Copper Alloys	Graphite
				⊙		

⊙ Most Suitable ○ Suitable

Recommended Cutting Data ※ P568

SA300-RN2

2 Flutes, Corner Radius, Long Neck

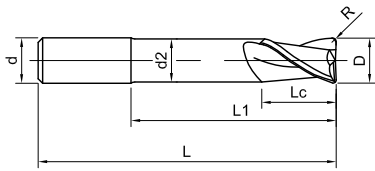

Fig1



Please refer to page 167

» Continuation

Ordering Code	D	R	Lc	L1	d2	L	d	Figure No.	Stock
SA300-RN2-20030	20	3	24	60	19	110	20	1	●
SA300-RN2-20030A	20	3	24	80	19	130	20	1	●
SA300-RN2-20030B	20	3	24	50	19	100	20	1	●
SA300-RN2-20030C	20	3	24	70	19	120	20	1	●
SA300-RN2-20030D	20	3	24	90	19	140	20	1	○
SA300-RN2-20030E	20	3	24	100	19	150	20	1	●
SA300-RN2-20040	20	4	24	60	19	110	20	1	○
SA300-RN2-20040C	20	4	24	80	19	130	20	1	○
SA300-RN2-20050	20	5	24	60	19	110	20	1	●
SA300-RN2-20050A	20	5	24	80	19	130	20	1	○
SA300-RN2-20050B	20	5	24	100	19	150	20	1	○
SA300-RN2-25010	25	1	30	80	24	135	25	1	●
SA300-RN2-25010A	25	1	30	100	24	155	25	1	○
SA300-RN2-25010B	25	1	30	125	24	180	25	1	●
SA300-RN2-25020	25	2	30	80	24	135	25	1	●
SA300-RN2-25030	25	3	30	80	24	135	25	1	●
SA300-RN2-25030A	25	3	30	100	24	155	25	1	○
SA300-RN2-25030B	25	3	30	125	24	180	25	1	○
SA300-RN2-32030	32	3	40	100	31	163	32	1	○
SA300-RN2-32030A	32	3	40	120	31	183	32	1	○

● Stock ○ Available upon Order

D	Tol
6 ≤ D ≤ 32	0 -0.03

Unit (mm)

Workpiece Material

P		M	K	N		
1234	5	123	123	123	4	5
Carbon Steel, Alloy Steel (<35HRC)	Alloy Steel, Tool Steel (<48HRC)	Stainless Steel	Cast Iron	Aluminium Alloys	Copper Alloys	Graphite
				◎		

◎ Most Suitable ○ Suitable

Recommended Cutting Data ※ P568

SA300-RN3

3 Flutes, Corner Radius, Long Neck

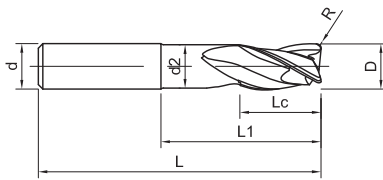

Fig1



Please refer to page 167

Ordering Code	D	R	Lc	L1	d2	L	d	Figure No.	Stock
SA300-RN3-06002	6	0.2	10	20	5.5	60	6	1	●
SA300-RN3-06002A	6	0.2	10	40	5.5	80	6	1	●
SA300-RN3-06010	6	1	10	20	5.5	60	6	1	●
SA300-RN3-06010A	6	1	10	30	5.5	75	6	1	●
SA300-RN3-06010B	6	1	10	40	5.5	80	6	1	●
SA300-RN3-06020	6	2	10	20	5.5	60	6	1	●
SA300-RN3-06020A	6	2	10	40	5.5	80	6	1	●
SA300-RN3-08002	8	0.2	10	30	7.5	75	8	1	●
SA300-RN3-08002A	8	0.2	10	50	7.5	90	8	1	●
SA300-RN3-08010	8	1	10	30	7.5	75	8	1	●
SA300-RN3-08010A	8	1	10	40	7.5	80	8	1	●
SA300-RN3-08010B	8	1	10	50	7.5	90	8	1	●
SA300-RN3-08020	8	2	10	30	7.5	75	8	1	●
SA300-RN3-08020A	8	2	10	50	7.5	90	8	1	●
SA300-RN3-10002	10	0.2	12	30	9.5	75	10	1	●
SA300-RN3-10002A	10	0.2	12	50	9.5	90	10	1	●
SA300-RN3-10010	10	1	12	30	9.5	75	10	1	●
SA300-RN3-10010A	10	1	12	40	9.5	80	10	1	●
SA300-RN3-10010B	10	1	12	50	9.5	90	10	1	●
SA300-RN3-10020	10	2	12	30	9.5	75	10	1	●

● Stock ○ Available upon Order

D	Tol
6 ≤ D ≤ 32	0 -0.03

Unit (mm)

Workpiece Material						
P		M	K	N		
1234	5	123	123	123	4	5
Carbon Steel, Alloy Steel (<35HRC)	Alloy Steel, Tool Steel (<48HRC)	Stainless Steel	Cast Iron	Aluminium Alloys	Copper Alloys	Graphite
				☉		

☉ Most Suitable ○ Suitable

Recommended Cutting Data ※ P568

SA300-RN3

3 Flutes, Corner Radius, Long Neck

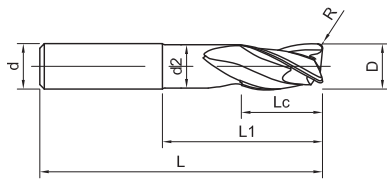

Fig1



Please refer to page 167

» Continuation

Ordering Code	D	R	Lc	L1	d2	L	d	Figure No.	Stock
SA300-RN3-10020A	10	2	12	50	9.5	90	10	1	●
SA300-RN3-10030	10	3	12	30	9.5	75	10	1	●
SA300-RN3-10030A	10	3	12	40	9.5	80	10	1	●
SA300-RN3-10030B	10	3	12	50	9.5	90	10	1	●
SA300-RN3-12002	12	0.2	14	50	11.5	100	12	1	●
SA300-RN3-12002A	12	0.2	14	70	11.5	120	12	1	●
SA300-RN3-12010	12	1	14	40	11.5	90	12	1	●
SA300-RN3-12010A	12	1	14	50	11.5	100	12	1	●
SA300-RN3-12010B	12	1	14	60	11.5	110	12	1	●
SA300-RN3-12010C	12	1	14	70	11.5	120	12	1	●
SA300-RN3-12020	12	2	14	50	11.5	100	12	1	●
SA300-RN3-12020A	12	2	14	70	11.5	120	12	1	●
SA300-RN3-12030	12	3	14	40	11.5	90	12	1	●
SA300-RN3-12030A	12	3	14	50	11.5	100	12	1	●
SA300-RN3-12030B	12	3	14	60	11.5	110	12	1	●
SA300-RN3-12030C	12	3	14	70	11.5	120	12	1	●
SA300-RN3-16002	16	0.2	18	50	15.5	100	16	1	●
SA300-RN3-16002A	16	0.2	18	70	15.5	120	16	1	●
SA300-RN3-16010	16	1	18	50	15.5	100	16	1	●
SA300-RN3-16010A	16	1	18	60	15.5	110	16	1	●

● Stock ○ Available upon Order

D	Tol
6 ≤ D ≤ 32	0 -0.03

Unit (mm)

Workpiece Material

P		M	K	N		
1234	5	123	123	123	4	5
Carbon Steel, Alloy Steel (<35HRC)	Alloy Steel, Tool Steel (<48HRC)	Stainless Steel	Cast Iron	Aluminium Alloys	Copper Alloys	Graphite
				☉		

☉ Most Suitable ○ Suitable

Recommended Cutting Data ※ P568

SA300-RN3

3 Flutes, Corner Radius, Long Neck

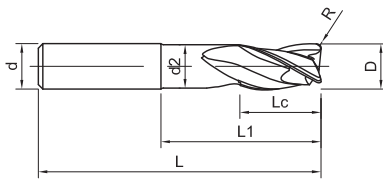

Fig1



Please refer to page 167

» Continuation

Ordering Code	D	R	Lc	L1	d2	L	d	Figure No.	Stock
SA300-RN3-16010B	16	1	18	70	15.5	120	16	1	●
SA300-RN3-16010C	16	1	18	80	15.5	130	16	1	●
SA300-RN3-16020	16	2	18	60	15.5	110	16	1	●
SA300-RN3-16030	16	3	18	50	15.5	100	16	1	●
SA300-RN3-16030A	16	3	18	60	15.5	110	16	1	●
SA300-RN3-16030B	16	3	18	70	15.5	120	16	1	●
SA300-RN3-16030C	16	3	18	80	15.5	130	16	1	●
SA300-RN3-16040	16	4	18	60	15.5	110	16	1	●
SA300-RN3-16050	16	5	18	60	15.5	110	16	1	●
SA300-RN3-16050A	16	5	18	80	15.5	130	16	1	●
SA300-RN3-20002	20	0.2	24	60	19	110	20	1	●
SA300-RN3-20002A	20	0.2	24	80	19	130	20	1	●
SA300-RN3-20010	20	1	24	60	19	110	20	1	●
SA300-RN3-20010A	20	1	24	80	19	130	20	1	●
SA300-RN3-20010B	20	1	24	50	19	100	20	1	●
SA300-RN3-20010C	20	1	24	70	19	120	20	1	●
SA300-RN3-20010D	20	1	24	90	19	140	20	1	●
SA300-RN3-20010E	20	1	24	100	19	150	20	1	●
SA300-RN3-20020	20	2	24	60	19	110	20	1	●
SA300-RN3-20030	20	3	24	60	19	110	20	1	●

● Stock ○ Available upon Order

D	Tol
6 ≤ D ≤ 32	0 -0.03

Unit (mm)

Workpiece Material

P		M	K	N		
1234	5	123	123	123	4	5
Carbon Steel, Alloy Steel (<35HRC)	Alloy Steel, Tool Steel (<48HRC)	Stainless Steel	Cast Iron	Aluminium Alloys	Copper Alloys	Graphite
				☉		

☉ Most Suitable ○ Suitable

Recommended Cutting Data ※ P568

SA300-RN3

3 Flutes, Corner Radius, Long Neck

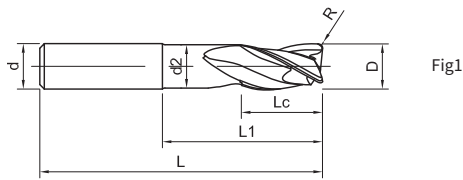

Please refer to page 167

» Continuation

Ordering Code	D	R	Lc	L1	d2	L	d	Figure No.	Stock
SA300-RN3-20030A	20	3	24	80	19	130	20	1	●
SA300-RN3-20030B	20	3	24	50	19	100	20	1	●
SA300-RN3-20030C	20	3	24	70	19	120	20	1	●
SA300-RN3-20030D	20	3	24	90	19	140	20	1	○
SA300-RN3-20030E	20	3	24	100	19	150	20	1	●
SA300-RN3-20040	20	4	24	60	19	110	20	1	●
SA300-RN3-20050	20	5	24	60	19	110	20	1	●
SA300-RN3-20050A	20	5	24	80	19	130	20	1	●
SA300-RN3-20050B	20	5	24	100	19	150	20	1	●
SA300-RN3-25010	25	1	30	80	24	135	25	1	●
SA300-RN3-25010A	25	1	30	100	24	155	25	1	○
SA300-RN3-25010B	25	1	30	125	24	180	25	1	●
SA300-RN3-25020	25	2	30	80	24	135	25	1	●
SA300-RN3-25030	25	3	30	80	24	135	25	1	●
SA300-RN3-25030A	25	3	30	100	24	155	25	1	○
SA300-RN3-25030B	25	3	30	125	24	180	25	1	○
SA300-RN3-32030	32	3	40	100	31	163	32	1	○
SA300-RN3-32030A	32	3	40	120	31	183	32	1	○

● Stock ○ Available upon Order

D	Tol
6 ≤ D ≤ 32	0 -0.03

Unit (mm)

Workpiece Material

P		M	K	N		
1234	5	123	123	123	4	5
Carbon Steel, Alloy Steel (<35HRC)	Alloy Steel, Tool Steel (<48HRC)	Stainless Steel	Cast Iron	Aluminium Alloys	Copper Alloys	Graphite
				◎		

◎ Most Suitable ○ Suitable

Recommended Cutting Data ※ P568

SA300-BN2

2 Flutes, Ballnose

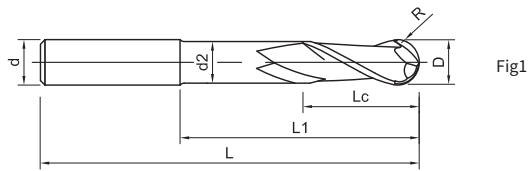

Fig1



Please refer to page 167

Ordering Code	D	R	Lc	L1	d2	L	d	Figure No.	Stock
SA300-BN2-06020	6	3	10	20	5.5	60	6	1	○
SA300-BN2-06030	6	3	10	30	5.5	75	6	1	●
SA300-BN2-06040	6	3	10	40	5.5	80	6	1	○
SA300-BN2-08030	8	4	10	30	7.5	75	8	1	○
SA300-BN2-08040	8	4	10	40	7.5	80	8	1	●
SA300-BN2-08050	8	4	10	50	7.5	90	8	1	○
SA300-BN2-10030	10	5	12	30	9.5	75	10	1	○
SA300-BN2-10040	10	5	12	40	9.5	80	10	1	●
SA300-BN2-12040	12	6	14	40	11.5	90	12	1	○
SA300-BN2-12050	12	6	14	50	11.5	100	12	1	○
SA300-BN2-12060	12	6	14	60	11.5	110	12	1	○
SA300-BN2-16060	16	8	18	60	15.5	110	16	1	○
SA300-BN2-16070	16	8	18	70	15.5	120	16	1	●
SA300-BN2-20060	20	10	24	60	19	110	20	1	○
SA300-BN2-20080	20	10	24	80	19	130	20	1	●

● Stock ○ Available upon Order

D	Tol
6 ≤ D ≤ 20	0 -0.03

Unit (mm)

Workpiece Material

P		M	K	N		
1234	5	123	123	123	4	5
Carbon Steel, Alloy Steel (<35HRC)	Alloy Steel, Tool Steel (<48HRC)	Stainless Steel	Cast Iron	Aluminium Alloys	Copper Alloys	Graphite
				○		

○ Most Suitable ○ Suitable

Recommended Cutting Data ※ P568

SA300-SF-SN4 NEW

4 Flutes, with Long Neck, Square

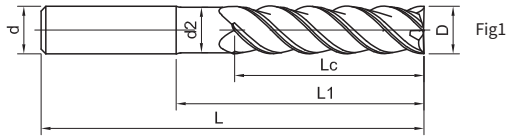

Please refer to page 167

Ordering Code	D	Lc	L1	d2	L	d	Figure No.	Stock
SA300-SF-SN4-06030	6	24	30	5.5	60	6	1	●
SA300-SF-SN4-08040	8	32	40	7.5	64	8	1	●
SA300-SF-SN4-10050	10	40	50	9.5	80	10	1	●
SA300-SF-SN4-12040	12	30	40	11.5	83	12	1	●
SA300-SF-SN4-12062	12	48	62	11.5	100	12	1	●
SA300-SF-SN4-16051	16	40	51	15.5	93	16	1	●
SA300-SF-SN4-16082	16	64	82	15.5	125	16	1	●
SA300-SF-SN4-20063	20	50	63	19	108	20	1	●
SA300-SF-SN4-200A2	20	80	102	19	150	20	1	●

● Stock ○ Available upon Order

D	Tol
6 ≤ D ≤ 20	-0.02 -0.04

Unit (mm)

Workpiece Material						
P		M	K	N		
1234	5	123	123	123	4	5
Carbon Steel, Alloy Steel (<35HRC)	Alloy Steel, Tool Steel (<48HRC)	Stainless Steel	Cast Iron	Aluminium Alloys	Copper Alloys	Graphite
				⊙		

⊙ Most Suitable ○ Suitable

Recommended Cutting Data ※ P569

SA300-SF-IC-SN4 NEW

4 Flutes, with Long Neck, Square (Internal Cooling with Coating)

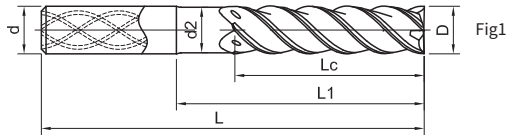

Please refer to page 167

Ordering Code	D	Lc	L1	d2	L	d	Figure No.	Stock
SA300-SF-IC-SN4-12040	12	30	40	11.5	83	12	1	○
SA300-SF-IC-SN4-12062	12	48	62	11.5	100	12	1	○
SA300-SF-IC-SN4-16051	16	40	51	15.5	93	16	1	○
SA300-SF-IC-SN4-16082	16	64	82	15.5	125	16	1	○
SA300-SF-IC-SN4-20063	20	50	63	19	108	20	1	○
SA300-SF-IC-SN4-200A2	20	80	102	19	150	20	1	○

● Stock ○ Available upon Order

D	Tol
6 ≤ D ≤ 20	-0.02 -0.04

Unit(mm)

Workpiece Material						
P		M	K	N		
1234	5	123	123	123	4	5
Carbon Steel, Alloy Steel (<35HRC)	Alloy Steel, Tool Steel (<48HRC)	Stainless Steel	Cast Iron	Aluminium Alloys	Copper Alloys	Graphite
				◎		

◎ Most Suitable ○ Suitable

Recommended Cutting Data ※ P569

SA300-SF-RN4 NEW

4 Flutes, Corner Radius, Long Neck

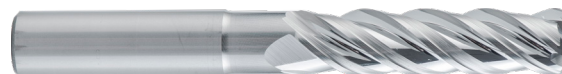
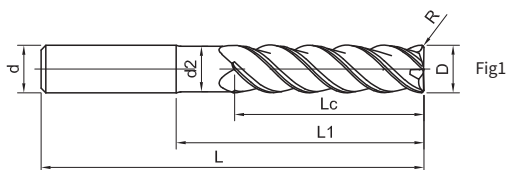

Please refer to page 167

Ordering Code	D	R	Lc	L1	d2	L	d	Figure No.	Stock
SA300-SF-RN4-10030	10	3	40	50	9.5	80	10	1	●
SA300-SF-RN4-12005	12	0.5	30	40	11.5	83	12	1	●
SA300-SF-RN4-12005A	12	0.5	48	62	11.5	100	12	1	●
SA300-SF-RN4-12020	12	2	30	40	11.5	83	12	1	●
SA300-SF-RN4-12020A	12	2	48	62	11.5	100	12	1	●
SA300-SF-RN4-12030	12	3	30	40	11.5	83	12	1	●
SA300-SF-RN4-12030A	12	3	48	62	11.5	100	12	1	●
SA300-SF-RN4-12040	12	4	30	40	11.5	83	12	1	●
SA300-SF-RN4-12040A	12	4	48	62	11.5	100	12	1	●
SA300-SF-RN4-12050	12	5	30	40	11.5	83	12	1	●
SA300-SF-RN4-16020	16	2	40	51	15.5	93	16	1	●
SA300-SF-RN4-16020A	16	2	64	82	15.5	125	16	1	●
SA300-SF-RN4-16030	16	3	40	51	15.5	93	16	1	●
SA300-SF-RN4-16030A	16	3	64	82	15.5	125	16	1	●
SA300-SF-RN4-16040	16	4	40	51	15.5	93	16	1	●
SA300-SF-RN4-16040A	16	4	64	82	15.5	125	16	1	●
SA300-SF-RN4-16050	16	5	40	51	15.5	93	16	1	●

● Stock ○ Available upon Order

D	Tol
6 ≤ D ≤ 20	-0.02 -0.04

Unit(mm)

Workpiece Material						
P		M	K	N		
1234	5	123	123	123	4	5
Carbon Steel, Alloy Steel (<35HRC)	Alloy Steel, Tool Steel (<48HRC)	Stainless Steel	Cast Iron	Aluminium Alloys	Copper Alloys	Graphite
				☉		

☉ Most Suitable ○ Suitable

Recommended Cutting Data ※ P569

SA300-SF-RN4 NEW

4 Flutes, Corner Radius, Long Neck

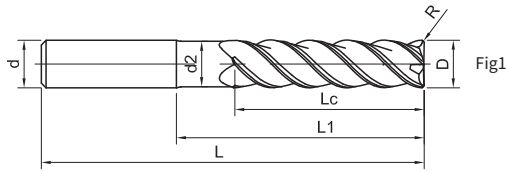

Please refer to page 167

» Continuation

Ordering Code	D	R	Lc	L1	d2	L	d	Figure No.	Stock
SA300-SF-RN4-20030	20	3	50	63	19	108	20	1	●
SA300-SF-RN4-20030A	20	3	80	102	19	150	20	1	●
SA300-SF-RN4-20040	20	4	50	63	19	108	20	1	●
SA300-SF-RN4-20040A	20	4	80	102	19	150	20	1	●
SA300-SF-RN4-20050	20	5	50	63	19	108	20	1	●
SA300-SF-RN4-20050A	20	5	80	102	19	150	20	1	●

● Stock ○ Available upon Order

D	Tol
6 ≤ D ≤ 20	-0.02 -0.04

Unit(mm)

Workpiece Material						
P		M	K	N		
1234	5	123	123	123	4	5
Carbon Steel, Alloy Steel (<35HRC)	Alloy Steel, Tool Steel (<48HRC)	Stainless Steel	Cast Iron	Aluminium Alloys	Copper Alloys	Graphite
				⊙		

⊙ Most Suitable ○ Suitable

Recommended Cutting Data ※ P569

SA300-SF-IC-RN4 NEW

4 Flutes, Corner Radius, Long Neck (Inner Cooling with Coating)

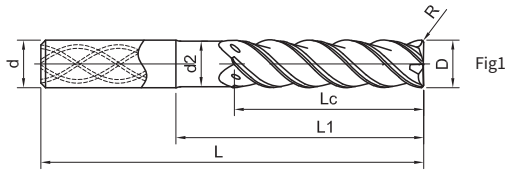

Please refer to page 167

Ordering Code	D	R	Lc	L1	d2	L	d	Figure No.	Stock
SA300-SF-IC-RN4-12005	12	0.5	30	40	11.5	83	12	1	○
SA300-SF-IC-RN4-12020	12	2	30	40	11.5	83	12	1	○
SA300-SF-IC-RN4-12020A	12	2	48	62	11.5	100	12	1	○
SA300-SF-IC-RN4-12030	12	3	30	40	11.5	83	12	1	●
SA300-SF-IC-RN4-12030A	12	3	48	62	11.5	100	12	1	●
SA300-SF-IC-RN4-12040	12	4	30	40	11.5	83	12	1	○
SA300-SF-IC-RN4-12040A	12	4	48	62	11.5	100	12	1	○
SA300-SF-IC-RN4-12050	12	5	30	40	11.5	83	12	1	○
SA300-SF-IC-RN4-16020	16	2	40	51	15.5	93	16	1	○
SA300-SF-IC-RN4-16020A	16	2	64	82	15.5	125	16	1	○
SA300-SF-IC-RN4-16030	16	3	40	51	15.5	93	16	1	●
SA300-SF-IC-RN4-16030A	16	3	64	82	15.5	125	16	1	●
SA300-SF-IC-RN4-16040	16	4	40	51	15.5	93	16	1	○
SA300-SF-IC-RN4-16040A	16	4	64	82	15.5	125	16	1	○
SA300-SF-IC-RN4-16050	16	5	40	51	15.5	93	16	1	○

● Stock ○ Available upon Order

D	Tol
6 ≤ D ≤ 20	-0.02 -0.04

Unit(mm)

Workpiece Material						
P		M	K	N		
1234	5	123	123	123	4	5
Carbon Steel, Alloy Steel (<35HRC)	Alloy Steel, Tool Steel (<48HRC)	Stainless Steel	Cast Iron	Aluminium Alloys	Copper Alloys	Graphite
				◎		

◎ Most Suitable ○ Suitable

Recommended Cutting Data ※ P569

SA300-SF-IC-RN4 NEW

4 Flutes, Corner Radius, Long Neck (Internal Cooling with Coating)

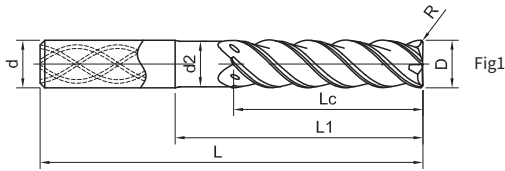

Please refer to page 167

» Continuation

Ordering Code	D	R	Lc	L1	d2	L	d	Figure No.	Stock
SA300-SF-IC-RN4-20030	20	3	50	63	19	108	20	1	●
SA300-SF-IC-RN4-20030A	20	3	80	102	19	150	20	1	●
SA300-SF-IC-RN4-20040	20	4	50	63	19	108	20	1	○
SA300-SF-IC-RN4-20040A	20	4	80	102	19	150	20	1	○
SA300-SF-IC-RN4-20050	20	5	50	63	19	108	20	1	○
SA300-SF-IC-RN4-20050A	20	5	80	102	19	150	20	1	○

● Stock ○ Available upon Order

D	Tol
6 ≤ D ≤ 20	-0.02 -0.04

Unit(mm)

Workpiece Material						
P		M	K	N		
1234	5	123	123	123	4	5
Carbon Steel, Alloy Steel (<35HRC)	Alloy Steel, Tool Steel (<48HRC)	Stainless Steel	Cast Iron	Aluminium Alloys	Copper Alloys	Graphite
				⊙		

⊙ Most Suitable ○ Suitable

Recommended Cutting Data ※ P569

SA300-WF-RN6 NEW

6 Flutes, Corner Radius, Long Neck

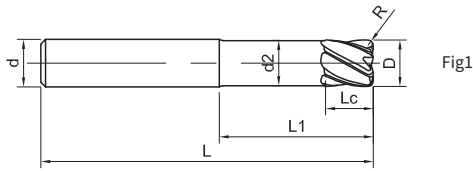

Please refer to page 167

Ordering Code	D	R	Lc	L1	d2	L	d	Figure No.	Stock
SA300-WF-RN6-16030	16	3	16	42	15.5	92	16	1	●
SA300-WF-RN6-16030A	16	3	16	65	15.5	115	16	1	●
SA300-WF-RN6-16040	16	4	16	65	15.5	115	16	1	●
SA300-WF-RN6-20030	20	3	20	52	19	104	20	1	●
SA300-WF-RN6-20030A	20	3	20	73	19	125	20	1	●
SA300-WF-RN6-20040	20	4	20	73	19	125	20	1	●
SA300-WF-RN6-25030	25	3	25	52	24	110	25	1	●
SA300-WF-RN6-25030A	25	3	25	72	24	130	25	1	●
SA300-WF-RN6-25030B	25	3	25	92	24	150	25	1	●
SA300-WF-RN6-25040	25	4	25	72	24	130	25	1	●

● Stock ○ Available upon Order

D	Tol
16 ≤ D ≤ 25	-0.02 -0.05

Unit(mm)

Workpiece Material						
P		M	K	N		
1234	5	123	123	123	4	5
Carbon Steel, Alloy Steel (<35HRC)	Alloy Steel, Tool Steel (<48HRC)	Stainless Steel	Cast Iron	Aluminium Alloys	Copper Alloys	Graphite
				⊙		

⊙ Most Suitable ○ Suitable

Recommended Cutting Data ※ P569

SA300-WF-IC-RN6 NEW

6 Flutes, Corner Radius, Long Neck (Internal Cooling with Coating)

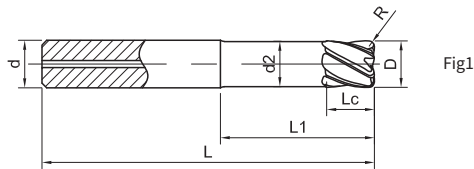

Please refer to page 167

Ordering Code	D	R	Lc	L1	d2	L	d	Figure No.	Stock
SA300-WF-IC-RN6-16030	16	3	16	42	15.5	92	16	1	○
SA300-WF-IC-RN6-16030A	16	3	16	65	15.5	115	16	1	●
SA300-WF-IC-RN6-16040	16	4	16	65	15.5	115	16	1	○
SA300-WF-IC-RN6-20030	20	3	20	52	19	104	20	1	●
SA300-WF-IC-RN6-20030A	20	3	20	73	19	125	20	1	●
SA300-WF-IC-RN6-20040	20	4	20	73	19	125	20	1	○
SA300-WF-IC-RN6-25030	25	3	25	52	24	110	25	1	●
SA300-WF-IC-RN6-25030A	25	3	25	72	24	130	25	1	●
SA300-WF-IC-RN6-25030B	25	3	25	92	24	150	25	1	●
SA300-WF-IC-RN6-25040	25	4	25	72	24	130	25	1	○

● Stock ○ Available upon Order

D	Tol
16 < D ≤ 25	-0.02 -0.05

Unit(mm)

Workpiece Material						
P		M	K	N		
1234	5	123	123	123	4	5
Carbon Steel, Alloy Steel (<35HRC)	Alloy Steel, Tool Steel (<48HRC)	Stainless Steel	Cast Iron	Aluminium Alloys	Copper Alloys	Graphite
				⊙		

⊙ Most Suitable ○ Suitable

Recommended Cutting Data ※ P569

DNM100-RS1

1 Flute, Corner Radius

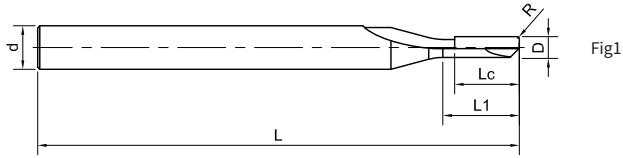

Fig1



Please refer to page 167

Ordering Code	D	Lc	R	L1	L	d	Figure No.	Stock
DNM100-RS1-02001	2	6	0.1	8	50	4	1	●
DNM100-RS1-02002	2	6	0.2	8	50	4	1	●
DNM100-RS1-02003	2	6	0.3	8	50	4	1	○
DNM100-RS1-03001	3	6	0.1	8	50	4	1	●
DNM100-RS1-03002	3	6	0.2	8	50	4	1	●
DNM100-RS1-03003	3	6	0.3	8	50	4	1	○

● Stock ○ Available upon Order

D	Tol
D ≤ 3	±0.02

Unit (mm)

Workpiece Material						
P		M	K	N		
1234	5	123	123	123	4	5
Carbon Steel, Alloy Steel (<35HRC)	Alloy Steel, Tool Steel (<48HRC)	Stainless Steel	Cast Iron	Aluminium Alloys	Copper Alloys	Graphite
				◎	◎	◎

◎ Most Suitable ○ Suitable

Recommended Cutting Data ※ P569

DNM100-RS2

2 Flute, Corner Radius

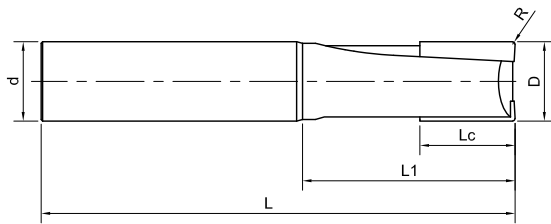

Fig1



Please refer to page 167

Ordering Code	D	Lc	R	L1	L	d	Figure No.	Stock
DNM100-RS2-04001	4	6	0.1	8	50	6	1	●
DNM100-RS2-04002	4	6	0.2	8	50	6	1	●
DNM100-RS2-04005	4	6	0.5	8	50	6	1	○
DNM100-RS2-06001	6	10	0.1	20	75	6	1	●
DNM100-RS2-06002	6	10	0.2	20	75	6	1	●
DNM100-RS2-06003	6	10	0.3	20	75	6	1	○
DNM100-RS2-06005	6	10	0.5	20	75	6	1	○
DNM100-RS2-08001	8	15	0.1	30	75	10	1	●
DNM100-RS2-08002	8	15	0.2	30	75	10	1	○
DNM100-RS2-08005	8	15	0.5	30	75	10	1	●
DNM100-RS2-08010	8	15	1	30	75	10	1	●
DNM100-RS2-10001	10	15	0.1	35	75	10	1	○
DNM100-RS2-10002	10	15	0.2	35	75	10	1	●
DNM100-RS2-10005	10	15	0.5	35	75	10	1	●
DNM100-RS2-10010	10	15	1	35	75	10	1	●
DNM100-RS2-10020	10	15	2	35	75	10	1	○

● Stock ○ Available upon Order

D	Tol
D ≤ 20	±0.02

Unit (mm)

Workpiece Material						
P		M	K	N		
1234	5	123	123	123	4	5
Carbon Steel, Alloy Steel (<35HRC)	Alloy Steel, Tool Steel (<48HRC)	Stainless Steel	Cast Iron	Aluminium Alloys	Copper Alloys	Graphite
				⊙	⊙	⊙

⊙ Most Suitable ○ Suitable

Recommended Cutting Data ※ P569

DNM100-RS3

3 Flutes, Corner Radius

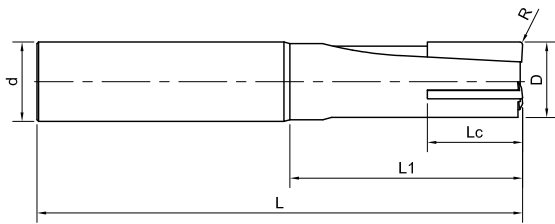

Fig1



Please refer to page 167

Ordering Code	D	Lc	R	L1	L	d	Figure No.	Stock
DNM100-RS3-10001	10	15	0.1	35	75	10	1	●
DNM100-RS3-10002	10	15	0.2	35	75	10	1	●
DNM100-RS3-10005	10	15	0.5	35	75	10	1	●
DNM100-RS3-10010	10	15	1	35	75	10	1	○
DNM100-RS3-10020	10	15	2	35	75	10	1	○
DNM100-RS3-12002	12	15	0.2	40	75	12	1	●
DNM100-RS3-12005	12	15	0.5	40	75	12	1	●
DNM100-RS3-12010	12	15	1	40	75	12	1	●
DNM100-RS3-12020	12	15	2	40	75	12	1	○
DNM100-RS3-16002	16	15	0.2	45	100	16	1	●
DNM100-RS3-16005	16	15	0.5	45	100	16	1	●
DNM100-RS3-16010	16	15	1	45	100	16	1	●
DNM100-RS3-16020	16	15	2	45	100	16	1	○
DNM100-RS3-16030	16	15	3	45	100	16	1	○

● Stock ○ Available upon Order

D	Tol
D ≤ 20	±0.02

Unit (mm)

Workpiece Material						
P		M	K	N		
1234	5	123	123	123	4	5
Carbon Steel, Alloy Steel (<35HRC)	Alloy Steel, Tool Steel (<48HRC)	Stainless Steel	Cast Iron	Aluminium Alloys	Copper Alloys	Graphite
				◎	◎	◎

◎ Most Suitable ○ Suitable

Recommended Cutting Data ※ P569

SG200-S2

2 Flutes, Standard Length, Square

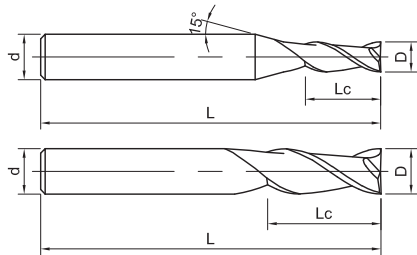
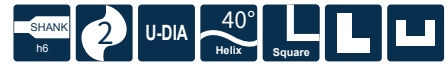

Fig1

Fig2



Please refer to page 167

Ordering Code	D	Lc	L	d	Figure No.	Stock
SG200-S2-00401	0.4	0.8	50	4	1	○
SG200-S2-00802	0.8	2	50	4	1	○
SG200-S2-01003	1	3	50	4	1	●
SG200-S2-01504	1.5	4	50	4	1	●
SG200-S2-02006	2	6	50	4	1	●
SG200-S2-02008	2	8	75	4	1	●
SG200-S2-03009	3	9	50	4	1	●
SG200-S2-03012	3	12	75	4	1	●
SG200-S2-63009	3	9	50	6	1	○
SG200-S2-04011	4	11	50	4	2	●
SG200-S2-04016	4	16	75	4	2	○
SG200-S2-64011	4	11	50	6	1	○
SG200-S2-05013	5	13	50	6	1	●
SG200-S2-05020	5	20	100	6	1	○
SG200-S2-06016	6	16	50	6	2	●
SG200-S2-06025	6	25	100	6	2	○
SG200-S2-08020	8	20	60	8	2	●
SG200-S2-10025	10	25	75	10	2	●
SG200-S2-12030	12	30	75	12	2	●

● Stock ○ Available upon Order

D	Tol
D < 6	0 -0.02
6 ≤ D ≤ 12	0 -0.03

Unit (mm)

Workpiece Material						
P		M	K	N		
1234	5	123	123	123	4	5
Carbon Steel, Alloy Steel (<35HRC)	Alloy Steel, Tool Steel (<48HRC)	Stainless Steel	Cast Iron	Aluminium Alloys	Copper Alloys	Graphite
				○	○	◎

◎ Most Suitable ○ Suitable

Recommended Cutting Data ※ P570

SG200-SN2

2 Flutes, Long Neck, Square

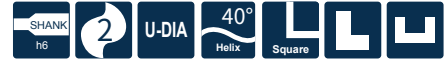
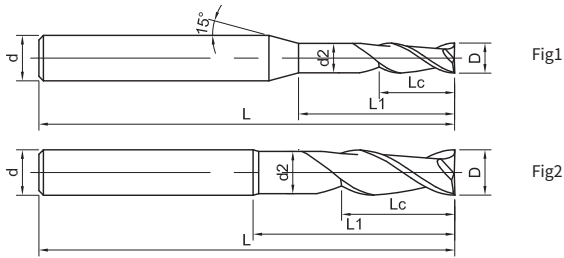

Please refer to page 167

Ordering Code	D	Lc	d2	L1	L	d	Figure No.	Stock
SG200-SN2-01005	1	3	0.95	5	50	4	1	●
SG200-SN2-01006	1	3	0.96	6	50	4	2	●
SG200-SN2-01020	1	3	0.95	20	60	4	1	●
SG200-SN2-01510	1.5	6	1.44	10	50	4	1	●
SG200-SN2-01520	1.5	6	1.44	20	60	4	1	●
SG200-SN2-02015	2	8	1.92	15	50	4	1	●
SG200-SN2-02020	2	8	1.92	20	50	4	1	○
SG200-SN2-02030	2	8	1.92	30	75	4	1	●
SG200-SN2-03015	3	12	2.9	15	50	4	1	●
SG200-SN2-03030	3	12	2.9	30	75	4	1	●
SG200-SN2-04020	4	16	3.9	20	50	4	2	●
SG200-SN2-04025	4	16	3.9	25	75	4	2	●
SG200-SN2-04040	4	16	3.9	40	75	4	2	●
SG200-SN2-05030	5	20	4.9	30	75	6	1	●
SG200-SN2-06030	6	24	5.9	30	75	6	2	●
SG200-SN2-06040	6	24	5.9	40	75	6	2	●
SG200-SN2-08040	8	25	7.9	40	100	8	2	○
SG200-SN2-10040	10	25	9.8	40	100	10	2	○
SG200-SN2-12040	12	25	11.8	40	100	12	2	●
SG200-SN2-12060	12	25	11.8	60	100	12	2	○

● Stock ○ Available upon Order

D	Tol
D < 6	0 -0.02
6 ≤ D ≤ 12	0 -0.03

Unit (mm)

Workpiece Material

P		M	K	N		
1234	5	123	123	123	4	5
Carbon Steel, Alloy Steel (<35HRC)	Alloy Steel, Tool Steel (<48HRC)	Stainless Steel	Cast Iron	Aluminium Alloys	Copper Alloys	Graphite
				○	○	◎

◎ Most Suitable ○ Suitable

Recommended Cutting Data ※ P570

SG200-S3

3 Flutes, Standard Length, Square

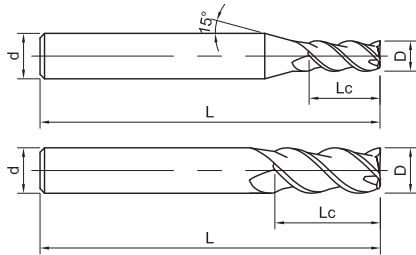
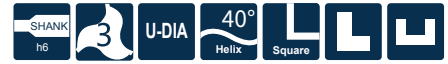

Fig1

Fig2



Please refer to page 167

Ordering Code	D	Lc	L	d	Figure No.	Stock
SG200-S3-01003	1	3	50	4	1	○
SG200-S3-01504	1.5	4	50	4	1	●
SG200-S3-01506	1.5	6	60	4	1	○
SG200-S3-02006	2	6	50	4	1	●
SG200-S3-02010	2	10	60	4	1	●
SG200-S3-03009	3	9	50	4	1	●
SG200-S3-03015	3	15	60	4	1	●
SG200-S3-63009	3	9	50	6	1	○
SG200-S3-04011	4	11	50	4	2	●
SG200-S3-04020	4	20	75	4	2	○
SG200-S3-64011	4	11	50	6	1	●
SG200-S3-05013	5	13	50	6	1	●
SG200-S3-06016	6	16	50	6	2	●
SG200-S3-06018	6	18	75	6	2	●
SG200-S3-06025	6	25	100	6	2	●
SG200-S3-08020	8	20	60	8	2	●
SG200-S3-08035	8	35	100	8	2	●
SG200-S3-10025	10	25	75	10	2	●
SG200-S3-10040	10	40	100	10	2	●
SG200-S3-12030	12	30	75	12	2	○

● Stock ○ Available upon Order

D	Tol
D < 6	0 -0.02
6 ≤ D ≤ 12	0 -0.03

Unit (mm)

Workpiece Material						
P		M	K	N		
1234	5	123	123	123	4	5
Carbon Steel, Alloy Steel (<35HRC)	Alloy Steel, Tool Steel (<48HRC)	Stainless Steel	Cast Iron	Aluminium Alloys	Copper Alloys	Graphite
				○	○	◎

◎ Most Suitable ○ Suitable

Recommended Cutting Data ※ P570

SG200-S4

4 Flutes, Standard Length, Square

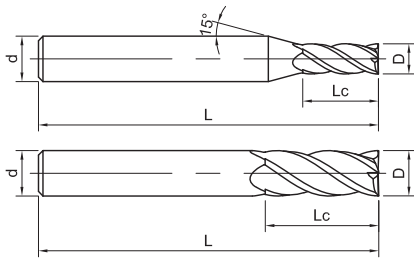

Fig1

Fig2



Please refer to page 167

Ordering Code	D	Lc	L	d	Figure No.	Stock
SG200-S4-02006	2	6	50	4	1	●
SG200-S4-02010	2	10	60	4	1	●
SG200-S4-03009	3	9	50	4	1	●
SG200-S4-03015	3	15	60	4	1	●
SG200-S4-63009	3	9	50	6	1	○
SG200-S4-04011	4	11	50	4	2	●
SG200-S4-04020	4	20	75	4	2	●
SG200-S4-64011	4	11	50	6	1	●
SG200-S4-05013	5	13	50	6	1	●
SG200-S4-06016	6	16	50	6	2	●
SG200-S4-06025	6	25	100	6	2	●
SG200-S4-08020	8	20	60	8	2	●
SG200-S4-08025	8	25	100	8	2	●
SG200-S4-10025	10	25	75	10	2	●
SG200-S4-10040	10	40	100	10	2	●
SG200-S4-12030	12	30	75	12	2	●
SG200-S4-12045	12	45	100	12	2	●

● Stock ○ Available upon Order

D	Tol
D < 6	0 -0.02
6 ≤ D ≤ 12	0 -0.03

Unit (mm)

Workpiece Material						
P		M	K	N		
1234	5	123	123	123	4	5
Carbon Steel, Alloy Steel (<35HRC)	Alloy Steel, Tool Steel (<48HRC)	Stainless Steel	Cast Iron	Aluminium Alloys	Copper Alloys	Graphite
				○	○	◎

◎ Most Suitable ○ Suitable

Recommended Cutting Data ※ P570

SG200-R4

4 Flutes, Corner Radius

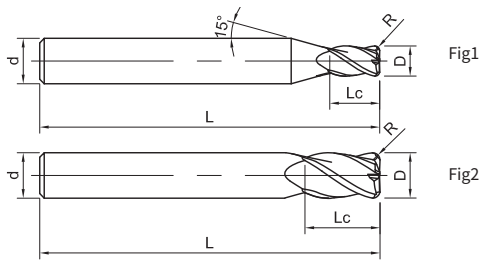

Please refer to page 167

Ordering Code	D	Lc	R	L	d	Figure No.	Stock
SG200-R4-02002	2	3.5	0.2	50	4	1	●
SG200-R4-02005	2	3.5	0.5	60	4	1	○
SG200-R4-03002	3	4	0.2	50	4	1	●
SG200-R4-03005	3	4	0.5	75	4	1	●
SG200-R4-03010	3	4	1	75	4	1	●
SG200-R4-04002	4	6	0.2	50	4	2	●
SG200-R4-04010	4	6	1	50	4	2	●
SG200-R4-05003	5	7	0.3	50	6	1	○
SG200-R4-06005	6	9	0.5	50	6	2	●
SG200-R4-06010	6	9	1	50	6	2	●
SG200-R4-08005	8	12	0.5	60	8	2	●
SG200-R4-08010	8	12	1	60	8	2	●
SG200-R4-10005	10	15	0.5	75	10	2	●
SG200-R4-10010	10	15	1	75	10	2	●
SG200-R4-12005	12	18	0.5	75	12	2	●
SG200-R4-12010	12	18	1	75	12	2	●
SG200-R4-16010	16	36	1	100	16	2	●

● Stock ○ Available upon Order

D	Tol
D < 6	0 -0.02
6 ≤ D ≤ 12	0 -0.03

Unit (mm)

Workpiece Material						
P		M	K	N		
1234	5	123	123	123	4	5
Carbon Steel, Alloy Steel (<35HRC)	Alloy Steel, Tool Steel (<48HRC)	Stainless Steel	Cast Iron	Aluminium Alloys	Copper Alloys	Graphite
				○	○	◎

◎ Most Suitable ○ Suitable

Recommended Cutting Data ※ P570

SG200-RN4

4 Flutes, Corner Radius, Long Neck

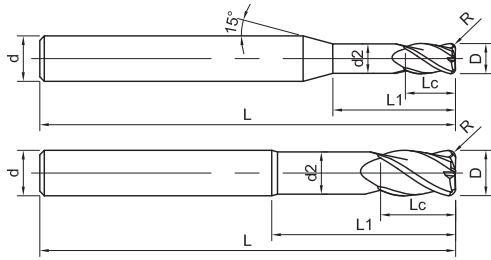

Fig1

Fig2



Please refer to page 167

Ordering Code	D	Lc	R	d2	L1	L	d	Figure No.	Stock
SG200-RN4-02002	2	3.5	0.2	1.92	6	50	4	1	●
SG200-RN4-02003	2	3.5	0.3	1.92	30	60	4	1	●
SG200-RN4-02005	2	3.5	0.5	1.92	30	60	4	1	●
SG200-RN4-03002	3	4	0.2	2.9	10	50	4	1	●
SG200-RN4-03003	3	4	0.3	2.9	20	50	4	1	○
SG200-RN4-03005	3	4	0.5	2.9	20	75	4	1	○
SG200-RN4-03010	3	4	1	2.9	20	75	4	1	●
SG200-RN4-04002	4	6	0.2	3.9	20	75	4	2	●
SG200-RN4-04005	4	6	0.5	3.9	20	50	4	2	●
SG200-RN4-04010	4	6	1	3.9	20	50	4	2	●
SG200-RN4-06005	6	9	0.5	5.9	25	75	6	2	●
SG200-RN4-06010	6	9	1	5.9	25	75	6	2	●
SG200-RN4-08005	8	12	0.5	7.9	30	100	8	2	●
SG200-RN4-08010	8	12	1	7.9	30	100	8	2	●
SG200-RN4-10005	10	15	0.5	9.8	45	100	10	2	●
SG200-RN4-10010	10	15	1	9.8	35	100	10	2	●
SG200-RN4-12005	12	18	0.5	11.8	40	100	12	2	●
SG200-RN4-12010	12	18	1	11.8	40	100	12	2	●

● Stock ○ Available upon Order

D	Tol
D < 6	0 -0.02
6 ≤ D ≤ 12	0 -0.03

Unit (mm)

Workpiece Material

P		M	K	N		
1234	5	123	123	123	4	5
Carbon Steel, Alloy Steel (<35HRC)	Alloy Steel, Tool Steel (<48HRC)	Stainless Steel	Cast Iron	Aluminium Alloys	Copper Alloys	Graphite
				○	○	◎

◎ Most Suitable ○ Suitable

Recommended Cutting Data ※ P570

SG200-B2

2 Flutes, Ballnose

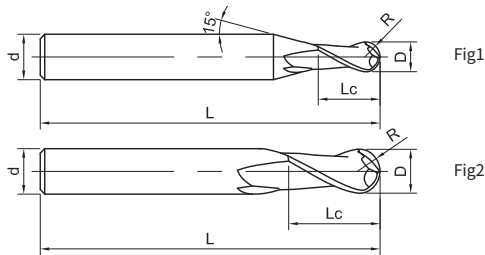

Please refer to page 167

Ordering Code	D	R	Lc	L	d	Figure No.	Stock
SG200-B2-00502	0.5	0.25	2	50	4	1	●
SG200-B2-00602	0.6	0.3	2	50	4	1	●
SG200-B2-00803	0.8	0.4	3	50	4	1	○
SG200-B2-01002	1	0.5	2	50	4	1	●
SG200-B2-01503	1.5	0.75	3	50	4	1	●
SG200-B2-02004	2	1	4	50	4	1	●
SG200-B2-02006	2	1	6	60	4	1	●
SG200-B2-03006	3	1.5	6	50	4	1	●
SG200-B2-03008	3	1.5	8	60	4	1	●
SG200-B2-04008	4	2	8	50	4	2	●
SG200-B2-04016	4	2	16	60	4	2	●
SG200-B2-05010	5	2.5	10	50	6	1	○
SG200-B2-06012	6	3	12	50	6	2	○
SG200-B2-08014	8	4	14	60	8	2	●
SG200-B2-10018	10	5	18	75	10	2	●
SG200-B2-12022	12	6	22	75	12	2	●

● Stock ○ Available upon Order

D	Tol
R < 3	0 -0.02
3 ≤ R ≤ 6	0 -0.03

Unit (mm)

Workpiece Material						
P		M	K	N		
1234	5	123	123	123	4	5
Carbon Steel, Alloy Steel (<35HRC)	Alloy Steel, Tool Steel (<48HRC)	Stainless Steel	Cast Iron	Aluminium Alloys	Copper Alloys	Graphite
				○	○	◎

◎ Most Suitable ○ Suitable

Recommended Cutting Data ※ P571

SG200-BN2

2 Flutes, Ballnose, with Long Neck

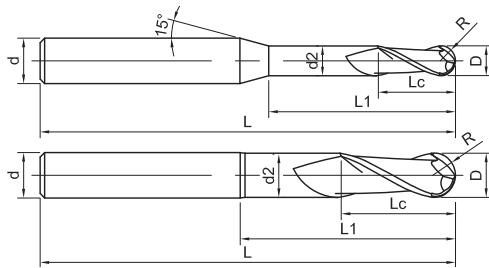
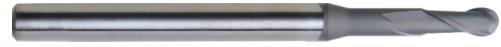

Fig1

Fig2



Please refer to page 167

Ordering Code	D	R	Lc	d2	L1	L	d	Figure No.	Stock
SG200-BN2-00508	0.5	0.25	2	0.45	8	50	4	1	●
SG200-BN2-01010	1	0.5	3	0.95	10	50	4	1	●
SG200-BN2-01015	1	0.5	3	0.95	15	60	4	1	●
SG200-BN2-01020	1	0.5	3	0.95	20	60	4	1	●
SG200-BN2-01515	1.5	0.75	3	1.44	15	50	4	1	●
SG200-BN2-02015	2	1	6	1.95	15	75	4	1	●
SG200-BN2-02020	2	1	4	1.92	20	75	4	1	●
SG200-BN2-02030	2	1	6	1.92	30	75	4	1	●
SG200-BN2-03015	3	1.5	6	2.9	15	50	4	1	●
SG200-BN2-03020	3	1.5	6	2.9	20	75	4	1	●
SG200-BN2-04012	4	2	8	3.9	12	60	4	2	●
SG200-BN2-04020	4	2	8	3.9	20	60	4	2	○

● Stock ○ Available upon Order

D	Tol
R < 3	0 -0.02
3 ≤ R ≤ 6	0 -0.03

Unit (mm)

Workpiece Material

P		M	K	N		
1234	5	123	123	123	4	5
Carbon Steel, Alloy Steel (<35HRC)	Alloy Steel, Tool Steel (<48HRC)	Stainless Steel	Cast Iron	Aluminium Alloys	Copper Alloys	Graphite
				○	○	◎

◎ Most Suitable ○ Suitable

Recommended Cutting Data ※ P571

SG200-BN2

2 Flutes, Ballnose, with Long Neck

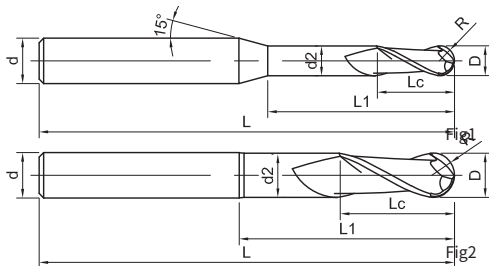

Fig1

Fig2



Please refer to page 167

» Continuation

Ordering Code	D	R	Lc	d2	L1	L	d	Figure No.	Stock
SG200-BN2-06018	6	3	12	5.9	18	75	6	2	●
SG200-BN2-06025	6	3	16	5.9	25	75	6	2	●
SG200-BN2-06030	6	3	12	5.9	30	75	6	2	●
SG200-BN2-08024	8	4	14	7.9	24	100	8	2	●
SG200-BN2-08030	8	4	20	7.9	30	100	8	2	○
SG200-BN2-08040	8	4	14	7.9	40	100	8	2	●
SG200-BN2-10030	10	5	18	9.8	30	100	10	2	●
SG200-BN2-10040	10	5	22	9.8	40	100	10	2	●
SG200-BN2-10050	10	5	18	9.8	50	100	10	2	○
SG200-BN2-12035	12	6	22	11.8	35	100	12	2	○
SG200-BN2-12050	12	6	22	11.8	50	100	12	2	○

● Stock ○ Available upon Order

D	Tol
R<3	0 -0.02
3≤R≤6	0 -0.03

Unit (mm)

Workpiece Material						
P	M	K	N			
1234	5	123	123	123	4	5
Carbon Steel, Alloy Steel (<35HRC)	Alloy Steel, Tool Steel (<48HRC)	Stainless Steel	Cast Iron	Aluminium Alloys	Copper Alloys	Graphite
				○	○	◎

◎ Most Suitable ○ Suitable

Recommended Cutting Data ※ P571

SG200-M-RN4

4 Flutes, Corner Radius, Long Neck

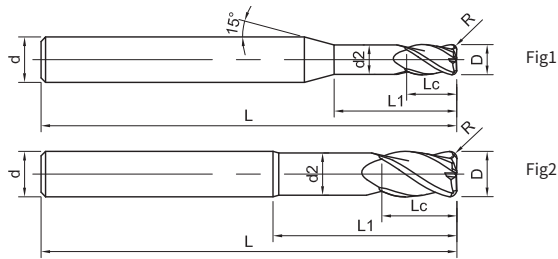

Please refer to page 167

Ordering Code	D	Lc	R	d2	L1	L	d	Figure No.	Stock
SG200-M-RN4-1-6-0.1-50	1	2	0.1	0.96	6	50	4	1	●
SG200-M-RN4-2-6-0.15-50	2	3.5	0.15	1.92	6	50	4	1	●
SG200-M-RN4-2-12-0.15-50	2	3.5	0.15	1.92	12	50	4	1	○
SG200-M-RN4-2-6-0.2-50	2	3.5	0.2	1.92	6	50	4	1	●
SG200-M-RN4-2-12-0.2-50	2	3.5	0.2	1.92	12	50	4	1	○
SG200-M-RN4-2-6-0.3-50	2	3.5	0.3	1.92	6	50	4	1	●
SG200-M-RN4-2-12-0.3-50	2	3.5	0.3	1.92	12	50	4	1	○
SG200-M-RN4-3-10-0.15-50	3	4	0.15	2.9	10	50	4	1	●
SG200-M-RN4-3-10-0.2-50	3	4	0.2	2.9	10	50	4	1	●
SG200-M-RN4-3-15-0.2-50	3	4	0.2	2.9	15	50	4	1	○
SG200-M-RN4-3-10-0.5-50	3	4	0.5	2.9	10	50	4	1	●
SG200-M-RN4-4-10-0.2-50	4	6	0.2	3.9	10	50	4	2	●
SG200-M-RN4-4-15-0.5-50	4	6	0.5	3.9	15	50	4	2	●
SG200-M-RN4-4-10-1-50	4	6	1	3.9	10	50	4	2	●
SG200-M-RN4-6-25-0.5-50	6	9	0.5	5.9	25	50	6	2	●
SG200-M-RN4-6-25-1-50	6	9	1	5.9	25	50	6	2	●
SG200-M-RN4-6-20-1.5-50	6	15	1.5	5.9	20	50	6	2	●
SG200-M-RN4-6-20-2-50	6	15	2	5.9	20	50	6	2	●
SG200-M-RN4-8-30-1-60	8	10	1	7.9	30	60	8	2	●
SG200-M-RN4-10-35-0.5-75	10	15	0.5	9.8	35	75	10	2	●
SG200-M-RN4-10-45-1-75	10	15	1	9.8	45	75	10	2	○

● Stock ○ Available upon Order

D	Tol
D ≤ 4	0 -0.010
D > 4	0 -0.015

Unit (mm)

Workpiece Material

P		M	K	N		
1234	5	123	123	123	4	5
Carbon Steel, Alloy Steel (<35HRC)	Alloy Steel, Tool Steel (<48HRC)	Stainless Steel	Cast Iron	Aluminium Alloys	Copper Alloys	Graphite
						○

○ Most Suitable ○ Suitable

Recommended Cutting Data ※ P571

SG200-M-B2

2 Flutes, Ballnose

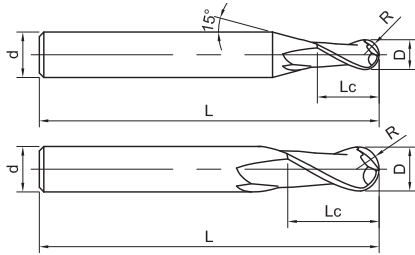

Fig1

Fig2



Please refer to page 167

Ordering Code	D	R	Lc	L	d	Figure No.	Stock
SG200-M-B2-0.4-1.5-50	0.4	0.2	1.5	50	4	1	●
SG200-M-B2-0.5-2-50	0.5	0.25	2	50	4	1	●
SG200-M-B2-0.6-2-50	0.6	0.3	2	50	4	1	●
SG200-M-B2-0.8-3-50	0.8	0.4	3	50	4	1	●
SG200-M-B2-1-3-50	1	0.5	3	50	4	1	●
SG200-M-B2-1.5-5-50	1.5	0.75	5	50	4	1	●
SG200-M-B2-2-6-50	2	1	6	50	4	1	●
SG200-M-B2-3-8-50	3	1.5	8	50	4	1	●
SG200-M-B2-4-16-50	4	2	16	50	4	2	●
SG200-M-B2-5-16-50	5	2.5	16	50	6	1	●
SG200-M-B2-6-16-50	6	3	16	50	6	2	●

● Stock ○ Available upon Order

R	Tol
R ≤ 0.4	±0.003
R > 0.4	±0.005

Unit (mm)

Workpiece Material						
P		M	K	N		
1234	5	123	123	123	4	5
Carbon Steel, Alloy Steel (<35HRC)	Alloy Steel, Tool Steel (<48HRC)	Stainless Steel	Cast Iron	Aluminium Alloys	Copper Alloys	Graphite
						○

○ Most Suitable ○ Suitable

Recommended Cutting Data ※ P571

SG200-M-BN2

2 Flutes, Ballnose, with Long Neck

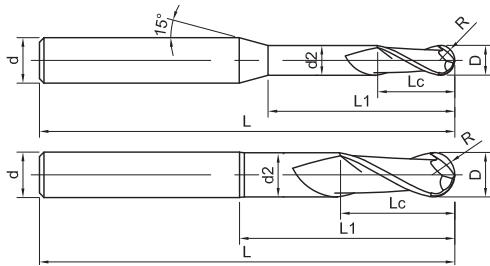

Fig1

Fig2



Please refer to page 167

Ordering Code	D	R	Lc	d2	L1	L	d	Figure No.	Stock
SG200-M-BN2-0.5-8-50	0.5	0.25	2	0.46	8	50	4	1	●
SG200-M-BN2-0.6-10-50	0.6	0.3	2	0.55	10	50	4	1	●
SG200-M-BN2-0.8-15-50	0.8	0.4	3	0.75	15	50	4	1	●
SG200-M-BN2-1-2.5-45	1	0.5	1.5	0.95	2.5	45	4	1	●
SG200-M-BN2-1-7-50	1	0.5	3	0.95	7	50	4	1	●
SG200-M-BN2-1-10-50	1	0.5	3	0.95	10	50	4	1	●
SG200-M-BN2-1-15-50	1	0.5	3	0.95	15	50	4	1	●
SG200-M-BN2-2-5-45	2	1	3	1.92	5	45	4	1	●
SG200-M-BN2-2-8-50	2	1	3	1.95	8	50	4	1	●
SG200-M-BN2-2-10-50	2	1	6	1.92	10	50	4	1	●
SG200-M-BN2-3-15-50	3	1.5	8	2.90	15	50	4	1	●
SG200-M-BN2-4-25-50	4	2	8	3.90	25	50	4	2	●
SG200-M-BN2-6-25-50	6	3	16	5.90	25	50	6	2	●

● Stock ○ Available upon Order

R	Tol
R ≤ 0.4	±0.003
R > 0.4	±0.005

Unit (mm)

Workpiece Material						
P		M	K	N		
1234	5	123	123	123	4	5
Carbon Steel, Alloy Steel (<35HRC)	Alloy Steel, Tool Steel (<48HRC)	Stainless Steel	Cast Iron	Aluminium Alloys	Copper Alloys	Graphite
						⊙

⊙ Most Suitable ○ Suitable

Recommended Cutting Data ※ P571

ST210-S4

4 Flutes, Square, with Unequal Tooth Pitch

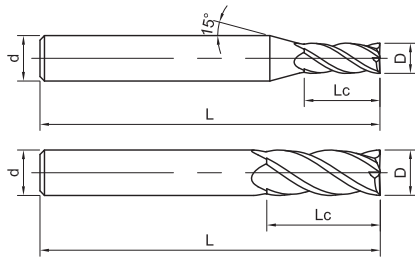
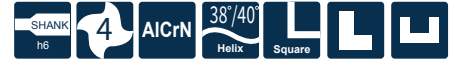

Fig1

Fig2



Please refer to page 167

Ordering Code	D	Lc	L	d	Figure No.	Stock
ST210-S4-01003	1	3	50	4	1	○
ST210-S4-01504	1.5	4	50	4	1	○
ST210-S4-02006	2	6	50	4	1	●
ST210-S4-02506	2.5	6	50	4	1	●
ST210-S4-02508	2.5	8	50	4	1	○
ST210-S4-03009	3	9	50	4	1	●
ST210-S4-03510	3.5	10	50	4	1	●
ST210-S4-04011	4	11	50	4	2	●
ST210-S4-04511	4.5	11	50	6	1	●
ST210-S4-05013	5	13	50	6	1	●
ST210-S4-06016	6	16	50	6	2	●
ST210-S4-08020	8	20	60	8	2	●
ST210-S4-10025	10	25	72	10	2	●
ST210-S4-12030	12	30	75	12	2	●
ST210-S4-14032	14	32	80	14	2	○
ST210-S4-16036	16	36	100	16	2	●
ST210-S4-20045	20	45	100	20	2	●

● Stock ○ Available upon Order

D	Tol
D<6	0 -0.02
6≤D≤16	0 -0.03
D>16	0 -0.04

Unit (mm)

Workpiece Material				
P		M	S	
1 2 3 4	5	1 2 3	1 2 3	4
Carbon Steel, Alloy Steel (<35HRC)	Alloy Steel, Tool Steel (<48HRC)	Stainless Steel	Heat-resistant Alloys	Titanium Alloys
○	○	○	○	○

○ Most Suitable ○ Suitable

Recommended Cutting Data ※ P572

ST210-R4

4 Flutes, Cornor Raidus, with Unequal Tooth Pitch

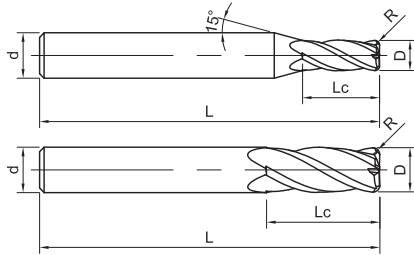

Fig1

Fig2



Please refer to page 167

Ordering Code	D	R	Lc	L	d	Figure No.	Stock
ST210-R4-02002	2	0.2	6	50	4	1	●
ST210-R4-03003	3	0.3	9	50	4	1	●
ST210-R4-03005	3	0.5	9	50	4	1	●
ST210-R4-04003	4	0.3	11	50	4	2	●
ST210-R4-04005	4	0.5	11	50	4	2	●
ST210-R4-04010	4	1	11	50	4	2	●
ST210-R4-05005	5	0.5	13	50	6	1	●
ST210-R4-06005	6	0.5	16	50	6	2	●
ST210-R4-06010	6	1	16	50	6	2	●
ST210-R4-08005	8	0.5	20	60	8	2	●
ST210-R4-08010	8	1	20	60	8	2	●
ST210-R4-10005	10	0.5	25	72	10	2	●
ST210-R4-10010	10	1	25	72	10	2	●
ST210-R4-10020	10	2	25	72	10	2	●
ST210-R4-10030	10	3	25	72	10	2	○
ST210-R4-12005	12	0.5	30	75	12	2	●
ST210-R4-12010	12	1	30	75	12	2	●

● Stock ○ Available upon Order

D	Tol
D<6	0 -0.02
6≤D≤16	0 -0.03
D>16	0 -0.04

Unit (mm)

Workpiece Material				
P		M	S	
1 2 3 4	5	1 2 3	1 2 3	4
Carbon Steel, Alloy Steel (<35HRC)	Alloy Steel, Tool Steel (<48HRC)	Stainless Steel	Heat-resistant Alloys	Titanium Alloys
○	○	○	○	○

○ Most Suitable ○ Suitable

Recommended Cutting Data ※ P572

ST210-R4

4 Flutes, Corner Radius, with Unequal Tooth Pitch

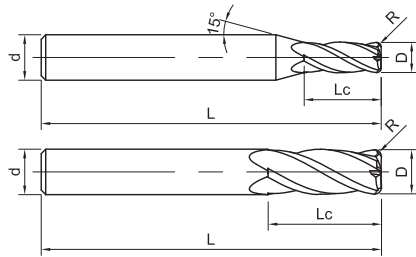

Fig1

Fig2



Please refer to page 167

» Continuation

Ordering Code	D	R	Lc	L	d	Figure No.	Stock
ST210-R4-12020	12	2	30	75	12	2	●
ST210-R4-12030	12	3	30	75	12	2	●
ST210-R4-16005	16	0.5	36	100	16	2	○
ST210-R4-16010	16	1	36	100	16	2	●
ST210-R4-16020	16	2	36	100	16	2	○
ST210-R4-16030	16	3	36	100	16	2	●
ST210-R4-16040	16	4	36	100	16	2	○
ST210-R4-16050	16	5	36	100	16	2	○
ST210-R4-20005	20	0.5	45	100	20	2	●
ST210-R4-20010	20	1	45	100	20	2	●
ST210-R4-20020	20	2	45	100	20	2	○
ST210-R4-20030	20	3	45	100	20	2	●
ST210-R4-20040	20	4	45	100	20	2	○
ST210-R4-20050	20	5	45	100	20	2	●

● Stock ○ Available upon Order

D	Tol
D ≤ 16	0 -0.03
D > 16	0 -0.04

Unit (mm)

Workpiece Material				
P		M	S	
1 2 3 4	5	1 2 3	1 2 3	4
Carbon Steel, Alloy Steel (<35HRC)	Alloy Steel, Tool Steel (<48HRC)	Stainless Steel	Heat-resistant Alloys	Titanium Alloys
○	○	◎	○	◎

◎ Most Suitable ○ Suitable

Recommended Cutting Data ※ P572

ST210-RN4

4 Flutes, Cornor Raidus, with Unequal Tooth Pitch and Long Neck

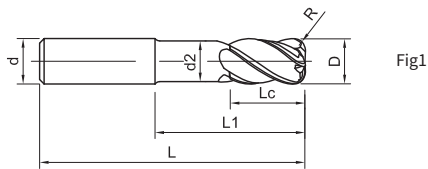

Please refer to page 167

Ordering Code	D	R	Lc	L1	d2	L	d	Figure No.	Stock
ST210-RN4-06005	6	0.5	12	18	5.4	60	6	1	●
ST210-RN4-06010	6	1	12	18	5.4	60	6	1	●
ST210-RN4-08005	8	0.5	16	25	7.4	75	8	1	●
ST210-RN4-08010	8	1	16	25	7.4	75	8	1	●
ST210-RN4-10005	10	0.5	20	30	9.4	75	10	1	●
ST210-RN4-10005A	10	0.5	30	50	9.4	90	10	1	○
ST210-RN4-10010	10	1	20	30	9.4	75	10	1	●
ST210-RN4-10010A	10	1	30	50	9.4	90	10	1	○
ST210-RN4-10020	10	2	20	30	9.4	75	10	1	●
ST210-RN4-10020A	10	2	30	50	9.4	90	10	1	●
ST210-RN4-10030	10	3	20	30	9.4	75	10	1	●
ST210-RN4-10030A	10	3	30	50	9.4	90	10	1	●
ST210-RN4-10030B	10	3	30	60	9.4	100	10	1	●
ST210-RN4-10030C	10	3	30	40	9.4	90	10	1	●
ST210-RN4-12005	12	0.5	24	40	11.4	90	12	1	●
ST210-RN4-12005A	12	0.5	24	50	11.4	100	12	1	○
ST210-RN4-12010	12	1	24	40	11.4	90	12	1	●
ST210-RN4-12010A	12	1	24	50	11.4	100	12	1	○
ST210-RN4-12020	12	2	24	40	11.4	90	12	1	●
ST210-RN4-12020A	12	2	24	50	11.4	100	12	1	○

● Stock ○ Available upon Order

D	Tol
D≤16	0 -0.03
D>16	0 -0.04

Unit (mm)

Workpiece Material				
P		M	S	
1 2 3 4	5	1 2 3	1 2 3	4
Carbon Steel, Alloy Steel (<35HRC)	Alloy Steel, Tool Steel (<48HRC)	Stainless Steel	Heat-resistant Alloys	Titanium Alloys
○	○	○	○	○

○ Most Suitable ○ Suitable

Recommended Cutting Data ※ P572

ST210-RN4

4 Flutes, Corner Radius, with Unequal Tooth Pitch and Long Neck

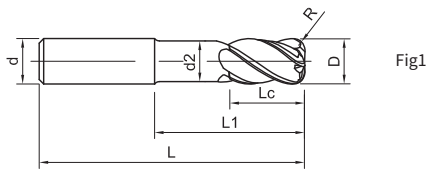

Please refer to page 167

» Continuation

Ordering Code	D	R	Lc	L1	d2	L	d	Figure No.	Stock
ST210-RN4-12030A	12	3	24	40	11.4	90	12	1	●
ST210-RN4-12030B	12	3	36	50	11.4	100	12	1	●
ST210-RN4-12030C	12	3	36	60	11.4	110	12	1	●
ST210-RN4-16005	16	0.5	32	50	15.4	100	16	1	●
ST210-RN4-16005A	16	0.5	32	60	15.4	110	16	1	●
ST210-RN4-16010	16	1	32	50	15.4	100	16	1	●
ST210-RN4-16010A	16	1	32	70	15.4	120	16	1	●
ST210-RN4-16010B	16	1	32	80	15.4	130	16	1	●
ST210-RN4-16010C	16	1	32	60	15.4	110	16	1	○
ST210-RN4-16020	16	2	32	50	15.4	100	16	1	●
ST210-RN4-16020A	16	2	32	60	15.4	110	16	1	○
ST210-RN4-16030	16	3	32	50	15.4	100	16	1	●
ST210-RN4-16030A	16	3	32	70	15.4	120	16	1	●
ST210-RN4-16030B	16	3	32	80	15.4	130	16	1	●
ST210-RN4-16030C	16	3	32	60	15.4	110	16	1	○
ST210-RN4-16040	16	4	32	50	15.4	100	16	1	●
ST210-RN4-16040A	16	4	32	60	15.4	110	16	1	●
ST210-RN4-16050	16	5	32	50	15.4	100	16	1	○
ST210-RN4-16050A	16	5	32	60	15.4	110	16	1	○
ST210-RN4-16050B	16	5	32	70	15.4	120	16	1	●

● Stock ○ Available upon Order

D	Tol
D ≤ 16	0 -0.03
D > 16	0 -0.04

Unit (mm)

Workpiece Material				
P		M	S	
1 2 3 4	5	1 2 3	1 2 3	4
Carbon Steel, Alloy Steel (<35HRC)	Alloy Steel, Tool Steel (<48HRC)	Stainless Steel	Heat-resistant Alloys	Titanium Alloys
○	○	○	○	○

○ Most Suitable ○ Suitable

Recommended Cutting Data ※ P572

ST210-RN4

4 Flutes, Cornor Raidus, with Unequal Tooth Pitch and Long Neck

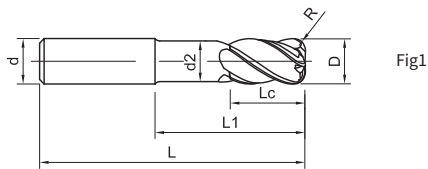

Please refer to page 167

» Continuation

Ordering Code	D	R	Lc	L1	d2	L	d	Figure No.	Stock
ST210-RN4-16050C	16	5	32	80	15.4	130	16	1	○
ST210-RN4-20005	20	0.5	40	60	19.4	110	20	1	●
ST210-RN4-20005A	20	0.5	40	80	19.4	130	20	1	●
ST210-RN4-20010	20	1	40	60	19.4	110	20	1	●
ST210-RN4-20010A	20	1	40	80	19.4	130	20	1	●
ST210-RN4-20010B	20	1	40	70	19.4	120	20	1	●
ST210-RN4-20010C	20	1	40	100	19.4	150	20	1	●
ST210-RN4-20020	20	2	40	60	19.4	110	20	1	●
ST210-RN4-20020A	20	2	40	80	19.4	130	20	1	●
ST210-RN4-20030	20	3	40	60	19.4	110	20	1	●
ST210-RN4-20030A	20	3	40	80	19.4	130	20	1	●
ST210-RN4-20030B	20	3	40	100	19.4	150	20	1	●
ST210-RN4-20030C	20	3	40	70	19.4	120	20	1	●
ST210-RN4-20040	20	4	40	60	19.4	110	20	1	●
ST210-RN4-20040A	20	4	40	80	19.4	130	20	1	○
ST210-RN4-20050	20	5	40	60	19.4	110	20	1	●
ST210-RN4-20050A	20	5	40	80	19.4	130	20	1	●
ST210-RN4-20050B	20	5	40	100	19.4	150	20	1	●
ST210-RN4-20050C	20	5	40	70	19.4	120	20	1	●

● Stock ○ Available upon Order

D	Tol
D ≤ 16	0 -0.03
D > 16	0 -0.04

Unit (mm)

Workpiece Material				
P		M	S	
1 2 3 4	5	1 2 3	1 2 3	4
Carbon Steel, Alloy Steel (<35HRC)	Alloy Steel, Tool Steel (<48HRC)	Stainless Steel	Heat-resistant Alloys	Titanium Alloys
○	○	○	○	○

○ Most Suitable ○ Suitable

Recommended Cutting Data ※ P572

ST210-RL5

5 Flutes, Corner Radius, with Unequal Tooth Pitch and Long Flute

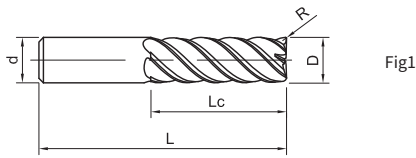

Please refer to page 167

Ordering Code	D	R	Lc	L	d	Figure No.	Stock
ST210-RL5-16005	16	0.5	48	100	16	1	○
ST210-RL5-16005A	16	0.5	80	130	16	1	●
ST210-RL5-20005	20	0.5	60	110	20	1	●
ST210-RL5-20005A	20	0.5	100	150	20	1	○
ST210-RL5-25005	25	0.5	75	155	25	1	○
ST210-RL5-25005A	25	0.5	125	205	25	1	○

● Stock ○ Available upon Order

D	Tol
D ≤ 16	0 -0.03
D > 16	0 -0.04

Unit (mm)

Workpiece Material				
P		M	S	
1 2 3 4	5	1 2 3	1 2 3	4
Carbon Steel, Alloy Steel (<35HRC)	Alloy Steel, Tool Steel (<48HRC)	Stainless Steel	Heat-resistant Alloys	Titanium Alloys
○	○	○	○	○

○ Most Suitable ○ Suitable

Recommended Cutting Data ※ P573

ST210-B4

4 Flutes, Ballnose, with Unequal Tooth Pitch

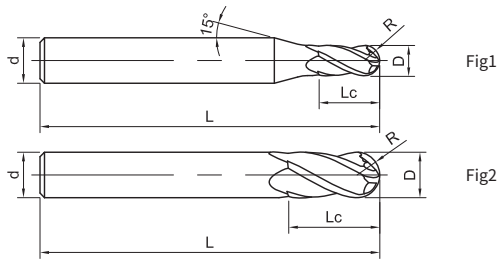

Please refer to page 167

Ordering Code	D	R	Lc	L	d	Figure No.	Stock
ST210-B4-02004	2	1	4	50	6	1	●
ST210-B4-03006	3	1.5	6	50	6	1	●
ST210-B4-04008	4	2	8	50	6	1	●
ST210-B4-05010	5	2.5	10	50	6	1	○
ST210-B4-06012	6	3	12	50	6	2	●
ST210-B4-08014	8	4	14	60	8	2	●
ST210-B4-10018	10	5	18	75	10	2	●
ST210-B4-12022	12	6	22	75	12	2	●
ST210-B4-16030	16	8	30	100	16	2	●
ST210-B4-20038	20	10	38	100	20	2	●

● Stock ○ Available upon Order

R	Tol
R<3	±0.010
3≤R≤6	±0.015
R<6	±0.020

Unit (mm)

Workpiece Material				
P		M	S	
1 2 3 4	5	1 2 3	1 2 3	4
Carbon Steel, Alloy Steel (<35HRC)	Alloy Steel, Tool Steel (<48HRC)	Stainless Steel	Heat-resistant Alloys	Titanium Alloys
○	○	◎	○	◎

◎ Most Suitable ○ Suitable

Recommended Cutting Data ※ P573

SM200-TP2

2 Flutes, Ballnose, with Long Neck

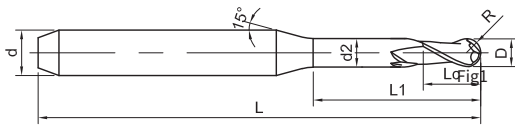

Fig1



Please refer to page 167

Ordering Code	D	R	Lc	d2	L1	L	d	Flute	Figure No.	Stock
SM200-TP2-1-12-50-d6	1	0.5	2.5	0.95	12	50	6	2	1	●
SM200-TP2-1.5-14-50-d6	1.5	0.75	3	1.45	14	50	6	2	1	○
SM200-TP2-2-16-50-d6	2	1	3	1.95	16	50	6	2	1	○
SM200-TP2-3-16-50-d6	3	1.5	4	2.95	16	50	6	2	1	○

● Stock ○ Available upon Order

R	Tol
0.5 ≤ R ≤ 1.5	±0.007

Unit (mm)

Workpiece Material				
N			S	
123	4	5	123	45
Aluminium Alloys	Copper Alloys	Zirconia	Heat-resistant Alloys	Titanium Alloy/ Cobalt-chromium Alloy
				○

○ Most Suitable ○ Suitable

Recommended Cutting Data ※ P574

SM200-RO2/RO3

2/3 Flutes, Ballnose, with Long Neck

互换设备: DWX50, DWX30, DWX51D

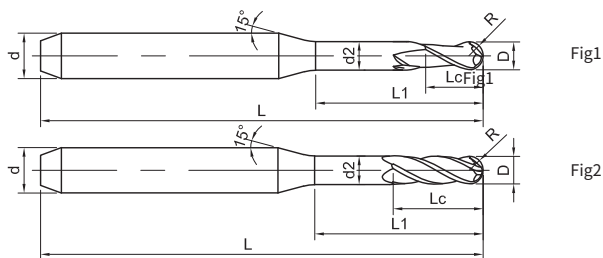

Please refer to page 167

Ordering Code	D	R	Lc	d2	L1	L	d	Flute	Figure No.	Stock
SM200-RO2-1.0-16-45	1	0.5	6	0.92	16	45	4	2	1	●
SM200-RO2-2.0-16-45	2	1	8	1.92	16	45	4	2	1	●
SM200-RO2-0.6-6-50-d4	0.6	0.3	2	0.55	6	50	4	2	1	●
SM200-RO2-0.6-14-50-d4	0.6	0.3	2	0.55	14	50	4	2	1	○
SM200-RO2-1-16-50-d4	1	0.5	6	0.95	16	50	4	2	1	●
SM200-RO2-1-20-50-d4	1	0.5	6	0.95	20	50	4	2	1	●
SM200-RO2-2-16-50-d4	2	1	8	1.95	16	50	4	2	1	●
SM200-RO2-2-20-50-d4	2	1	8	1.95	20	50	4	2	1	●
SM200-RO2-3-20-50-d4	3	1.5	10	2.95	20	50	4	2	1	●
SM200-RO3-1-16-50-d4	1	0.5	6	0.95	16	50	4	3	2	○
SM200-RO3-1-20-50-d4	1	0.5	6	0.95	20	50	4	3	2	○
SM200-RO3-2-16-50-d4	2	1	8	1.95	16	50	4	3	2	○
SM200-RO3-2-20-50-d4	2	1	8	1.95	20	50	4	3	2	○
SM200-RO3-3-20-50-d4	3	1.5	10	2.95	20	50	4	3	2	○

● Stock ○ Available upon Order

R	Tol
0.3 ≤ R ≤ 1.5	±0.007

Unit (mm)

Workpiece Material				
N			S	
123	4	5	123	45
Aluminium Alloys	Copper Alloys	Zirconia	Heat-resistant Alloys	Titanium Alloy/ Cobalt-chromium Alloy
		○		

○ Most Suitable ○ Suitable

Recommended Cutting Data ※ P574

SM200-VH2/VH3

2/3 Flutes, Ballnose, with Long Neck

Interchangeable equipment: 5Axes, Wieland, Brux Zir, EzMill, Jensen

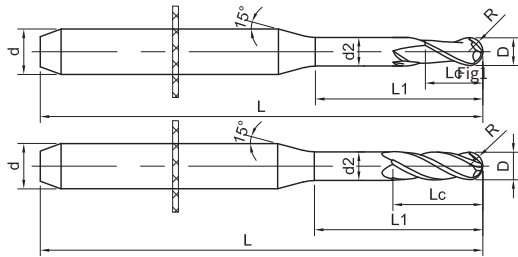

Fig1

Fig2



Please refer to page 167

Ordering Code	D	R	Lc	d2	L1	L	d	Flute	Figure No.	Stock
SM200-VH2-0.6-7-40-d3	0.6	0.3	2	0.55	7	40	3	2	1	○
SM200-VH2-0.6-11-40-d3	0.6	0.3	2	0.55	11	40	3	2	1	○
SM200-VH2-1-17-40-d3	1	0.5	5	0.95	17	40	3	2	1	○
SM200-VH2-2-17-40-d3	2	1	8	1.95	17	40	3	2	1	○
SM200-VH3-1-16-40-d3	1	0.5	5	0.95	16	40	3	3	2	●
SM200-VH3-2-17-40-d3	2	1	8	1.95	17	40	3	3	2	●

● Stock ○ Available upon Order

R	Tol
0.3 ≤ R ≤ 1	±0.007

Unit (mm)

Workpiece Material				
N			S	
123	4	5	123	45
Aluminium Alloys	Copper Alloys	Zirconia	Heat-resistant Alloys	Titanium Alloy/ Cobalt-chromium Alloy
		○		

○ Most Suitable ○ Suitable

Recommended Cutting Data ※ P574

SM200-WI2/WI3

2/3 Flutes, Ballnose, with Long Neck

Special equipment: Wieland

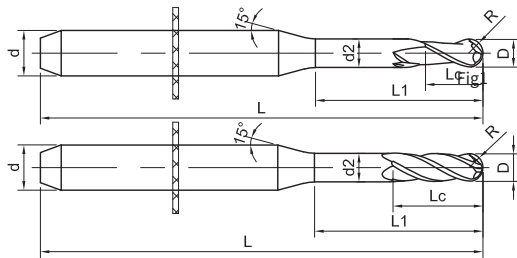

Fig1

Fig2



Please refer to page 167

Ordering Code	D	R	Lc	d2	L1	L	d	Flute	Figure No.	Stock
SM200-WI2-0.6-7-40-d3	0.6	0.3	2	0.55	7	40	3	2	1	○
SM200-WI2-0.7-7-40-d3	0.7	0.35	2	0.65	7	40	3	2	1	○
SM200-WI2-1-17-40-d3	1	0.5	5	0.95	17	40	3	2	1	○
SM200-WI2-2-17-40-d3	2	1	8	1.95	17	40	3	2	1	○
SM200-WI2-2.5-20-40-d3	2.5	1.25	10	2.45	20	40	3	2	1	●
SM200-WI3-1-17-40-d3	1	0.5	5	0.95	17	40	3	3	2	○
SM200-WI3-2-17-40-d3	2	1	8	1.95	17	40	3	3	2	○
SM200-WI3-2.5-20-40-d3	2.5	1.25	10	2.45	20	40	3	3	2	●

● Stock ○ Available upon Order

R	Tol
0.3 ≤ R ≤ 1.25	±0.007

Unit (mm)

Workpiece Material				
N			S	
123	4	5	123	45
Aluminium Alloys	Copper Alloys	Zirconia	Heat-resistant Alloys	Titanium Alloy/ Cobalt-chromium Alloy
		○		

○ Most Suitable ○ Suitable

Recommended Cutting Data ※ P574

SM200-IM2/IM3

2/3 Flutes, Ballnose, with Long Neck

Special equipment: 250i

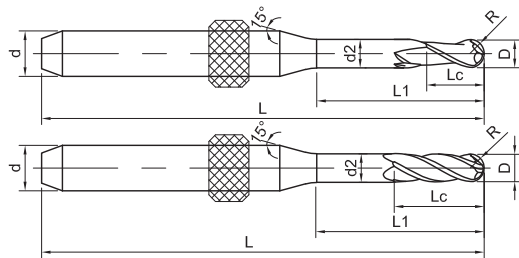

Fig1

Fig2



Please refer to page 167

Ordering Code	D	R	Lc	d2	L1	L	d	Flute	Figure No.	Stock
SM200-IM2-0.6-7-48-d3	0.6	0.3	2	0.55	7	48	3	2	1	○
SM200-IM2-0.65-12-48-d3	0.65	0.325	2	0.60	12	48	3	2	1	○
SM200-IM2-1-16-48-d3	1	0.5	2	0.95	16	48	3	2	1	●
SM200-IM2-2-20-48-d3	2	1	8	1.95	20	48	3	2	1	●
SM200-IM2-2.5-20-48-d3	2.5	1.25	9	2.45	20	48	3	2	1	●
SM200-IM3-1-16-48-d3	1	0.5	2	0.95	16	48	3	3	2	○
SM200-IM3-2-20-48-d3	2	1	8	1.95	20	48	3	3	2	○
SM200-IM3-2.5-20-48-d3	2.5	1.25	9	2.45	20	48	3	3	2	○

● Stock ○ Available upon Order

R	Tol
0.3 ≤ R ≤ 1.25	±0.007

Unit (mm)

Workpiece Material				
N			S	
123	4	5	123	45
Aluminium Alloys	Copper Alloys	Zirconia	Heat-resistant Alloys	Titanium Alloy/ Cobalt-chromium Alloy
		○		

○ Most Suitable ○ Suitable

Recommended Cutting Data ※ P574

SM200-IM2/IM3

2/3 Flutes, Ballnose, with Long Neck

Interchangeable equipment: 450i, 540i, DMG

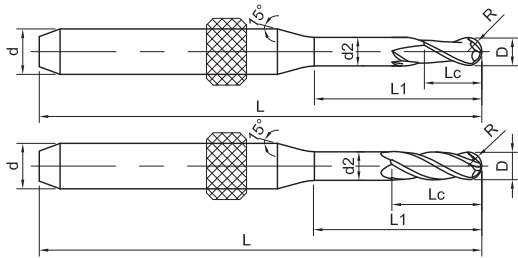

Fig1

Fig2



Please refer to page 167

Ordering Code	D	R	Lc	d2	L1	L	d	Flute	Figure No.	Stock
SM200-IM2-0.6-7-53-d6	0.6	0.3	2	0.55	7	53	6	2	1	●
SM200-IM2-0.65-12-53-d6	0.65	0.325	2	0.60	12	53	6	2	1	○
SM200-IM2-1-16-53-d6	1	0.5	2	0.95	16	53	6	2	1	●
SM200-IM2-2-20-53-d6	2	1	8	1.95	20	53	6	2	1	●
SM200-IM2-2.5-20-53-d6	2.5	1.25	9	2.45	20	53	6	2	1	●
SM200-IM3-1-16-53-d6	1	0.5	2	0.95	16	53	6	3	2	○
SM200-IM3-2-20-53-d6	2	1	8	1.95	20	53	6	3	2	○
SM200-IM3-2.5-20-53-d6	2.5	1.25	9	2.45	20	53	6	3	2	○

● Stock ○ Available upon Order

R	Tol
0.3 ≤ R ≤ 1.25	±0.007

Unit (mm)

Workpiece Material				
N			S	
123	4	5	123	45
Aluminium Alloys	Copper Alloys	Zirconia	Heat-resistant Alloys	Titanium Alloy/ Cobalt-chromium Alloy
		○		

○ Most Suitable ○ Suitable

Recommended Cutting Data ※ P574

SM200-ZI2/ZI3

2/3 Flutes, Ballnose, with Long Neck

Interchangeable equipment: M1, M5

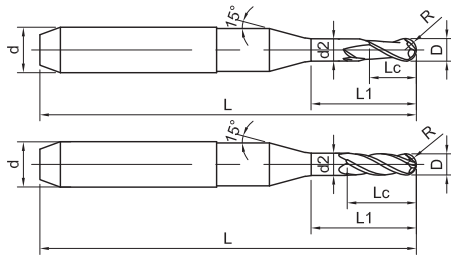

Fig1

Fig2



Please refer to page 167

Ordering Code	D	R	Lc	d2	L1	L	d	Flute	Figure No.	Stock
SM200-ZI2-0.5-5-57-d3	0.5	0.25	3	0.45	5	57	3	2	1	●
SM200-ZI2-0.5-5-50-d6	0.5	0.25	3	0.45	5	50	6	2	1	●
SM200-ZI2-1-16-57-d3	1	0.5	6	0.95	16	57	3	2	1	●
SM200-ZI2-1-12-50-d6	1	0.5	6	0.95	12	50	6	2	1	●
SM200-ZI2-2-18-57-d3	2	1	10	1.95	18	57	3	2	1	●
SM200-ZI2-2-18-50-d6	2	1	10	1.95	18	50	6	2	1	○
SM200-ZI3-1-16-57-d3	1	0.5	6	0.95	16	57	3	3	2	○
SM200-ZI3-1-12-50-d6	1	0.5	6	0.95	12	50	6	3	2	○
SM200-ZI3-2-18-57-d3	2	1	10	1.95	18	57	3	3	2	○
SM200-ZI3-2-18-50-d6	2	1	10	1.95	18	50	6	3	2	○

● Stock ○ Available upon Order

R	Tol
0.25 ≤ R ≤ 1.5	±0.007

Unit (mm)

Workpiece Material				
N			S	
123	4	5	123	45
Aluminium Alloys	Copper Alloys	Zirconia	Heat-resistant Alloys	Titanium Alloy/ Cobalt-chromium Alloy
		○		

○ Most Suitable ○ Suitable

Recommended Cutting Data ※ P574

SM200-ZI2

2 Flutes, Ballnose, with Long Neck

Special equipment: M1

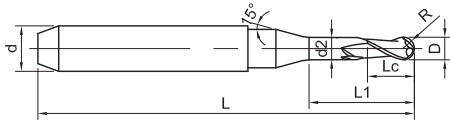

Fig1



Please refer to page 167

Ordering Code	D	R	Lc	d2	L1	L	d	Flute	Figure No.	Stock
SM200-ZI2-2-18-50-d6-R	2	1	3	1.95	18	50	6	2	1	○
SM200-ZI2-3-18-50-d6	3	1.5	4	2.95	18	50	6	2	1	○

● Stock ○ Available upon Order

R	Tol
0.25 ≤ R ≤ 1.25	±0.007

Unit (mm)

Workpiece Material				
N			S	
123	4	5	123	45
Aluminium Alloys	Copper Alloys	Zirconia	Heat-resistant Alloys	Titanium Alloy/ Cobalt-chromium Alloy
				○

○ Most Suitable ○ Suitable

Recommended Cutting Data ※ P574

SM200-AR2/AR3

2/3 Flutes, Ballnose, with Long Neck

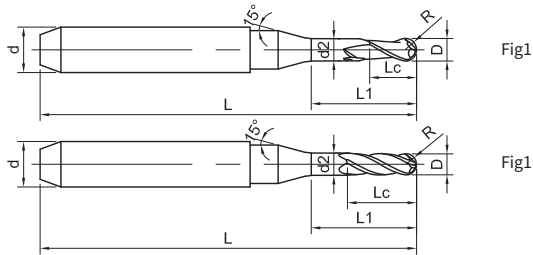

Please refer to page 167

Ordering Code	D	R	Lc	d2	L1	L	d	Flute	Figure No.	Stock
SM200-AR2-0.6-13-50-d6	0.6	0.3	2	0.55	13	50	6	2	1	●
SM200-AR2-0.6-13-63-d6	0.6	0.3	2	0.55	13	63	6	2	1	○
SM200-AR2-1-16-50-d6	1	0.5	6	0.95	16	50	6	2	1	●
SM200-AR2-1-16-63-d6	1	0.5	6	0.95	16	63	6	2	1	○
SM200-AR2-2-20-50-d6	2	1	8	1.95	20	50	6	2	1	●
SM200-AR2-2-20-63-d6	2	1	8	1.95	20	63	6	2	1	○
SM200-AR3-1-16-50-d6	1	0.5	6	0.95	16	50	6	3	2	○
SM200-AR3-1-16-63-d6	1	0.5	6	0.95	16	63	6	3	2	○
SM200-AR3-2-20-50-d6	2	1	8	1.95	20	50	6	3	2	○
SM200-AR3-2-20-63-d6	2	1	8	1.95	20	63	6	3	2	○

● Stock ○ Available upon Order

R	Tol
0.3 ≤ R ≤ 1.5	±0.007

Unit (mm)

Workpiece Material				
N			S	
123	4	5	123	45
Aluminium Alloys	Copper Alloys	Zirconia	Heat-resistant Alloys	Titanium Alloy/ Cobalt-chromium Alloy
		○		

○ Most Suitable ○ Suitable

Recommended Cutting Data ※ P575

SM200-AR2

2 Flutes, Ballnose, with Long Neck

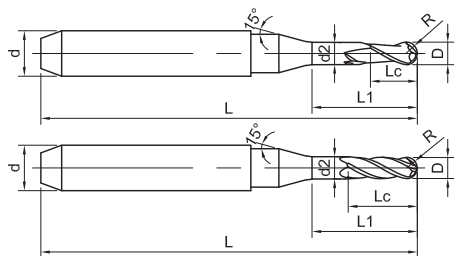

Fig1



Fig2



Please refer to page 167

Ordering Code	D	R	Lc	d2	L1	L	d	Flute	Figure No.	Stock
SM200-AR2-1-8-50-d6	1	0.5	3	0.95	8	50	6	2	1	●
SM200-AR2-1.5-10-50-d6	1.5	0.75	3	1.45	10	50	6	2	1	●
SM200-AR2-2-12-50-d6	2	1	3	1.95	12	50	6	2	1	●
SM200-AR2-3-14-50-d6	3	1.5	2.5	2.95	14	50	6	2	1	●

● Stock ○ Available upon Order

R	Tol
0.3 ≤ R ≤ 1.5	±0.007

Unit (mm)

Workpiece Material				
N			S	
123	4	5	123	45
Aluminium Alloys	Copper Alloys	Zirconia	Heat-resistant Alloys	Titanium Alloy/ Cobalt-chromium Alloy
				○

○ Most Suitable ○ Suitable

Recommended Cutting Data ※ P575

SM200-KL2

2 Flutes, Ballnose, with Long Neck

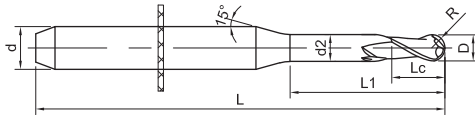

Fig1



Please refer to page 167

Ordering Code	D	R	Lc	d2	L1	L	d	Flute	Figure No.	Stock
SM200-KL2-0.6-7-40-d3	0.6	0.3	2	0.55	7	40	3	2	1	●
SM200-KL2-1.5-16-40-d3	1.5	0.75	6	1.45	16	40	3	2	1	●
SM200-KL2-1-16-40-d3	1	0.5	4	0.95	16	40	3	2	1	●
SM200-KL2-2-16-40-d3	2	1	8	1.95	16	40	3	2	1	●

● Stock ○ Available upon Order

R	Tol
0.3 ≤ R ≤ 1	±0.007

Unit (mm)

Workpiece Material				
N			S	
123	4	5	123	45
Aluminium Alloys	Copper Alloys	Zirconia	Heat-resistant Alloys	Titanium Alloy/ Cobalt-chromium Alloy
		○		

○ Most Suitable ○ Suitable

Recommended Cutting Data ※ P574

SM200-XT2

2 Flutes, Ballnose, with Long Neck

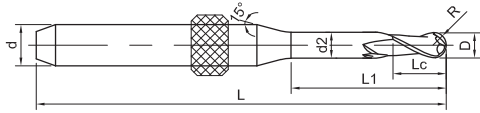

Fig1



Please refer to page 167

Ordering Code	D	R	Lc	d2	L1	L	d	Flute	Figure No.	Stock
SM200-XT2-0.6-5-50-d3	0.6	0.3	2	0.55	5	50	3	2	1	●
SM200-XT2-0.8-16-50-d3	0.8	0.4	6	0.72	16	50	3	2	1	●
SM200-XT2-1.5-16-50-d3	1.5	0.75	8	1.42	16	50	3	2	1	●
SM200-XT2-1-16-50-d3	1	0.5	6	0.95	16	50	3	2	1	●
SM200-XT2-2-16-50-d3	2	1	8	1.95	16	50	3	2	1	●
SM200-XT2-2-22-50-d3	2	1	8	1.95	22	50	3	2	1	●
SM200-XT2-2-25-50-d3	2	1	8	1.95	25	50	3	2	1	○
SM200-XT2-0.6-6-50-d4	0.6	0.3	2	0.55	6	50	4	2	1	●
SM200-XT2-1.5-16-50-d4	1.5	0.75	8	1.45	16	50	4	2	1	●
SM200-XT2-1-16-50-d4	1	0.5	6	0.95	16	50	4	2	1	●
SM200-XT2-2-16-50-d4	2	1	8	1.95	16	50	4	2	1	●
SM200-XT2-2-18-50-d4	2	1	8	1.95	18	50	4	2	1	●

● Stock ○ Available upon Order

R	Tol
$0.3 \leq R \leq 1.5$	± 0.007

Unit (mm)

Workpiece Material				
N			S	
123	4	5	123	45
Aluminium Alloys	Copper Alloys	Zirconia	Heat-resistant Alloys	Titanium Alloy/ Cobalt-chromium Alloy
		○		

○ Most Suitable ○ Suitable

Recommended Cutting Data ※ P575

SM200-XT2

2 Flutes, Ballnose, with Long Neck

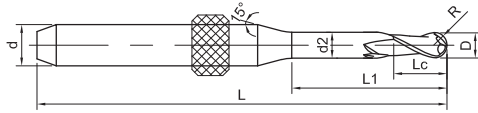

Fig1



Please refer to page 167

Ordering Code	D	R	Lc	d2	L1	L	d	Flute	Figure No.	Stock
SM200-XT2-1-10-50-d4	1	0.5	2.5	0.95	10	50	4	2	1	●
SM200-XT2-2-12-50-d4	2	1	2.5	1.95	12	50	4	2	1	●
SM200-XT2-3-14-50-d4	3	1.5	4	2.95	14	50	4	2	2	●

● Stock ○ Available upon Order

R	Tol
0.3 ≤ R ≤ 1.5	±0.007

Unit (mm)

Workpiece Material				
N			S	
123	4	5	123	45
Aluminium Alloys	Copper Alloys	Zirconia	Heat-resistant Alloys	Titanium Alloy/ Cobalt-chromium Alloy
				○

○ Most Suitable ○ Suitable

Recommended Cutting Data ※ P575

SN200-R4

4 Flutes, Cornor Raidus, with Unequal Tooth Pitch

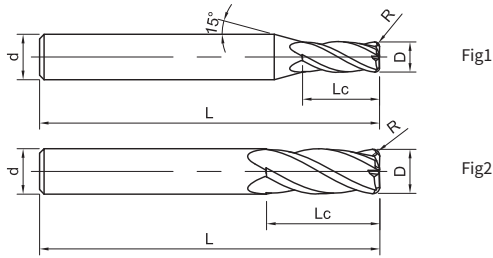

Please refer to page 167

Ordering Code	D	R	Lc	L	d	Figure No.	Stock
SN200-R4-01001	1	0.1	3	50	4	1	○
SN200-R4-61001	1	0.1	3	50	6	1	●
SN200-R4-01501	1.5	0.1	4.5	50	4	1	○
SN200-R4-61501	1.5	0.1	4.5	50	6	1	●
SN200-R4-02002	2	0.2	6	50	4	1	●
SN200-R4-62002	2	0.2	6	50	6	1	●
SN200-R4-02005	2	0.5	6	50	4	1	●
SN200-R4-62005	2	0.5	6	50	6	1	●
SN200-R4-03002	3	0.2	8	50	4	1	○
SN200-R4-63002	3	0.2	8	50	6	1	●
SN200-R4-03005	3	0.5	8	50	4	1	●
SN200-R4-63005	3	0.5	8	50	6	1	●
SN200-R4-04002	4	0.2	11	50	4	2	●
SN200-R4-64002	4	0.2	11	50	6	1	●
SN200-R4-04005	4	0.5	11	50	4	2	○
SN200-R4-64005	4	0.5	11	50	6	1	●
SN200-R4-05002	5	0.2	13	50	6	1	●
SN200-R4-05005	5	0.5	13	50	6	1	●

● Stock ○ Available upon Order

D	Tol
D ≤ 12	0 -0.03
D > 12	0 -0.04

Unit (mm)

Workpiece Material				
P		M	S	
1 2 3 4	5	1 2 3	1 2 3	4
Carbon Steel, Alloy Steel (<35HRC)	Alloy Steel, Tool Steel (<48HRC)	Stainless Steel	Heat-resistant Alloys	Titanium Alloys
○	○	○	◎	○

◎ Most Suitable ○ Suitable

Recommended Cutting Data ※ P576

SN200-R4

4 Flutes, Corner Radius, with Unequal Tooth Pitch

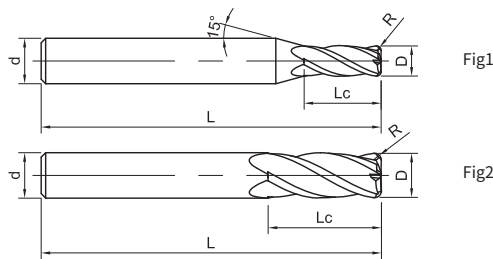

Please refer to page 167

» Continuation

Ordering Code	D	R	Lc	L	d	Figure No.	Stock
SN200-R4-06002	6	0.2	15	50	6	2	●
SN200-R4-06005	6	0.5	15	50	6	2	●
SN200-R4-06010	6	1	15	50	6	2	●
SN200-R4-06015	6	1.5	15	50	6	2	●
SN200-R4-06020	6	2	15	50	6	2	○
SN200-R4-08002	8	0.2	20	60	8	2	●
SN200-R4-08005	8	0.5	20	60	8	2	●
SN200-R4-08010A	8	1	20	60	8	2	●
SN200-R4-08015	8	1.5	20	60	8	2	●
SN200-R4-08020	8	2	20	60	8	2	●
SN200-R4-10002	10	0.2	25	75	10	2	●
SN200-R4-10005	10	0.5	25	75	10	2	●
SN200-R4-10010	10	1	22	72	10	2	○
SN200-R4-10010A	10	1	25	75	10	2	●
SN200-R4-10015	10	1.5	25	75	10	2	●
SN200-R4-10020	10	2	25	75	10	2	●
SN200-R4-10025	10	2.5	25	75	10	2	●
SN200-R4-12002	12	0.2	26	83	12	2	●
SN200-R4-12005	12	0.5	26	83	12	2	●

● Stock ○ Available upon Order

D	Tol
D ≤ 12	0 -0.03
D > 12	0 -0.04

Unit (mm)

Workpiece Material				
P		M	S	
1 2 3 4	5	1 2 3	1 2 3	4
Carbon Steel, Alloy Steel (<35HRC)	Alloy Steel, Tool Steel (<48HRC)	Stainless Steel	Heat-resistant Alloys	Titanium Alloys
○	○	○	◎	○

◎ Most Suitable ○ Suitable

Recommended Cutting Data ※ P576

SN200-R4

4 Flutes, Cornor Raidus, with Unequal Tooth Pitch

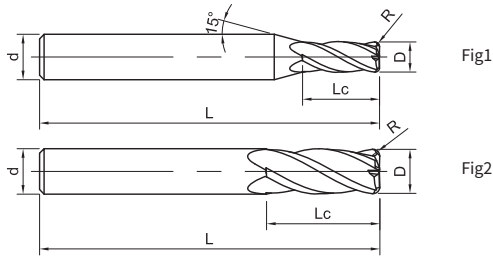

Please refer to page 167

» Continuation

Ordering Code	D	R	Lc	L	d	Figure No.	Stock
SN200-R4-12010	12	1	26	83	12	2	●
SN200-R4-12015	12	1.5	26	83	12	2	●
SN200-R4-12020	12	2	26	83	12	2	●
SN200-R4-12025	12	2.5	26	83	12	2	●
SN200-R4-12030	12	3	26	83	12	2	●
SN200-R4-16002	16	0.2	32	92	16	2	○
SN200-R4-16005	16	0.5	32	92	16	2	○
SN200-R4-16010	16	1	32	92	16	2	○
SN200-R4-16015	16	1.5	32	92	16	2	●
SN200-R4-16020	16	2	32	92	16	2	●
SN200-R4-16025	16	2.5	32	92	16	2	●
SN200-R4-16030	16	3	32	92	16	2	○
SN200-R4-16040	16	4	32	92	16	2	●
SN200-R4-18010	18	1	32	92	18	2	○
SN200-R4-20002	20	0.2	38	100	20	2	○
SN200-R4-20010	20	1	38	100	20	2	○
SN200-R4-20020	20	2	38	100	20	2	○
SN200-R4-20030	20	3	38	100	20	2	○

● Stock ○ Available upon Order

D	Tol
D ≤ 12	0 -0.03
D > 12	0 -0.04

Unit (mm)

Workpiece Material				
P		M	S	
1 2 3 4	5	1 2 3	1 2 3	4
Carbon Steel, Alloy Steel (<35HRC)	Alloy Steel, Tool Steel (<48HRC)	Stainless Steel	Heat-resistant Alloys	Titanium Alloys
○	○	○	◎	○

◎ Most Suitable ○ Suitable

Recommended Cutting Data ※ P576

SN200-RH4

4 Flutes, Corner Radius, with Unequal Tooth Pitch, Long Shank

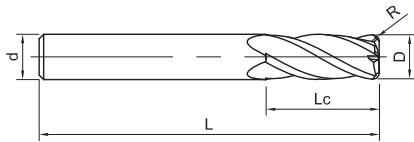

Fig1



Please refer to page 167

Ordering Code	D	R	Lc	L	d	Figure No.	Stock
SN200-RH4-08010	8	1	20	75	8	1	●
SN200-RH4-08020	8	2	20	75	8	1	●
SN200-RH4-10010	10	1	25	100	10	1	●
SN200-RH4-10020	10	2	25	100	10	1	●
SN200-RH4-12002	12	0.2	26	100	12	1	○
SN200-RH4-12010	12	1	26	100	12	1	●
SN200-RH4-12020	12	2	26	100	12	1	●
SN200-RH4-16010	16	1	32	110	16	1	○
SN200-RH4-16020	16	2	32	110	16	1	○
SN200-RH4-16030	16	3	32	110	16	1	○
SN200-RH4-16040	16	4	32	110	16	1	●

● Stock ○ Available upon Order

D	Tol
D ≤ 12	0 -0.03
D > 12	0 -0.04

Unit (mm)

Workpiece Material				
P		M	S	
1 2 3 4	5	1 2 3	1 2 3	4
Carbon Steel, Alloy Steel (<35HRC)	Alloy Steel, Tool Steel (<48HRC)	Stainless Steel	Heat-resistant Alloys	Titanium Alloys
○	○	○	○	○

○ Most Suitable ○ Suitable

Recommended Cutting Data ※ P576

SN200-B4

4 Flutes, Ballnose, with Unequal Tooth Pitch

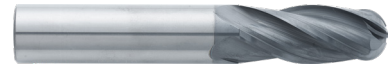
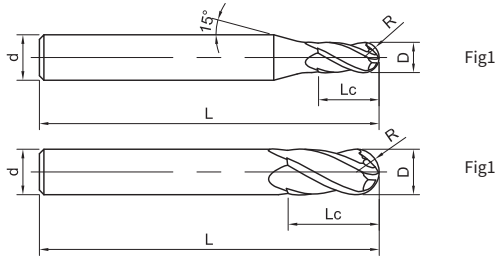

Please refer to page 167

Ordering Code	D	R	Lc	L	d	Figure No.	Stock
SN200-B4-02004	2	1	4	50	4	1	○
SN200-B4-62004	2	1	4	50	6	1	●
SN200-B4-03006	3	1.5	6	50	4	1	○
SN200-B4-63006	3	1.5	6	50	6	1	●
SN200-B4-04008	4	2	8	50	4	2	○
SN200-B4-64008	4	2	8	50	6	1	●
SN200-B4-05010	5	2.5	10	50	6	1	●
SN200-B4-06012	6	3	12	50	6	2	●
SN200-B4-08014	8	4	14	60	8	2	●
SN200-B4-10018	10	5	18	75	10	2	●
SN200-B4-12022	12	6	22	75	12	2	●

● Stock ○ Available upon Order

R	Tol
R<2	±0.010
2≤R<3	±0.015
R≥3	±0.020

Unit (mm)

Workpiece Material				
P		M	S	
1 2 3 4	5	1 2 3	1 2 3	4
Carbon Steel, Alloy Steel (<35HRC)	Alloy Steel, Tool Steel (<48HRC)	Stainless Steel	Heat-resistant Alloys	Titanium Alloys
○	○	○	○	○

○ Most Suitable ○ Suitable

Recommended Cutting Data ※ P577

SN200-BH4

4 Flutes, Ballnose, with Unequal Tooth Pitch, Long Shank

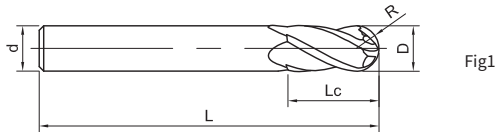

Fig1



Please refer to page 167

Ordering Code	D	R	Lc	L	d	Figure No.	Stock
SN200-BH4-08014	8	4	14	75	8	1	●
SN200-BH4-10018	10	5	18	100	10	1	●
SN200-BH4-12022	12	6	22	100	12	1	●

● Stock ○ Available upon Order

R	Tol
R ≥ 3	±0.020

Unit (mm)

Workpiece Material				
P		M	S	
1 2 3 4	5	1 2 3	1 2 3	4
Carbon Steel, Alloy Steel (<35HRC)	Alloy Steel, Tool Steel (<48HRC)	Stainless Steel	Heat-resistant Alloys	Titanium Alloys
○	○	○	◎	○

◎ Most Suitable ○ Suitable

Recommended Cutting Data ※ P577

SD200-CN

8/12 Flutes, Rhombic Teeth

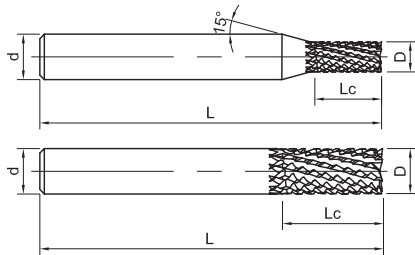

Fig1

Fig2



Please refer to page 167

Ordering Code	D	Lc	L	d	Flute	Figure No.	Stock
SD200-CN8-02008	2	8	50	4	8	1	●
SD200-CN8-04010	4	10	50	4	8	2	●
SD200-CN12-06015	6	15	60	6	12	2	●
SD200-CN12-08020	8	20	60	8	12	2	●
SD200-CN12-10025	10	25	75	10	12	2	●
SD200-CN12-12030	12	30	85	12	12	2	○

● Stock ○ Available upon Order

D	Tol
4 ≤ D ≤ 12	0 -0.04

Unit (mm)

Workpiece Material					
P		M	N		
1234	5	123	123	4	5
Carbon Steel, Alloy Steel (<35HRC)	Alloy Steel, Tool Steel (<48HRC)	Stainless Steel	Aluminium Alloys	Copper Alloys	Carbon fiber, glass fiber, composite material
					◎

◎ Most Suitable ○ Suitable

Recommended Cutting Data ※ P578

SH160-S2

2 Flutes, Standard Length, Square

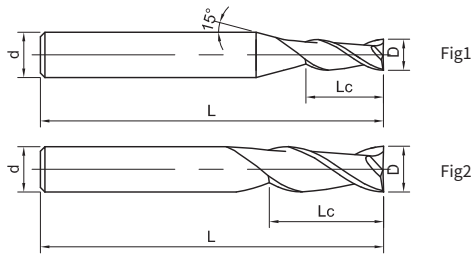

Please refer to page 167

Ordering Code	D	Lc	L	d	Figure No.	Stock
SH160-S2-00501	0.5	1.5	50	4	1	●
SH160-S2-01003	1	3	50	4	1	●
SH160-S2-01504	1.5	4	50	4	1	●
SH160-S2-02006	2	6	50	4	1	●
SH160-S2-02508	2.5	8	50	4	1	●
SH160-S2-03009	3	9	50	4	1	●
SH160-S2-63009	3	9	50	6	1	●
SH160-S2-04010	4	10	50	4	2	●
SH160-S2-64010	4	10	50	6	1	●
SH160-S2-05013	5	13	50	6	1	●
SH160-S2-06015	6	15	50	6	2	●

● Stock ○ Available upon Order

D	Tol
D ≤ 12	0 -0.02
D > 12	0 -0.03

Unit (mm)

Workpiece Material					
P			H		
1234	5	6	1	2	34
Carbon Steel, Alloy Steel (<35HRC)	Alloy Steel (≤48HRC)	PH, Ferrite, Martensite Steel (<35HRC)	Hardened Steel (45-55HRC)	Hardened Steel (55-60HRC)	Hardened Steel (>60HRC)
			◎		

◎ Most Suitable ○ Suitable

Recommended Cutting Data ※ P579

SH160-S2

2 Flutes, Standard Length, Square

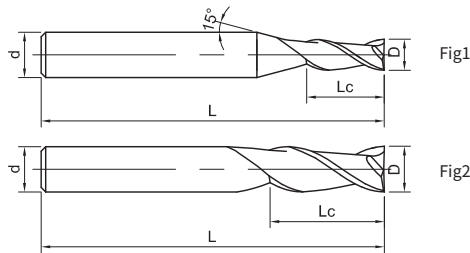

Please refer to page 167

» Continuation

Ordering Code	D	Lc	L	d	Figure No.	Stock
SH160-S2-07020	7	20	60	8	1	●
SH160-S2-08020	8	20	60	8	2	●
SH160-S2-09023	9	23	75	10	1	○
SH160-S2-10025	10	25	75	10	2	●
SH160-S2-11028	11	28	75	12	1	●
SH160-S2-12030	12	30	75	12	2	○
SH160-S2-13032	13	32	100	14	1	●
SH160-S2-14034	14	34	100	14	2	●
SH160-S2-16036	16	36	100	16	2	○
SH160-S2-18040	18	40	100	18	2	○
SH160-S2-20045	20	45	100	20	2	○

● Stock ○ Available upon Order

D	Tol
D ≤ 12	0 -0.02
D > 12	0 -0.03

Unit (mm)

Workpiece Material

P			H		
1234	5	6	1	2	34
Carbon Steel, Alloy Steel (<35HRC)	Alloy Steel (≤48HRC)	PH, Ferrite, Martensite Steel (<35HRC)	Hardened Steel (45-55HRC)	Hardened Steel (55-60HRC)	Hardened Steel (>60HRC)
			◎		

◎ Most Suitable ○ Suitable

Recommended Cutting Data ※ P579

SH160-S4

4 Flutes, Standard Length, Square

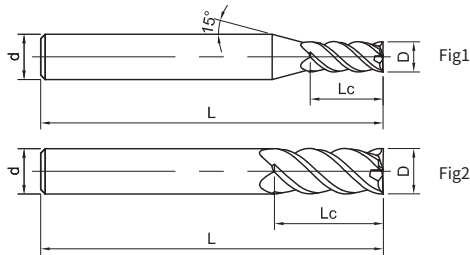

Please refer to page 167

Ordering Code	D	Lc	L	d	Figure No.	Stock
SH160-S4-01003	1	3	50	4	1	●
SH160-S4-01504	1.5	4	50	4	1	●
SH160-S4-02006	2	6	50	4	1	●
SH160-S4-02508	2.5	8	50	4	1	●
SH160-S4-03009	3	9	50	4	1	●
SH160-S4-63009	3	9	50	6	1	●
SH160-S4-04010	4	10	50	4	2	●
SH160-S4-64010	4	10	50	6	1	●
SH160-S4-05013	5	13	50	6	1	●
SH160-S4-06015	6	15	50	6	2	●
SH160-S4-07020	7	20	60	8	1	●

● Stock ○ Available upon Order

D	Tol
D ≤ 12	0 -0.02
D > 12	0 -0.03

Unit (mm)

Workpiece Material

P			H		
1234	5	6	1	2	34
Carbon Steel, Alloy Steel (<35HRC)	Alloy Steel (≤48HRC)	PH, Ferrite, Martensite Steel (<35HRC)	Hardened Steel (45-55HRC)	Hardened Steel (55-60HRC)	Hardened Steel (>60HRC)
			◎		

◎ Most Suitable ○ Suitable

Recommended Cutting Data ※ P579

SH160-S4

4 Flutes, Standard Length, Square

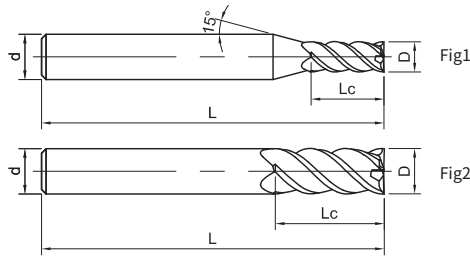

Please refer to page 167

» Continuation

Ordering Code	D	Lc	L	d	Figure No.	Stock
SH160-S4-08020	8	20	60	8	2	●
SH160-S4-09023	9	23	75	10	1	●
SH160-S4-10025	10	25	75	10	2	●
SH160-S4-11028	11	28	75	12	1	●
SH160-S4-12030	12	30	75	12	2	●
SH160-S4-13032	13	32	100	14	1	○
SH160-S4-14034	14	34	100	14	2	●
SH160-S4-15036	15	36	100	16	1	●
SH160-S4-16036	16	36	100	16	2	●
SH160-S4-18040	18	40	100	18	2	○
SH160-S4-20045	20	45	100	20	2	●

● Stock ○ Available upon Order

D	Tol
D ≤ 12	0 -0.02
D > 12	0 -0.03

Unit (mm)

Workpiece Material

P			H		
1234	5	6	1	2	34
Carbon Steel, Alloy Steel (<35HRC)	Alloy Steel (≤48HRC)	PH, Ferrite, Martensite Steel (<35HRC)	Hardened Steel (45-55HRC)	Hardened Steel (55-60HRC)	Hardened Steel (>60HRC)
			○		

○ Most Suitable ○ Suitable

Recommended Cutting Data ※ P579

SH160-SH4

4 Flutes, Long Shank Length, Square

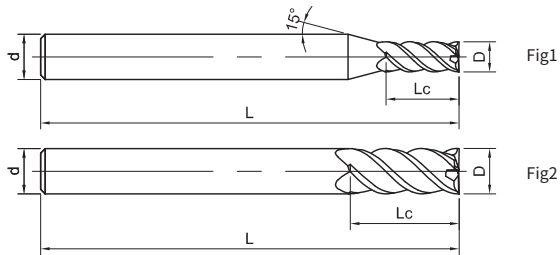

Please refer to page 167

Ordering Code	D	Lc	L	d	Figure No.	Stock
SH160-SH4-03012	3	12	75	4	1	●
SH160-SH4-04015	4	15	75	4	2	●
SH160-SH4-06020	6	20	100	6	2	●
SH160-SH4-08025	8	25	100	8	2	●
SH160-SH4-10030	10	30	100	10	2	●
SH160-SH4-12035	12	35	100	12	2	●

● Stock ○ Available upon Order

D	Tol
D ≤ 12	0 -0.02
D > 12	0 -0.03

Unit (mm)

Workpiece Material					
P			H		
1234	5	6	1	2	34
Carbon Steel, Alloy Steel (<35HRC)	Alloy Steel (≤48HRC)	PH, Ferrite, Martensite Steel (<35HRC)	Hardened Steel (45-55HRC)	Hardened Steel (55-60HRC)	Hardened Steel (>60HRC)
			○		

○ Most Suitable ○ Suitable

Recommended Cutting Data ※ P579

SH160-S6

6 Flutes, Standard Length, Square

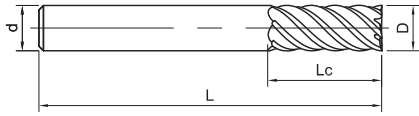

Fig1



Please refer to page 167

Ordering Code	D	Lc	L	d	Figure No.	Stock
SH160-S6-06015	6	15	50	6	1	●
SH160-S6-08020	8	20	60	8	1	●
SH160-S6-10025	10	25	75	10	1	●
SH160-S6-12030	12	30	75	12	1	●
SH160-S6-16036	16	36	100	16	1	○
SH160-S6-20045	20	45	100	20	1	●

● Stock ○ Available upon Order

D	Tol
D ≤ 12	0 -0.02
D > 12	0 -0.03

Unit (mm)

Workpiece Material					
P			H		
1234	5	6	1	2	34
Carbon Steel, Alloy Steel (<35HRC)	Alloy Steel (≤48HRC)	PH, Ferrite, Martensite Steel (<35HRC)	Hardened Steel (45-55HRC)	Hardened Steel (55-60HRC)	Hardened Steel (>60HRC)
			○		

○ Most Suitable ○ Suitable

Recommended Cutting Data ※ P579

SH160-R2

2 Flutes, Corner Radius

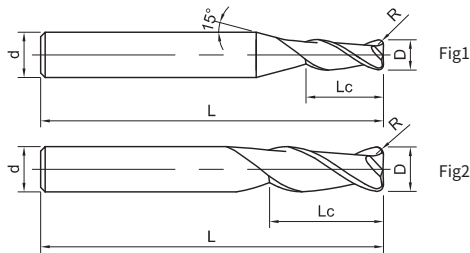

Please refer to page 167

Ordering Code	D	Lc	R	L	d	Figure No.	Stock
SH160-R2-02002	2	6	0.2	50	4	1	●
SH160-R2-02003	2	6	0.3	50	4	1	●
SH160-R2-03003	3	9	0.3	50	4	1	●
SH160-R2-03005	3	9	0.5	50	4	1	●
SH160-R2-04003	4	10	0.3	50	4	2	○
SH160-R2-04005	4	10	0.5	50	4	2	●
SH160-R2-04010	4	10	1	50	4	2	○
SH160-R2-05003	5	13	0.3	50	6	1	○
SH160-R2-05005	5	13	0.5	50	6	1	○
SH160-R2-05010	5	13	1	50	6	1	○
SH160-R2-06003	6	15	0.3	50	6	2	●
SH160-R2-06005	6	15	0.5	50	6	2	●

● Stock ○ Available upon Order

D	Tol
D ≤ 12	0 -0.02
D > 12	0 -0.03

Unit (mm)

Workpiece Material					
P			H		
1234	5	6	1	2	34
Carbon Steel, Alloy Steel (<35HRC)	Alloy Steel (≤48HRC)	PH, Ferrite, Martensite Steel (<35HRC)	Hardened Steel (45-55HRC)	Hardened Steel (55-60HRC)	Hardened Steel (>60HRC)
			○		

○ Most Suitable ○ Suitable

Recommended Cutting Data ※ P579

SH160-R2

2 Flutes, Corner Radius

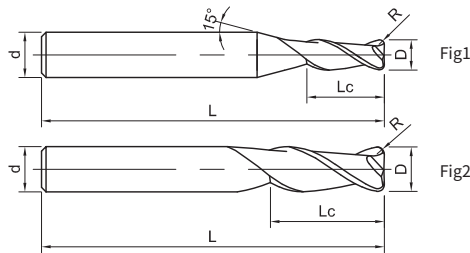

Please refer to page 167

» Continuation

Ordering Code	D	Lc	R	L	d	Figure No.	Stock
SH160-R2-06010	6	15	1	50	6	2	●
SH160-R2-08005	8	20	0.5	60	8	2	●
SH160-R2-08010	8	20	1	60	8	2	○
SH160-R2-10005	10	25	0.5	75	10	2	○
SH160-R2-10010	10	25	1	75	10	2	○
SH160-R2-10015	10	25	1.5	75	10	2	○
SH160-R2-10020	10	25	2	75	10	2	●
SH160-R2-12005	12	30	0.5	75	12	2	●
SH160-R2-12010	12	30	1	75	12	2	○
SH160-R2-12015	12	30	1.5	75	12	2	○
SH160-R2-12020	12	30	2	75	12	2	○

● Stock ○ Available upon Order

D	Tol
D ≤ 12	0 -0.02
D > 12	0 -0.03

Unit (mm)

Workpiece Material

P			H		
1234	5	6	1	2	34
Carbon Steel, Alloy Steel (<35HRC)	Alloy Steel (≤48HRC)	PH, Ferrite, Martensite Steel (<35HRC)	Hardened Steel (45-55HRC)	Hardened Steel (55-60HRC)	Hardened Steel (>60HRC)
			○		

○ Most Suitable ○ Suitable

Recommended Cutting Data ※ P579

SH160-R4

4 Flutes, Corner Radius

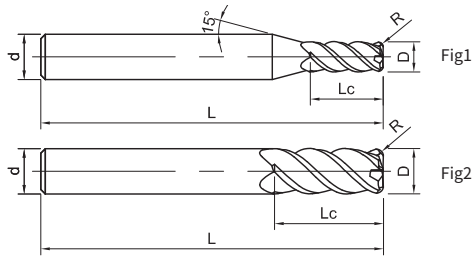

Please refer to page 167

Ordering Code	D	Lc	R	L	d	Figure No.	Stock
SH160-R4-01002	1	3	0.2	50	4	1	●
SH160-R4-02002	2	6	0.2	50	4	1	●
SH160-R4-02005	2	6	0.5	50	4	1	●
SH160-R4-03002	3	9	0.2	50	4	1	●
SH160-R4-03003	3	9	0.3	50	4	1	●
SH160-R4-03005	3	9	0.5	50	4	1	●
SH160-R4-63003	3	8	0.3	50	6	1	●
SH160-R4-63005	3	8	0.5	50	6	1	●
SH160-R4-04002	4	10	0.2	50	4	2	●
SH160-R4-04003	4	10	0.3	50	4	2	●
SH160-R4-04005	4	10	0.5	50	4	2	●
SH160-R4-04010	4	10	1	50	4	2	●

● Stock ○ Available upon Order

D	Tol
D ≤ 12	0 -0.02
D > 12	0 -0.03

Unit (mm)

Workpiece Material					
P			H		
1234	5	6	1	2	34
Carbon Steel, Alloy Steel (<35HRC)	Alloy Steel (≤48HRC)	PH, Ferrite, Martensite Steel (<35HRC)	Hardened Steel (45-55HRC)	Hardened Steel (55-60HRC)	Hardened Steel (>60HRC)
			◎		

◎ Most Suitable ○ Suitable

Recommended Cutting Data ※ P579

SH160-R4

4 Flutes, Corner Radius

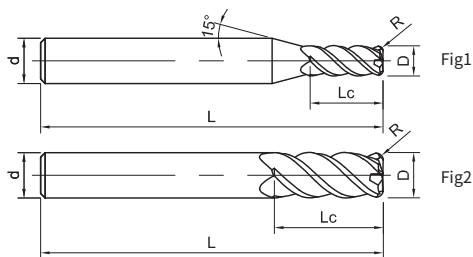

Please refer to page 167

» Continuation

Ordering Code	D	Lc	R	L	d	Figure No.	Stock
SH160-R4-64002	4	10	0.2	50	6	1	●
SH160-R4-64003	4	10	0.3	50	6	1	●
SH160-R4-64005	4	10	0.5	50	6	1	●
SH160-R4-64010	4	10	1	50	6	1	●
SH160-R4-05003	5	13	0.3	50	6	1	○
SH160-R4-05005	5	13	0.5	50	6	1	●
SH160-R4-05010	5	13	1	50	6	1	●
SH160-R4-06002	6	15	0.2	50	6	2	●
SH160-R4-06003	6	15	0.3	50	6	2	●
SH160-R4-06005	6	15	0.5	50	6	2	●
SH160-R4-06010	6	15	1	50	6	2	●
SH160-R4-08002	8	20	0.2	60	8	2	●

● Stock ○ Available upon Order

D	Tol
D ≤ 12	0 -0.02
D > 12	0 -0.03

Unit (mm)

Workpiece Material					
P			H		
1234	5	6	1	2	34
Carbon Steel, Alloy Steel (<35HRC)	Alloy Steel (≤48HRC)	PH, Ferrite, Martensite Steel (<35HRC)	Hardened Steel (45-55HRC)	Hardened Steel (55-60HRC)	Hardened Steel (>60HRC)
			◎		

◎ Most Suitable ○ Suitable

Recommended Cutting Data ※ P579

SH160-R4

4 Flutes, Corner Radius

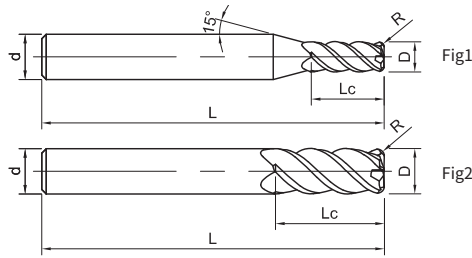

Please refer to page 167

» Continuation

Ordering Code	D	Lc	R	L	d	Figure No.	Stock
SH160-R4-08003	8	20	0.3	60	8	2	●
SH160-R4-08005	8	20	0.5	60	8	2	●
SH160-R4-08010	8	20	1	60	8	2	●
SH160-R4-10005	10	25	0.5	75	10	2	●
SH160-R4-10010	10	25	1	75	10	2	●
SH160-R4-10015	10	25	1.5	75	10	2	●
SH160-R4-10020	10	25	2	75	10	2	●
SH160-R4-12003	12	30	0.3	75	12	2	●
SH160-R4-12005	12	30	0.5	75	12	2	●
SH160-R4-12010	12	30	1	75	12	2	●
SH160-R4-12015	12	30	1.5	75	12	2	●
SH160-R4-12020	12	30	2	75	12	2	●

● Stock ○ Available upon Order

D	Tol
D ≤ 12	0 -0.02
D > 12	0 -0.03

Unit (mm)

Workpiece Material					
P			H		
1234	5	6	1	2	34
Carbon Steel, Alloy Steel (<35HRC)	Alloy Steel (≤48HRC)	PH, Ferrite, Martensite Steel (<35HRC)	Hardened Steel (45-55HRC)	Hardened Steel (55-60HRC)	Hardened Steel (>60HRC)
			◎		

◎ Most Suitable ○ Suitable

Recommended Cutting Data ※ P579

SH160-RH4

4 Flutes, Corner Radius, with Long Shank Length

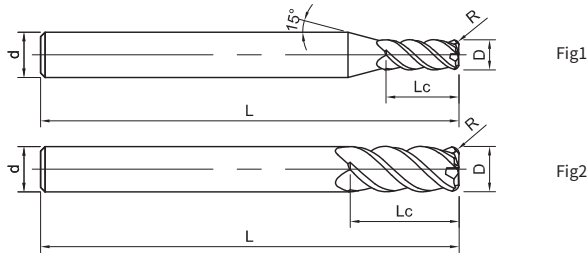

Please refer to page 167

Ordering Code	D	Lc	R	L	d	Figure No.	Stock
SH160-RH4-04005	4	10	0.5	75	4	2	●
SH160-RH4-06005	6	15	0.5	75	6	2	●
SH160-RH4-06010	6	15	1	75	6	2	●
SH160-RH4-08005	8	20	0.5	100	8	2	●
SH160-RH4-08010	8	20	1	100	8	2	●
SH160-RH4-10005	10	25	0.5	100	10	2	●
SH160-RH4-10010	10	25	1	100	10	2	●
SH160-RH4-12005	12	30	0.5	100	12	2	●
SH160-RH4-12010	12	30	1	100	12	2	●

● Stock ○ Available upon Order

D	Tol
D ≤ 12	0 -0.02
D > 12	0 -0.03

Unit (mm)

Workpiece Material					
P			H		
1234	5	6	1	2	34
Carbon Steel, Alloy Steel (<35HRC)	Alloy Steel (≤48HRC)	PH, Ferrite, Martensite Steel (<35HRC)	Hardened Steel (45-55HRC)	Hardened Steel (55-60HRC)	Hardened Steel (>60HRC)
			○		

○ Most Suitable ○ Suitable

Recommended Cutting Data ※ P579

SH160-B2

2 Flutes, Ballnose

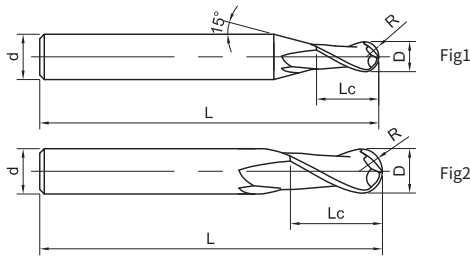

Please refer to page 167

Ordering Code	D	R	Lc	L	d	Figure No.	Stock
SH160-B2-00501	0.5	0.25	1	50	4	1	●
SH160-B2-01002	1	0.5	2	50	4	1	●
SH160-B2-01503	1.5	0.75	3	50	4	1	●
SH160-B2-02004	2	1	4	50	4	1	●
SH160-B2-02505	2.5	1.25	5	50	4	1	●
SH160-B2-03006	3	1.5	6	50	4	1	●
SH160-B2-04008	4	2	8	50	4	2	●
SH160-B2-05010	5	2.5	10	50	6	1	●
SH160-B2-06012	6	3	12	50	6	2	●
SH160-B2-07014	7	3.5	14	60	8	1	●
SH160-B2-08014	8	4	14	60	8	2	●
SH160-B2-09016	9	4.5	16	75	10	1	●

● Stock ○ Available upon Order

R	Tol
R ≤ 1.5	0 -0.01
1.5 < R < 3	0 -0.015
R ≥ 3	0 -0.02

Unit (mm)

Workpiece Material					
P			H		
1234	5	6	1	2	34
Carbon Steel, Alloy Steel (<35HRC)	Alloy Steel (≤48HRC)	PH, Ferrite, Martensite Steel (<35HRC)	Hardened Steel (45-55HRC)	Hardened Steel (55-60HRC)	Hardened Steel (>60HRC)
			◎		

◎ Most Suitable ○ Suitable

Recommended Cutting Data ※ P579

SH160-B2

2 Flutes, Ballnose

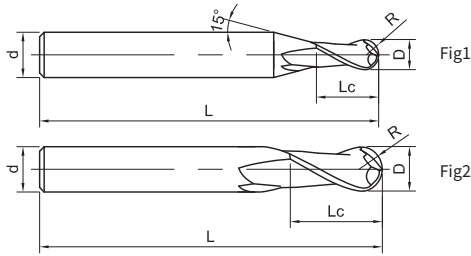

Please refer to page 167

» Continuation

Ordering Code	D	R	Lc	L	d	Figure No.	Stock
SH160-B2-10018	10	5	18	75	10	2	●
SH160-B2-11020	11	5.5	20	75	12	1	●
SH160-B2-12022	12	6	22	75	12	2	●
SH160-B2-14024	14	7	24	100	14	2	●
SH160-B2-16026	16	8	26	100	16	2	●
SH160-B2-20030	20	10	30	100	20	2	●

● Stock ○ Available upon Order

R	Tol
R ≤ 1.5	0 -0.01
1.5 < R < 3	0 -0.015
R ≥ 3	0 -0.02

Unit (mm)

Workpiece Material					
P			H		
1234	5	6	1	2	34
Carbon Steel, Alloy Steel (<35HRC)	Alloy Steel (≤48HRC)	PH, Ferrite, Martensite Steel (<35HRC)	Hardened Steel (45-55HRC)	Hardened Steel (55-60HRC)	Hardened Steel (>60HRC)
			○		

○ Most Suitable ○ Suitable

Recommended Cutting Data ※ P579

SH160-BH2

2 Flutes, Ballnose, with Long Shank Length

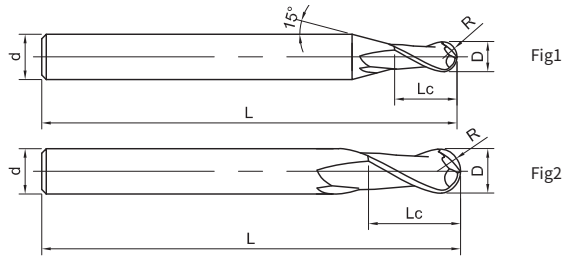

Please refer to page 167

Ordering Code	D	R	Lc	L	d	Figure No.	Stock
SH160-BH2-04008	4	2	8	75	4	2	●
SH160-BH2-06012	6	3	12	100	6	2	●
SH160-BH2-08014	8	4	14	100	8	2	●
SH160-BH2-10018	10	5	18	100	10	2	●
SH160-BH2-12024	12	6	24	100	12	2	●

● Stock ○ Available upon Order

R	Tol
$R \leq 1.5$	$\begin{matrix} 0 \\ -0.01 \end{matrix}$
$1.5 < R < 3$	$\begin{matrix} 0 \\ -0.015 \end{matrix}$
$R \geq 3$	$\begin{matrix} 0 \\ -0.02 \end{matrix}$

Unit (mm)

Workpiece Material					
P			H		
1234	5	6	1	2	34
Carbon Steel, Alloy Steel (<35HRC)	Alloy Steel (≤48HRC)	PH, Ferrite, Martensite Steel (<35HRC)	Hardened Steel (45-55HRC)	Hardened Steel (55-60HRC)	Hardened Steel (>60HRC)
			○		

○ Most Suitable ○ Suitable

Recommended Cutting Data ※ P579

SH160-B4

4 Flutes, Ballnose

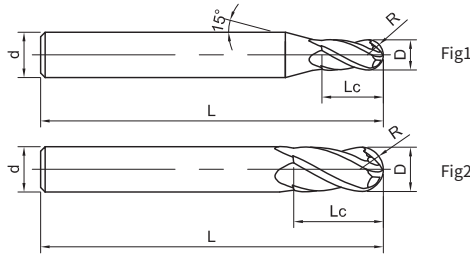

Please refer to page 167

Ordering Code	D	R	Lc	L	d	Figure No.	Stock
SH160-B4-02004	2	1	4	50	4	1	●
SH160-B4-03006	3	1.5	6	50	4	1	●
SH160-B4-04008	4	2	8	50	4	2	●
SH160-B4-05010	5	2.5	10	50	6	1	●
SH160-B4-06012	6	3	12	50	6	2	●
SH160-B4-07014	7	3.5	14	60	8	1	●
SH160-B4-08014	8	4	14	60	8	2	●
SH160-B4-09016	9	4.5	16	75	10	1	●
SH160-B4-10018	10	5	18	75	10	2	●
SH160-B4-11020	11	5.5	20	75	12	1	●
SH160-B4-12022	12	6	22	75	12	2	●
SH160-B4-16026	16	8	26	100	16	2	○

● Stock ○ Available upon Order

R	Tol
R ≤ 1.5	0 -0.01
1.5 < R < 3	0 -0.015
R ≥ 3	0 -0.02

Unit (mm)

Workpiece Material					
P			H		
1234	5	6	1	2	34
Carbon Steel, Alloy Steel (<35HRC)	Alloy Steel (≤48HRC)	PH, Ferrite, Martensite Steel (<35HRC)	Hardened Steel (45-55HRC)	Hardened Steel (55-60HRC)	Hardened Steel (>60HRC)
			◎		

◎ Most Suitable ○ Suitable

Recommended Cutting Data ※ P579

SH260-S2-H

2 Flutes, Standard Length, Square

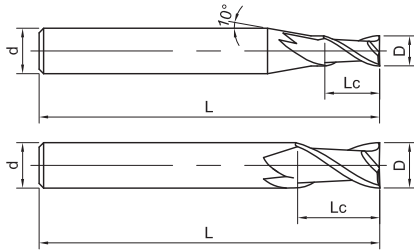

Fig1

Fig2



Please refer to page 167

Ordering Code	D	Lc	L	d	Figure No.	Stock
SH260-S2-1-2.5-H	1	2.5	50	4	1	●
SH260-S2-1.5-6-H	1.5	6	50	4	1	●
SH260-S2-2-5-H	2	5	50	4	1	●
SH260-S2-3-7.5-H	3	7.5	50	4	1	●
SH260-S2-4-10-H	4	10	50	4	2	●
SH260-S2-5-12.5-H	5	12.5	50	6	1	●
SH260-S2-6-15-H	6	15	50	6	2	●
SH260-S2-8-20-H	8	20	60	8	2	●
SH260-S2-10-25-H	10	25	75	10	2	●
SH260-S2-12-30-H	12	30	75	12	2	●

● Stock ○ Available upon Order

D	Tol
D ≤ 6	0 -0.01
D > 6	0 -0.02

Unit (mm)

Workpiece Material					
P			H		
1	2	3	4	5	6
Carbon Steel, Alloy Steel (< 35HRC)				Alloy Steel (35-48HRC)	PH, Ferrite, Martensite Steel (< 35HRC)
					Hardened Steel (45-55HRC)
					Hardened Steel (55-60HRC)
					Hardened Steel (> 60HRC)
○				◎	

◎ Most Suitable ○ Suitable

Recommended Cutting Data ※ P580

SH260-SN2-H

2 Flutes, Long Neck, Square

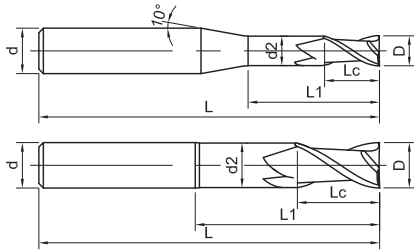

Fig1

Fig2



Please refer to page 167

Ordering Code	D	Lc	d2	L1	L	d	Figure No.	Stock
SH260-SN2-0.6-5.5-H	0.6	0.9	0.57	5.5	50	4	1	●
SH260-SN2-0.8-2.5-H	0.8	1.2	0.76	2.5	50	4	1	●
SH260-SN2-0.8-5-H	0.8	1.2	0.76	5	50	4	1	●
SH260-SN2-0.8-7-H	0.8	1.2	0.76	7	50	4	1	●
SH260-SN2-1-3-H	1	1.5	0.96	3	50	4	1	●
SH260-SN2-1-4-H	1	1.5	0.96	4	50	4	1	●
SH260-SN2-1-6-H	1	1.5	0.96	6	50	4	1	●
SH260-SN2-1-8-H	1	1.5	0.96	8	50	4	1	●
SH260-SN2-1-10-H	1	1.5	0.96	10	50	4	1	●
SH260-SN2-1.5-6-H	1.5	2.5	1.44	6	50	4	1	●
SH260-SN2-1.5-10-H	1.5	2.5	1.44	10	50	4	1	●
SH260-SN2-2-6-H	2	3	1.92	6	50	4	1	●
SH260-SN2-2-8-H	2	3	1.92	8	50	4	1	●

● Stock ○ Available upon Order

D	Tol
D ≤ 6	0 -0.01
D > 6	0 -0.02

Unit (mm)

Workpiece Material

P			H		
1	2	3	4	5	6
Carbon Steel, Alloy Steel (< 35HRC)	Alloy Steel (35-48HRC)	PH, Ferrite, Martensite Steel (< 35HRC)	Hardened Steel (45-55HRC)	Hardened Steel (55-60HRC)	Hardened Steel (> 60HRC)
○	○	○	○	○	○

○ Most Suitable ○ Suitable

Recommended Cutting Data ※ P580

SH260-SN2-H

2 Flutes, Long Neck, Square

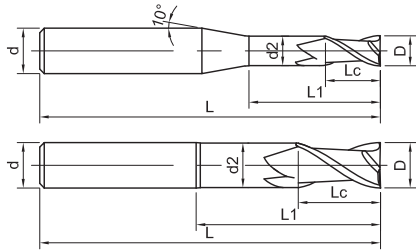

Fig1

Fig2



Please refer to page 167

» Continuation

Ordering Code	D	Lc	d2	L1	L	d	Figure No.	Stock
SH260-SN2-2-10-H	2	3	1.92	10	50	4	1	●
SH260-SN2-2-12-H	2	3	1.92	12	50	4	1	●
SH260-SN2-2.5-13-H	2.5	3.8	2.4	13	50	4	1	●
SH260-SN2-3-9-H	3	4.5	2.88	9	50	4	1	●
SH260-SN2-3-18-H	3	4.5	2.88	18	50	4	1	●
SH260-SN2-4-12-H-6	4	6	3.8	12	60	6	1	●
SH260-SN2-4-24-H-6	4	6	3.8	24	60	6	1	●
SH260-SN2-5-15-H	5	7.5	4.8	15	60	6	1	●
SH260-SN2-5-25-H	5	7.5	4.8	25	75	6	1	●
SH260-SN2-6-18-H	6	9	5.8	18	75	6	2	●
SH260-SN2-6-36-H	6	9	5.8	36	75	6	2	●

● Stock ○ Available upon Order

D	Tol
D ≤ 6	0 -0.01
D > 6	0 -0.02

Unit (mm)

Workpiece Material					
P			H		
1	2	3	4	5	6
Carbon Steel, Alloy Steel (< 35HRC)	Alloy Steel (35-48HRC)	PH, Ferrite, Martensite Steel (< 35HRC)	Hardened Steel (45-55HRC)	Hardened Steel (55-60HRC)	Hardened Steel (> 60HRC)
○	○	○	○	○	○

○ Most Suitable ○ Suitable

Recommended Cutting Data ※ P580

SH260-S4-H

4 Flutes, Standard Length, Square

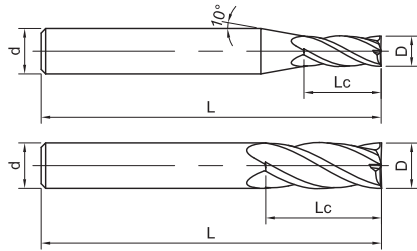

Fig1

Fig2



Please refer to page 167

Ordering Code	D	Lc	L	d	Figure No.	Stock
SH260-S4-1-2.5-H	1	2.5	50	4	1	●
SH260-S4-1-2.5-H-6	1	2.5	50	6	1	●
SH260-S4-1.5-4-H	1.5	4	50	4	1	●
SH260-S4-2-5-H	2	5	50	4	1	●
SH260-S4-2.5-6-H	2.5	6	50	4	1	●
SH260-S4-3-8-H	3	8	50	4	1	●
SH260-S4-3-8-H-3	3	8	50	3	2	●
SH260-S4-3-9-H-6	3	9	50	6	1	●
SH260-S4-4-10-H	4	10	50	4	2	●
SH260-S4-5-13-H	5	13	50	6	1	●
SH260-S4-6-15-H	6	15	50	6	2	●
SH260-S4-8-20-H	8	20	60	8	2	●
SH260-S4-10-25-H	10	25	75	10	2	●
SH260-S4-10-30-H	10	30	75	10	2	●
SH260-S4-12-30-H	12	30	75	12	2	●
SH260-S4-12-36-H	12	36	75	12	2	●
SH260-S4-14-35-H	14	35	100	14	2	●
SH260-S4-16-40-H	16	40	100	16	2	●
SH260-S4-20-50-H	20	50	100	20	2	●

● Stock ○ Available upon Order

D	Tol
D ≤ 6	0 -0.01
6 < D ≤ 12	0 -0.02
D > 12	0 -0.03

Unit (mm)

Workpiece Material

P			H		
1 2 3 4	5	6	1	2	3 4
Carbon Steel, Alloy Steel (< 35HRC)	Alloy Steel (35-48HRC)	PH, Ferrite, Martensite Steel (< 35HRC)	Hardened Steel (45-55HRC)	Hardened Steel (55-60HRC)	Hardened Steel (> 60HRC)
○	◎		◎	◎	○

◎ Most Suitable ○ Suitable

Recommended Cutting Data ※ P581

SH260-S4A-H

4 Flutes, Standard Length, Square, 45° Helix Angle

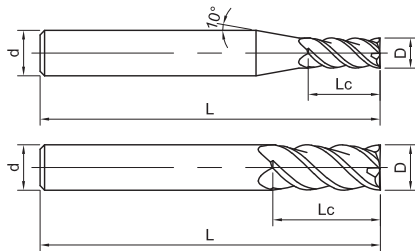

Fig1

Fig2



Please refer to page 167

Ordering Code	D	Lc	L	d	Figure No.	Stock
SH260-S4A-1-3-H	1	3	50	4	1	●
SH260-S4A-1.5-4-H	1.5	4	50	4	1	●
SH260-S4A-2-5-H	2	5	50	4	1	●
SH260-S4A-2.5-6-H	2.5	6	50	4	1	●
SH260-S4A-3-8-H	3	8	50	4	1	●
SH260-S4A-4-10-H	4	10	50	4	2	●
SH260-S4A-5-13-H	5	13	50	6	1	●
SH260-S4A-6-15-H	6	15	50	6	2	●
SH260-S4A-8-20-H	8	20	60	8	2	●
SH260-S4A-10-25-H	10	25	75	10	2	●
SH260-S4A-10-30-H	10	30	75	10	2	●
SH260-S4A-12-30-H	12	30	75	12	2	●
SH260-S4A-16-45-H	16	45	100	16	2	●
SH260-S4A-20-50-H	20	50	100	20	2	○

● Stock ○ Available upon Order

D	Tol
D ≤ 6	0 -0.01
6 < D ≤ 12	0 -0.02
D > 12	0 -0.03

Unit (mm)

Workpiece Material					
P			H		
1 2 3 4	5	6	1	2	3 4
Carbon Steel, Alloy Steel (< 35HRC)	Alloy Steel (35-48HRC)	PH, Ferrite, Martensite Steel (< 35HRC)	Hardened Steel (45-55HRC)	Hardened Steel (55-60HRC)	Hardened Steel (> 60HRC)
○	◎		◎	◎	○

◎ Most Suitable ○ Suitable

Recommended Cutting Data ※ P581

SH260-SH4-H

4 Flutes, Long Shank Length, Square

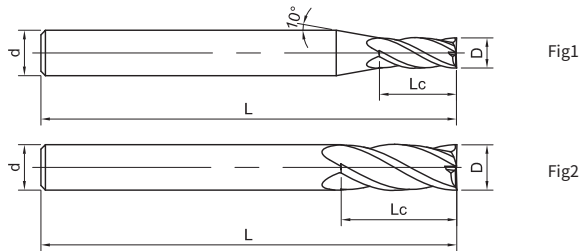

Please refer to page 167

Ordering Code	D	Lc	L	d	Figure No.	Stock
SH260-SH4-1-60-H	1	2.5	60	4	1	●
SH260-SH4-2-60-H	2	5	60	4	1	●
SH260-SH4-3-60-H	3	8	60	4	1	●
SH260-SH4-3-60-H-6	3	8	60	6	1	●
SH260-SH4-4-60-H	4	10	60	4	2	●
SH260-SH4-4-75-H	4	10	75	4	2	●
SH260-SH4-4-60-H-6	4	10	60	6	1	●
SH260-SH4-4-75-H-6	4	10	75	6	1	●
SH260-SH4-5-60-H	5	13	60	6	1	●
SH260-SH4-6-60-H	6	15	60	6	2	●
SH260-SH4-6-75-H	6	15	75	6	2	●
SH260-SH4-8-75-H	8	20	75	8	2	●
SH260-SH4-8-100-H	8	20	100	8	2	●
SH260-SH4-10-100-H	10	25	100	10	2	●
SH260-SH4-12-100-H	12	30	100	12	2	●
SH260-SH4-12-120-H	12	30	120	12	2	●
SH260-SH4-16-150-H	16	40	150	16	2	●
SH260-SH4-20-150-H	20	50	150	20	2	○

● Stock ○ Available upon Order

D	Tol
D ≤ 6	0 -0.01
6 < D ≤ 12	0 -0.02
D > 12	0 -0.03

Unit (mm)

Workpiece Material					
P			H		
1	2	3	4	5	6
Carbon Steel, Alloy Steel (< 35HRC)	Alloy Steel (35-48HRC)	PH, Ferrite, Martensite Steel (< 35HRC)	Hardened Steel (45-55HRC)	Hardened Steel (55-60HRC)	Hardened Steel (> 60HRC)
○	◎		◎	◎	○

◎ Most Suitable ○ Suitable

Recommended Cutting Data ※ P581

SH260-SH4A-H

4 Flutes, Long Shank, Square, 45° Helix Angle

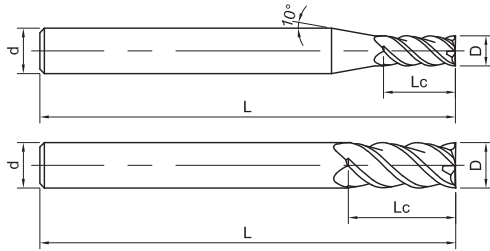

Fig1

Fig2



Please refer to page 167

Ordering Code	D	Lc	L	d	Figure No.	Stock
SH260-SH4A-3-60-H	3	9	60	4	1	○
SH260-SH4A-4-60-H	4	12	60	4	2	●
SH260-SH4A-4-75-H-6	4	12	75	6	1	●
SH260-SH4A-5-60-H	5	15	60	6	1	●
SH260-SH4A-6-75-H	6	18	75	6	2	●
SH260-SH4A-6-100-H	6	18	100	6	2	●
SH260-SH4A-8-75-H	8	24	75	8	2	●
SH260-SH4A-8-100-H	8	24	100	8	2	●
SH260-SH4A-10-100-H	10	30	100	10	2	●
SH260-SH4A-12-100-H	12	36	100	12	2	●
SH260-SH4A-16-150-H	16	48	150	16	2	●
SH260-SH4A-20-150-H	20	60	150	20	2	○

● Stock ○ Available upon Order

D	Tol
D ≤ 6	0 -0.01
6 < D ≤ 12	0 -0.02
D > 12	0 -0.03

Unit (mm)

Workpiece Material					
P			H		
1 2 3 4	5	6	1	2	3 4
Carbon Steel, Alloy Steel (< 35HRC)	Alloy Steel (35-48HRC)	PH, Ferrite, Martensite Steel (< 35HRC)	Hardened Steel (45-55HRC)	Hardened Steel (55-60HRC)	Hardened Steel (> 60HRC)
○	◎		◎	◎	○

◎ Most Suitable ○ Suitable

Recommended Cutting Data ※ P581

SH260-SN4-H

4 Flutes, Long Neck, Square

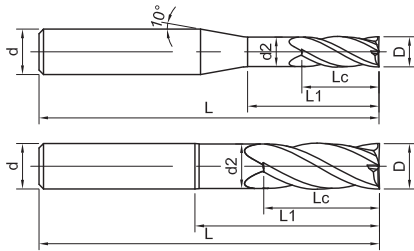

Fig1

Fig2



Please refer to page 167

Ordering Code	D	Lc	d2	L1	L	d	Figure No.	Stock
SH260-SN4-1-3-H	1	2	0.96	3	50	4	1	●
SH260-SN4-1-6-H	1	2	0.96	6	50	4	1	●
SH260-SN4-2-6-H	2	4	1.92	6	50	4	1	●
SH260-SN4-2-6-H-6	2	4	1.92	6	50	6	1	●
SH260-SN4-2-12-H	2	4	1.92	12	50	4	1	●
SH260-SN4-2.5-10-H	2.5	5	2.4	10	60	4	1	●
SH260-SN4-3-9-H	3	6	2.88	9	50	4	1	●
SH260-SN4-3-18-H-6	3	6	2.88	18	60	6	1	●
SH260-SN4-4-12-H	4	8	3.8	12	60	4	2	●
SH260-SN4-4-24-H-6	4	8	3.8	24	60	6	1	●
SH260-SN4-5-15-H	5	10	4.8	15	60	6	1	●
SH260-SN4-6-18-H	6	12	5.8	18	75	6	2	●
SH260-SN4-6-24-H	6	12	5.8	24	75	6	2	●
SH260-SN4-8-24-H	8	16	7.8	24	75	8	2	●
SH260-SN4-8-32-H	8	16	7.8	32	100	8	2	●
SH260-SN4-10-30-H	10	20	9.8	30	100	10	2	●
SH260-SN4-10-40-H	10	20	9.8	40	100	10	2	●
SH260-SN4-12-36-H	12	24	11.8	36	100	12	2	○

● Stock ○ Available upon Order

D	Tol
D ≤ 6	0 -0.01
6 < D ≤ 12	0 -0.02
D > 12	0 -0.03

Unit (mm)

Workpiece Material

P			H		
1 2 3 4	5	6	1	2	3 4
Carbon Steel, Alloy Steel (< 35HRC)	Alloy Steel (35-48HRC)	PH, Ferrite, Martensite Steel (< 35HRC)	Hardened Steel (45-55HRC)	Hardened Steel (55-60HRC)	Hardened Steel (> 60HRC)
○	◎		◎	◎	○

◎ Most Suitable ○ Suitable

Recommended Cutting Data ※ P581

SH260-SL4-H

4 Flutes, Long Flute, Square

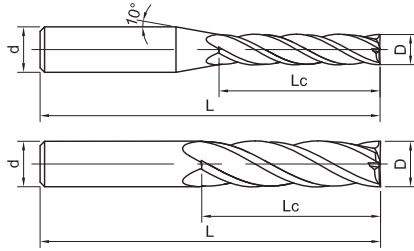

Fig1

Fig2



Please refer to page 167

Ordering Code	D	Lc	L	d	Figure No.	Stock
SH260-SL4-1-5-H	1	5	50	4	1	●
SH260-SL4-2-10-H	2	10	50	4	1	●
SH260-SL4-3-15-H	3	15	50	4	1	●
SH260-SL4-4-16-H	4	16	60	4	2	●
SH260-SL4-4-20-H-6	4	20	60	6	1	●
SH260-SL4-5-20-H	5	20	60	6	1	●
SH260-SL4-6-24-H	6	24	75	6	2	●
SH260-SL4-8-32-H	8	32	75	8	2	●
SH260-SL4-8-35-H	8	35	100	8	2	●
SH260-SL4-10-40-H	10	40	100	10	2	●
SH260-SL4-10-50-H	10	50	120	10	2	●
SH260-SL4-12-50-H	12	50	120	12	2	●
SH260-SL4-16-60-H	16	60	150	16	2	●

● Stock ○ Available upon Order

D	Tol
$D \leq 6$	$\begin{matrix} 0 \\ -0.01 \end{matrix}$
$6 < D \leq 12$	$\begin{matrix} 0 \\ -0.02 \end{matrix}$
$D > 12$	$\begin{matrix} 0 \\ -0.03 \end{matrix}$

Unit (mm)

Workpiece Material

P			H		
1 2 3 4	5	6	1	2	3 4
Carbon Steel, Alloy Steel (< 35HRC)	Alloy Steel (35-48HRC)	PH, Ferrite, Martensite Steel (< 35HRC)	Hardened Steel (45-55HRC)	Hardened Steel (55-60HRC)	Hardened Steel (> 60HRC)
○	◎		◎	◎	○

◎ Most Suitable ○ Suitable

Recommended Cutting Data ※ P581

SH260-SL4A-H

4 Flutes, Long Flute, Square, 45° Helix Angle

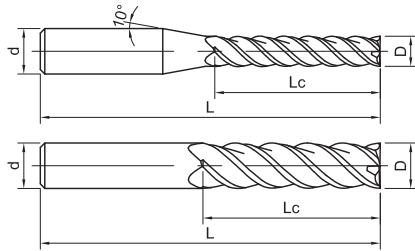

Fig1

Fig2



Please refer to page 167

Ordering Code	D	Lc	L	d	Figure No.	Stock
SH260-SL4A-3-12-H-6	3	12	50	6	1	●
SH260-SL4A-4-16-H	4	16	60	4	2	●
SH260-SL4A-5-20-H	5	20	60	6	1	●
SH260-SL4A-6-24-H	6	24	75	6	2	●
SH260-SL4A-8-36-H	8	36	100	8	2	●
SH260-SL4A-10-45-H	10	45	100	10	2	●
SH260-SL4A-10-50-H	10	50	150	10	2	●
SH260-SL4A-12-50-H	12	50	100	12	2	●
SH260-SL4A-12-60-H	12	60	150	12	2	●
SH260-SL4A-16-65-H	16	65	150	16	2	●
SH260-SL4A-20-75-H	20	75	150	20	2	●

● Stock ○ Available upon Order

D	Tol
D ≤ 6	0 -0.01
6 < D ≤ 12	0 -0.02
D > 12	0 -0.03

Unit (mm)

Workpiece Material					
P			H		
1 2 3 4	5	6	1	2	3 4
Carbon Steel, Alloy Steel (< 35HRC)	Alloy Steel (35-48HRC)	PH, Ferrite, Martensite Steel (< 35HRC)	Hardened Steel (45-55HRC)	Hardened Steel (55-60HRC)	Hardened Steel (> 60HRC)
○	◎		◎	◎	○

◎ Most Suitable ○ Suitable

Recommended Cutting Data ※ P581

SH260-S6-H

6 Flutes, Standard Length, Square

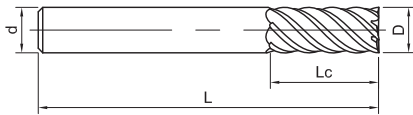

Fig1



Please refer to page 167

Ordering Code	D	Lc	L	d	Figure No.	Stock
SH260-S6-6-15-H	6	15	50	6	1	●
SH260-S6-8-20-H	8	20	60	8	1	●
SH260-S6-10-25-H	10	25	75	10	1	●
SH260-S6-10-30-H	10	30	75	10	1	●
SH260-S6-12-30-H	12	30	75	12	1	●
SH260-S6-16-40-H	16	40	100	16	1	●
SH260-S6-20-45-H	20	45	100	20	1	●

● Stock ○ Available upon Order

D	Tol
D ≤ 6	0 -0.010
D > 6	0 -0.020

Unit (mm)

Workpiece Material					
P			H		
1 2 3 4	5	6	1	2	3 4
Carbon Steel, Alloy Steel (< 35HRC)	Alloy Steel (35-48HRC)	PH, Ferrite, Martensite Steel (< 35HRC)	Hardened Steel (45-55HRC)	Hardened Steel (55-60HRC)	Hardened Steel (> 60HRC)
○	◎		◎	◎	○

◎ Most Suitable ○ Suitable

Recommended Cutting Data ※ P581

SH260-SH6-H

6 Flutes, Long Shank, Square

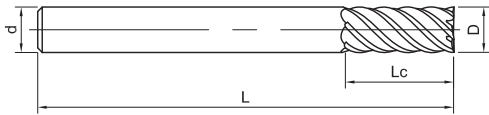

Fig1



Please refer to page 167

Ordering Code	D	Lc	L	d	Figure No.	Stock
SH260-SH6-6-60-H	6	15	60	6	1	●
SH260-SH6-8-75-H	8	20	75	8	1	○
SH260-SH6-10-100-H	10	25	100	10	1	●
SH260-SH6-12-100-H	12	30	100	12	1	●
SH260-SH6-16-150-H	16	45	150	16	1	○
SH260-SH6-20-150-H	20	60	150	20	1	○

● Stock ○ Available upon Order

D	Tol
D ≤ 6	0 -0.010
D > 6	0 -0.020

Unit (mm)

Workpiece Material					
P			H		
1 2 3 4	5	6	1	2	3 4
Carbon Steel, Alloy Steel (< 35HRC)	Alloy Steel (35-48HRC)	PH, Ferrite, Martensite Steel (< 35HRC)	Hardened Steel (45-55HRC)	Hardened Steel (55-60HRC)	Hardened Steel (> 60HRC)
○	◎		◎	◎	○

◎ Most Suitable ○ Suitable

Recommended Cutting Data ※ P581

SH260-SL6-H

6 Flutes, Long Flute, Square

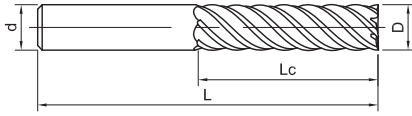

Fig1



Please refer to page 167

Ordering Code	D	Lc	L	d	Figure No.	Stock
SH260-SL6-6-24-H	6	24	75	6	1	○
SH260-SL6-6-30-H	6	30	100	6	1	●
SH260-SL6-8-32-H	8	32	75	8	1	●
SH260-SL6-8-40-H	8	40	100	8	1	●
SH260-SL6-10-40-H	10	40	100	10	1	●
SH260-SL6-10-50-H	10	50	150	10	1	●
SH260-SL6-12-50-H	12	50	100	12	1	●
SH260-SL6-12-60-H	12	60	150	12	1	●
SH260-SL6-16-70-H	16	70	150	16	1	●
SH260-SL6-16-80-H	16	80	150	16	1	●
SH260-SL6-20-80-H	20	80	150	20	1	●

● Stock ○ Available upon Order

D	Tol
D ≤ 6	0 -0.010
D > 6	0 -0.020

Unit (mm)

Workpiece Material

P			H		
1 2 3 4	5	6	1	2	3 4
Carbon Steel, Alloy Steel (< 35HRC)	Alloy Steel (35-48HRC)	PH, Ferrite, Martensite Steel (< 35HRC)	Hardened Steel (45-55HRC)	Hardened Steel (55-60HRC)	Hardened Steel (> 60HRC)
○	◎		◎	◎	○

◎ Most Suitable ○ Suitable

Recommended Cutting Data ※ P581

SH260-R2-H

2 Flutes, Corner Radius

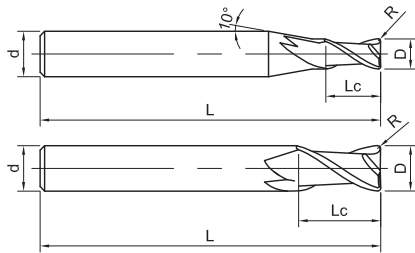

Fig1

Fig2



Please refer to page 167

Ordering Code	D	Lc	R	L	d	Figure No.	Stock
SH260-R2-1-0.1-H	1	2.5	0.1	50	4	1	●
SH260-R2-1-0.2-H	1	2.5	0.2	50	4	1	●
SH260-R2-2-0.2-H	2	5	0.2	50	4	1	●
SH260-R2-2-0.3-H	2	5	0.3	50	4	1	●
SH260-R2-3-0.2-H	3	7.5	0.2	50	4	1	●
SH260-R2-3-0.5-H	3	7.5	0.5	50	4	1	●
SH260-R2-4-0.2-H	4	10	0.2	50	4	2	○
SH260-R2-4-0.5-H	4	10	0.5	50	4	2	●
SH260-R2-6-0.5-H	6	15	0.5	50	6	2	●
SH260-R2-6-1-H	6	15	1	50	6	2	●
SH260-R2-8-0.2-H	8	20	0.2	60	8	2	●

● Stock ○ Available upon Order

D	Tol
D ≤ 6	0 -0.01
D > 6	0 -0.02

Unit (mm)

Workpiece Material					
P			H		
1 2 3 4	5	6	1	2	3 4
Carbon Steel, Alloy Steel (< 35HRC)	Alloy Steel (35-48HRC)	PH, Ferrite, Martensite Steel (< 35HRC)	Hardened Steel (45-55HRC)	Hardened Steel (55-60HRC)	Hardened Steel (> 60HRC)
○	◎		◎	◎	○

◎ Most Suitable ○ Suitable

Recommended Cutting Data ※ P580

SH260-RN2-H

2 Flutes, Corner Radius, Long Neck

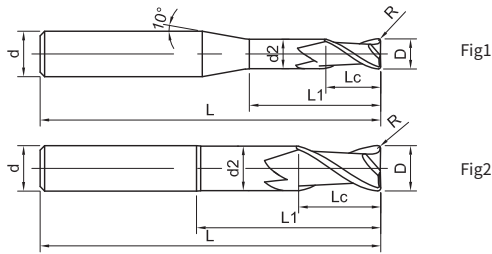

Please refer to page 167

Ordering Code	D	Lc	R	d2	L1	L	d	Figure No.	Stock
SH260-RN2-0.8-2.5-0.1-H	0.8	1.2	0.1	0.76	2.5	50	4	1	●
SH260-RN2-0.8-5-0.1-H	0.8	1.2	0.1	0.76	5	50	4	1	●
SH260-RN2-1-3-0.1-H	1	1.5	0.1	0.96	3	50	4	1	●
SH260-RN2-1-3-0.2-H	1	1.5	0.2	0.96	3	50	4	1	●
SH260-RN2-1-4-0.2-H	1	1.5	0.2	0.96	4	50	4	1	●
SH260-RN2-1-6-0.1-H	1	1.5	0.1	0.96	6	50	4	1	●
SH260-RN2-1-6-0.2-H	1	1.5	0.2	0.96	6	50	4	1	●
SH260-RN2-1-8-0.2-H	1	1.5	0.2	0.96	8	50	4	1	●
SH260-RN2-1-10-0.2-H	1	1.5	0.2	0.96	10	50	4	1	●
SH260-RN2-1.5-6-0.2-H	1.5	2.5	0.2	1.44	6	50	4	1	●
SH260-RN2-1.5-8-0.2-H	1.5	2.5	0.2	1.44	8	50	4	1	●
SH260-RN2-1.5-10-0.2-H	1.5	2.5	0.2	1.44	10	50	4	1	●
SH260-RN2-2-6-0.2-H	2	3	0.2	1.92	6	50	4	1	●
SH260-RN2-2-6-0.5-H	2	3	0.5	1.92	6	50	4	1	●
SH260-RN2-2-8-0.2-H	2	3	0.2	1.92	8	50	4	1	●
SH260-RN2-2-10-0.2-H	2	3	0.2	1.92	10	50	4	1	●

● Stock ○ Available upon Order

D	Tol
D ≤ 6	0 -0.01
D > 6	0 -0.02

Unit (mm)

Workpiece Material					
P			H		
1 2 3 4	5	6	1	2	3 4
Carbon Steel, Alloy Steel (< 35HRC)	Alloy Steel (35-48HRC)	PH, Ferrite, Martensite Steel (< 35HRC)	Hardened Steel (45-55HRC)	Hardened Steel (55-60HRC)	Hardened Steel (> 60HRC)
○	◎		◎	◎	○

◎ Most Suitable ○ Suitable

Recommended Cutting Data ※ P580

SH260-RN2-H

2 Flutes, Corner Radius, Long Neck

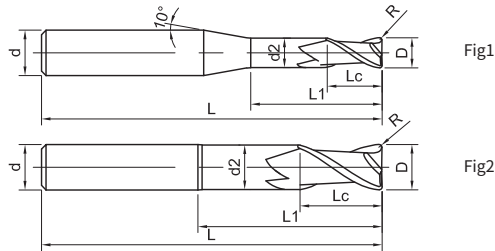

Please refer to page 167

» Continuation

Ordering Code	D	Lc	R	d2	L1	L	d	Figure No.	Stock
SH260-RN2-2-12-0.2-H	2	3	0.2	1.92	12	50	4	1	●
SH260-RN2-2-12-0.5-H	2	3	0.5	1.92	12	50	4	1	●
SH260-RN2-3-9-0.2-H	3	4.5	0.2	2.88	9	50	4	1	●
SH260-RN2-3-9-0.5-H	3	4.5	0.5	2.88	9	50	4	1	○
SH260-RN2-3-18-0.2-H	3	4.5	0.2	2.88	18	50	4	1	●
SH260-RN2-3-18-0.5-H	3	4.5	0.5	2.88	18	50	4	1	●
SH260-RN2-4-12-0.2-H	4	6	0.2	3.8	12	50	4	2	●
SH260-RN2-4-12-0.5-H	4	6	0.5	3.8	12	50	4	2	○
SH260-RN2-4-24-0.2-H	4	6	0.2	3.8	24	60	4	2	○
SH260-RN2-4-24-0.5-H	4	6	0.5	3.8	24	60	4	2	●
SH260-RN2-5-15-0.5-H	5	7.5	0.5	4.8	15	50	6	1	○
SH260-RN2-5-30-0.5-H	5	7.5	0.5	4.8	30	60	6	1	○
SH260-RN2-6-18-0.5-H	6	9	0.5	5.8	18	60	6	2	○
SH260-RN2-6-36-0.5-H	6	9	0.5	5.8	36	60	6	2	●

● Stock ○ Available upon Order

D	Tol
D ≤ 6	0 -0.01
D > 6	0 -0.02

Unit (mm)

Workpiece Material

P			H		
1 2 3 4	5	6	1	2	3 4
Carbon Steel, Alloy Steel (< 35HRC)	Alloy Steel (35-48HRC)	PH, Ferrite, Martensite Steel (< 35HRC)	Hardened Steel (45-55HRC)	Hardened Steel (55-60HRC)	Hardened Steel (> 60HRC)
○	◎		◎	◎	○

◎ Most Suitable ○ Suitable

Recommended Cutting Data ※ P580

SH260-R4-H

4 Flutes, Corner Radius

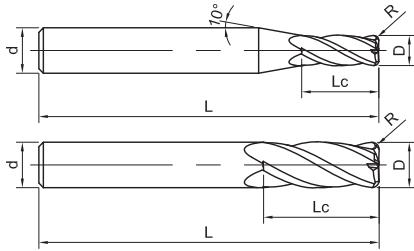

Fig1

Fig2



Please refer to page 167

Ordering Code	D	Lc	R	L	d	Figure No.	Stock
SH260-R4-1-0.1-H	1	2.5	0.1	50	4	1	●
SH260-R4-1-0.2-H	1	2.5	0.2	50	4	1	●
SH260-R4-1.5-0.1-H	1.5	4	0.1	50	4	1	●
SH260-R4-1.5-0.2-H	1.5	4	0.2	50	4	1	●
SH260-R4-1.5-0.3-H	1.5	4	0.3	50	4	1	●
SH260-R4-2-0.1-H	2	5	0.1	50	4	1	●
SH260-R4-2-0.2-H	2	5	0.2	50	4	1	●
SH260-R4-2-0.3-H	2	5	0.3	50	4	1	●
SH260-R4-2-0.5-H	2	5	0.5	50	4	1	●
SH260-R4-3-0.2-H	3	8	0.2	50	4	1	●
SH260-R4-3-0.3-H	3	8	0.3	50	4	1	●
SH260-R4-3-0.5-H	3	8	0.5	50	4	1	●
SH260-R4-3-0.2-H-3	3	8	0.2	50	3	2	●
SH260-R4-3-0.3-H-3	3	8	0.3	50	3	2	●
SH260-R4-3-0.5-H-3	3	8	0.5	50	3	2	●
SH260-R4-3-0.2-H-6	3	8	0.2	50	6	1	○
SH260-R4-4-0.2-H	4	10	0.2	50	4	2	●

● Stock ○ Available upon Order

D	Tol
D ≤ 6	0 -0.01
6 < D ≤ 12	0 -0.02
D > 12	0 -0.03

Unit (mm)

Workpiece Material					
P			H		
1	2	3	4	5	6
Carbon Steel, Alloy Steel (< 35HRC)	Alloy Steel (35-48HRC)	PH, Ferrite, Martensite Steel (< 35HRC)	Hardened Steel (45-55HRC)	Hardened Steel (55-60HRC)	Hardened Steel (> 60HRC)
○	○	○	○	○	○

○ Most Suitable ○ Suitable

Recommended Cutting Data ※ P581

SH260-R4-H

4 Flutes, Corner Radius

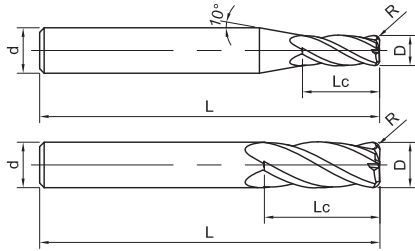

Fig1

Fig2



Please refer to page 167

» Continuation

Ordering Code	D	Lc	R	L	d	Figure No.	Stock
SH260-R4-4-0.3-H	4	10	0.3	50	4	2	●
SH260-R4-4-0.5-H	4	10	0.5	50	4	2	●
SH260-R4-4-1-H	4	10	1	50	4	2	●
SH260-R4-4-0.5-H-6	4	10	0.5	50	6	1	●
SH260-R4-5-0.2-H	5	13	0.2	50	6	1	●
SH260-R4-5-0.5-H	5	13	0.5	50	6	1	●
SH260-R4-6-0.2-H	6	15	0.2	50	6	2	●
SH260-R4-6-0.3-H	6	15	0.3	50	6	2	●
SH260-R4-6-0.5-H	6	15	0.5	50	6	2	●
SH260-R4-6-1-H	6	15	1	50	6	2	●
SH260-R4-8-0.2-H	8	20	0.2	60	8	2	●
SH260-R4-8-0.3-H	8	20	0.3	60	8	2	●
SH260-R4-8-0.4-H	8	20	0.4	60	8	2	●
SH260-R4-8-0.5-H	8	20	0.5	60	8	2	●
SH260-R4-8-1-H	8	20	1	60	8	2	●
SH260-R4-8-2-H	8	20	2	60	8	2	○
SH260-R4-10-0.2-H	10	25	0.2	75	10	2	●

● Stock ○ Available upon Order

D	Tol
D ≤ 6	0 -0.01
6 < D ≤ 12	0 -0.02
D > 12	0 -0.03

Unit (mm)

Workpiece Material					
P			H		
1 2 3 4	5	6	1	2	3 4
Carbon Steel, Alloy Steel (< 35HRC)	Alloy Steel (35-48HRC)	PH, Ferrite, Martensite Steel (< 35HRC)	Hardened Steel (45-55HRC)	Hardened Steel (55-60HRC)	Hardened Steel (> 60HRC)
○	◎		◎	◎	○

◎ Most Suitable ○ Suitable

Recommended Cutting Data ※ P581

SH260-R4-H

4 Flutes, Corner Radius

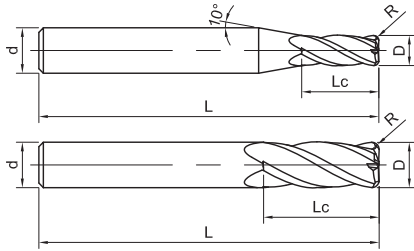

Fig1

Fig2



Please refer to page 167

» Continuation

Ordering Code	D	Lc	R	L	d	Figure No.	Stock
SH260-R4-10-0.5-H	10	25	0.5	75	10	2	●
SH260-R4-10-1-H	10	25	1	75	10	2	●
SH260-R4-10-2-H	10	25	2	75	10	2	●
SH260-R4-12-0.2-H	12	30	0.2	75	12	2	●
SH260-R4-12-0.5-H	12	30	0.5	75	12	2	●
SH260-R4-12-1-H	12	30	1	75	12	2	●
SH260-R4-12-2-H	12	30	2	75	12	2	●

● Stock ○ Available upon Order

D	Tol
D ≤ 6	0 -0.01
6 < D ≤ 12	0 -0.02
D > 12	0 -0.03

Unit (mm)

Workpiece Material					
P			H		
1	2	3	4	5	6
Carbon Steel, Alloy Steel (< 35HRC)	Alloy Steel (35-48HRC)	PH, Ferrite, Martensite Steel (< 35HRC)	Hardened Steel (45-55HRC)	Hardened Steel (55-60HRC)	Hardened Steel (> 60HRC)
○	○	○	○	○	○

○ Most Suitable ○ Suitable

Recommended Cutting Data ※ P581

SH260-R4A-H

4 Flutes, Corner Radius, 45° Helix Angle

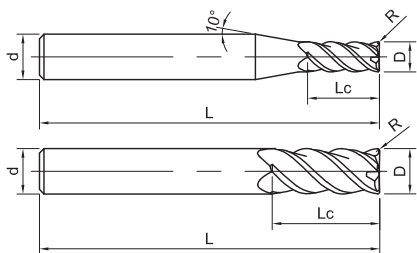

Fig1

Fig2



Please refer to page 167

Ordering Code	D	Lc	R	L	d	Figure No.	Stock
SH260-R4A-1-0.1-H	1	2.5	0.1	50	4	1	●
SH260-R4A-1-0.2-H	1	2.5	0.2	50	4	1	●
SH260-R4A-2-0.1-H	2	5	0.1	50	4	1	●
SH260-R4A-2-0.2-H	2	5	0.2	50	4	1	●
SH260-R4A-2-0.3-H	2	5	0.3	50	4	1	●
SH260-R4A-2-0.5-H	2	5	0.5	50	4	1	●
SH260-R4A-3-0.2-H-3	3	7.5	0.2	50	3	2	●
SH260-R4A-3-0.2-H	3	7.5	0.2	50	4	1	●
SH260-R4A-3-0.3-H	3	7.5	0.3	50	4	1	●
SH260-R4A-3-0.5-H	3	7.5	0.5	50	4	1	●
SH260-R4A-4-0.2-H	4	10	0.2	50	4	2	●
SH260-R4A-4-0.5-H	4	10	0.5	50	4	2	●
SH260-R4A-4-0.5-H-6	4	10	0.5	50	6	1	●
SH260-R4A-5-0.2-H	5	13	0.2	50	6	1	●
SH260-R4A-5-0.5-H	5	13	0.5	50	6	1	●
SH260-R4A-6-0.2-H	6	15	0.2	50	6	2	●

● Stock ○ Available upon Order

D	Tol
D ≤ 6	0 -0.01
6 < D ≤ 12	0 -0.02
D > 12	0 -0.03

Unit (mm)

Workpiece Material					
P			H		
1 2 3 4	5	6	1	2	3 4
Carbon Steel, Alloy Steel (< 35HRC)	Alloy Steel (35-48HRC)	PH, Ferrite, Martensite Steel (< 35HRC)	Hardened Steel (45-55HRC)	Hardened Steel (55-60HRC)	Hardened Steel (> 60HRC)
○	◎		◎	◎	○

◎ Most Suitable ○ Suitable

Recommended Cutting Data ※ P581

SH260-R4A-H

4 Flutes, Corner Radius, 45° Helix Angle

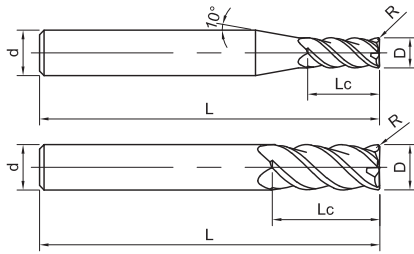

Fig1

Fig2



Please refer to page 167

» Continuation

Ordering Code	D	Lc	R	L	d	Figure No.	Stock
SH260-R4A-6-0.5-H	6	15	0.5	50	6	2	●
SH260-R4A-6-1-H	6	15	1	50	6	2	●
SH260-R4A-8-0.2-H	8	20	0.2	60	8	2	●
SH260-R4A-8-0.5-H	8	20	0.5	60	8	2	●
SH260-R4A-8-1-H	8	20	1	60	8	2	○
SH260-R4A-10-0.2-H	10	25	0.2	75	10	2	●
SH260-R4A-10-0.5-H	10	25	0.5	75	10	2	●
SH260-R4A-10-1-H	10	25	1	75	10	2	●
SH260-R4A-10-2-H	10	25	2	75	10	2	●
SH260-R4A-12-0.5-H	12	30	0.5	75	12	2	○
SH260-R4A-12-1-H	12	30	1	75	12	2	●
SH260-R4A-12-2-H	12	30	2	75	12	2	●

● Stock ○ Available upon Order

D	Tol
D ≤ 6	0 -0.01
6 < D ≤ 12	0 -0.02
D > 12	0 -0.03

Unit (mm)

Workpiece Material					
P			H		
1 2 3 4	5	6	1	2	3 4
Carbon Steel, Alloy Steel (< 35HRC)	Alloy Steel (35-48HRC)	PH, Ferrite, Martensite Steel (< 35HRC)	Hardened Steel (45-55HRC)	Hardened Steel (55-60HRC)	Hardened Steel (> 60HRC)
○	◎		◎	◎	○

◎ Most Suitable ○ Suitable

Recommended Cutting Data ※ P581

SH260-RH4-H

4 Flutes, Corner Radius, Long Shank

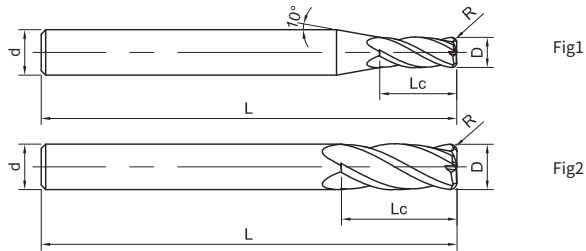

Fig1

Fig2



Please refer to page 167

Ordering Code	D	Lc	R	L	d	Figure No.	Stock
SH260-RH4-2-60-0.5-H-6	2	5	0.5	60	6	1	○
SH260-RH4-2.5-60-0.5-H-6	2.5	6	0.5	60	6	1	●
SH260-RH4-3-60-0.5-H-6	3	8	0.5	60	6	1	●
SH260-RH4-3-75-0.5-H-6	3	8	0.5	75	6	1	●
SH260-RH4-4-60-0.2-H	4	10	0.2	60	4	2	●
SH260-RH4-4-60-0.3-H	4	10	0.3	60	4	2	●
SH260-RH4-4-60-0.5-H	4	10	0.5	60	4	2	●
SH260-RH4-4-75-0.5-H	4	10	0.5	75	4	2	●
SH260-RH4-4-60-1-H	4	10	1	60	4	2	●
SH260-RH4-4-75-0.5-H-6	4	10	0.5	75	6	1	●
SH260-RH4-4-60-1-H-6	4	10	1	60	6	1	●
SH260-RH4-5-60-0.5-H	5	13	0.5	60	6	1	●
SH260-RH4-6-60-0.2-H	6	15	0.2	60	6	2	●
SH260-RH4-6-75-0.2-H	6	15	0.2	75	6	2	●
SH260-RH4-6-60-0.3-H	6	15	0.3	60	6	2	●
SH260-RH4-6-75-0.3-H	6	15	0.3	75	6	2	●
SH260-RH4-6-60-0.5-H	6	15	0.5	60	6	2	●
SH260-RH4-6-75-0.5-H	6	15	0.5	75	6	2	●
SH260-RH4-6-100-0.5-H	6	15	0.5	100	6	2	●

● Stock ○ Available upon Order

D	Tol
D ≤ 6	0 -0.01
6 < D ≤ 12	0 -0.02
D > 12	0 -0.03

Unit (mm)

Workpiece Material					
P			H		
1	2	3	4	5	6
Carbon Steel, Alloy Steel (< 35HRC)	Alloy Steel (35-48HRC)	PH, Ferrite, Martensite Steel (< 35HRC)	Hardened Steel (45-55HRC)	Hardened Steel (55-60HRC)	Hardened Steel (> 60HRC)
○	○	○	○	○	○

○ Most Suitable ○ Suitable

Recommended Cutting Data ※ P581

SH260-RH4-H

4 Flutes, Corner Radius, Long Shank

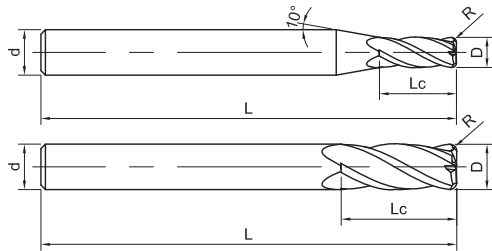

Fig1

Fig2



Please refer to page 167

» Continuation

Ordering Code	D	Lc	R	L	d	Figure No.	Stock
SH260-RH4-6-60-1-H	6	15	1	60	6	2	●
SH260-RH4-6-75-1-H	6	15	1	75	6	2	●
SH260-RH4-8-75-0.1-H	8	20	0.1	75	8	2	●
SH260-RH4-8-75-0.2-H	8	20	0.2	75	8	2	●
SH260-RH4-8-75-0.3-H	8	20	0.3	75	8	2	●
SH260-RH4-8-75-0.5-H	8	20	0.5	75	8	2	●
SH260-RH4-8-100-0.5-H	8	20	0.5	100	8	2	●
SH260-RH4-8-75-1-H	8	20	1	75	8	2	●
SH260-RH4-8-100-1-H	8	20	1	100	8	2	●
SH260-RH4-8-100-2-H	8	20	2	100	8	2	●
SH260-RH4-10-100-0.2-H	10	25	0.2	100	10	2	●
SH260-RH4-10-100-0.5-H	10	25	0.5	100	10	2	●
SH260-RH4-10-120-0.5-H	10	25	0.5	120	10	2	●
SH260-RH4-10-100-1-H	10	25	1	100	10	2	●
SH260-RH4-10-120-1-H	10	25	1	120	10	2	●
SH260-RH4-10-100-2-H	10	25	2	100	10	2	●
SH260-RH4-12-100-0.5-H	12	30	0.5	100	12	2	●
SH260-RH4-12-120-0.5-H	12	30	0.5	120	12	2	●
SH260-RH4-12-100-1-H	12	30	1	100	12	2	●
SH260-RH4-12-120-1-H	12	30	1	120	12	2	●
SH260-RH4-12-120-2-H	12	30	2	120	12	2	●

● Stock ○ Available upon Order

D	Tol
D ≤ 6	0 -0.01
6 < D ≤ 12	0 -0.02
D > 12	0 -0.03

Unit (mm)

Workpiece Material

P			H		
1	2	3	4	5	6
Carbon Steel, Alloy Steel (< 35HRC)	Alloy Steel (35-48HRC)	PH, Ferrite, Martensite Steel (< 35HRC)	Hardened Steel (45-55HRC)	Hardened Steel (55-60HRC)	Hardened Steel (> 60HRC)
○	◎		◎	◎	○

◎ Most Suitable ○ Suitable

Recommended Cutting Data ※ P581

SH260-RH4A-H

4 Flutes, Corner Radius, Long Shank, 45° Helix Angle

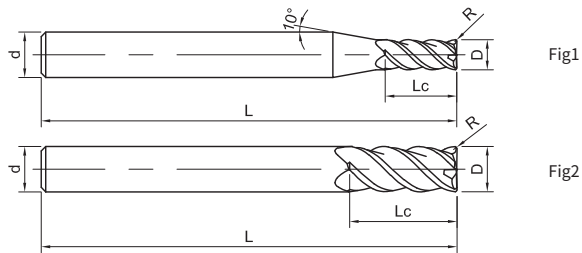

Please refer to page 167

Ordering Code	D	Lc	R	L	d	Figure No.	Stock
SH260-RH4A-2-60-0.5-H-6	2	6	0.5	60	6	1	○
SH260-RH4A-3-60-0.5-H-6	3	9	0.5	60	6	1	●
SH260-RH4A-4-60-0.2-H	4	12	0.2	60	4	2	●
SH260-RH4A-4-60-0.5-H	4	12	0.5	60	4	2	●
SH260-RH4A-4-75-0.5-H	4	12	0.5	75	4	2	●
SH260-RH4A-4-75-0.5-H-6	4	12	0.5	75	6	1	●
SH260-RH4A-6-60-0.2-H	6	18	0.2	60	6	2	●
SH260-RH4A-6-75-0.2-H	6	18	0.2	75	6	2	●
SH260-RH4A-6-100-0.5-H	6	18	0.5	100	6	2	○
SH260-RH4A-6-60-0.5-H	6	18	0.5	60	6	2	●
SH260-RH4A-6-75-0.5-H	6	18	0.5	75	6	2	●
SH260-RH4A-6-60-1-H	6	18	1	60	6	2	●

● Stock ○ Available upon Order

D	Tol
D ≤ 6	0 -0.01
6 < D ≤ 12	0 -0.02
D > 12	0 -0.03

Unit (mm)

Workpiece Material					
P			H		
1	2	3	4	5	6
Carbon Steel, Alloy Steel (< 35HRC)	Alloy Steel (35-48HRC)	PH, Ferrite, Martensite Steel (< 35HRC)	Hardened Steel (45-55HRC)	Hardened Steel (55-60HRC)	Hardened Steel (> 60HRC)
○	○	○	○	○	○

○ Most Suitable ○ Suitable

Recommended Cutting Data ※ P581

SH260-RH4A-H

4 Flutes, Corner Radius, Long Shank, 45° Helix Angle

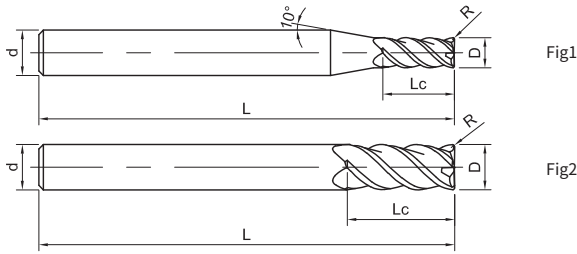

Please refer to page 167

» Continuation

Ordering Code	D	Lc	R	L	d	Figure No.	Stock
SH260-RH4A-6-75-1-H	6	18	1	75	6	2	●
SH260-RH4A-8-75-0.5-H	8	24	0.5	75	8	2	●
SH260-RH4A-8-100-0.5-H	8	24	0.5	100	8	2	●
SH260-RH4A-8-75-1-H	8	24	1	75	8	2	●
SH260-RH4A-8-100-1-H	8	24	1	100	8	2	●
SH260-RH4A-10-100-0.5-H	10	30	0.5	100	10	2	●
SH260-RH4A-10-120-0.5-H	10	30	0.5	120	10	2	●
SH260-RH4A-10-100-1-H	10	30	1	100	10	2	●
SH260-RH4A-10-120-1-H	10	30	1	120	10	2	●
SH260-RH4A-12-100-0.5-H	12	36	0.5	100	12	2	●
SH260-RH4A-12-120-0.5-H	12	36	0.5	120	12	2	●
SH260-RH4A-12-100-1-H	12	36	1	100	12	2	●

● Stock ○ Available upon Order

D	Tol
D ≤ 6	0 -0.01
6 < D ≤ 12	0 -0.02
D > 12	0 -0.03

Unit (mm)

Workpiece Material					
P			H		
1	2	3	4	5	6
Carbon Steel, Alloy Steel (< 35HRC)	Alloy Steel (35-48HRC)	PH, Ferrite, Martensite Steel (< 35HRC)	Hardened Steel (45-55HRC)	Hardened Steel (55-60HRC)	Hardened Steel (> 60HRC)
○	○	○	○	○	○

○ Most Suitable ○ Suitable

Recommended Cutting Data ※ P581

SH260-RL4A-H

4 Flutes, Corner Radius, Long Flute, 45° Helix Angle

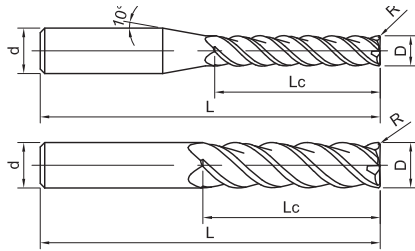

Fig1

Fig2



Please refer to page 167

Ordering Code	D	Lc	R	L	d	Figure No.	Stock
SH260-RL4A-6-20-0.5-H	6	20	0.5	75	6	2	●
SH260-RL4A-8-25-0.5-H	8	25	0.5	100	8	2	●
SH260-RL4A-10-50-0.5-H	10	50	0.5	150	10	2	●
SH260-RL4A-12-50-0.5-H	12	50	0.5	100	12	2	●
SH260-RL4A-12-60-0.5-H	12	60	0.5	150	12	2	●

● Stock ○ Available upon Order

D	Tol
D ≤ 6	0 -0.01
6 < D ≤ 12	0 -0.02
D > 12	0 -0.03

Unit (mm)

Workpiece Material					
P			H		
1	2	3	4	5	6
Carbon Steel, Alloy Steel (< 35HRC)	Alloy Steel (35-48HRC)	PH, Ferrite, Martensite Steel (< 35HRC)	Hardened Steel (45-55HRC)	Hardened Steel (55-60HRC)	Hardened Steel (> 60HRC)
○	○	○	○	○	○

○ Most Suitable ○ Suitable

Recommended Cutting Data ※ P581

SH260-RN4-H

4 Flutes, Corner Radius, Long Neck

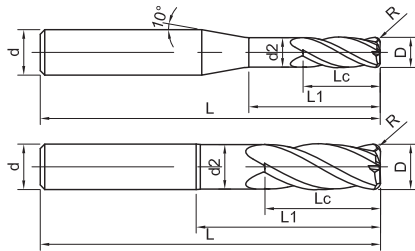

Fig1

Fig2



Please refer to page 167

Ordering Code	D	Lc	R	d2	L1	L	d	Figure No.	Stock
SH260-RN4-1-3-0.1-H	1	2	0.1	0.96	3	50	4	1	●
SH260-RN4-1-6-0.1-H	1	2	0.1	0.96	6	50	4	1	●
SH260-RN4-1.5-4.5-0.1-H	1.5	3	0.1	1.45	4.5	50	4	1	●
SH260-RN4-1.5-6-0.2-H	1.5	3	0.2	1.45	6	50	4	1	●
SH260-RN4-1.5-9-0.1-H	1.5	3	0.1	1.45	9	50	4	1	●
SH260-RN4-2-6-0.2-H	2	4	0.2	1.92	6	50	4	1	●
SH260-RN4-2-6-0.3-H	2	4	0.3	1.92	6	50	4	1	●
SH260-RN4-2-8-0.2-H	2	4	0.2	1.92	8	50	4	1	●
SH260-RN4-2-12-0.2-H	2	4	0.2	1.92	12	50	4	1	●
SH260-RN4-2-12-0.3-H	2	4	0.3	1.92	12	50	4	1	●
SH260-RN4-3-9-0.2-H-6	3	6	0.2	2.88	9	60	6	1	●
SH260-RN4-3-9-0.3-H-6	3	6	0.3	2.88	9	60	6	1	●
SH260-RN4-3-16-0.3-H-6	3	4.5	0.3	2.88	16	75	6	1	●
SH260-RN4-3-18-0.2-H-6	3	6	0.2	2.88	18	60	6	1	●
SH260-RN4-3-18-0.3-H-6	3	6	0.3	2.88	18	60	6	1	●
SH260-RN4-3-18-0.5-H-6	3	6	0.5	2.88	18	60	6	1	●
SH260-RN4-3-20-0.3-H-6	3	6	0.3	2.88	20	75	6	1	●
SH260-RN4-4-12-0.2-H-6	4	8	0.2	3.8	12	60	6	1	●
SH260-RN4-4-12-0.3-H-6	4	8	0.3	3.8	12	60	6	1	●

● Stock ○ Available upon Order

D	Tol
D ≤ 6	0 -0.01
6 < D ≤ 12	0 -0.02
D > 12	0 -0.03

Unit (mm)

Workpiece Material					
P			H		
1	2	3	4	5	6
Carbon Steel, Alloy Steel (< 35HRC)	Alloy Steel (35-48HRC)	PH, Ferrite, Martensite Steel (< 35HRC)	Hardened Steel (45-55HRC)	Hardened Steel (55-60HRC)	Hardened Steel (> 60HRC)
○	◎		◎	◎	○

◎ Most Suitable ○ Suitable

Recommended Cutting Data ※ P581

SH260-RN4-H

4 Flutes, Corner Radius, Long Neck

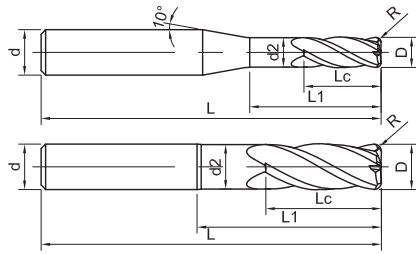

Fig1

Fig2



Please refer to page 167

» Continuation

Ordering Code	D	Lc	R	d2	L1	L	d	Figure No.	Stock
SH260-RN4-4-12-0.5-H-6	4	8	0.5	3.8	12	60	6	1	●
SH260-RN4-4-24-0.5-H-6	4	8	0.5	3.8	24	75	6	1	●
SH260-RN4-6-18-0.2-H	6	12	0.2	5.8	18	75	6	2	●
SH260-RN4-6-18-0.5-H	6	12	0.5	5.8	18	75	6	2	●
SH260-RN4-6-24-0.2-H	6	12	0.2	5.8	24	75	6	2	●
SH260-RN4-6-24-0.5-H	6	12	0.5	5.8	24	75	6	2	●
SH260-RN4-6-24-1-H	6	12	1	5.8	24	75	6	2	●
SH260-RN4-8-24-0.2-H	8	16	0.2	7.8	24	75	8	2	●
SH260-RN4-8-24-0.5-H	8	16	0.5	7.8	24	75	8	2	●
SH260-RN4-8-32-0.2-H	8	16	0.2	7.8	32	75	8	2	●
SH260-RN4-8-32-0.5-H	8	16	0.5	7.8	32	75	8	2	●
SH260-RN4-10-30-0.5-H	10	20	0.5	9.8	30	100	10	2	●
SH260-RN4-10-30-1-H	10	20	1	9.8	30	100	10	2	●
SH260-RN4-10-40-0.5-H	10	20	0.5	9.8	40	100	10	2	●
SH260-RN4-10-40-1-H	10	20	1	9.8	40	100	10	2	●
SH260-RN4-12-36-0.5-H	12	24	0.5	11.8	36	100	12	2	●
SH260-RN4-12-48-0.5-H	12	24	0.5	11.8	48	100	12	2	●
SH260-RN4-12-36-1-H	12	24	1	11.8	36	100	12	2	●
SH260-RN4-12-48-1-H	12	24	1	11.8	48	100	12	2	●

● Stock ○ Available upon Order

D	Tol
D ≤ 6	0 -0.01
6 < D ≤ 12	0 -0.02
D > 12	0 -0.03

Unit (mm)

Workpiece Material

P			H		
1 2 3 4	5	6	1	2	3 4
Carbon Steel, Alloy Steel (< 35HRC)	Alloy Steel (35-48HRC)	PH, Ferrite, Martensite Steel (< 35HRC)	Hardened Steel (45-55HRC)	Hardened Steel (55-60HRC)	Hardened Steel (> 60HRC)
○	◎		◎	◎	○

◎ Most Suitable ○ Suitable

Recommended Cutting Data ※ P581

SH260-B2-H

2 Flutes, Ballnose

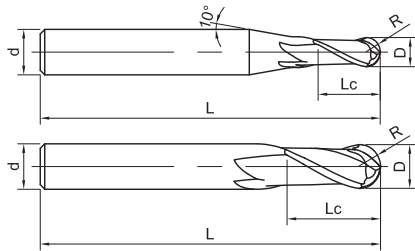

Fig1

Fig2



Please refer to page 167

Ordering Code	D	R	Lc	L	d	Figure No.	Stock
SH260-B2-0.6-0.9-H	0.6	0.3	0.9	50	4	1	●
SH260-B2-1-1.5-H	1	0.5	1.5	50	4	1	●
SH260-B2-1.5-2.5-H	1.5	0.75	2.5	50	4	1	●
SH260-B2-1.5-2.5-H-6	1.5	0.75	2.5	50	6	1	●
SH260-B2-2-3-H	2	1	3	50	4	1	●
SH260-B2-2-3-H-6	2	1	3	50	6	1	●
SH260-B2-3-4.5-H	3	1.5	4.5	50	4	1	●
SH260-B2-3-4.5-H-3	3	1.5	4.5	50	3	2	●
SH260-B2-3-4.5-H-6	3	1.5	4.5	50	6	1	●
SH260-B2-4-6-H	4	2	6	50	4	2	●
SH260-B2-4-6-H-6	4	2	6	50	6	1	●
SH260-B2-5-7.5-H	5	2.5	7.5	50	6	1	●
SH260-B2-6-9-H	6	3	9	50	6	2	●
SH260-B2-7-10.5-H	7	3.5	10.5	60	8	1	●
SH260-B2-8-12-H	8	4	12	60	8	2	●
SH260-B2-10-15-H	10	5	15	75	10	2	●
SH260-B2-12-18-H	12	6	18	75	12	2	●
SH260-B2-16-24-H	16	8	24	100	16	2	●

● Stock ○ Available upon Order

R	Tol
R ≤ 3	±0.005
R > 3	±0.008

Unit (mm)

Workpiece Material					
P			H		
1	2	3	4	5	6
Carbon Steel, Alloy Steel (< 35HRC)	Alloy Steel (35-48HRC)	PH, Ferrite, Martensite Steel (< 35HRC)	Hardened Steel (45-55HRC)	Hardened Steel (55-60HRC)	Hardened Steel (> 60HRC)
○	◎		◎	◎	○

◎ Most Suitable ○ Suitable

Recommended Cutting Data ※ P582

SH260-BH2-H

2 Flutes, Ballnose, with Long Shank Length

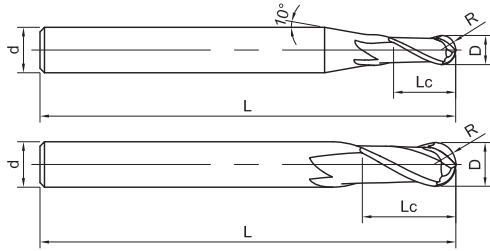

Fig1

Fig2



Please refer to page 167

Ordering Code	D	R	Lc	L	d	Figure No.	Stock
SH260-BH2-2-60-H	2	1	3	60	4	1	●
SH260-BH2-2-60-H-6	2	1	3	60	6	1	●
SH260-BH2-2-75-H	2	1	3	75	4	1	●
SH260-BH2-3-60-H	3	1.5	4.5	60	4	1	●
SH260-BH2-3-60-H-6	3	1.5	4.5	60	6	1	●
SH260-BH2-3-75-H	3	1.5	4.5	75	4	1	●
SH260-BH2-3-75-H-6	3	1.5	4.5	75	6	1	●
SH260-BH2-4-60-H	4	2	6	60	4	2	●
SH260-BH2-4-75-H	4	2	6	75	4	2	●
SH260-BH2-4-60-H-6	4	2	6	60	6	1	●
SH260-BH2-4-75-H-6	4	2	6	75	6	1	●
SH260-BH2-5-60-H	5	2.5	7.5	60	6	1	●

● Stock ○ Available upon Order

R	Tol
R ≤ 3	±0.005
R > 3	±0.008

Unit (mm)

Workpiece Material

P			H		
1 2 3 4	5	6	1	2	3 4
Carbon Steel, Alloy Steel (< 35HRC)	Alloy Steel (35-48HRC)	PH, Ferrite, Martensite Steel (< 35HRC)	Hardened Steel (45-55HRC)	Hardened Steel (55-60HRC)	Hardened Steel (> 60HRC)
○	◎		◎	◎	○

◎ Most Suitable ○ Suitable

Recommended Cutting Data ※ P582

SH260-BH2-H

2 Flutes, Ballnose, with Long Shank Length

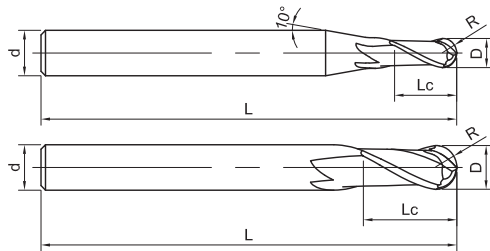

Fig1

Fig2



Please refer to page 167

» Continuation

Ordering Code	D	R	Lc	L	d	Figure No.	Stock
SH260-BH2-6-60-H	6	3	9	60	6	2	●
SH260-BH2-6-75-H	6	3	9	75	6	2	●
SH260-BH2-6-100-H	6	3	9	100	6	2	●
SH260-BH2-8-75-H	8	4	12	75	8	2	●
SH260-BH2-8-100-H	8	4	12	100	8	2	●
SH260-BH2-10-100-H	10	5	15	100	10	2	●
SH260-BH2-10-120-H	10	5	15	120	10	2	●
SH260-BH2-12-100-H	12	6	18	100	12	2	●
SH260-BH2-12-120-H	12	6	18	120	12	2	●
SH260-BH2-16-150-H	16	8	24	150	16	2	○

● Stock ○ Available upon Order

R	Tol
R ≤ 3	±0.005
R > 3	±0.008

Unit (mm)

Workpiece Material					
P			H		
1 2 3 4	5	6	1	2	3 4
Carbon Steel, Alloy Steel (< 35HRC)	Alloy Steel (35-48HRC)	PH, Ferrite, Martensite Steel (< 35HRC)	Hardened Steel (45-55HRC)	Hardened Steel (55-60HRC)	Hardened Steel (> 60HRC)
○	◎		◎	◎	○

◎ Most Suitable ○ Suitable

Recommended Cutting Data ※ P582

SH260-BN2-H

2 Flutes, Ballnose, with Long Neck

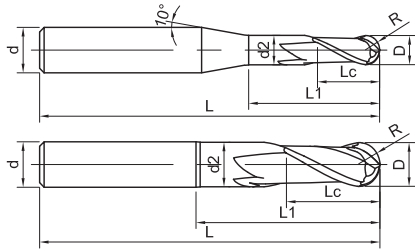

Fig1

Fig2



Please refer to page 167

Ordering Code	D	R	Lc	d2	L1	L	d.	Figure No.	Stock
SH260-BN2-0.4-1.2-H	0.4	0.2	0.4	0.38	1.2	50	4	1	●
SH260-BN2-0.4-2.5-H	0.4	0.2	0.4	0.38	2.5	50	4	1	●
SH260-BN2-0.5-1.5-H	0.5	0.25	0.5	0.48	1.5	50	4	1	●
SH260-BN2-0.5-3-H	0.5	0.25	0.5	0.48	3	50	4	1	●
SH260-BN2-0.6-2-H	0.6	0.3	0.6	0.57	2	50	4	1	●
SH260-BN2-0.6-4-H	0.6	0.3	0.6	0.57	4	50	4	1	●
SH260-BN2-0.8-2.5-H	0.8	0.4	0.8	0.77	2.5	50	4	1	●
SH260-BN2-0.8-4-H	0.8	0.4	0.8	0.77	4	50	4	1	●
SH260-BN2-1-3-H	1	0.5	1	0.96	3	50	4	1	●
SH260-BN2-1-4-H	1	0.5	1	0.96	4	50	4	1	●
SH260-BN2-1-6-H	1	0.5	1	0.96	6	50	4	1	●
SH260-BN2-1-8-H	1	0.5	1	0.96	8	50	4	1	●
SH260-BN2-1-10-H	1	0.5	1	0.96	10	50	4	1	●
SH260-BN2-1.5-5-H	1.5	0.75	1.5	1.45	5	50	4	1	●
SH260-BN2-1.5-5-H-6	1.5	0.75	1.5	1.45	5	50	6	1	●
SH260-BN2-1.5-6-H	1.5	0.75	1.5	1.45	6	50	4	1	●
SH260-BN2-1.5-8-H	1.5	0.75	1.5	1.45	8	50	4	1	●
SH260-BN2-1.5-9-H	1.5	0.75	1.5	1.45	9	50	4	1	●
SH260-BN2-1.5-10-H	1.5	0.75	1.5	1.45	10	50	4	1	●
SH260-BN2-1.5-12-H	1.5	0.75	1.5	1.45	12	50	4	1	●

● Stock ○ Available upon Order

R	Tol
R ≤ 3	±0.005
R > 3	±0.008

Unit (mm)

Workpiece Material					
P			H		
1	2	3	4	5	6
Carbon Steel, Alloy Steel (< 35HRC)	Alloy Steel (35-48HRC)	PH, Ferrite, Martensite Steel (< 35HRC)	Hardened Steel (45-55HRC)	Hardened Steel (55-60HRC)	Hardened Steel (> 60HRC)
○	◎		◎	◎	○

◎ Most Suitable ○ Suitable

Recommended Cutting Data ※ P582

SH260-BN2-H

2 Flutes, Ballnose, with Long Neck

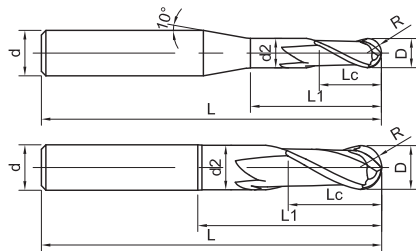

Fig1

Fig2



Please refer to page 167

» Continuation

Ordering Code	D	R	Lc	d2	L1	L	d.	Figure No.	Stock
SH260-BN2-2-6-H	2	1	2	1.95	6	50	4	1	●
SH260-BN2-2-6-H-6	2	1	2	1.95	6	50	6	1	●
SH260-BN2-2-8-H	2	1	2	1.95	8	50	4	1	●
SH260-BN2-2-10-H	2	1	2	1.95	10	50	4	1	●
SH260-BN2-2-12-H	2	1	2	1.95	12	50	4	1	●
SH260-BN2-3-9-H	3	1.5	3	2.9	9	50	4	1	●
SH260-BN2-3-12-H	3	1.5	3	2.9	12	50	4	1	●
SH260-BN2-3-16-H-6	3	1.5	3	2.9	16	75	6	1	●
SH260-BN2-3-18-H	3	1.5	3	2.9	18	50	4	1	●
SH260-BN2-3-18-H-6	3	1.5	3	2.9	18	50	6	1	●
SH260-BN2-4-12-H	4	2	4	3.9	12	50	4	2	●
SH260-BN2-4-12-H-6	4	2	4	3.9	12	50	6	1	●
SH260-BN2-4-24-H	4	2	4	3.9	24	60	4	2	●
SH260-BN2-4-24-H-6	4	2	4	3.9	24	60	6	1	●
SH260-BN2-5-15-H	5	2.5	5	4.9	15	60	6	1	○
SH260-BN2-5-30-H	5	2.5	5	4.9	30	75	6	1	●
SH260-BN2-6-18-H	6	3	6	5.9	18	75	6	2	●
SH260-BN2-8-24-H	8	4	8	7.9	24	75	8	2	●
SH260-BN2-10-30-H	10	5	10	9.9	30	100	10	2	●
SH260-BN2-12-36-H	12	6	12	11.9	36	100	12	2	●

● Stock ○ Available upon Order

R	Tol
R ≤ 3	±0.005
R > 3	±0.008

Unit (mm)

Workpiece Material					
P			H		
1	2	3	4	5	6
Carbon Steel, Alloy Steel (< 35HRC)	Alloy Steel (35-48HRC)	PH, Ferrite, Martensite Steel (< 35HRC)	Hardened Steel (45-55HRC)	Hardened Steel (55-60HRC)	Hardened Steel (> 60HRC)
○	◎		◎	◎	○

◎ Most Suitable ○ Suitable

Recommended Cutting Data ※ P582

SH360-S2

2 Flutes, Standard Length, Square

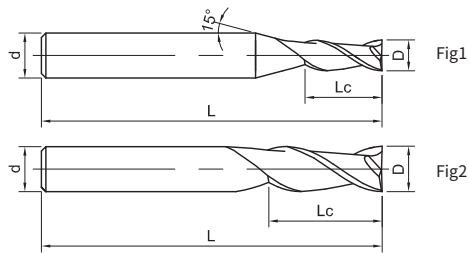

Please refer to page 167

Ordering Code	D	Lc	L	d	Figure No.	Stock
SH360-S2-1-3-K	1	3	50	4	1	●
SH360-S2-1-3-K-6	1	3	50	6	1	○
SH360-S2-1.5-4-K	1.5	4	50	4	1	●
SH360-S2-1.5-4-K-6	1.5	4	50	6	1	○
SH360-S2-2-6-K	2	6	50	4	1	●
SH360-S2-2.5-8-K	2.5	8	50	4	1	●
SH360-S2-3-8-K	3	8	50	4	1	●
SH360-S2-4-11-K	4	11	50	4	2	●
SH360-S2-3-8-K-6	3	8	50	6	1	●
SH360-S2-4-11-K-6	4	11	50	6	1	●
SH360-S2-5-13-K	5	13	50	6	1	●
SH360-S2-6-16-K	6	16	50	6	2	●
SH360-S2-7-20-K	7	20	60	8	1	●
SH360-S2-8-20-K	8	20	60	8	2	●
SH360-S2-9-22-K	9	22	75	10	1	●
SH360-S2-10-25-K	10	25	75	10	2	●
SH360-S2-12-30-K	12	30	75	12	2	●

● Stock ○ Available upon Order

D	Tol
$D \leq 6$	$\begin{matrix} 0 \\ -0.01 \end{matrix}$
$6 < D \leq 12$	$\begin{matrix} 0 \\ -0.015 \end{matrix}$
$D > 12$	$\begin{matrix} 0 \\ -0.025 \end{matrix}$

Unit(mm)

Workpiece Material

P			H		
1	2	3	4	5	6
Carbon Steel, Alloy Steel (< 35HRC)	Alloy Steel (35-48HRC)	PH, Ferrite, Martensite Steel (< 35HRC)	Hardened Steel (45-55HRC)	Hardened Steel (55-60HRC)	Hardened Steel (> 60HRC)
○	○		◎	◎	◎

◎ Most Suitable ○ Suitable

Recommended Cutting Data ※ P583

SH360-S4A

4 Flutes, Standard Length, Square

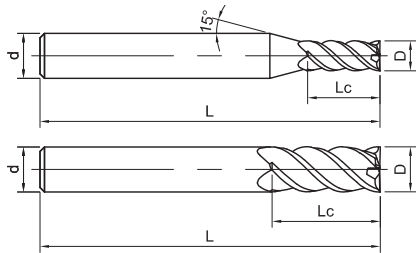

Fig1

Fig2



Please refer to page 167

Ordering Code	D	Lc	L	d	Figure No.	Stock
SH360-S4A-1-3-K	1	3	50	4	1	●
SH360-S4A-1-3-K-6	1	3	50	6	1	○
SH360-S4A-1.5-4-K	1.5	4	50	4	1	●
SH360-S4A-1.5-4-K-6	1.5	4	50	6	1	○
SH360-S4A-2-6-K	2	6	50	4	1	●
SH360-S4A-2.5-8-K	2.5	8	50	4	1	●
SH360-S4A-3-8-K	3	8	50	4	1	●
SH360-S4A-4-11-K	4	11	50	4	2	●
SH360-S4A-2-6-K-6	2	6	50	6	1	●
SH360-S4A-3-8-K-6	3	8	50	6	1	●
SH360-S4A-4-11-K-6	4	11	50	6	1	●
SH360-S4A-5-13-K	5	13	50	6	1	●
SH360-S4A-6-16-K	6	16	50	6	2	●
SH360-S4A-8-20-K	8	20	60	8	2	●
SH360-S4A-10-25-K	10	25	75	10	2	●
SH360-S4A-10-30-K	10	30	75	10	2	●
SH360-S4A-12-30-K	12	30	75	12	2	●
SH360-S4A-14-32-K	14	32	100	14	2	●
SH360-S4A-16-45-K	16	45	100	16	2	●
SH360-S4A-20-45-K	20	45	100	20	2	●

● Stock ○ Available upon Order

D	Tol
D ≤ 6	0 -0.01
6 < D ≤ 12	0 -0.015
D > 12	0 -0.025

Unit(mm)

Workpiece Material					
P			H		
1	2	3	4	5	6
Carbon Steel, Alloy Steel (< 35HRC)				Alloy Steel (35-48HRC)	PH,Ferrite, Martensite Steel (< 35HRC)
○				○	
					Hardened Steel (45-55HRC)
					Hardened Steel (55-60HRC)
					Hardened Steel (> 60HRC)
					○

○ Most Suitable ○ Suitable

Recommended Cutting Data ※ P584

SH360-SH4A

4 Flutes, Long Shank Length, Square

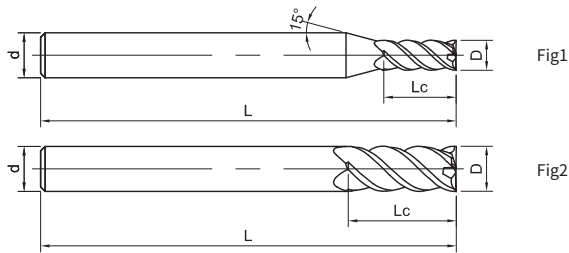

Please refer to page 167

Ordering Code	D	Lc	L	d	Figure No.	Stock
SH360-SH4A-4-60-K	4	13	60	4	2	●
SH360-SH4A-4-75-K	4	13	75	4	2	●
SH360-SH4A-4-60-K-6	4	13	60	6	1	●
SH360-SH4A-6-60-K	6	20	60	6	2	●
SH360-SH4A-6-75-K	6	20	75	6	2	●
SH360-SH4A-6-100-K	6	20	100	6	2	●
SH360-SH4A-8-75-K	8	25	75	8	2	●
SH360-SH4A-8-100-K	8	25	100	8	2	●
SH360-SH4A-10-100-K	10	30	100	10	2	●
SH360-SH4A-12-100-K	12	35	100	12	2	●

● Stock ○ Available upon Order

D	Tol
D ≤ 6	0 -0.01
6 < D ≤ 12	0 -0.015
D > 12	0 -0.025

Unit(mm)

Workpiece Material					
P			H		
1	2	3	4	5	6
Carbon Steel, Alloy Steel (< 35HRC)	Alloy Steel (35-48HRC)	PH, Ferrite, Martensite Steel (< 35HRC)	Hardened Steel (45-55HRC)	Hardened Steel (55-60HRC)	Hardened Steel (> 60HRC)
○	○		◎	◎	◎

◎ Most Suitable ○ Suitable

Recommended Cutting Data ※ P584

SH360-S6

6 Flutes, Standard Length, Square

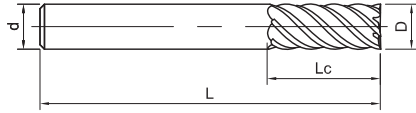

Fig1



Please refer to page 167

Ordering Code	D	Lc	L	d	Figure No.	Stock
SH360-S6-6-16-K	6	16	50	6	2	●
SH360-S6-8-20-K	8	20	60	8	2	●
SH360-S6-10-30-K	10	30	75	10	2	●
SH360-S6-12-32-K	12	32	75	12	2	●
SH360-S6-16-40-K	16	40	100	16	2	●
SH360-S6-20-45-K	20	45	100	20	2	●

● Stock ○ Available upon Order

D	Tol
D ≤ 6	0 -0.01
6 < D ≤ 12	0 -0.015
D > 12	0 -0.025

Unit(mm)

Workpiece Material					
P			H		
1 2 3 4	5	6	1	2	3 4
Carbon Steel, Alloy Steel (< 35HRC)	Alloy Steel (35-48HRC)	PH, Ferrite, Martensite Steel (< 35HRC)	Hardened Steel (45-55HRC)	Hardened Steel (55-60HRC)	Hardened Steel (> 60HRC)
○	○		◎	◎	◎

◎ Most Suitable ○ Suitable

Recommended Cutting Data ※ P584

SH360-SL6

6 Flutes, Long Flute, Square

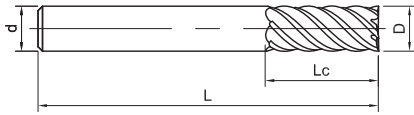

Fig1



Please refer to page 167

Ordering Code	D	Lc	L	d	Figure No.	Stock
SH360-SL6-6-24-K	6	24	75	6	1	●
SH360-SL6-8-32-K	8	32	75	8	1	●
SH360-SL6-10-40-K	10	40	100	10	1	●
SH360-SL6-12-45-K	12	45	100	12	1	●
SH360-SL6-16-64-K	16	64	150	16	1	●
SH360-SL6-20-75-K	20	75	150	20	1	●

● Stock ○ Available upon Order

D	Tol
D ≤ 6	0 -0.01
6 < D ≤ 12	0 -0.015
D > 12	0 -0.025

Unit(mm)

Workpiece Material					
P			H		
1 2 3 4	5	6	1	2	3 4
Carbon Steel, Alloy Steel (< 35HRC)	Alloy Steel (35-48HRC)	PH, Ferrite, Martensite Steel (< 35HRC)	Hardened Steel (45-55HRC)	Hardened Steel (55-60HRC)	Hardened Steel (> 60HRC)
○	○		◎	◎	◎

◎ Most Suitable ○ Suitable

Recommended Cutting Data ※ P584

SH360-R4

4 Flutes, Corner Radius

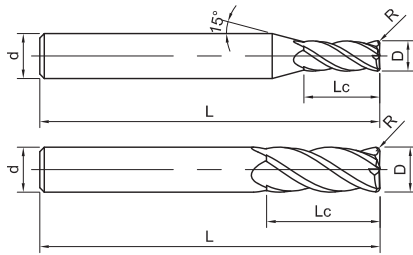

Fig1

Fig2



Please refer to page 167

Ordering Code	D	Lc	R	L	d	Figure No.	Stock
SH360-R4-1-0.2-K	1	2.5	0.2	50	4	1	●
SH360-R4-1.5-0.2-K	1.5	4	0.2	50	4	1	●
SH360-R4-2-0.2-K	2	5	0.2	50	4	1	●
SH360-R4-2-0.5-K	2	5	0.5	50	4	1	●
SH360-R4-3-0.2-K	3	8	0.2	50	4	1	●
SH360-R4-3-0.3-K	3	8	0.3	50	4	1	●
SH360-R4-3-0.3-K-3	3	8	0.3	50	3	2	●
SH360-R4-3-0.3-K-6	3	8	0.3	50	6	1	●
SH360-R4-3-0.5-K	3	8	0.5	50	4	1	●
SH360-R4-4-0.2-K	4	10	0.2	50	4	2	●
SH360-R4-4-0.3-K	4	10	0.3	50	4	2	●
SH360-R4-4-0.3-K-6	4	10	0.3	50	6	1	●
SH360-R4-4-0.5-K	4	10	0.5	50	4	2	●
SH360-R4-5-0.5-K	5	13	0.5	50	6	1	●

● Stock ○ Available upon Order

D	Tol	RTol
D ≤ 6	$\begin{matrix} 0 \\ -0.01 \end{matrix}$	±0.005
6 < D ≤ 12	$\begin{matrix} 0 \\ -0.015 \end{matrix}$	±0.007
D > 12	$\begin{matrix} 0 \\ -0.025 \end{matrix}$	±0.007

Unit (mm)

Workpiece Material					
P			H		
1 2 3 4	5	6	1	2	3 4
Carbon Steel, Alloy Steel (< 35HRC)	Alloy Steel (35-48HRC)	PH, Ferrite, Martensite Steel (< 35HRC)	Hardened Steel (45-55HRC)	Hardened Steel (55-60HRC)	Hardened Steel (> 60HRC)
○	○		◎	◎	◎

◎ Most Suitable ○ Suitable

Recommended Cutting Data ※ P584

SH360-R4

4 Flutes, Corner Radius

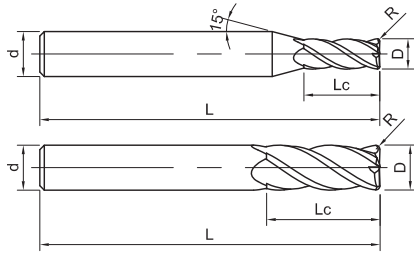

Fig1

Fig2



Please refer to page 167

» Continuation

Ordering Code	D	Lc	R	L	d	Figure No.	Stock
SH360-R4-5-1-K	5	13	1	50	6	1	○
SH360-R4-6-0.2-K	6	16	0.2	50	6	2	●
SH360-R4-6-0.3-K	6	16	0.3	50	6	2	●
SH360-R4-6-0.5-K	6	16	0.5	50	6	2	●
SH360-R4-6-1-K	6	16	1	50	6	2	●
SH360-R4-8-0.5-K	8	20	0.5	60	8	2	●
SH360-R4-8-1-K	8	20	1	60	8	2	●
SH360-R4-10-0.3-K	10	25	0.3	75	10	2	●
SH360-R4-10-0.5-K	10	25	0.5	75	10	2	●
SH360-R4-10-1-K	10	25	1	75	10	2	●
SH360-R4-12-0.5-K	12	30	0.5	75	12	2	●
SH360-R4-12-1-K	12	30	1	75	12	2	●
SH360-R4-12-2-K	12	30	2	75	12	2	●

● Stock ○ Available upon Order

D	Tol	RTol
D ≤ 6	$\begin{matrix} 0 \\ -0.01 \end{matrix}$	±0.005
6 < D ≤ 12	$\begin{matrix} 0 \\ -0.015 \end{matrix}$	±0.007
D > 12	$\begin{matrix} 0 \\ -0.025 \end{matrix}$	±0.007

Unit (mm)

Workpiece Material

P			H		
1 2 3 4	5	6	1	2	3 4
Carbon Steel, Alloy Steel (< 35HRC)	Alloy Steel (35-48HRC)	PH, Ferrite, Martensite Steel (< 35HRC)	Hardened Steel (45-55HRC)	Hardened Steel (55-60HRC)	Hardened Steel (> 60HRC)
○	○		◎	◎	◎

◎ Most Suitable ○ Suitable

Recommended Cutting Data ※ P584

SH360-RH4

4 Flutes, Corner Radius, with Long Shank Length

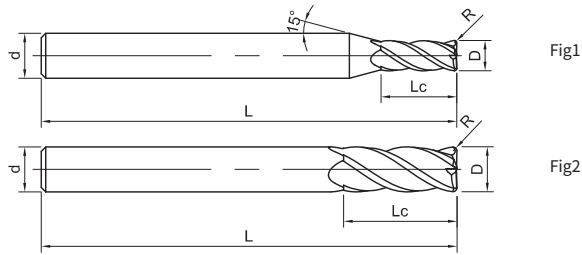

Please refer to page 167

Ordering Code	D	Lc	R	L	d	Figure No.	Stock
SH360-RH4-4-75-0.2-K-6	4	10	0.2	75	6	1	○
SH360-RH4-4-75-0.5-K	4	10	0.5	75	4	2	●
SH360-RH4-6-75-0.2-K	6	18	0.2	75	6	2	●
SH360-RH4-6-60-0.5-K	6	18	0.5	60	6	2	●
SH360-RH4-6-75-0.5-K	6	18	0.5	75	6	2	●
SH360-RH4-6-100-0.5-K	6	18	0.5	100	6	2	●
SH360-RH4-6-60-1-K	6	18	1	60	6	2	●
SH360-RH4-6-75-1-K	6	18	1	75	6	2	●
SH360-RH4-8-75-0.5-K	8	24	0.5	75	8	2	●
SH360-RH4-8-100-0.5-K	8	24	0.5	100	8	2	●
SH360-RH4-8-75-1-K	8	24	1	75	8	2	●
SH360-RH4-8-100-1-K	8	24	1	100	8	2	●
SH360-RH4-10-100-0.5-K	10	30	0.5	100	10	2	●
SH360-RH4-10-100-1-K	10	30	1	100	10	2	●
SH360-RH4-12-100-0.5-K	12	36	0.5	100	12	2	●
SH360-RH4-12-100-1-K	12	36	1	100	12	2	●

● Stock ○ Available upon Order

D	Tol	RTol
D ≤ 6	$\begin{matrix} 0 \\ -0.01 \end{matrix}$	±0.005
6 < D ≤ 12	$\begin{matrix} 0 \\ -0.015 \end{matrix}$	±0.007
D > 12	$\begin{matrix} 0 \\ -0.025 \end{matrix}$	±0.007

Unit (mm)

Workpiece Material					
P			H		
1	2	3	4	5	6
Carbon Steel, Alloy Steel (< 35HRC)	Alloy Steel (35-48HRC)	PH, Ferrite, Martensite Steel (< 35HRC)	Hardened Steel (45-55HRC)	Hardened Steel (55-60HRC)	Hardened Steel (> 60HRC)
○	○		◎	◎	◎

◎ Most Suitable ○ Suitable

Recommended Cutting Data ※ P584

SH360-B2

2 Flutes, Ballnose

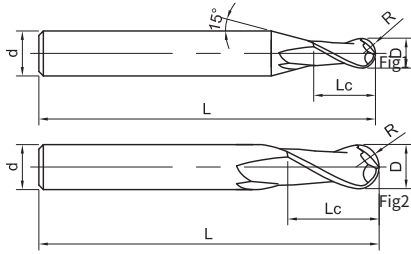

Please refer to page 167

Ordering Code	D	R	Lc	L	d	Figure No.	Stock
SH360-B2-0.6-0.9-K	0.6	0.3	0.9	50	4	1	○
SH360-B2-1-2-K	1	0.5	2	50	4	1	●
SH360-B2-1-2-K-6	1	0.5	2	50	6	1	○
SH360-B2-1.5-3-K	1.5	0.75	3	50	4	1	●
SH360-B2-1.5-3-K-6	1.5	0.75	3	50	6	1	○
SH360-B2-2-4-K	2	1	4	50	4	1	●
SH360-B2-2-4-K-6	2	1	4	50	6	1	○
SH360-B2-2.5-5-K	2.5	1.25	5	50	4	1	●
SH360-B2-3-6-K	3	1.5	6	50	4	1	●
SH360-B2-4-8-K	4	2	8	50	4	2	●
SH360-B2-3-6-K-6	3	1.5	6	50	6	1	●
SH360-B2-4-8-K-6	4	2	8	50	6	1	●
SH360-B2-5-10-K	5	2.5	10	50	6	1	●
SH360-B2-6-12-K	6	3	12	50	6	2	●
SH360-B2-7-14-K	7	3.5	14	60	8	1	●
SH360-B2-8-16-K	8	4	16	60	8	2	●
SH360-B2-10-20-K	10	5	20	75	10	2	●
SH360-B2-12-24-K	12	6	24	75	12	2	●
SH360-B2-16-32-K	16	8	32	100	16	2	●
SH360-B2-20-30-K	20	10	30	100	20	2	●

● Stock ○ Available upon Order

R	Tol
R ≤ 3	±0.005
R > 3	±0.007

Unit(mm)

Workpiece Material

P			H		
1 2 3 4	5	6	1	2	3 4
Carbon Steel, Alloy Steel (< 35HRC)	Alloy Steel (35-48HRC)	PH, Ferrite, Martensite Steel (< 35HRC)	Hardened Steel (45-55HRC)	Hardened Steel (55-60HRC)	Hardened Steel (> 60HRC)
○	○		◎	◎	◎

◎ Most Suitable ○ Suitable

Recommended Cutting Data ※ P585

SH360-BH2

2 Flutes, Ballnose, with Long Shank Length

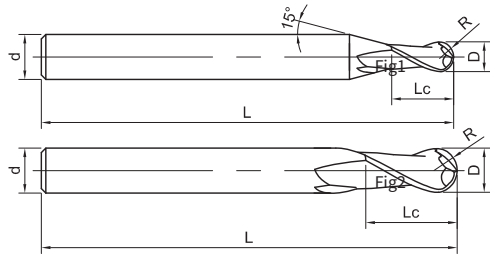

Fig1

Fig2



Please refer to page 167

Ordering Code	D	R	Lc	L	d	Figure No.	Stock
SH360-BH2-3-60-K-6	3	1.5	6	60	6	1	●
SH360-BH2-4-75-K-6	4	2	8	75	6	1	●
SH360-BH2-4-75-K	4	2	8	75	4	2	●
SH360-BH2-5-60-K	5	2.5	10	60	6	1	●
SH360-BH2-5-75-K	5	2.5	10	75	6	1	●
SH360-BH2-6-75-K	6	3	12	75	6	2	●
SH360-BH2-6-100-K	6	3	12	100	6	2	●
SH360-BH2-8-75-K	8	4	16	75	8	2	●
SH360-BH2-8-100-K	8	4	16	100	8	2	●
SH360-BH2-8-120-K	8	4	16	120	8	2	●
SH360-BH2-10-100-K	10	5	20	100	10	2	●
SH360-BH2-10-120-K	10	5	30	120	10	2	●
SH360-BH2-10-150-K	10	5	30	150	10	2	●
SH360-BH2-12-100-K	12	6	24	100	12	2	●
SH360-BH2-12-120-K	12	6	24	120	12	2	●
SH360-BH2-12-150-K	12	6	35	150	12	2	●
SH360-BH2-16-150-K	16	8	24	150	16	2	●
SH360-BH2-20-150-K	20	10	30	150	20	2	○

● Stock ○ Available upon Order

R	Tol
R ≤ 3	±0.005
R > 3	±0.007

Unit(mm)

Workpiece Material					
P			H		
1 2 3 4	5	6	1	2	3 4
Carbon Steel, Alloy Steel (< 35HRC)	Alloy Steel (35-48HRC)	PH, Ferrite, Martensite Steel (< 35HRC)	Hardened Steel (45-55HRC)	Hardened Steel (55-60HRC)	Hardened Steel (> 60HRC)
○	○		◎	◎	◎

◎ Most Suitable ○ Suitable

Recommended Cutting Data ※ P585

SH360-B4

4 Flutes, Ballnose

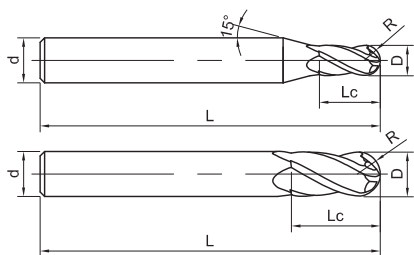

Fig1

Fig2



Please refer to page 167

Ordering Code	D	R	Lc	L	d	Figure No.	Stock
SH360-B4-3-6-K-3	3	1.5	6	50	3	2	●
SH360-B4-3-6-K-6	3	1.5	6	50	6	1	●
SH360-B4-4-8-K-6	4	2	8	50	6	1	●
SH360-B4-5-10-K	5	2.5	10	50	6	1	●
SH360-B4-6-12-K	6	3	12	50	6	2	●
SH360-B4-8-16-K	8	4	16	60	8	2	●
SH360-B4-10-20-K	10	5	20	75	10	2	●
SH360-B4-12-24-K	12	6	24	75	12	2	●
SH360-B4-16-32-K	16	8	32	100	16	2	●

● Stock ○ Available upon Order

R	Tol
R ≤ 1.5	±0.005
R ≤ 3	±0.007
R ≤ 8	±0.010

Unit(mm)

Workpiece Material					
P			H		
1 2 3 4	5	6	1	2	3 4
Carbon Steel, Alloy Steel (< 35HRC)	Alloy Steel (35-48HRC)	PH, Ferrite, Martensite Steel (< 35HRC)	Hardened Steel (45-55HRC)	Hardened Steel (55-60HRC)	Hardened Steel (> 60HRC)
○	○		◎	◎	◎

◎ Most Suitable ○ Suitable

Recommended Cutting Data ※ P586

SH360-BH4

4 Flutes, Ballnose, with Long Shank Length

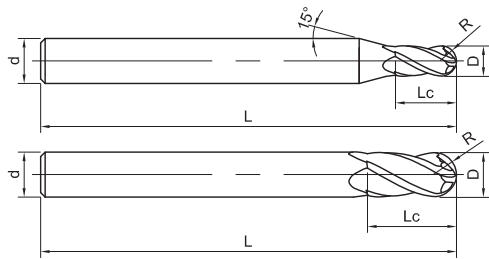

Fig1

Fig2



Please refer to page 167

Ordering Code	D	R	Lc	L	d	Figure No.	Stock
SH360-BH4-3-75-K-6	3	1.5	6	75	6	1	●
SH360-BH4-4-75-K	4	2	8	75	4	2	●
SH360-BH4-4-75-K-6	4	2	8	75	6	1	●
SH360-BH4-5-75-K	5	2.5	10	75	6	1	●
SH360-BH4-6-75-K	6	3	12	75	6	2	●
SH360-BH4-6-100-K	6	3	12	100	6	2	●
SH360-BH4-8-75-K	8	4	16	75	8	2	●
SH360-BH4-8-100-K	8	4	16	100	8	2	●
SH360-BH4-10-100-K	10	5	20	100	10	2	●
SH360-BH4-12-100-K	12	6	24	100	12	2	●

● Stock ○ Available upon Order

R	Tol
R ≤ 1.5	±0.005
R ≤ 3	±0.007
R ≤ 8	±0.010

Unit (mm)

Workpiece Material					
P			H		
1 2 3 4	5	6	1	2	3 4
Carbon Steel, Alloy Steel (< 35HRC)	Alloy Steel (35-48HRC)	PH, Ferrite, Martensite Steel (< 35HRC)	Hardened Steel (45-55HRC)	Hardened Steel (55-60HRC)	Hardened Steel (> 60HRC)
○	○		◎	◎	◎

◎ Most Suitable ○ Suitable

Recommended Cutting Data ※ P586

FH200-R4-H

4 Flutes, Corner Radius

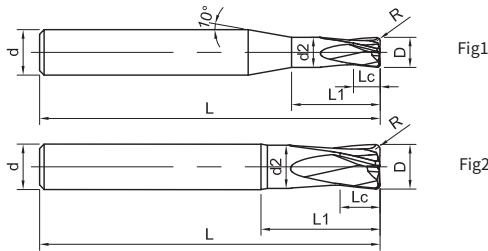

Please refer to page 167

Ordering Code	D	Lc	R	d2	L1	L	d	Figure No.	Stock
FH200-R4-01002-H	1	1	0.2	0.95	2	50	4	1	●
FH200-R4-01505-H	1.5	1.5	0.5	1.45	3	50	4	1	●
FH200-R4-02005-H	2	2	0.5	1.9	4	50	6	1	●
FH200-R4-03005-H	3	3	0.5	2.9	6	50	6	1	○
FH200-R4-04005-H	4	4	0.5	3.8	8	60	6	1	○
FH200-R4-04010-H	4	4	1	3.8	8	60	6	1	●
FH200-R4-05005-H	5	5	0.5	4.7	10	60	6	1	○
FH200-R4-05010-H	5	5	1	4.7	10	60	6	1	●
FH200-R4-06003-H	6	6	0.3	5.7	12	60	6	2	●
FH200-R4-06005-H	6	6	0.5	5.7	12	60	6	2	●
FH200-R4-06010-H	6	6	1	5.7	12	60	6	2	●
FH200-R4-06015-H	6	6	1.5	5.7	12	60	6	2	●

● Stock ○ Available upon Order

D	Tol
D ≤ 5	0 -0.01
D > 5	0 -0.015

Unit (mm)

Workpiece Material					
P			H		
1	2	3	4	5	6
Carbon Steel, Alloy Steel (< 35HRC)	Alloy Steel (35-48HRC)	PH, Ferrite, Martensite Steel (< 35HRC)	Hardened Steel (45-55HRC)	Hardened Steel (55-60HRC)	Hardened Steel (> 60HRC)
○	○	○	○	○	○

○ Most Suitable ○ Suitable

Recommended Cutting Data ※ P587

FH200-R4-H

4 Flutes, Corner Radius

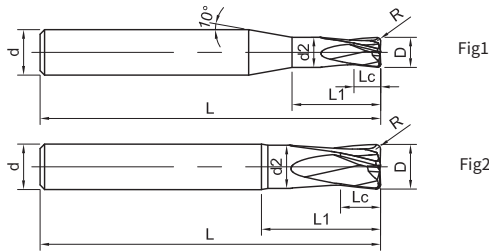

Please refer to page 167

» Continuation

Ordering Code	D	Lc	R	d2	L1	L	d	Figure No.	Stock
FH200-R4-08003-H	8	8	0.3	7.6	16	60	8	2	●
FH200-R4-08005-H	8	8	0.5	7.6	16	60	8	2	●
FH200-R4-08010-H	8	8	1	7.6	16	60	8	2	●
FH200-R4-08020-H	8	8	2	7.6	16	60	8	2	●
FH200-R4-08020E-H	8	8	2	7.6	16	75	8	2	●
FH200-R4-10005-H	10	10	0.5	9.5	20	75	10	2	●
FH200-R4-10010-H	10	10	1	9.5	20	75	10	2	●
FH200-R4-10020-H	10	10	2	9.5	20	75	10	2	●
FH200-R4-12005-H	12	12	0.5	11.5	24	75	12	2	●
FH200-R4-12010-H	12	12	1	11.5	24	75	12	2	●
FH200-R4-12020-H	12	12	2	11.5	24	75	12	2	○
FH200-R4-12030-H	12	12	3	11.5	24	75	12	2	●

● Stock ○ Available upon Order

D	Tol
D ≤ 5	0 -0.01
D > 5	0 -0.015

Unit (mm)

Workpiece Material					
P			H		
1	2	3	4	5	6
Carbon Steel, Alloy Steel (< 35HRC)	Alloy Steel (35-48HRC)	PH, Ferrite, Martensite Steel (< 35HRC)	Hardened Steel (45-55HRC)	Hardened Steel (55-60HRC)	Hardened Steel (> 60HRC)
	○		○	○	○

○ Most Suitable ○ Suitable

Recommended Cutting Data ※ P587

FH200-RN4-H

4 Flutes, Corner Radius, Long Neck

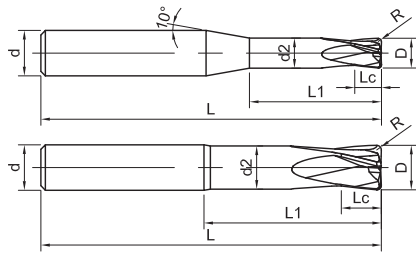

Fig1

Fig2



Please refer to page 167

Ordering Code	D	Lc	R	d2	L1	L	d	Figure No.	Stock
FH200-RN4-08005-H	8	8	0.5	7.6	24	75	8	2	●
FH200-RN4-08010-H	8	8	1	7.6	24	75	8	2	●
FH200-RN4-08020-H	8	8	2	7.6	24	75	8	2	●
FH200-RN4-10005-H	10	10	0.5	9.5	30	100	10	2	●
FH200-RN4-10010-H	10	10	1	9.5	30	100	10	2	●
FH200-RN4-10020-H	10	10	2	9.5	30	100	10	2	●
FH200-RN4-12005-H	12	12	0.5	11.5	36	100	12	2	●
FH200-RN4-12010-H	12	12	1	11.5	36	100	12	2	●
FH200-RN4-12020-H	12	12	2	11.5	36	100	12	2	●
FH200-RN4-12030-H	12	12	3	11.5	36	100	12	2	●

● Stock ○ Available upon Order

D	Tol
D ≤ 5	0 -0.01
D > 5	0 -0.015

Unit (mm)

Workpiece Material					
P			H		
1 2 3 4	5	6	1	2	3 4
Carbon Steel, Alloy Steel (< 35HRC)	Alloy Steel (35-48HRC)	PH, Ferrite, Martensite Steel (< 35HRC)	Hardened Steel (45-55HRC)	Hardened Steel (55-60HRC)	Hardened Steel (> 60HRC)
	○		○	○	○

○ Most Suitable ○ Suitable

Recommended Cutting Data ※ P587

FH200-R6-H

6 Flutes, Corner Radius

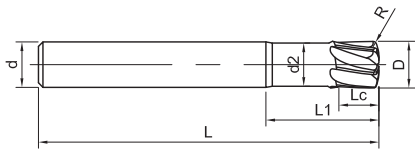

Fig1



Please refer to page 167

Ordering Code	D	Lc	R	d2	L1	L	d	Figure No.	Stock
FH200-R6-06004-H	6	5	0.375	5.5	18	60	6	1	●
FH200-R6-08005-H	8	7	0.5	7.5	24	75	8	1	●
FH200-R6-10006-H	10	8	0.625	9.5	30	90	10	1	●
FH200-R6-12008-H	12	10	0.75	11.5	36	100	12	1	○
FH200-R6-16010-H	16	14	1	15.5	48	110	16	1	●
FH200-R6-20013-H	20	18	1.25	19.5	60	125	20	1	●

● Stock ○ Available upon Order

D	Tol
D ≤ 20	-0.014 -0.038

Unit (mm)

Workpiece Material					
P			H		
1 2 3 4	5	6	1	2	3 4
Carbon Steel, Alloy Steel (< 35HRC)	Alloy Steel (35-48HRC)	PH, Ferrite, Martensite Steel (< 35HRC)	Hardened Steel (45-55HRC)	Hardened Steel (55-60HRC)	Hardened Steel (> 60HRC)
	○		○	○	○

○ Most Suitable ○ Suitable

Recommended Cutting Data ※ P587

FH200-RH6-H

6 Flutes, Corner Radius, with Long Shank Length

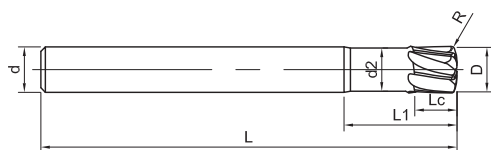

Fig1



Please refer to page 167

Ordering Code	D	Lc	R	d2	L1	L	d	Figure No.	Stock
FH200-RH6-06004-H	6	5	0.375	5.5	18	100	6	1	●
FH200-RH6-08005-H	8	7	0.5	7.5	24	100	8	1	●
FH200-RH6-10006-H	10	8	0.625	9.5	30	120	10	1	●
FH200-RH6-12008-H	12	10	0.75	11.5	36	120	12	1	○
FH200-RH6-16010-H	16	14	1	15.5	48	150	16	1	●
FH200-RH6-20013-H	20	18	1.25	19.5	60	150	20	1	●

● Stock ○ Available upon Order

D	Tol
D ≤ 20	-0.014 -0.038

Unit (mm)

Workpiece Material					
P			H		
1 2 3 4	5	6	1	2	3 4
Carbon Steel, Alloy Steel (< 35HRC)	Alloy Steel (35-48HRC)	PH, Ferrite, Martensite Steel (< 35HRC)	Hardened Steel (45-55HRC)	Hardened Steel (55-60HRC)	Hardened Steel (> 60HRC)
	○		○	○	○

○ Most Suitable ○ Suitable

Recommended Cutting Data ※ P587

FH200-RN6-H

6 Flutes, Corner Radius, Long Neck

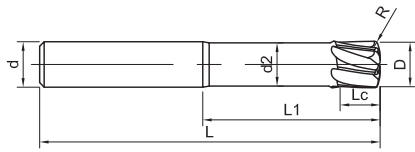

Fig1



Please refer to page 167

Ordering Code	D	Lc	R	d2	L1	L	d	Figure No.	Stock
FH200-RN6-06004-H	6	5	0.375	5.5	24	100	6	1	○
FH200-RN6-08005-H	8	7	0.5	7.5	32	100	8	1	●
FH200-RN6-10006-H	10	8	0.625	9.5	40	120	10	1	●
FH200-RN6-12008-H	12	10	0.75	11.5	48	120	12	1	●
FH200-RN6-16010-H	16	14	1	15.5	64	150	16	1	●
FH200-RN6-20013-H	20	18	1.25	19.5	80	150	20	1	○

● Stock ○ Available upon Order

D	Tol
D ≤ 20	-0.014 -0.038

Unit (mm)

Workpiece Material					
P			H		
1 2 3 4	5	6	1	2	3 4
Carbon Steel, Alloy Steel (< 35HRC)	Alloy Steel (35-48HRC)	PH, Ferrite, Martensite Steel (< 35HRC)	Hardened Steel (45-55HRC)	Hardened Steel (55-60HRC)	Hardened Steel (> 60HRC)
	○		○	○	○

○ Most Suitable ○ Suitable

Recommended Cutting Data ※ P587

SPM200-SN2

2 Flutes with Extended Neck, Square

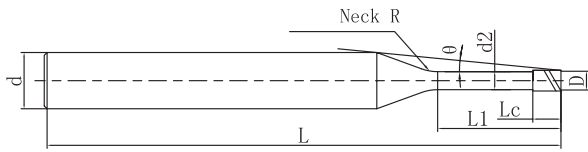

Please refer to page 167

Ordering Code	Mill Dia. D	Under Neck Length L1	Flute Length Lc	Neck Dia. d2	Overall Length L	Shank Dia. d	Neck R	Interference Angle θ	The effective under-neck length for the various draft angles					Stock	
									0.5°	1°	1.5°	2°	3°		
SPM200-SN2-0.1-0.3-V	0.1	0.3	0.15	0.08	50	4	1	14.39	0.31	0.33	0.35	0.37	0.40	●	
SPM200-SN2-0.1-0.5-V		0.5							0.52	0.55	0.58	0.60	0.65	●	
SPM200-SN2-0.1-1-V		1							1.05	1.09	1.13	1.18	1.27	●	
SPM200-SN2-0.2-0.5-V	0.2	0.5	0.3	0.17	50	4	1	14.03	0.52	0.54	0.57	0.59	0.64	●	
SPM200-SN2-0.2-1-V		1							1.04	1.08	1.12	1.16	1.26	●	
SPM200-SN2-0.2-1.5-V		1.5							1.56	1.62	1.67	1.74	1.88	●	
SPM200-SN2-0.2-2-V	2	11.79	2.08	2.15	2.23	2.31	2.50	●							
SPM200-SN2-0.2-3-V	3	10.65	3.11	3.22	3.34	3.46	3.74	○							
SPM200-SN2-0.3-1-V	0.3	1	0.45	0.27	50	4	2	13.06	1.06	1.12	1.18	1.23	1.33	●	
SPM200-SN2-0.3-1.5-V		1.5							1.59	1.67	1.74	1.81	1.95	●	
SPM200-SN2-0.3-2-V		2							11.65	2.12	2.21	2.29	2.38	2.57	●
SPM200-SN2-0.3-2.5-V		2.5							11.05	2.64	2.75	2.85	2.96	3.20	●
SPM200-SN2-0.3-3-V		3							10.51	3.16	3.28	3.40	3.53	3.82	●
SPM200-SN2-0.4-1-V	0.4	1	0.6	0.37	50	4	2	13.01	1.06	1.12	1.18	1.23	1.33	●	
SPM200-SN2-0.4-1.5-V		1.5							12.25	1.59	1.67	1.74	1.81	1.95	●
SPM200-SN2-0.4-2-V		2							11.57	2.12	2.21	2.29	2.38	2.57	●
SPM200-SN2-0.4-2.5-V		2.5							10.97	2.64	2.75	2.85	2.96	3.20	○
SPM200-SN2-0.4-3-V		3							10.42	3.16	3.28	3.40	3.53	3.82	●
SPM200-SN2-0.4-3.5-V		3.5							9.92	3.68	3.82	3.96	4.11	4.44	●
SPM200-SN2-0.4-4-V		4							9.47	4.20	4.35	4.51	4.68	5.06	●
SPM200-SN2-0.4-5-V		5							8.68	5.24	5.42	5.62	5.83	6.30	○
SPM200-SN2-0.4-6-V		6							8.01	6.27	6.49	6.73	6.98	7.55	○
SPM200-SN2-0.4-8-V		8							6.94	8.34	8.63	8.94	9.28	10.03	●
SPM200-SN2-0.4-10-V	10	6.12	10.41	10.77	11.16	11.58	12.52	○							

● Stock ○ Available upon Order

D	Tol
0.1 ≤ D ≤ 0.5	0 -0.007
0.6 ≤ D ≤ 0.9	0 -0.01
1.0 ≤ D ≤ 6.0	0 -0.015

(mm)

Recommended Cutting Data ※ P589

SPM200-SN2

2 Flutes with Extended Neck, Square

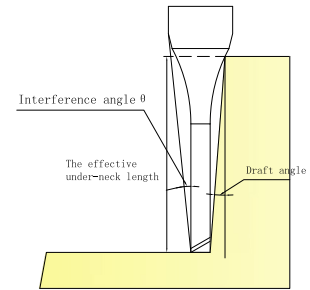
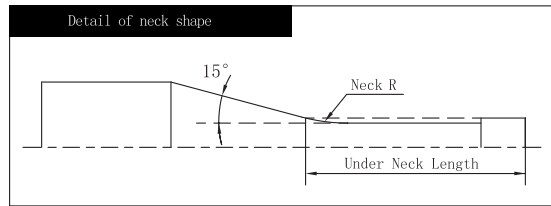

Please refer to page 167

» Continue

Ordering Code	Mill Dia. D	Under Neck Length L1	Flute Length Lc	Neck Dia. d2	Overall Length L	Shank Dia. d	Neck R	Interference Angle θ	The effective under-neck length for the various draft angles					Stock	
									0.5°	1°	1.5°	2°	3°		
SPM200-SN2-0.5-1-V	0.5	1	0.75	0.47	50	4	2	12.96	1.06	1.12	1.18	1.23	1.33	●	
SPM200-SN2-0.5-1.5-V		1.5							1.59	1.67	1.74	1.81	1.95	●	
SPM200-SN2-0.5-2-V		2							11.50	2.12	2.21	2.29	2.38	2.57	○
SPM200-SN2-0.5-2.5-V		2.5							10.88	2.64	2.75	2.85	2.96	3.20	●
SPM200-SN2-0.5-3-V		3							10.33	3.16	3.28	3.40	3.53	3.82	●
SPM200-SN2-0.5-4-V		4							9.37	4.20	4.35	4.51	4.68	5.06	●
SPM200-SN2-0.5-5-V		5							8.58	5.24	5.42	5.62	5.83	6.30	●
SPM200-SN2-0.5-6-V		6							7.91	6.27	6.49	6.73	6.98	7.55	●
SPM200-SN2-0.5-8-V		8							6.84	8.34	8.63	8.94	9.28	10.03	●
SPM200-SN2-0.5-10-V		10							6.02	10.41	10.77	11.16	11.58	12.52	●
SPM200-SN2-0.6-2-V	0.6	2	0.9	0.57	50	4	4	11.21	2.17	2.31	2.44	2.56	2.78	●	
SPM200-SN2-0.6-3-V		3							10.07	3.24	3.42	3.58	3.72	4.02	●
SPM200-SN2-0.6-4-V		4							9.13	4.30	4.51	4.69	4.87	5.26	●
SPM200-SN2-0.6-5-V		5							8.36	5.35	5.59	5.80	6.02	6.50	○
SPM200-SN2-0.6-6-V		6							7.70	6.40	6.67	6.91	7.17	7.75	●
SPM200-SN2-0.6-7-V		7							7.14	7.44	7.74	8.02	8.32	8.99	○
SPM200-SN2-0.6-8-V		8							6.66	8.49	8.81	9.12	9.47	10.23	●
SPM200-SN2-0.6-9-V		9							6.23	9.53	9.88	10.23	10.62	11.48	●
SPM200-SN2-0.6-10-V		10							5.86	10.57	10.94	11.34	11.77	12.72	○
SPM200-SN2-0.7-2-V		0.7							2	1.05	0.67	50	4	4	11.13
SPM200-SN2-0.7-4-V	4		9.02	4.30	4.51	4.69	4.87	5.26	●						
SPM200-SN2-0.7-6-V	6		7.59	6.40	6.67	6.91	7.17	7.75	○						
SPM200-SN2-0.7-8-V	8		6.54	8.49	8.81	9.12	9.47	10.23	○						
SPM200-SN2-0.7-10-V	10		5.75	10.57	10.94	11.34	11.77	12.72	●						

● Stock ○ Available upon Order

D	Tol
0.1 ≤ D ≤ 0.5	0 -0.007
0.6 ≤ D ≤ 0.9	0 -0.01
1.0 ≤ D ≤ 6.0	0 -0.015

(mm)

Recommended Cutting Data ※ P589

SPM200-SN2

2 Flutes with Extended Neck, Square

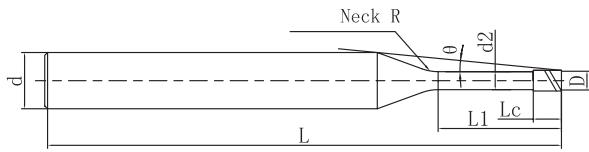

Please refer to page 167

» Continue

Ordering Code	Mill Dia. D	Under Neck Length L1	Flute Length Lc	Neck Dia. d2	Overall Length L	Shank Dia. d	Neck R	Interference Angle θ	The effective under-neck length for the various draft angles					Stock	
									0.5°	1°	1.5°	2°	3°		
SPM200-SN2-0.8-4-V	0.8	4	1.2	0.76	50	4	4	8.94	4.27	4.48	4.65	4.83	5.22	●	
SPM200-SN2-0.8-6-V		6			50				7.49	6.37	6.63	6.87	7.13	7.70	●
SPM200-SN2-0.8-8-V		8			50				6.45	8.46	8.77	9.09	9.43	10.19	●
SPM200-SN2-0.8-10-V		10			50				5.65	10.54	10.91	11.30	11.73	12.68	○
SPM200-SN2-0.8-12-V		12			55				5.04	12.61	13.05	13.52	14.03	15.16	●
SPM200-SN2-0.9-6-V	0.9	6	1.35	0.86	50	4	4	7.37	6.37	6.63	6.87	7.13	7.70	●	
SPM200-SN2-0.9-8-V		8			50				6.33	8.46	8.77	9.09	9.43	10.19	○
SPM200-SN2-0.9-10-V		10			50				5.54	10.54	10.91	11.30	11.73	12.68	●
SPM200-SN2-0.9-12-V		12			55				4.93	12.61	13.05	13.52	14.03	15.16	○
SPM200-SN2-1-2-V	1	2	1.5	0.96	50	4	4	10.89	2.15	2.29	2.41	2.52	2.73	●	
SPM200-SN2-1-3-V		3			50				9.68	3.21	3.39	3.54	3.68	3.98	●
SPM200-SN2-1-4-V		4			50				8.71	4.27	4.48	4.65	4.83	5.22	●
SPM200-SN2-1-5-V		5			50				7.91	5.32	5.56	5.76	5.98	6.46	●
SPM200-SN2-1-6-V		6			50				7.25	6.37	6.63	6.87	7.13	7.70	●
SPM200-SN2-1-7-V		7			50				6.69	7.41	7.7	7.98	8.28	8.95	●
SPM200-SN2-1-8-V		8			50				6.21	8.46	8.77	9.09	9.43	10.19	●
SPM200-SN2-1-9-V		9			50				5.79	9.50	9.84	10.19	10.58	11.43	○
SPM200-SN2-1-10-V		10			50				5.43	10.54	10.91	11.30	11.73	12.68	●
SPM200-SN2-1-12-V		12			55				4.82	12.61	13.05	13.52	14.03	15.16	●
SPM200-SN2-1-14-V		14			55				4.34	14.67	15.19	15.73	16.32	17.65	○
SPM200-SN2-1-16-V		16			55				3.94	16.74	17.33	17.95	18.62	20.14	●
SPM200-SN2-1-20-V		20			60				3.33	20.88	21.6	22.38	23.22	25.11	●
SPM200-SN2-1-25-V		25			65				2.79	26.05	26.95	27.93	28.97	-	●
SPM200-SN2-1.2-6-V		1.2			6				1.8	1.15	50	4	4	7.01	6.35

● Stock ○ Available upon Order

D	Tol
0.1 ≤ D ≤ 0.5	0 -0.007
0.6 ≤ D ≤ 0.9	0 -0.01
1.0 ≤ D ≤ 6.0	0 -0.015

(mm)

Recommended Cutting Data ※ P589

SPM200-SN2

2 Flutes with Extended Neck, Square

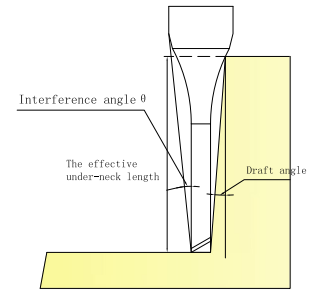
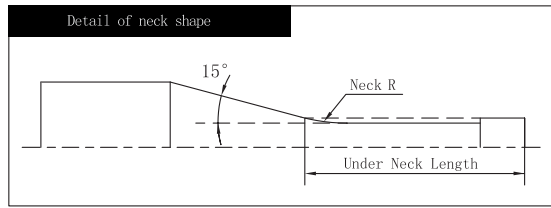

Please refer to page 167

» Continue

Ordering Code	Mill Dia. D	Under Neck Length L1	Flute Length Lc	Neck Dia. d2	Overall Length L	Shank Dia. d	Neck R	Interference Angle θ	The effective under-neck length for the various draft angles					Stock
									0.5°	1°	1.5°	2°	3°	
SPM200-SN2-1.2-8-V	1.2	8	1.8	1.15	50	4	4	5.97	8.43	8.74	9.05	9.39	10.16	●
SPM200-SN2-1.2-10-V		10			5.20			10.51	10.88	11.27	11.69	12.64	●	
SPM200-SN2-1.2-12-V		12			4.61			12.58	13.02	13.49	13.99	15.13	●	
SPM200-SN2-1.2-16-V		16			3.75			16.71	17.3	17.92	18.59	20.10	○	
SPM200-SN2-1.4-6-V	1.4	6	2.1	1.34	50	4	4	6.74	6.33	6.57	6.81	7.07	7.64	●
SPM200-SN2-1.4-12-V		12			4.38			12.55	12.99	13.46	13.97	15.10	●	
SPM200-SN2-1.5-4-V	1.5	4	2.25	1.44	50	4	4	8.08	4.24	4.43	4.59	4.77	5.15	●
SPM200-SN2-1.5-6-V		6			6.60			6.33	6.57	6.81	7.07	7.64	●	
SPM200-SN2-1.5-8-V		8			5.58			8.41	8.71	9.03	9.37	10.13	●	
SPM200-SN2-1.5-10-V		10			4.83			10.48	10.85	11.24	11.67	12.61	●	
SPM200-SN2-1.5-12-V		12			4.26			12.55	12.99	13.46	13.97	15.10	●	
SPM200-SN2-1.5-14-V		14			3.81			14.62	15.13	15.68	16.26	17.58	●	
SPM200-SN2-1.5-16-V		16			3.44			16.69	17.27	17.89	18.56	20.07	○	
SPM200-SN2-1.5-18-V		18			3.14			18.76	19.41	20.11	20.86	22.56	●	
SPM200-SN2-1.5-20-V		20			2.89			20.82	21.55	22.33	23.16	-	○	
SPM200-SN2-1.5-25-V		25			2.41			25.99	26.9	27.87	28.91	-	○	
SPM200-SN2-1.5-30-V		30			2.06			31.16	32.25	33.41	34.66	-	●	
SPM200-SN2-1.5-35-V		35			1.80			36.33	37.59	38.95	-	-	●	
SPM200-SN2-1.5-40-V	40	1.60	41.50	42.94	44.49	-	-	○						
SPM200-SN2-1.6-6-V	1.6	6	2.4	1.54	50	4	4	6.45	6.33	6.57	6.81	7.07	7.64	●
SPM200-SN2-1.6-8-V		8			5.43			8.41	8.71	9.03	9.37	10.13	○	
SPM200-SN2-1.8-6-V	1.8	6	2.7	1.73	50	4	4	6.14	6.31	6.55	6.79	7.04	7.61	○
SPM200-SN2-1.8-8-V		8			5.14			8.39	8.69	9.00	9.34	10.10	○	
SPM200-SN2-2-4-V	2	4	3	1.92	50	4	4	7.27	4.21	4.39	4.55	4.72	5.11	○

● Stock ○ Available upon Order

D	Tol
0.1 ≤ D ≤ 0.5	0 -0.007
0.6 ≤ D ≤ 0.9	0 -0.01
1.0 ≤ D ≤ 6.0	0 -0.015

(mm)

Recommended Cutting Data ※ P589

SPM200-SN2

2 Flutes with Extended Neck, Square

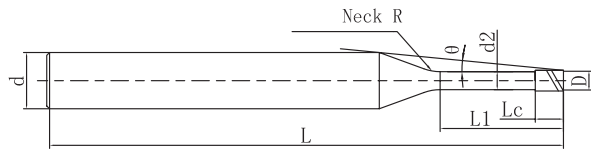

Please refer to page 167

» Continue

Ordering Code	Mill Dia. D	Under Neck Length L1	Flute Length Lc	Neck Dia. d2	Overall Length L	Shank Dia. d	Neck R	Interference Angle θ	The effective under-neck length for the various draft angles					Stock
									0.5°	1°	1.5°	2°	3°	
SPM200-SN2-2-6-V	2	6	3	1.92	50	4	4	5.81	6.30	6.53	6.77	7.02	7.59	●
SPM200-SN2-2-8-V		8			4.83			8.38	8.67	8.99	9.32	10.08	●	
SPM200-SN2-2-10-V		10			4.14			10.45	10.81	11.20	11.62	12.57	●	
SPM200-SN2-2-12-V		12			3.62			12.51	12.95	13.42	13.92	15.05	●	
SPM200-SN2-2-14-V		14			3.21			14.58	15.09	15.64	16.22	17.54	●	
SPM200-SN2-2-16-V		16			2.89			16.65	17.23	17.85	18.52	-	●	
SPM200-SN2-2-18-V		18			2.63			18.72	19.37	20.07	20.82	-	●	
SPM200-SN2-2-20-V		20			2.41			20.78	21.51	22.28	23.12	-	●	
SPM200-SN2-2-25-V		25			1.99			25.95	26.86	27.83	-	-	●	
SPM200-SN2-2-30-V		30			1.70			31.12	32.2	33.37	-	-	●	
SPM200-SN2-2-35-V		35			1.48			36.29	37.55	-	-	-	○	
SPM200-SN2-2-40-V		40			1.31			41.46	42.9	-	-	-	●	
SPM200-SN2-2-50-V		50			1.07			51.79	53.6	-	-	-	○	
SPM200-SN2-2.5-8-V		2.5			8			3.75	2.4	50	4	4	3.95	8.35
SPM200-SN2-2.5-12-V	12		2.89	12.48	12.92	13.39	13.89			-			●	
SPM200-SN2-2.5-16-V	16		2.28	16.62	17.2	17.82	18.49			-			●	
SPM200-SN2-2.5-20-V	20		1.88	20.75	21.48	22.25	-			-			○	
SPM200-SN2-2.5-30-V	30		1.31	31.09	32.17	-	-			-			●	
SPM200-SN2-2.5-40-V	40		1.01	41.43	42.87	-	-			-			○	
SPM200-SN2-2.5-50-V	50		0.82	51.76	-	-	-			-			○	
SPM200-SN2-3-8-V	3	8	4.5	2.88	55	6	4	6.27	8.33	8.62	8.93	9.26	10.02	○
SPM200-SN2-3-12-V		12			4.86			12.46	12.9	13.36	13.86	14.99	●	
SPM200-SN2-3-16-V		16			3.97			16.60	17.17	17.79	18.46	19.96	●	
SPM200-SN2-3-20-V		20			3.35			20.73	21.45	22.23	23.06	24.93	●	

● Stock ○ Available upon Order

D	Tol
0.1 ≤ D ≤ 0.5	0 -0.007
0.6 ≤ D ≤ 0.9	0 -0.01
1.0 ≤ D ≤ 6.0	0 -0.015

(mm)

Recommended Cutting Data ※ P589

SPM200-SN2

2 Flutes with Extended Neck, Square

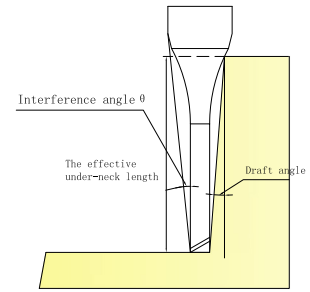
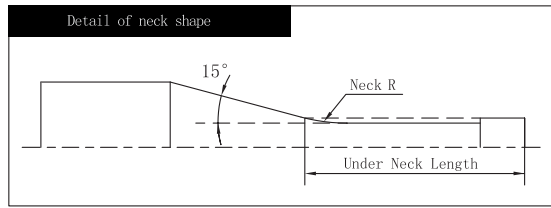

Please refer to page 167

» Continue

Ordering Code	Mill Dia. D	Under Neck Length L1	Flute Length Lc	Neck Dia. d2	Overall Length L	Shank Dia. d	Neck R	Interference Angle θ	The effective under-neck length for the various draft angles					Stock					
									0.5°	1°	1.5°	2°	3°						
SPM200-SN2-3-25-V	3	25	4.5	2.88	70	6	4	2.81	25.90	26.8	27.77	28.81	-	○					
SPM200-SN2-3-30-V		30			2.41			31.07	32.15	33.31	34.56	-	●						
SPM200-SN2-3-40-V		40			1.89			41.40	42.85	44.39	-	-	●						
SPM200-SN2-3-50-V		50			1.55			51.74	53.54	55.48	-	-	○						
SPM200-SN2-4-12-V	4	12	6	3.86	60	6	4	3.63	12.44	12.88	13.34	13.84	14.97	●					
SPM200-SN2-4-16-V		16			2.90			16.58	17.16	17.78	18.44	-	○						
SPM200-SN2-4-20-V		20			2.41			20.71	21.43	22.21	23.04	-	○						
SPM200-SN2-4-25-V		25			2.00			25.88	26.78	27.75	-	-	○						
SPM200-SN2-4-30-V		30			1.70			31.05	32.13	33.29	-	-	○						
SPM200-SN2-4-35-V		35			1.48			36.22	37.48	-	-	-	○						
SPM200-SN2-4-40-V		40			1.31			41.39	42.83	-	-	-	●						
SPM200-SN2-4-50-V		50			1.07			51.72	53.52	-	-	-	○						
SPM200-SN2-5-20-V		5			20			7.5	4.85	70	6	4	1.31	20.71	21.43	-	-	-	●
SPM200-SN2-5-25-V					25					1.07			25.87	26.78	-	-	-	○	
SPM200-SN2-5-30-V	30		0.90	31.04	-	-	-			-			○						
SPM200-SN2-5-40-V	40		0.69	41.38	-	-	-			-			●						
SPM200-SN2-5-50-V	50	0.56	51.72	-	-	-	-	○											
SPM200-SN2-6-20-V	6	20	9	5.85	70	6	-	-	-	-	-	-	-	○					
SPM200-SN2-6-30-V		30			-			-	-	-	-	-	○						
SPM200-SN2-6-40-V		40			-			-	-	-	-	-	○						
SPM200-SN2-6-50-V		50			-			-	-	-	-	-	●						

● Stock ○ Available upon Order

D	Tol
0.1 ≤ D ≤ 0.5	0 -0.007
0.6 ≤ D ≤ 0.9	0 -0.01
1.0 ≤ D ≤ 6.0	0 -0.015

(mm)

Recommended Cutting Data ※ P589

SPM200-RN2

2 Flutes with Extended Neck, Corner Radius

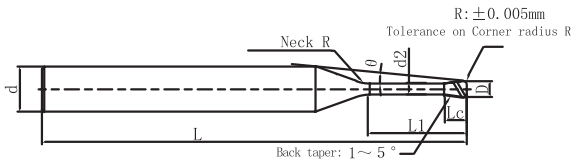

The diameter more than $\phi 4$ is not the back taper shape



Please refer to page 167

Ordering Code	Mill Dia. D	r	Under Neck Length L1	Flute Length Lc	Neck Dia. d2	Overall Length L	Shank Dia. d	Neck R	Interference Angle θ	The effective under-neck length for the various draft angles					Stock								
										0.5°	1°	1.5°	2°	3°									
SPM200-RN2-0.2-0.5-0.02-V	0.2	0.02	0.5	0.16	0.17	50	4	1	14.07	0.52	0.54	0.56	0.58	0.63	○								
SPM200-RN2-0.2-1-0.02-V			1							1.04	1.08	1.12	1.16	1.25	○								
SPM200-RN2-0.2-2-0.02-V			2							2.08	2.15	2.23	2.31	2.50	○								
SPM200-RN2-0.2-0.5-0.05-V			0.05							0.5	0.52	0.54	0.56	0.58	0.62	○							
SPM200-RN2-0.2-1-0.05-V										1	1.04	1.08	1.11	1.15	1.24	●							
SPM200-RN2-0.2-1.5-0.05-V										1.5	1.56	1.61	1.67	1.73	1.87	○							
SPM200-RN2-0.2-2-0.05-V		2								2.08	2.15	2.22	2.30	2.49	○								
SPM200-RN2-0.3-1-0.02-V		0.3								0.02	1	0.24	0.27	50	4	2	13.09	1.06	1.12	1.17	1.23	1.33	○
SPM200-RN2-0.3-2-0.02-V											2							2.11	2.21	2.29	2.38	2.57	○
SPM200-RN2-0.3-3-0.02-V			3								3.16							3.28	3.40	3.53	3.81	○	
SPM200-RN2-0.3-1-0.05-V			0.05								1							1.06	1.12	1.17	1.22	1.32	○
SPM200-RN2-0.3-1.5-0.05-V											1.5							1.59	1.66	1.73	1.80	1.94	●
SPM200-RN2-0.3-2-0.05-V	2			2.11	2.21	2.29	2.37	2.56	○														
SPM200-RN2-0.3-2.5-0.05-V	2.5			2.64	2.75	2.84	2.95	3.18	●														
SPM200-RN2-0.3-3-0.05-V	3			3.16	3.28	3.40	3.52	3.81	○														
SPM200-RN2-0.4-1-0.02-V	0.4			0.02	1	0.32	0.37	50	4	2	13.04							1.06	1.12	1.17	1.23	1.33	○
SPM200-RN2-0.4-2-0.02-V			2		2.11													2.21	2.29	2.38	2.57	○	
SPM200-RN2-0.4-3-0.02-V			3		3.16													3.28	3.40	3.53	3.81	○	
SPM200-RN2-0.4-4-0.02-V			4		4.20													4.35	4.51	4.68	5.06	○	
SPM200-RN2-0.4-1-0.05-V		0.05	1		1.06							1.12	1.17	1.22	1.32	○							
SPM200-RN2-0.4-1.5-0.05-V			1.5		1.59							1.66	1.73	1.80	1.94	○							
SPM200-RN2-0.4-2-0.05-V			2	2.11	2.21							2.29	2.37	2.56	○								
SPM200-RN2-0.4-2.5-0.05-V			2.5	2.64	2.75							2.84	2.95	3.18	○								
SPM200-RN2-0.4-3-0.05-V			3	3.16	3.28							3.40	3.52	3.81	○								

●Stock ○Available upon Order

R	Tol
R	±0.005

(mm)

Recommended Cutting Data ※ P599

SPM200-RN2

2 Flutes with Extended Neck, Corner Radius

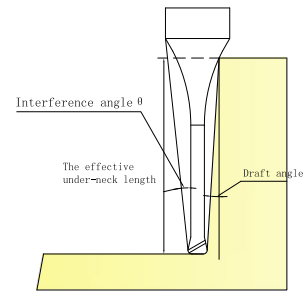
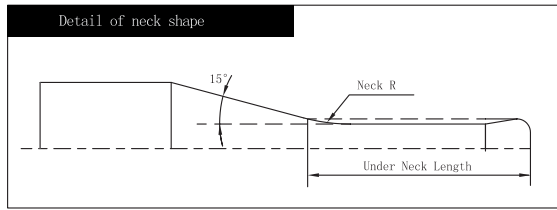

Please refer to page 167

» Continue

Ordering Code	Mill Dia. D	r	Under Neck Length L1	Flute Length Lc	Neck Dia. d2	Overall Length L	Shank Dia. d	Neck R	Interference Angle θ	The effective under-neck length for the various draft angles					Stock
										0.5°	1°	1.5°	2°	3°	
SPM200-RN2-0.4-3.5-0.05-V	0.4	0.05	3.5	0.32	0.37	50	4	2	9.97	3.68	3.82	3.95	4.10	4.43	○
SPM200-RN2-0.4-4-0.05-V			4							4.20	4.35	4.51	4.67	5.05	○
SPM200-RN2-0.4-1-0.1-V		0.1	1							1.06	1.11	1.16	1.21	1.31	○
SPM200-RN2-0.4-2-0.1-V			2							2.11	2.20	2.28	2.37	2.55	○
SPM200-RN2-0.4-3-0.1-V			3							3.16	3.28	3.39	3.52	3.79	○
SPM200-RN2-0.4-4-0.1-V			4							4.20	4.35	4.50	4.67	5.04	●
SPM200-RN2-0.5-1-0.02-V	0.5	0.02	1	0.4	0.47	50	4	2	13.00	1.06	1.12	1.17	1.23	1.33	○
SPM200-RN2-0.5-2-0.02-V			2							2.11	2.21	2.29	2.38	2.57	●
SPM200-RN2-0.5-3-0.02-V		3	3.16							3.28	3.40	3.53	3.81	○	
SPM200-RN2-0.5-4-0.02-V		4	4.20							4.35	4.51	4.68	5.06	○	
SPM200-RN2-0.5-6-0.02-V		6	7.92							6.27	6.49	6.73	6.98	7.54	●
SPM200-RN2-0.5-1-0.05-V		0.05	1							1.06	1.12	1.17	1.22	1.32	○
SPM200-RN2-0.5-2-0.05-V	2		2.11	2.21	2.29	2.37	2.56	○							
SPM200-RN2-0.5-3-0.05-V	3		3.16	3.28	3.40	3.52	3.81	○							
SPM200-RN2-0.5-4-0.05-V	4		4.20	4.35	4.51	4.67	5.05	○							
SPM200-RN2-0.5-5-0.05-V	5		8.62	5.24	5.42	5.61	5.82	6.29	○						
SPM200-RN2-0.5-6-0.05-V	6		7.94	6.27	6.49	6.72	6.97	7.53	○						
SPM200-RN2-0.5-1-0.1-V	0.1	1	1.06	1.11	1.16	1.21	1.31	○							
SPM200-RN2-0.5-2-0.1-V		2	2.11	2.20	2.28	2.37	2.55	●							
SPM200-RN2-0.5-3-0.1-V		3	3.16	3.28	3.39	3.52	3.79	○							
SPM200-RN2-0.5-4-0.1-V		4	4.20	4.35	4.50	4.67	5.04	○							
SPM200-RN2-0.5-5-0.1-V		5	8.65	5.24	5.42	5.61	5.82	6.28	○						
SPM200-RN2-0.5-6-0.1-V		6	7.97	6.27	6.49	6.72	6.97	7.52	○						
SPM200-RN2-0.6-2-0.02-V	0.6	0.02	2	0.48	0.57	50	4	4	11.24	2.17	2.31	2.44	2.55	2.77	○

● Stock ○ Available upon Order

R	Tol
R	±0.005

(mm)

Recommended Cutting Data ※ P599

SPM200-RN2

2 Flutes with Extended Neck, Corner Radius

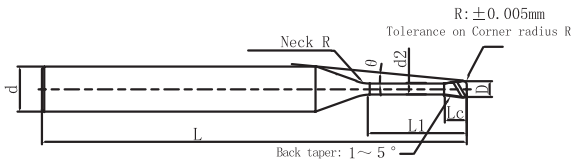

The diameter more than $\Phi 4$ is not the back taper shape



Please refer to page 167

» Continue

Ordering Code	Mill Dia. D	r	Under Neck Length L1	Flute Length Lc	Neck Dia. d2	Overall Length L	Shank Dia. d	Neck R	Interference Angle θ	The effective under-neck length for the various draft angles					Stock	
										0.5°	1°	1.5°	2°	3°		
SPM200-RN2-0.6-4-0.02-V	0.6	0.02	4	0.48	0.57	50	4	4	9.15	4.29	4.51	4.69	4.86	5.26	○	
SPM200-RN2-0.6-6-0.02-V			6							7.71	6.40	6.66	6.90	7.16	7.74	○
SPM200-RN2-0.6-2-0.05-V		0.05	2							11.27	2.17	2.31	2.43	2.55	2.76	○
SPM200-RN2-0.6-4-0.05-V			4							9.18	4.29	4.51	4.68	4.86	5.25	●
SPM200-RN2-0.6-6-0.05-V		6	7.73							6.40	6.66	6.90	7.16	7.74	○	
SPM200-RN2-0.6-8-0.05-V		8	6.68							8.49	8.80	9.12	9.46	10.22	○	
SPM200-RN2-0.6-10-0.05-V		10	5.88							10.57	10.94	11.33	11.76	12.71	○	
SPM200-RN2-0.6-2-0.1-V		0.1	2							11.34	2.16	2.30	2.43	2.54	2.75	●
SPM200-RN2-0.6-4-0.1-V			4							9.22	4.29	4.50	4.68	4.85	5.24	●
SPM200-RN2-0.6-6-0.1-V			6							7.76	6.39	6.66	6.90	7.15	7.72	○
SPM200-RN2-0.6-8-0.1-V			8							6.70	8.48	8.80	9.11	9.45	10.21	○
SPM200-RN2-0.6-10-0.1-V			10							5.89	10.57	10.94	11.33	11.75	12.70	○
SPM200-RN2-0.7-4-0.05-V	0.7		0.05	4	0.56	0.67	50	4	4	9.07	4.29	4.51	4.68	4.86	5.25	○
SPM200-RN2-0.7-6-0.05-V		6		7.62							6.40	6.66	6.90	7.16	7.74	○
SPM200-RN2-0.7-4-0.1-V		0.1	4	9.11							4.29	4.50	4.68	4.85	5.24	○
SPM200-RN2-0.7-6-0.1-V			6	7.65							6.39	6.66	6.90	7.15	7.72	○
SPM200-RN2-0.8-4-0.02-V	0.8	0.02	4	0.64	0.76	50	4	4	8.96	4.27	4.47	4.65	4.82	5.21	○	
SPM200-RN2-0.8-6-0.02-V			6							7.51	6.37	6.63	6.87	7.12	7.70	○
SPM200-RN2-0.8-4-0.05-V		0.05	4							8.99	4.27	4.47	4.65	4.82	5.21	○
SPM200-RN2-0.8-6-0.05-V			6							7.52	6.37	6.63	6.86	7.12	7.69	○
SPM200-RN2-0.8-8-0.05-V			8							6.47	8.45	8.76	9.08	9.42	10.18	○
SPM200-RN2-0.8-12-0.05-V			12							5.05	12.61	13.04	13.51	14.02	15.15	○
SPM200-RN2-0.8-4-0.1-V		0.1	4							9.03	4.26	4.47	4.64	4.81	5.19	●
SPM200-RN2-0.8-6-0.1-V			6							7.55	6.37	6.62	6.86	7.11	7.68	○

●Stock ○Available upon Order

R	Tol
R	±0.005

(mm)

Recommended Cutting Data ※ P599

SPM200-RN2

2 Flutes with Extended Neck, Corner Radius

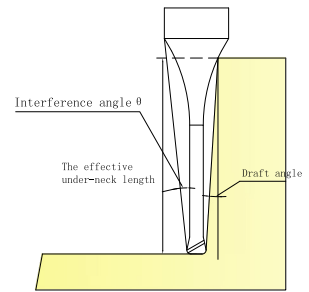
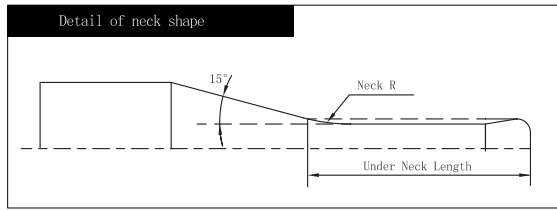

Please refer to page 167

» Continue

Ordering Code	Mill Dia. D	r	Under Neck Length L1	Flute Length Lc	Neck Dia. d2	Overall Length L	Shank Dia. d	Neck R	Interference Angle θ	The effective under-neck length for the various draft angles					Stock		
										0.5°	1°	1.5°	2°	3°			
SPM200-RN2-0.8-8-0.1-V	0.8	0.1	8	0.64	0.76	50	4	4	6.49	8.45	8.76	9.07	9.41	10.17	○		
SPM200-RN2-0.8-12-0.1-V			12			55				5.06	12.60	13.04	13.51	14.01	15.14	○	
SPM200-RN2-0.8-4-0.2-V		0.2	4			50				9.12	4.26	4.46	4.63	4.80	5.17	●	
SPM200-RN2-0.8-6-0.2-V			6			50				7.62	6.36	6.61	6.85	7.10	7.66	○	
SPM200-RN2-0.8-8-0.2-V			8			50				6.54	8.45	8.75	9.06	9.40	10.14	○	
SPM200-RN2-0.8-12-0.2-V			12			55				5.09	12.60	13.03	13.50	14.00	15.11	○	
SPM200-RN2-1-2-0.02-V	1	0.02	2	0.8	0.96	50	4	4	10.92	2.15	2.28	2.40	2.52	2.73	○		
SPM200-RN2-1-4-0.02-V			4			50				8.72	4.27	4.47	4.65	4.82	5.21	○	
SPM200-RN2-1-6-0.02-V			6			50				7.26	6.37	6.63	6.87	7.12	7.70	○	
SPM200-RN2-1-8-0.02-V			8			50				6.22	8.46	8.77	9.08	9.42	10.19	○	
SPM200-RN2-1-10-0.02-V			10			50				5.44	10.53	10.91	11.30	11.72	12.67	○	
SPM200-RN2-1-12-0.02-V			12			55				4.83	12.61	13.05	13.52	14.02	15.16	○	
SPM200-RN2-1-2-0.05-V		0.05	2			50				10.96	2.15	2.28	2.40	2.51	2.72	○	
SPM200-RN2-1-3-0.05-V			3			50				9.73	3.21	3.38	3.53	3.67	3.96	○	
SPM200-RN2-1-4-0.05-V			4			50				8.75	4.27	4.47	4.65	4.82	5.21	●	
SPM200-RN2-1-5-0.05-V			5			50				7.95	5.32	5.55	5.75	5.97	6.45	○	
SPM200-RN2-1-6-0.05-V			6			50				7.28	6.37	6.63	6.86	7.12	7.69	●	
SPM200-RN2-1-8-0.05-V			8			50				6.23	8.45	8.76	9.08	9.42	10.18	○	
SPM200-RN2-1-10-0.05-V			10			50				5.45	10.53	10.90	11.30	11.72	12.67	○	
SPM200-RN2-1-12-0.05-V			12			55				4.84	12.61	13.04	13.51	14.02	15.15	○	
SPM200-RN2-1-16-0.05-V			16			60				3.95	16.74	17.32	17.95	18.62	20.12	○	
SPM200-RN2-1-20-0.05-V			20			60				3.34	20.88	21.60	22.38	23.22	25.10	○	
SPM200-RN2-1-2-0.1-V			0.1			2				50	11.03	2.14	2.27	2.39	2.50	2.71	○
SPM200-RN2-1-3-0.1-V						3				50	9.79	3.21	3.38	3.53	3.66	3.95	○

● Stock ○ Available upon Order

R	Tol
R	±0.005

(mm)

Recommended Cutting Data ※ P599

SPM200-RN2

2 Flutes with Extended Neck, Corner Radius

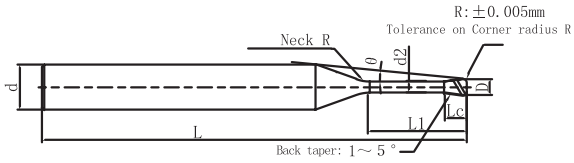

The diameter more than $\Phi 4$ is not the back taper shape



Please refer to page 167

» Continue

Ordering Code	Mill Dia. D	r	Under Neck Length L1	Flute Length Lc	Neck Dia. d2	Overall Length L	Shank Dia. d	Neck R	Interference Angle θ	The effective under-neck length for the various draft angles					Stock	
										0.5°	1°	1.5°	2°	3°		
SPM200-RN2-1-4-0.1-V	1	0.1	4	0.8	0.96	50	4	4	8.80	4.26	4.47	4.64	4.81	5.19	●	
SPM200-RN2-1-5-0.1-V			5			50			7.99	5.32	5.55	5.75	5.96	6.44	●	
SPM200-RN2-1-6-0.1-V			6			50			7.31	6.37	6.62	6.86	7.11	7.68	●	
SPM200-RN2-1-8-0.1-V			8			50			6.25	8.45	8.76	9.07	9.41	10.17	○	
SPM200-RN2-1-10-0.1-V			10			50			5.46	10.53	10.90	11.29	11.71	12.65	●	
SPM200-RN2-1-12-0.1-V			12			55			4.85	12.60	13.04	13.51	14.01	15.14	○	
SPM200-RN2-1-16-0.1-V			16			60			3.96	16.74	17.32	17.94	18.61	20.11	●	
SPM200-RN2-1-20-0.1-V			20			60			3.35	20.87	21.60	22.37	23.21	25.08	○	
SPM200-RN2-1-2-0.2-V			0.2			2			50	11.17	2.14	2.26	2.38	2.48	2.68	○
SPM200-RN2-1-3-0.2-V						3			50	9.90	3.20	3.37	3.51	3.65	3.93	○
SPM200-RN2-1-4-0.2-V		4		50	8.89	4.26	4.46	4.63	4.80	5.17	●					
SPM200-RN2-1-5-0.2-V		5		50	8.06	5.31	5.54	5.74	5.95	6.41	●					
SPM200-RN2-1-6-0.2-V		6		50	7.37	6.36	6.61	6.85	7.10	7.66	●					
SPM200-RN2-1-8-0.2-V		8		50	6.30	8.45	8.75	9.06	9.40	10.14	●					
SPM200-RN2-1-10-0.2-V		10		50	5.50	10.53	10.89	11.28	11.70	12.63	○					
SPM200-RN2-1-12-0.2-V		12		55	4.88	12.60	13.03	13.50	14.00	15.11	○					
SPM200-RN2-1-16-0.2-V		16		60	3.98	16.74	17.31	17.93	18.59	20.09	○					
SPM200-RN2-1-20-0.2-V		20		60	3.36	20.87	21.59	22.36	23.19	25.06	○					
SPM200-RN2-1-2-0.3-V		0.3	2	50	11.32	2.13	2.25	2.36	2.47	2.66	○					
SPM200-RN2-1-3-0.3-V			3	50	10.01	3.20	3.36	3.50	3.63	3.90	○					
SPM200-RN2-1-4-0.3-V	4		50	8.98	4.25	4.45	4.62	4.78	5.15	○						
SPM200-RN2-1-5-0.3-V	5		50	8.14	5.31	5.53	5.73	5.93	6.39	○						
SPM200-RN2-1-6-0.3-V	6		50	7.44	6.36	6.61	6.84	7.08	7.63	○						
SPM200-RN2-1-8-0.3-V	8		50	6.35	8.44	8.75	9.05	9.38	10.12	○						

●Stock ○Available upon Order

R	Tol
R	±0.005

(mm)

Recommended Cutting Data ※ P599

SPM200-RN2

2 Flutes with Extended Neck, Corner Radius

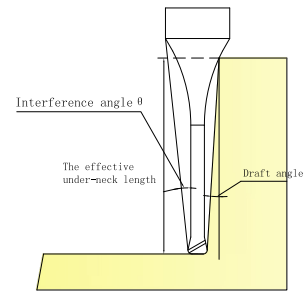
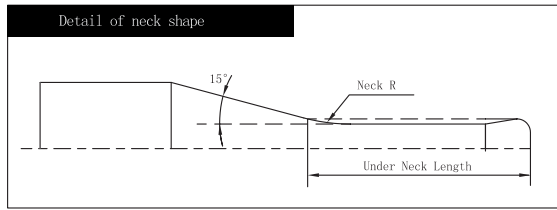

Please refer to page 167

» Continue

Ordering Code	Mill Dia. D	r	Under Neck Length L1	Flute Length Lc	Neck Dia. d2	Overall Length L	Shank Dia. d	Neck R	Interference Angle θ	The effective under-neck length for the various draft angles					Stock	
										0.5°	1°	1.5°	2°	3°		
SPM200-RN2-1-10-0.3-V	1	0.3	10	0.8	0.96	50	4	4	5.53	10.52	10.89	11.27	11.68	12.60	○	
SPM200-RN2-1-12-0.3-V			12			12.60				13.03	13.49	13.98	15.09	○		
SPM200-RN2-1-16-0.3-V			16			16.73				17.30	17.92	18.58	20.06	○		
SPM200-RN2-1-20-0.3-V			20			20.87				21.58	22.35	23.18	25.04	○		
SPM200-RN2-1.25-5-0.1-V	1.25	0.1	5	1	1.20	50	4	4	7.68	5.30	5.52	5.72	5.93	6.40	●	
SPM200-RN2-1.25-10-0.1-V			10			10.50				10.87	11.26	11.68	12.62	○		
SPM200-RN2-1.25-15-0.1-V			15			15.68				16.22	16.80	17.43	18.83	○		
SPM200-RN2-1.25-20-0.1-V			20			20.84				21.57	22.34	23.18	25.05	○		
SPM200-RN2-1.25-5-0.2-V		0.2	5			50				7.75	5.29	5.51	5.71	5.91	6.38	●
SPM200-RN2-1.25-10-0.2-V			10			50				5.21	10.50	10.86	11.25	11.66	12.59	○
SPM200-RN2-1.25-15-0.2-V			15			55				3.92	15.67	16.21	16.79	17.41	18.81	○
SPM200-RN2-1.25-20-0.2-V			20			60				3.14	20.84	21.56	22.33	23.16	25.02	○
SPM200-RN2-1.25-5-0.3-V		0.3	5			50				7.83	5.29	5.50	5.70	5.90	6.35	○
SPM200-RN2-1.25-10-0.3-V			10			50				5.24	10.50	10.86	11.24	11.65	12.57	○
SPM200-RN2-1.25-15-0.3-V			15			55				3.94	15.67	16.20	16.78	17.40	18.78	○
SPM200-RN2-1.25-20-0.3-V			20			60				3.15	20.84	21.55	22.32	23.15	25.00	○
SPM200-RN2-1.5-4-0.1-V	1.5	0.1	4	1.2	1.44	50	4	4	8.17	4.23	4.42	4.58	4.75	5.13	○	
SPM200-RN2-1.5-6-0.1-V			6			6.66				6.32	6.57	6.80	7.05	7.62	○	
SPM200-RN2-1.5-8-0.1-V			8			50				5.62	8.41	8.71	9.02	9.35	10.10	○
SPM200-RN2-1.5-12-0.1-V			12			55				4.28	12.55	12.98	13.45	13.95	15.07	●
SPM200-RN2-1.5-15-0.1-V		15	55			3.63				15.65	16.19	16.77	17.40	18.80	○	
SPM200-RN2-1.5-20-0.1-V		20	60			2.90				20.82	21.54	22.32	23.15	-	○	
SPM200-RN2-1.5-4-0.2-V		0.2	4			50				8.26	4.23	4.41	4.57	4.74	5.10	●
SPM200-RN2-1.5-6-0.2-V			6			50				6.72	6.32	6.56	6.79	7.04	7.59	●

● Stock ○ Available upon Order

R	Tol
R	±0.005

(mm)

Recommended Cutting Data ※ P599

SPM200-RN2

2 Flutes with Extended Neck, Corner Radius

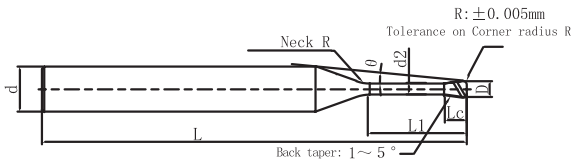

The diameter more than $\Phi 4$ is not the back taper shape



Please refer to page 167

» Continue

Ordering Code	Mill Dia. D	r	Under Neck Length L1	Flute Length Lc	Neck Dia. d2	Overall Length L	Shank Dia. d	Neck R	Interference Angle θ	The effective under-neck length for the various draft angles					Stock
										0.5°	1°	1.5°	2°	3°	
SPM200-RN2-1.5-8-0.2-V	1.5	0.2	8	1.2	1.44	50	4	4	5.66	8.40	8.70	9.01	9.34	10.08	○
SPM200-RN2-1.5-12-0.2-V			12			55			4.31	12.55	12.98	13.44	13.94	15.05	●
SPM200-RN2-1.5-15-0.2-V			15			55			3.65	15.65	16.19	16.76	17.38	18.78	○
SPM200-RN2-1.5-20-0.2-V			20			60			2.91	20.82	21.53	22.31	23.13	-	○
SPM200-RN2-1.5-4-0.3-V		0.3	4			50			8.36	4.22	4.40	4.56	4.72	5.08	○
SPM200-RN2-1.5-6-0.3-V			6			50			6.78	6.31	6.55	6.78	7.02	7.57	○
SPM200-RN2-1.5-8-0.3-V			8			50			5.71	8.40	8.69	8.99	9.32	10.05	○
SPM200-RN2-1.5-12-0.3-V			12			55			4.33	12.54	12.97	13.43	13.92	15.03	○
SPM200-RN2-1.5-15-0.3-V		15	55			3.67			15.64	16.18	16.75	17.37	18.76	○	
SPM200-RN2-1.5-20-0.3-V		20	60			2.92			20.81	21.53	22.29	23.12	-	○	
SPM200-RN2-1.5-4-0.5-V		0.5	4			50			8.55	4.21	4.39	4.54	4.69	5.03	○
SPM200-RN2-1.5-6-0.5-V			6			50			6.91	6.31	6.54	6.76	6.99	7.52	○
SPM200-RN2-1.5-8-0.5-V			8			50			5.80	8.39	8.68	8.97	9.29	10.00	●
SPM200-RN2-1.5-12-0.5-V			12			55			4.39	12.54	12.96	13.41	13.89	14.98	○
SPM200-RN2-1.5-15-0.5-V		15	55			3.71			15.64	16.17	16.73	17.34	18.71	○	
SPM200-RN2-1.5-20-0.5-V		20	60			2.95			20.81	21.51	22.27	23.09	-	○	
SPM200-RN2-1.75-5-0.1-V	1.75	0.1	5	1.4	1.68	50	4	4	6.96	5.26	5.47	5.67	5.88	6.35	○
SPM200-RN2-1.75-10-0.1-V			10			50			4.53	10.46	10.82	11.21	11.63	12.56	○
SPM200-RN2-1.75-15-0.1-V			15			55			3.35	15.63	16.17	16.75	17.38	18.78	○
SPM200-RN2-1.75-20-0.1-V			20			60			2.66	20.80	21.52	22.29	23.13	-	○
SPM200-RN2-1.75-5-0.2-V		0.2	5			50			7.03	5.26	5.47	5.66	5.86	6.32	○
SPM200-RN2-1.75-10-0.2-V			10			50			4.56	10.46	10.82	11.20	11.61	12.54	○
SPM200-RN2-1.75-15-0.2-V			15			55			3.37	15.63	16.16	16.74	17.36	18.75	○
SPM200-RN2-1.75-20-0.2-V			20			60			2.67	20.80	21.51	22.28	23.11	-	○

●Stock ○Available upon Order

R	Tol
R	±0.005

(mm)

Recommended Cutting Data ※ P599

SPM200-RN2

2 Flutes with Extended Neck, Corner Radius

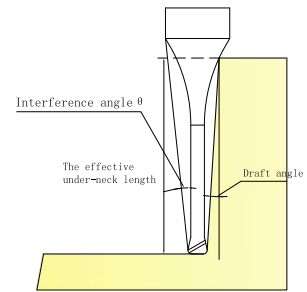
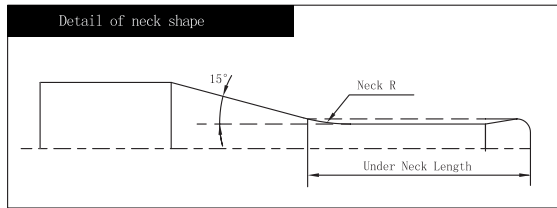

Please refer to page 167

» Continue

Ordering Code	Mill Dia. D	r	Under Neck Length L1	Flute Length Lc	Neck Dia. d2	Overall Length L	Shank Dia. d	Neck R	Interference Angle θ	The effective under-neck length for the various draft angles					Stock
										0.5°	1°	1.5°	2°	3°	
SPM200-RN2-1.75-5-0.3-V	1.75	0.3	5	1.4	1.68	50	4	4	7.11	5.25	5.46	5.65	5.85	6.30	○
SPM200-RN2-1.75-10-0.3-V			10			4.59				10.45	10.81	11.19	11.60	12.51	○
SPM200-RN2-1.75-15-0.3-V			15			3.39				15.62	16.16	16.73	17.35	18.73	○
SPM200-RN2-1.75-20-0.3-V			20			2.69				20.79	21.51	22.27	23.10	-	○
SPM200-RN2-2-4-0.1-V	2	0.1	4	1.6	1.92	50	4	4	7.36	4.21	4.38	4.54	4.71	5.08	●
SPM200-RN2-2-6-0.1-V			6			5.86				6.29	6.53	6.76	7.01	7.57	●
SPM200-RN2-2-8-0.1-V			8			4.87				8.37	8.66	8.97	9.31	10.05	●
SPM200-RN2-2-12-0.1-V			12			3.64				12.51	12.94	13.41	13.91	15.03	●
SPM200-RN2-2-16-0.1-V			16			2.90				16.65	17.22	17.84	18.51	-	○
SPM200-RN2-2-20-0.1-V			20			2.42				20.78	21.50	22.27	23.11	-	○
SPM200-RN2-2-25-0.1-V		25	2.00			25.95				26.85	27.82	-	-	○	
SPM200-RN2-2-30-0.1-V		30	1.70			31.12				32.20	33.36	-	-	○	
SPM200-RN2-2-4-0.2-V		0.2	4			7.46				4.20	4.37	4.53	4.69	5.06	●
SPM200-RN2-2-6-0.2-V			6			5.93				6.29	6.52	6.75	6.99	7.54	●
SPM200-RN2-2-8-0.2-V			8			4.91				8.37	8.66	8.96	9.29	10.03	●
SPM200-RN2-2-12-0.2-V			12			3.66				12.51	12.94	13.40	13.89	15.00	●
SPM200-RN2-2-16-0.2-V	16		2.92	16.64	17.22	17.83	18.49	-	○						
SPM200-RN2-2-20-0.2-V	20		2.43	20.78	21.49	22.26	23.09	-	○						
SPM200-RN2-2-25-0.2-V	25	2.00	25.95	26.84	27.80	-	-	●							
SPM200-RN2-2-30-0.2-V	30	1.71	31.11	32.19	33.35	-	-	●							
SPM200-RN2-2-4-0.3-V	0.3	4	7.56	4.20	4.37	4.52	4.68	5.03	○						
SPM200-RN2-2-6-0.3-V		6	5.99	6.28	6.51	6.74	6.98	7.52	○						
SPM200-RN2-2-8-0.3-V		8	4.96	8.36	8.65	8.95	9.28	10.01	○						
SPM200-RN2-2-12-0.3-V		12	3.69	12.50	12.93	13.39	13.88	14.98	○						

● Stock ○ Available upon Order

R	Tol
R	±0.005

(mm)

Recommended Cutting Data ※ P599

SPM200-RN2

2 Flutes with Extended Neck, Corner Radius

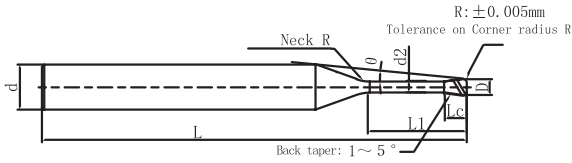

The diameter more than $\Phi 4$ is not the back taper shape



Please refer to page 167

» Continue

Ordering Code	Mill Dia. D	r	Under Neck Length L1	Flute Length Lc	Neck Dia. d2	Overall Length L	Shank Dia. d	Neck R	Interference Angle θ	The effective under-neck length for the various draft angles					Stock
										0.5°	1°	1.5°	2°	3°	
SPM200-RN2-2-16-0.3-V	2	0.3	16	1.6	1.92	55	4	4	2.93	16.64	17.21	17.82	18.48	-	○
SPM200-RN2-2-20-0.3-V			20			60			2.44	20.77	21.49	22.25	23.08	-	●
SPM200-RN2-2-25-0.3-V			25			65			2.01	25.94	26.84	27.79	28.82	-	○
SPM200-RN2-2-30-0.3-V			30			70			1.71	31.11	32.18	33.34	-	-	○
SPM200-RN2-2-6-0.5-V		0.5	6			50			6.11	6.28	6.50	6.71	6.95	7.47	○
SPM200-RN2-2-8-0.5-V			8			50			5.04	8.36	8.64	8.93	9.25	9.96	●
SPM200-RN2-2-12-0.5-V			12			55			3.73	12.50	12.92	13.36	13.85	14.93	○
SPM200-RN2-2-16-0.5-V			16			55			2.96	16.63	17.19	17.80	18.45	-	○
SPM200-RN2-2-20-0.5-V			20			60			2.46	20.77	21.47	22.23	23.05	-	○
SPM200-RN2-2-25-0.5-V			25			65			2.03	25.94	26.82	27.77	28.79	-	○
SPM200-RN2-2-30-0.5-V			30			70			1.72	31.10	32.17	33.31	-	-	○
SPM200-RN2-2-6-0.8-V			0.8			6			50	6.31	6.26	6.48	6.68	6.90	7.40
SPM200-RN2-2-8-0.8-V		8				50			5.18	8.35	8.62	8.90	9.20	9.88	○
SPM200-RN2-2-12-0.8-V		12				55			3.81	12.49	12.89	13.33	13.80	14.86	○
SPM200-RN2-2-16-0.8-V		16				55			3.01	16.62	17.17	17.77	18.40	19.83	○
SPM200-RN2-2-20-0.8-V		20				60			2.49	20.76	21.45	22.20	23.00	-	○
SPM200-RN2-2-25-0.8-V	25	65		2.05	25.93	26.80	27.74	28.75	-	○					
SPM200-RN2-2-30-0.8-V	30	70	1.74	31.09	32.15	33.28	-	-	○						
SPM200-RN2-2.5-10-0.1-V	2.5	0.1	10	2	2.40	50	4	4	3.36	10.41	10.77	11.16	11.57	12.50	○
SPM200-RN2-2.5-20-0.1-V			20			60			1.89	20.75	21.47	22.24	-	-	○
SPM200-RN2-2.5-30-0.1-V			30			70			1.32	31.09	32.17	-	-	-	●
SPM200-RN2-2.5-10-0.2-V		0.2	10			50			3.39	10.41	10.77	11.15	11.56	12.48	●
SPM200-RN2-2.5-20-0.2-V			20			60			1.90	20.75	21.46	22.23	-	-	○
SPM200-RN2-2.5-30-0.2-V			30			70			1.32	31.08	32.16	-	-	-	○

●Stock ○Available upon Order

R	Tol
R	±0.005

(mm)

Recommended Cutting Data ※ P599

SPM200-RN2

2 Flutes with Extended Neck, Corner Radius

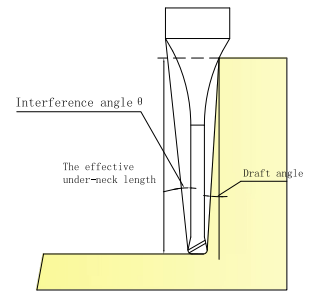
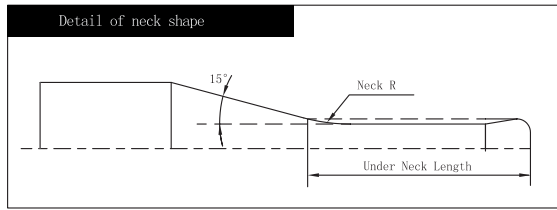

Please refer to page 167

» Continue

Ordering Code	Mill Dia. D	r	Under Neck Length L1	Flute Length Lc	Neck Dia. d2	Overall Length L	Shank Dia. d	Neck R	Interference Angle θ	The effective under-neck length for the various draft angles					Stock
										0.5°	1°	1.5°	2°	3°	
SPM200-RN2-2.5-10-0.3-V	2.5	0.3	10	2	2.40	50	4	4	3.42	10.41	10.76	11.14	11.54	12.46	○
SPM200-RN2-2.5-20-0.3-V			20			60			1.91	20.74	21.46	22.22	-	-	○
SPM200-RN2-2.5-30-0.3-V			30			70			1.32	31.08	32.15	-	-	-	○
SPM200-RN2-2.5-10-0.5-V		0.5	10			50			3.47	10.40	10.75	11.12	11.51	12.41	●
SPM200-RN2-2.5-20-0.5-V			20			60			1.92	20.74	21.44	22.20	-	-	○
SPM200-RN2-2.5-30-0.5-V			30			70			1.33	31.07	32.14	-	-	-	○
SPM200-RN2-3-6-0.1-V	3	0.1	6	2.4	2.88	50	6	4	7.40	6.25	6.47	6.70	6.95	7.50	●
SPM200-RN2-3-8-0.1-V			8			55			6.32	8.32	8.61	8.92	9.25	9.99	○
SPM200-RN2-3-12-0.1-V			12			60			4.89	12.46	12.89	13.35	13.85	14.96	○
SPM200-RN2-3-16-0.1-V			16			60			3.99	16.59	17.17	17.78	18.45	19.94	○
SPM200-RN2-3-18-0.1-V			18			65			3.65	18.66	19.31	20.00	20.75	22.42	○
SPM200-RN2-3-20-0.1-V			20			65			3.36	20.73	21.45	22.22	23.05	24.91	○
SPM200-RN2-3-30-0.1-V			30			75			2.42	31.06	32.14	33.30	34.55	-	○
SPM200-RN2-3-35-0.1-V			35			80			2.12	36.23	37.49	38.84	40.29	-	○
SPM200-RN2-3-6-0.2-V			0.2			6			50	7.46	6.25	6.46	6.69	6.93	7.48
SPM200-RN2-3-8-0.2-V		8		55	6.36	8.32	8.60	8.91	9.23	9.97	○				
SPM200-RN2-3-12-0.2-V		12		60	4.92	12.45	12.88	13.34	13.83	14.94	○				
SPM200-RN2-3-16-0.2-V		16		60	4.00	16.59	17.16	17.77	18.43	19.91	●				
SPM200-RN2-3-18-0.2-V		18		65	3.66	18.66	19.30	19.99	20.73	22.40	○				
SPM200-RN2-3-20-0.2-V		20		65	3.38	20.72	21.44	22.21	23.03	24.88	○				
SPM200-RN2-3-30-0.2-V		30		75	2.43	31.06	32.14	33.29	34.53	-	○				
SPM200-RN2-3-35-0.2-V		35		80	2.13	36.23	37.48	38.83	40.28	-	○				
SPM200-RN2-3-6-0.3-V		0.3		6	50	7.53	6.24	6.46	6.68	6.92	7.46	○			
SPM200-RN2-3-8-0.3-V			8	55	6.41	8.32	8.60	8.90	9.22	9.94	○				

● Stock ○ Available upon Order

R	Tol
R	±0.005

(mm)

Recommended Cutting Data ※ P599

SPM200-RN2

2 Flutes with Extended Neck, Corner Radius

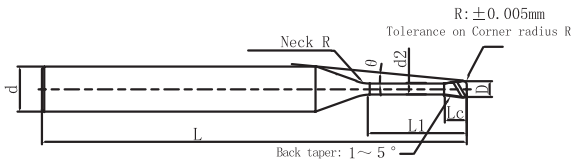

The diameter more than $\Phi 4$ is not the back taper shape



Please refer to page 167

» Continue

Ordering Code	Mill Dia. D	r	Under Neck Length L1	Flute Length Lc	Neck Dia. d2	Overall Length L	Shank Dia. d	Neck R	Interference Angle θ	The effective under-neck length for the various draft angles					Stock
										0.5°	1°	1.5°	2°	3°	
SPM200-RN2-3-12-0.3-V	3	0.3	12	2.4	2.88	60	6	4	4.94	12.45	12.87	13.33	13.82	14.91	●
SPM200-RN2-3-16-0.3-V			16			60			4.02	16.59	17.15	17.76	18.42	19.89	○
SPM200-RN2-3-18-0.3-V			18			65			3.68	18.65	19.29	19.98	20.72	22.37	●
SPM200-RN2-3-20-0.3-V			20			65			3.39	20.72	21.43	22.20	23.02	24.86	○
SPM200-RN2-3-30-0.3-V			30			75			2.43	31.06	32.13	33.28	34.52	-	●
SPM200-RN2-3-35-0.3-V			35			80			2.13	36.23	37.48	38.82	40.26	-	○
SPM200-RN2-3-8-0.5-V		0.5	8	55	6.51	8.31	8.58	8.87	9.19	9.89	○				
SPM200-RN2-3-12-0.5-V			12	60	5.00	12.44	12.86	13.31	13.79	14.87	●				
SPM200-RN2-3-16-0.5-V			16	60	4.06	16.58	17.14	17.74	18.39	19.84	●				
SPM200-RN2-3-18-0.5-V			18	65	3.71	18.65	19.28	19.96	20.69	22.33	○				
SPM200-RN2-3-20-0.5-V			20	65	3.42	20.71	21.42	22.17	22.99	24.81	○				
SPM200-RN2-3-30-0.5-V			30	75	2.45	31.05	32.12	33.26	34.49	-	●				
SPM200-RN2-3-35-0.5-V		35	80	2.14	36.22	37.46	38.80	40.23	-	○					
SPM200-RN2-3-8-1-V		1	8	55	6.76	8.29	8.55	8.82	9.11	9.77	○				
SPM200-RN2-3-12-1-V			12	60	5.15	12.43	12.83	13.25	13.71	14.74	○				
SPM200-RN2-3-16-1-V			16	60	4.16	16.56	17.10	17.69	18.31	19.72	○				
SPM200-RN2-3-18-1-V			18	65	3.79	18.63	19.24	19.90	20.61	22.20	○				
SPM200-RN2-3-20-1-V			20	65	3.49	20.70	21.38	22.12	22.91	24.69	○				
SPM200-RN2-3-30-1-V			30	75	2.48	31.03	32.08	33.20	34.41	-	○				
SPM200-RN2-3-35-1-V		35	80	2.17	36.20	37.43	38.74	40.16	-	○					
SPM200-RN2-4-8-0.1-V	4	0.1	8	3.2	3.86	55	6	4	4.90	8.31	8.59	8.90	9.23	9.97	○
SPM200-RN2-4-12-0.1-V			12			60			3.66	12.44	12.87	13.33	13.83	14.94	○
SPM200-RN2-4-16-0.1-V			16			60			2.91	16.57	17.15	17.76	18.43	-	○
SPM200-RN2-4-20-0.1-V			20			65			2.42	20.71	21.43	22.20	23.03	-	●

●Stock ○Available upon Order

R	Tol
R	±0.005

(mm)

Recommended Cutting Data ※ P599

SPM200-RN2

2 Flutes with Extended Neck, Corner Radius

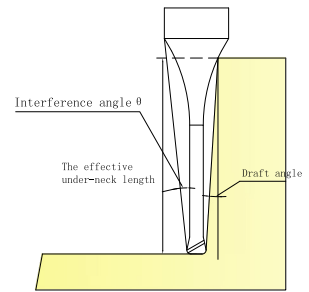
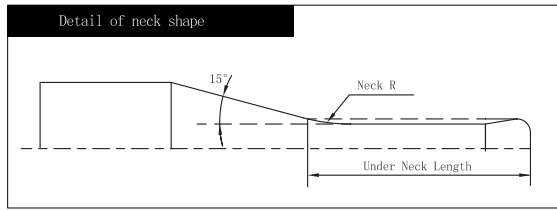

Please refer to page 167

» Continue

Ordering Code	Mill Dia. D	r	Under Neck Length L1	Flute Length Lc	Neck Dia. d2	Overall Length L	Shank Dia. d	Neck R	Interference Angle θ	The effective under-neck length for the various draft angles					Stock
										0.5°	1°	1.5°	2°	3°	
SPM200-RN2-4-30-0.1-V	4	0.1	30	3.2	3.86	75	6	4	1.71	31.05	32.12	33.28	-	-	○
SPM200-RN2-4-35-0.1-V			35			80			1.49	36.21	37.47	-	-	-	○
SPM200-RN2-4-45-0.1-V			45			90			1.18	46.55	48.17	-	-	-	○
SPM200-RN2-4-8-0.2-V		0.2	8			55			4.94	8.30	8.58	8.89	9.21	9.94	○
SPM200-RN2-4-12-0.2-V			12			60			3.68	12.44	12.86	13.32	13.81	14.92	○
SPM200-RN2-4-16-0.2-V			16			60			2.93	16.57	17.14	17.75	18.41	-	○
SPM200-RN2-4-20-0.2-V			20			65			2.43	20.71	21.42	22.19	23.01	-	○
SPM200-RN2-4-30-0.2-V			30			75			1.71	31.04	32.12	33.27	-	-	○
SPM200-RN2-4-35-0.2-V			35			80			1.49	36.21	37.47	-	-	-	○
SPM200-RN2-4-45-0.2-V		45	90			1.18			46.55	48.16	-	-	-	○	
SPM200-RN2-4-8-0.3-V		0.3	8			55			4.99	8.30	8.58	8.88	9.20	9.92	○
SPM200-RN2-4-12-0.3-V			12			60			3.70	12.43	12.86	13.31	13.80	14.89	○
SPM200-RN2-4-16-0.3-V			16			60			2.94	16.57	17.13	17.74	18.40	-	○
SPM200-RN2-4-20-0.3-V			20			65			2.44	20.70	21.41	22.18	23.00	-	○
SPM200-RN2-4-30-0.3-V			30			75			1.72	31.04	32.11	33.26	-	-	○
SPM200-RN2-4-35-0.3-V			35			80			1.49	36.21	37.46	-	-	-	○
SPM200-RN2-4-45-0.3-V		45	90			1.19			46.54	48.16	-	-	-	○	
SPM200-RN2-4-12-0.5-V		0.5	12			60			3.75	12.43	12.84	13.29	13.77	14.84	○
SPM200-RN2-4-16-0.5-V			16			60			2.97	16.56	17.12	17.72	18.37	-	○
SPM200-RN2-4-20-0.5-V			20			65			2.47	20.70	21.40	22.15	22.97	-	●
SPM200-RN2-4-30-0.5-V	30		75	1.73	31.03	32.10	33.24	-	-	○					
SPM200-RN2-4-35-0.5-V	35		80	1.50	36.20	37.44	-	-	-	○					
SPM200-RN2-4-45-0.5-V	45		90	1.19	46.54	48.14	-	-	-	●					
SPM200-RN2-4-12-1-V	1	12	60	3.88	12.41	12.81	13.23	13.69	14.72	○					

● Stock ○ Available upon Order

R	Tol
R	±0.005

(mm)

Recommended Cutting Data ※ P599

SPM200-RN2

2 Flutes with Extended Neck, Corner Radius

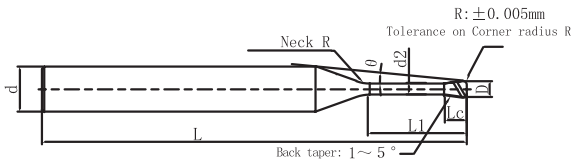

The diameter more than $\Phi 4$ is not the back taper shape



Please refer to page 167

» Continue

Ordering Code	Mill Dia. D	r	Under Neck Length L1	Flute Length Lc	Neck Dia. d2	Overall Length L	Shank Dia. d	Neck R	Interference Angle θ	The effective under-neck length for the various draft angles					Stock	
										0.5°	1°	1.5°	2°	3°		
SPM200-RN2-4-16-1-V	4	1	16	3.2	3.86	60	6	4	3.05	16.54	17.09	17.67	18.29	19.70	○	
SPM200-RN2-4-20-1-V			20			65				20.68	21.36	22.10	22.89	-	○	
SPM200-RN2-4-30-1-V			30			75				31.02	32.06	33.18	-	-	○	
SPM200-RN2-4-35-1-V			35			80				1.52	36.18	37.41	38.73	-	-	○
SPM200-RN2-4-45-1-V			45			90				1.20	46.52	48.11	-	-	-	○
SPM200-RN2-5-20-0.1-V	5	0.1	20	4	4.85	65	6	4	1.32	20.70	21.42	-	-	-	○	
SPM200-RN2-5-40-0.1-V			40			85				0.69	41.38	-	-	-	-	○
SPM200-RN2-5-20-0.2-V		0.2	20			65				1.32	20.70	21.41	-	-	-	○
SPM200-RN2-5-40-0.2-V			40			85				0.69	41.37	-	-	-	-	○
SPM200-RN2-5-20-0.3-V		0.3	20			65				1.33	20.69	21.41	-	-	-	○
SPM200-RN2-5-40-0.3-V			40			85				0.69	41.37	-	-	-	-	○
SPM200-RN2-5-20-0.5-V		0.5	20			65				1.34	20.69	21.39	-	-	-	○
SPM200-RN2-5-40-0.5-V			40			85				0.70	41.36	-	-	-	-	○
SPM200-RN2-5-20-1-V		1	20			65				1.38	20.67	21.36	-	-	-	○
SPM200-RN2-5-40-1-V			40			85				0.71	41.34	-	-	-	-	○
SPM200-RN2-6-12-0.1-V	6	0.1	12	4.8	5.85	50	6	-	-	-	-	-	-	-	○	
SPM200-RN2-6-18-0.1-V			18			60				-	-	-	-	-	○	
SPM200-RN2-6-24-0.1-V			24			70				-	-	-	-	-	○	
SPM200-RN2-6-35-0.1-V			35			80				-	-	-	-	-	○	
SPM200-RN2-6-55-0.1-V			55			100				-	-	-	-	-	○	
SPM200-RN2-6-12-0.2-V		0.2	12			50				-	-	-	-	-	○	
SPM200-RN2-6-18-0.2-V			18			60				-	-	-	-	-	○	
SPM200-RN2-6-24-0.2-V			24			70				-	-	-	-	-	○	
SPM200-RN2-6-35-0.2-V			35			80				-	-	-	-	-	○	

●Stock ○Available upon Order

R	Tol
R	±0.005

(mm)

Recommended Cutting Data ※ P599

SPM200-RN2

2 Flutes with Extended Neck, Corner Radius

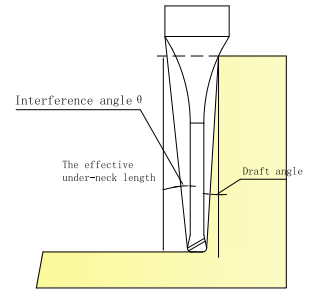
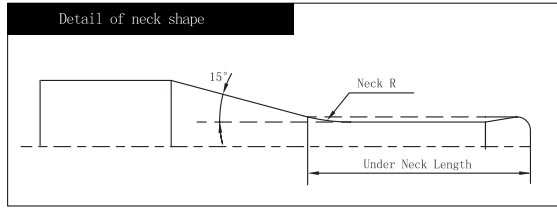

Please refer to page 167

» Continue

Ordering Code	Mill Dia. D	r	Under Neck Length L1	Flute Length Lc	Neck Dia. d2	Overall Length L	Shank Dia. d	Neck R	Interference Angle θ	The effective under-neck length for the various draft angles					Stock	
										0.5°	1°	1.5°	2°	3°		
SPM200-RN2-6-55-0.2-V	6	0.2	55	4.8	5.85	100	6	-	-	-	-	-	-	-	-	○
SPM200-RN2-6-12-0.3-V			12			50				-	-	-	-	-	○	
SPM200-RN2-6-18-0.3-V		0.3	18			60				-	-	-	-	○		
SPM200-RN2-6-24-0.3-V			24			70				-	-	-	-	○		
SPM200-RN2-6-35-0.3-V			35			80				-	-	-	-	○		
SPM200-RN2-6-55-0.3-V			55			100				-	-	-	-	○		
SPM200-RN2-6-18-0.5-V		0.5	18			60				-	-	-	-	○		
SPM200-RN2-6-24-0.5-V			24			70				-	-	-	-	○		
SPM200-RN2-6-35-0.5-V			35			80				-	-	-	-	○		
SPM200-RN2-6-55-0.5-V			55			100				-	-	-	-	○		
SPM200-RN2-6-18-1-V		1	18			60				-	-	-	-	○		
SPM200-RN2-6-24-1-V			24			70				-	-	-	-	○		
SPM200-RN2-6-35-1-V			35			80				-	-	-	-	○		
SPM200-RN2-6-55-1-V			55			100				-	-	-	-	○		

● Stock ○ Available upon Order

R	Tol
R	±0.005

(mm)

Recommended Cutting Data ※ P599

SPM200-RN4

4 Flutes with Extended Neck, Corner Radius

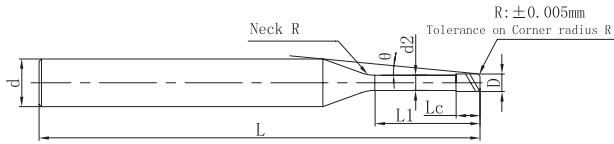

Please refer to page 167

Ordering Code	Mill Dia. D	r	Under Neck Length L1	Flute Length Lc	Neck Dia. d2	Overall Length L	Shank Dia. d	Neck R	Interference Angle θ	The effective under-neck length for the various draft angles					Stock	
										0.5°	1°	1.5°	2°	3°		
SPM200-RN4-1-4-0.05-V	1	0.05	4	0.8	0.96	50	4	4	8.75	4.27	4.47	4.65	4.82	5.21	○	
SPM200-RN4-1-6-0.05-V			6			50			7.28	6.37	6.63	6.86	7.12	7.69	○	
SPM200-RN4-1-8-0.05-V			8			50			6.23	8.45	8.76	9.08	9.42	10.18	○	
SPM200-RN4-1-10-0.05-V			10			50			5.45	10.53	10.90	11.30	11.72	12.67	○	
SPM200-RN4-1-12-0.05-V			12			60			4.84	12.61	13.04	13.51	14.02	15.15	○	
SPM200-RN4-1-16-0.05-V			16			60			3.95	16.74	17.32	17.95	18.62	20.12	○	
SPM200-RN4-1-20-0.05-V		20	60	3.34	20.88	21.60			22.38	23.22	25.10	○				
SPM200-RN4-1-4-0.1-V		0.1	4	50	8.80	4.26			4.47	4.64	4.81	5.19	○			
SPM200-RN4-1-6-0.1-V			6	50	7.31	6.37			6.62	6.86	7.11	7.68	○			
SPM200-RN4-1-8-0.1-V			8	50	6.25	8.45			8.76	9.07	9.41	10.17	○			
SPM200-RN4-1-10-0.1-V			10	50	5.46	10.53			10.90	11.29	11.71	12.65	○			
SPM200-RN4-1-12-0.1-V			12	60	4.85	12.60			13.04	13.51	14.01	15.14	○			
SPM200-RN4-1-16-0.1-V			16	60	3.96	16.74			17.32	17.94	18.61	20.11	○			
SPM200-RN4-1-20-0.1-V		20	60	3.35	20.87	21.60			22.37	23.21	25.08	○				
SPM200-RN4-1.5-4-0.05-V		1.5	0.05	4	1.2	1.42			50	8.12	4.23	4.42	4.59	4.76	5.14	○
SPM200-RN4-1.5-8-0.05-V				8					50	5.60	8.41	8.71	9.02	9.36	10.11	○
SPM200-RN4-1.5-12-0.05-V	12			60			4.27	12.55	12.99	13.46	13.96	15.09	○			
SPM200-RN4-1.5-15-0.05-V	15			60			3.62	15.65	16.20	16.78	17.41	18.82	●			
SPM200-RN4-1.5-20-0.05-V	20		60	2.89	20.82	21.55	22.32	23.16	-	○						
SPM200-RN4-1.5-4-0.1-V	0.1		4	50	8.17	4.23	4.42	4.58	4.75	5.13	○					
SPM200-RN4-1.5-8-0.1-V			8	50	5.62	8.41	8.71	9.02	9.35	10.10	●					
SPM200-RN4-1.5-12-0.1-V			12	60	4.28	12.55	12.98	13.45	13.95	15.07	●					
SPM200-RN4-1.5-15-0.1-V			15	60	3.63	15.65	16.19	16.77	17.40	18.80	○					
SPM200-RN4-1.5-20-0.1-V			20	60	2.90	20.82	21.54	22.32	23.15	-	○					

● Stock ○ Available upon Order

R	Tol
R	±0.005
D	0 -0.01

(mm)

Recommended Cutting Data ※ P621

SPM200-RN4

4 Flutes with Extended Neck, Corner Radius

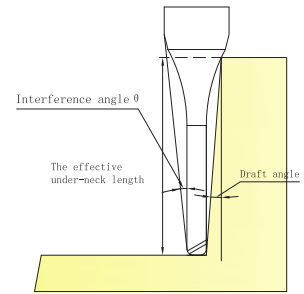
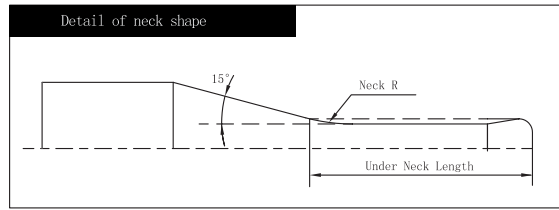

Please refer to page 167

» Continue

Ordering Code	Mill Dia. D	r	Under Neck Length L1	Flute Length Lc	Neck Dia. d2	Overall Length L	Shank Dia. d	Neck R	Interference Angle θ	The effective under-neck length for the various draft angles					Stock
										0.5°	1°	1.5°	2°	3°	
SPM200-RN4-2-4-0.05-V	2	0.05	4	1.6	1.92	50	4	4	7.32	4.21	4.39	4.55	4.72	5.09	○
SPM200-RN4-2-6-0.05-V			6			50			5.84	6.30	6.53	6.76	7.01	7.58	○
SPM200-RN4-2-8-0.05-V			8			50			4.85	8.37	8.67	8.98	9.31	10.07	○
SPM200-RN4-2-12-0.05-V			12			60			3.63	12.51	12.95	13.41	13.91	15.04	○
SPM200-RN4-2-16-0.05-V			16			60			2.90	16.65	17.23	17.85	18.51	-	○
SPM200-RN4-2-20-0.05-V			20			60			2.41	20.78	21.50	22.28	23.11	-	○
SPM200-RN4-2-4-0.1-V		0.1	4	50	7.36	4.21	4.38	4.54	4.71	5.08	○				
SPM200-RN4-2-6-0.1-V			6	50	5.86	6.29	6.53	6.76	7.01	7.57	○				
SPM200-RN4-2-8-0.1-V			8	50	4.87	8.37	8.66	8.97	9.31	10.05	○				
SPM200-RN4-2-12-0.1-V			12	60	3.64	12.51	12.94	13.41	13.91	15.03	○				
SPM200-RN4-2-16-0.1-V			16	60	2.90	16.65	17.22	17.84	18.51	-	○				
SPM200-RN4-2-20-0.1-V			20	60	2.42	20.78	21.50	22.27	23.11	-	○				
SPM200-RN4-2-4-0.2-V		0.2	4	50	7.46	4.20	4.37	4.53	4.69	5.06	○				
SPM200-RN4-2-6-0.2-V			6	50	5.93	6.29	6.52	6.75	6.99	7.54	○				
SPM200-RN4-2-8-0.2-V			8	50	4.91	8.37	8.66	8.96	9.29	10.03	●				
SPM200-RN4-2-12-0.2-V			12	60	3.66	12.51	12.94	13.40	13.89	15.00	●				
SPM200-RN4-2-16-0.2-V			16	60	2.92	16.64	17.22	17.83	18.49	-	○				
SPM200-RN4-2-20-0.2-V			20	60	2.43	20.78	21.49	22.26	23.09	-	○				
SPM200-RN4-2-25-0.2-V		25	70	2.00	25.95	26.84	27.80	-	-	○					
SPM200-RN4-2-30-0.2-V		30	70	1.71	31.11	32.19	33.35	-	-	○					
SPM200-RN4-2-4-0.3-V	0.3	4	50	7.56	4.20	4.37	4.52	4.68	5.03	○					
SPM200-RN4-2-8-0.3-V		8	50	4.96	8.36	8.65	8.95	9.28	10.01	○					
SPM200-RN4-2-12-0.3-V		12	60	3.69	12.50	12.93	13.39	13.88	14.98	○					
SPM200-RN4-2-16-0.3-V		16	60	2.93	16.64	17.21	17.82	18.48	-	○					
SPM200-RN4-2-20-0.3-V		20	60	2.44	20.77	21.49	22.25	23.08	-	○					

● Stock ○ Available upon Order

R	Tol
R	±0.005
D	0 -0.01

(mm)

Recommended Cutting Data ※ P621

SPM200-RN4

4 Flutes with Extended Neck, Corner Radius

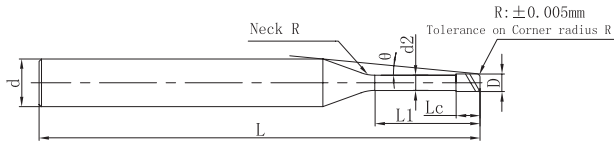

Please refer to page 167

» Continue

Ordering Code	Mill Dia. D	r	Under Neck Length L1	Flute Length Lc	Neck Dia. d2	Overall Length L	Shank Dia. d	Neck R	Interference Angle θ	The effective under-neck length for the various draft angles					Stock	
										0.5°	1°	1.5°	2°	3°		
SPM200-RN4-2-4-0.5-V	2	0.5	4	1.6	1.92	50			7.76	4.19	4.35	4.50	4.65	4.98	○	
SPM200-RN4-2-6-0.5-V			6			50				6.11	6.28	6.50	6.71	6.95	7.47	○
SPM200-RN4-2-8-0.5-V			8			50				5.04	8.36	8.64	8.93	9.25	9.96	○
SPM200-RN4-2-12-0.5-V			12			60				3.73	12.50	12.92	13.36	13.85	14.93	○
SPM200-RN4-2-16-0.5-V			16			60				2.96	16.63	17.19	17.80	18.45	-	●
SPM200-RN4-2-20-0.5-V			20			60				2.46	20.77	21.47	22.23	23.05	-	○
SPM200-RN4-2-25-0.5-V			25			70				2.03	25.94	26.82	27.77	28.79	-	○
SPM200-RN4-2-30-0.5-V			30			70				1.72	31.10	32.17	33.31	-	-	○
SPM200-RN4-2.5-8-0.1-V	2.5	0.1	8	2	2.4	50	4	4	3.98	8.34	8.63	8.94	9.27	10.02	○	
SPM200-RN4-2.5-16-0.1-V			16			60				2.29	16.62	17.19	17.81	18.47	-	○
SPM200-RN4-2.5-20-0.1-V			20			60				1.89	20.75	21.47	22.24	-	-	○
SPM200-RN4-2.5-8-0.2-V		0.2	8			50				4.02	8.34	8.63	8.93	9.26	9.99	○
SPM200-RN4-2.5-16-0.2-V			16			60				2.30	16.61	17.18	17.80	18.46	-	○
SPM200-RN4-2.5-20-0.2-V			20			60				1.90	20.75	21.46	22.23	-	-	○
SPM200-RN4-2.5-12-0.3-V			0.3			12				60	2.95	12.47	12.90	13.35	13.84	-
SPM200-RN4-2.5-20-0.3-V		20				60				1.91	20.74	21.46	22.22	-	-	○
SPM200-RN4-2.5-12-0.5-V		0.5	12			60				2.99	12.47	12.88	13.33	13.81	-	○
SPM200-RN4-2.5-20-0.5-V			20			60				1.92	20.74	21.44	22.20	-	-	○
SPM200-RN4-3-8-0.1-V	3	0.1	8	2.4	2.88	60	6		6.32	8.32	8.61	8.92	9.25	9.99	○	
SPM200-RN4-3-16-0.1-V			16			60				3.99	16.59	17.17	17.78	18.45	19.94	○
SPM200-RN4-3-25-0.1-V			25			70				2.82	25.90	26.79	27.76	28.80	-	○
SPM200-RN4-3-30-0.1-V		30	80			2.42				31.06	32.14	33.30	34.55	-	●	
SPM200-RN4-3-8-0.2-V		0.2	8			60				6.36	8.32	8.60	8.91	9.23	9.97	○
SPM200-RN4-3-12-0.2-V			12			60				4.92	12.45	12.88	13.34	13.83	14.94	○

● Stock ○ Available upon Order

R	Tol
R	±0.005
D	0 -0.01

(mm)

Recommended Cutting Data ※ P621

SPM200-RN4

4 Flutes with Extended Neck, Corner Radius

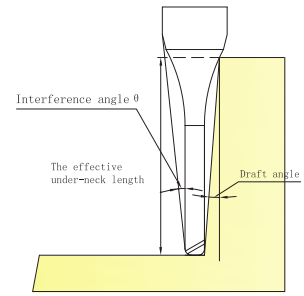
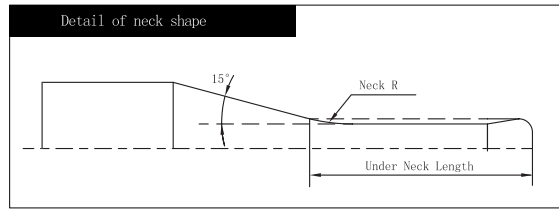

Please refer to page 167

» Continue

Ordering Code	Mill Dia. D	r	Under Neck Length L1	Flute Length Lc	Neck Dia. d2	Overall Length L	Shank Dia. d	Neck R	Interference Angle θ	The effective under-neck length for the various draft angles					Stock
										0.5°	1°	1.5°	2°	3°	
SPM200-RN4-3-16-0.2-V	3	0.2	16	2.4	2.88	60	6	4	4.00	16.59	17.16	17.77	18.43	19.91	●
SPM200-RN4-3-20-0.2-V			20			70			3.38	20.72	21.44	22.21	23.03	24.88	○
SPM200-RN4-3-25-0.2-V			25			70			2.82	25.89	26.79	27.75	28.78	-	○
SPM200-RN4-3-30-0.2-V			30			80			2.43	31.06	32.14	33.29	34.53	-	○
SPM200-RN4-3-8-0.3-V		0.3	8			60			6.41	8.32	8.60	8.90	9.22	9.94	○
SPM200-RN4-3-16-0.3-V			16			60			4.02	16.59	17.15	17.76	18.42	19.89	○
SPM200-RN4-3-20-0.3-V			20			70			3.39	20.72	21.43	22.20	23.02	24.86	○
SPM200-RN4-3-25-0.3-V			25			70			2.83	25.89	26.78	27.74	28.77	-	○
SPM200-RN4-3-30-0.3-V		30	80			2.43			31.06	32.13	33.28	34.52	-	○	
SPM200-RN4-3-8-0.5-V		0.5	8			60			6.51	8.31	8.58	8.87	9.19	9.89	○
SPM200-RN4-3-12-0.5-V			12			60			5.00	12.44	12.86	13.31	13.79	14.87	○
SPM200-RN4-3-16-0.5-V			16			60			4.06	16.58	17.14	17.74	18.39	19.84	●
SPM200-RN4-3-20-0.5-V			20			70			3.42	20.71	21.42	22.17	22.99	24.81	○
SPM200-RN4-3-25-0.5-V			25			70			2.85	25.88	26.77	27.72	28.74	-	○
SPM200-RN4-3-30-0.5-V			30			80			2.45	31.05	32.12	33.26	34.49	-	○
SPM200-RN4-3-35-0.5-V			35			80			2.14	36.22	37.46	38.80	40.23	-	○
SPM200-RN4-4-12-0.1-V	4		0.1	12	3.2	3.86	60	3.66	12.44	12.87	13.33	13.83	14.94	○	
SPM200-RN4-4-20-0.1-V		20		60			2.42	20.71	21.43	22.20	23.03	-	○		
SPM200-RN4-4-30-0.1-V		30		80			1.71	31.05	32.12	33.28	-	-	○		
SPM200-RN4-4-40-0.1-V		40		80			1.32	41.38	42.82	-	-	-	●		
SPM200-RN4-4-12-0.2-V		0.2	12	60			3.68	12.44	12.86	13.32	13.81	14.92	●		
SPM200-RN4-4-20-0.2-V			20	60			2.43	20.71	21.42	22.19	23.01	-	●		
SPM200-RN4-4-30-0.2-V			30	80			1.71	31.04	32.12	33.27	-	-	○		
SPM200-RN4-4-40-0.2-V			40	80			1.32	41.38	42.81	-	-	-	○		

● Stock ○ Available upon Order

R	Tol
R	±0.005
D	0 -0.01

(mm)

Recommended Cutting Data ※ P621

SPM200-RN4

4 Flutes with Extended Neck, Corner Radius

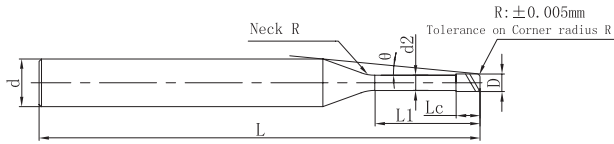

Please refer to page 167

» Continue

Ordering Code	Mill Dia. D	r	Under Neck Length L1	Flute Length Lc	Neck Dia. d2	Overall Length L	Shank Dia. d	Neck R	Interference Angle θ	The effective under-neck length for the various draft angles					Stock					
										0.5°	1°	1.5°	2°	3°						
SPM200-RN4-4-12-0.3-V	4	0.3	12	3.2	3.86	60	6	4	3.70	12.43	12.86	13.31	13.80	14.89	○					
SPM200-RN4-4-20-0.3-V			20			60			2.44	20.70	21.41	22.18	23.00	-	○					
SPM200-RN4-4-30-0.3-V			30			80			1.72	31.04	32.11	33.26	-	-	○					
SPM200-RN4-4-40-0.3-V			40			80			1.32	41.38	42.81	-	-	-	○					
SPM200-RN4-4-12-0.5-V		0.5	12			60			3.75	12.43	12.84	13.29	13.77	14.84	○					
SPM200-RN4-4-20-0.5-V			20			60			2.47	20.70	21.40	22.15	22.97	-	●					
SPM200-RN4-4-30-0.5-V			30			80			1.73	31.03	32.10	33.24	-	-	○					
SPM200-RN4-4-40-0.5-V			40			80			1.33	41.37	42.79	-	-	-	○					
SPM200-RN4-5-20-0.1-V	5	0.1	20	4	4.85	70	6	4	1.32	20.70	21.42	-	-	-	○					
SPM200-RN4-5-40-0.1-V			40			90			0.69	41.38	-	-	-	-	○					
SPM200-RN4-5-20-0.2-V		0.2	20			70			1.32	20.70	21.41	-	-	-	○					
SPM200-RN4-5-40-0.2-V			40			90			0.69	41.37	-	-	-	-	○					
SPM200-RN4-5-20-0.3-V		0.3	20			70			1.33	20.69	21.41	-	-	-	○					
SPM200-RN4-5-40-0.3-V			40			90			0.69	41.37	-	-	-	-	○					
SPM200-RN4-5-20-0.5-V		0.5	20			70			1.34	20.69	21.39	-	-	-	●					
SPM200-RN4-5-40-0.5-V			40			90			0.70	41.36	-	-	-	-	○					
SPM200-RN4-5-20-1-V		1	20			70			1.38	20.67	21.36	-	-	-	○					
SPM200-RN4-5-40-1-V			40			90			0.71	41.34	-	-	-	-	○					
SPM200-RN4-6-30-0.2-V		6	0.2			30			4.8	5.85	80	6	4	-	-	-	-	-	-	○
SPM200-RN4-6-54-0.2-V						54					100			-	-	-	-	-	-	○
SPM200-RN4-6-72-0.2-V	72			120	-	-	-	-			-			-	○					
SPM200-RN4-6-30-0.3-V	0.3		30	80	-	-	-	-			-			-	○					
SPM200-RN4-6-54-0.3-V			54	100	-	-	-	-			-			-	○					
SPM200-RN4-6-72-0.3-V			72	120	-	-	-	-			-			-	○					

● Stock ○ Available upon Order

R	Tol
R	±0.005
D	0 -0.01

(mm)

Recommended Cutting Data ※ P621

SPM200-RN4

4 Flutes with Extended Neck, Corner Radius

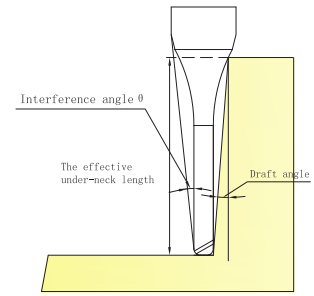
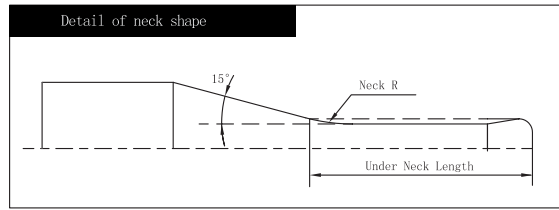

Please refer to page 167

» Continue

Ordering Code	Mill Dia. D	r	Under Neck Length L1	Flute Length Lc	Neck Dia. d2	Overall Length L	Shank Dia. d	Neck R	Interference Angle θ	The effective under-neck length for the various draft angles					Stock
										0.5°	1°	1.5°	2°	3°	
SPM200-RN4-6-30-0.5-V	6	0.5	30	4.8	5.85	80	6	4	-	-	-	-	-	-	○
SPM200-RN4-6-54-0.5-V			54			100			-	-	-	-	-	○	
SPM200-RN4-6-72-0.5-V			72			120			-	-	-	-	-	○	
SPM200-RN4-6-30-1-V		1	30			80			-	-	-	-	-	○	
SPM200-RN4-6-54-1-V			54			100			-	-	-	-	-	○	
SPM200-RN4-6-72-1-V			72			120			-	-	-	-	-	○	

● Stock ○ Available upon Order

R	Tol
R	±0.005
D	0 -0.01

(mm)

Recommended Cutting Data ※ P621

SPM200-BN2

2 Flutes with Extended Neck, Ballnose

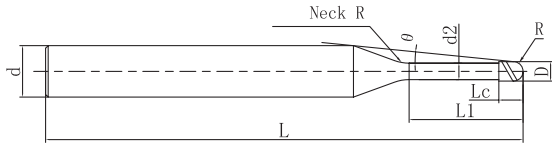

Please refer to page 167

Ordering Code	Mill Dia. D	R	Under Neck Length L1	Flute Length Lc	Neck Dia. d2	Overall Length L	Shank Dia. d	Neck R	Interference Angle θ	The effective under-neck length for the various draft angles					Stock
										0.5°	1°	1.5°	2°	3°	
SPM200-BN2-0.1-0.2-V	0.1	0.05	0.2	0.08	0.08	50	4	1	14.66	0.2	0.21	0.22	0.24	0.26	○
SPM200-BN2-0.1-0.3-V			0.3							0.31	0.33	0.34	0.36	0.39	●
SPM200-BN2-0.1-0.5-V			0.5							0.52	0.55	0.57	0.59	0.64	●
SPM200-BN2-0.2-0.5-V	0.2	0.1	0.5	0.16	0.17	50	4	1	14.21	0.51	0.53	0.55	0.57	0.61	●
SPM200-BN2-0.2-0.75-V			0.75							0.78	0.8	0.83	0.86	0.92	○
SPM200-BN2-0.2-1-V			1							1.04	1.07	1.11	1.15	1.23	●
SPM200-BN2-0.2-1.25-V			1.25							1.3	1.34	1.39	1.43	1.54	○
SPM200-BN2-0.2-1.5-V			1.5							1.56	1.61	1.66	1.72	1.85	●
SPM200-BN2-0.2-2-V			2							2.07	2.14	2.22	2.3	2.48	○
SPM200-BN2-0.2-2.5-V			2.5							2.59	2.68	2.77	2.87	3.1	○
SPM200-BN2-0.2-3-V			3							3.11	3.21	3.33	3.45	3.72	●
SPM200-BN2-0.3-0.5-V	0.3	0.15	0.5	0.24	0.27	50	4	2	14.17	0.52	0.55	0.57	0.6	0.66	●
SPM200-BN2-0.3-0.75-V			0.75							0.79	0.83	0.87	0.91	0.98	○
SPM200-BN2-0.3-1-V			1							1.05	1.11	1.16	1.2	1.29	●
SPM200-BN2-0.3-1.25-V			1.25							1.32	1.38	1.44	1.5	1.61	○
SPM200-BN2-0.3-1.5-V			1.5							1.58	1.66	1.72	1.78	1.92	●
SPM200-BN2-0.3-2-V			2							2.11	2.2	2.28	2.36	2.54	○
SPM200-BN2-0.3-2.5-V			2.5							2.63	2.74	2.83	2.93	3.16	○
SPM200-BN2-0.3-3-V	3	3.15	3.27	3.39	3.51	3.78	○								
SPM200-BN2-0.4-0.75-V	0.4	0.2	0.75	0.32	0.37	50	4	2	13.78	0.78	0.82	0.86	0.9	0.97	●
SPM200-BN2-0.4-1-V			1							1.05	1.1	1.15	1.19	1.28	●
SPM200-BN2-0.4-1.5-V			1.5							1.58	1.65	1.72	1.78	1.9	●
SPM200-BN2-0.4-2-V			2							2.11	2.19	2.27	2.35	2.53	●
SPM200-BN2-0.4-2.5-V			2.5							2.63	2.73	2.83	2.93	3.15	○

● Stock ○ Available upon Order

R	Tol
R ≤ 0.25	±0.003
R > 0.25	±0.005

(mm)

Recommended Cutting Data ※ P626

SPM200-BN2

2 Flutes with Extended Neck, Ballnose

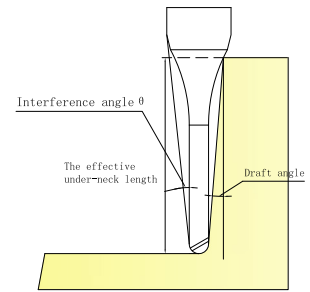
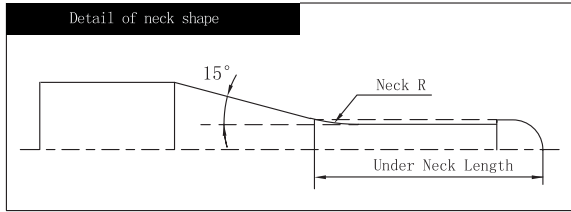

Please refer to page 167

» Continue

Ordering Code	Mill Dia. D	R	Under Neck Length L1	Flute Length Lc	Neck Dia. d2	Overall Length L	Shank Dia. d	Neck R	Interference Angle θ	The effective under-neck length for the various draft angles					Stock								
										0.5°	1°	1.5°	2°	3°									
SPM200-BN2-0.4-3-V	0.4	0.2	3	0.32	0.37	50	4	2	10.63	3.15	3.27	3.38	3.5	3.77	○								
SPM200-BN2-0.4-3.5-V			3.5							3.67	3.8	3.94	4.08	4.39	●								
SPM200-BN2-0.4-4-V			4							4.19	4.34	4.49	4.65	5.01	●								
SPM200-BN2-0.4-4.5-V			4.5							4.71	4.87	5.04	5.23	5.63	●								
SPM200-BN2-0.5-1-V	0.5	0.25	1	0.4	0.47	50	4	2	13.39	1.05	1.09	1.14	1.19	1.27	●								
SPM200-BN2-0.5-1.5-V			1.5							1.58	1.65	1.71	1.77	1.89	○								
SPM200-BN2-0.5-2-V			2							2.1	2.19	2.27	2.34	2.51	●								
SPM200-BN2-0.5-2.5-V			2.5							2.63	2.73	2.82	2.92	3.14	○								
SPM200-BN2-0.5-3-V			3							3.15	3.27	3.38	3.49	3.76	●								
SPM200-BN2-0.5-4-V			4							4.19	4.34	4.48	4.64	5	●								
SPM200-BN2-0.5-5-V			5							5.23	5.41	5.59	5.79	6.24	●								
SPM200-BN2-0.5-5.5-V			5.5							6.27	6.48	6.7	6.94	7.49	●								
SPM200-BN2-0.5-6-V			6							8.07	8.27	8.48	8.7	9.24	●								
SPM200-BN2-0.5-8-V			8							10.63	10.83	11.02	11.22	11.97	●								
SPM200-BN2-0.6-1-V			0.6							0.3	1	0.48	0.57	50	4	4	13.15	1.07	1.14	1.2	1.27	1.41	●
SPM200-BN2-0.6-2-V											2							2.15	2.28	2.39	2.5	2.7	●
SPM200-BN2-0.6-2.5-V	2.5	2.68		2.84	2.97	3.09	3.32	○															
SPM200-BN2-0.6-3-V	3	3.22		3.39	3.54	3.67	3.95	●															
SPM200-BN2-0.6-3.5-V	3.5	3.75		3.94	4.1	4.25	4.57	●															
SPM200-BN2-0.6-4-V	4	4.28		4.48	4.66	4.82	5.19	●															
SPM200-BN2-0.6-4.5-V	4.5	4.81		5.03	5.21	5.4	5.81	○															
SPM200-BN2-0.6-5-V	5	5.33		5.57	5.77	5.97	6.43	○															
SPM200-BN2-0.6-5.5-V	5.5	6.22		6.41	6.62	6.83	7.35	●															
SPM200-BN2-0.6-6-V	6	7.11		7.31	7.52	7.73	8.25	●															

● Stock ○ Available upon Order

R	Tol
R ≤ 0.25	±0.003
R > 0.25	±0.005

(mm)

Recommended Cutting Data ※ P626

SPM200-BN2

2 Flutes with Extended Neck, Ballnose

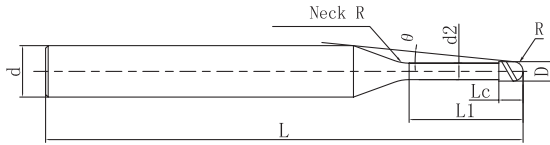

Please refer to page 167

» Continue

Ordering Code	Mill Dia. D	R	Under Neck Length L1	Flute Length Lc	Neck Dia. d2	Overall Length L	Shank Dia. d	Neck R	Interference Angle θ	The effective under-neck length for the various draft angles					Stock	
										0.5°	1°	1.5°	2°	3°		
SPM200-BN2-0.6-7-V	0.6	0.3	7	0.48	0.57	50	4	4	7.3	7.43	7.71	7.98	8.27	8.92	●	
SPM200-BN2-0.6-8-V			8							6.79	8.48	8.78	9.09	9.42	10.16	○
SPM200-BN2-0.6-9-V			9							6.35	9.52	9.85	10.2	10.57	11.4	●
SPM200-BN2-0.6-10-V			10							5.97	10.56	10.92	11.31	11.72	12.65	●
SPM200-BN2-0.6-12-V			12							5.32	12.63	13.06	13.52	14.02	15.13	●
SPM200-BN2-0.7-2-V	0.7	0.35	2	0.56	0.67	50	4	4	11.6	2.14	2.27	2.39	2.49	2.69	○	
SPM200-BN2-0.7-4-V			4							9.33	4.27	4.48	4.65	4.81	5.18	●
SPM200-BN2-0.7-6-V			6							7.81	6.38	6.64	6.87	7.11	7.66	○
SPM200-BN2-0.7-8-V			8							6.71	8.47	8.78	9.09	9.41	10.15	○
SPM200-BN2-0.8-2-V	0.8	0.4	2	0.64	0.76	50	4	4	11.64	2.12	2.24	2.35	2.45	2.63	●	
SPM200-BN2-0.8-4-V			4							9.3	4.25	4.44	4.61	4.77	5.12	●
SPM200-BN2-0.8-5-V			5							8.45	5.3	5.53	5.72	5.92	6.36	○
SPM200-BN2-0.8-6-V			6							7.74	6.35	6.6	6.83	7.07	7.61	○
SPM200-BN2-0.8-8-V			8							6.63	8.44	8.74	9.04	9.37	10.09	●
SPM200-BN2-0.8-10-V			10							5.8	10.52	10.88	11.26	11.67	12.58	●
SPM200-BN2-0.9-2-V	0.9	0.45	2	0.72	0.86	50	4	4	11.63	2.12	2.23	2.34	2.44	2.62	○	
SPM200-BN2-0.9-4-V			4							9.24	4.25	4.44	4.6	4.76	5.11	○
SPM200-BN2-0.9-6-V			6							7.66	6.35	6.6	6.82	7.06	7.6	○
SPM200-BN2-0.9-8-V			8							6.54	8.44	8.74	9.04	9.36	10.08	○
SPM200-BN2-1-2-V	1	0.5	2	0.8	0.96	50	4	4	11.62	2.12	2.23	2.33	2.43	2.61	●	
SPM200-BN2-1-3-V			3							10.25	3.18	3.34	3.48	3.6	3.85	●
SPM200-BN2-1-4-V			4							9.17	4.24	4.43	4.6	4.75	5.1	●
SPM200-BN2-1-5-V			5							8.29	5.3	5.52	5.71	5.9	6.34	●
SPM200-BN2-1-6-V			6							7.57	6.35	6.59	6.81	7.05	7.58	●

● Stock ○ Available upon Order

R	Tol
R ≤ 0.25	±0.003
R > 0.25	±0.005

(mm)

Recommended Cutting Data ※ P626

SPM200-BN2

2 Flutes with Extended Neck, Ballnose

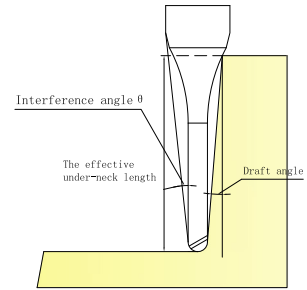
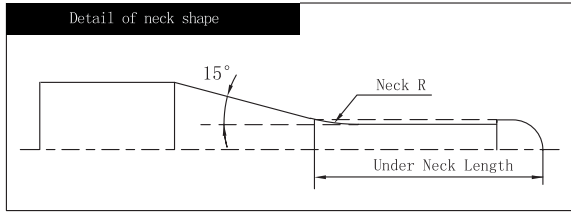

Please refer to page 167

» Continue

Ordering Code	Mill Dia. D	R	Under Neck Length L1	Flute Length Lc	Neck Dia. d2	Overall Length L	Shank Dia. d	Neck R	Interference Angle θ	The effective under-neck length for the various draft angles					Stock
										0.5°	1°	1.5°	2°	3°	
SPM200-BN2-1-7-V	1	0.5	7	0.8	0.96	50	4	4	6.96	7.39	7.66	7.92	8.2	8.83	○
SPM200-BN2-1-8-V			8			50			6.44	8.44	8.73	9.03	9.35	10.07	●
SPM200-BN2-1-9-V			9			50			5.99	9.48	9.8	10.14	10.5	11.31	○
SPM200-BN2-1-10-V			10			50			5.6	10.52	10.87	11.25	11.65	12.56	○
SPM200-BN2-1-12-V			12			55			4.96	12.59	13.01	13.46	13.95	15.04	●
SPM200-BN2-1-13-V			13			55			4.69	13.62	14.08	14.57	15.1	16.29	○
SPM200-BN2-1-14-V			14			55			4.45	14.66	15.15	15.68	16.25	17.53	○
SPM200-BN2-1-16-V			16			55			4.03	16.73	17.29	17.9	18.55	20.01	●
SPM200-BN2-1-18-V			18			60			3.69	18.79	19.43	20.11	20.85	22.5	○
SPM200-BN2-1-20-V			20			60			3.4	20.86	21.57	22.33	23.15	24.99	●
SPM200-BN2-1.1-2-V	1.1	0.55	2	0.88	1.06	50	4	4	11.61	2.11	2.22	2.32	2.42	2.6	○
SPM200-BN2-1.1-4-V			4						9.09	4.24	4.43	4.59	4.74	5.08	○
SPM200-BN2-1.1-6-V			6						7.47	6.34	6.59	6.81	7.04	7.57	○
SPM200-BN2-1.1-8-V			8						6.34	8.43	8.73	9.03	9.34	10.06	○
SPM200-BN2-1.1-10-V	10	5.5	10.51	10.87	11.24	11.64	12.54	○							
SPM200-BN2-1.2-4-V	1.2	0.6	4	0.96	1.15	50	4	4	9.05	4.22	4.4	4.55	4.7	5.04	●
SPM200-BN2-1.2-8-V			8			6.25			8.41	8.7	8.99	9.3	10.01	○	
SPM200-BN2-1.2-10-V			10			5.41			10.49	10.84	11.21	11.6	12.5	○	
SPM200-BN2-1.2-12-V			12			4.77			12.56	12.97	13.42	13.9	14.98	○	
SPM200-BN2-1.4-8-V	1.4	0.7	8	1.12	1.34	50	4	4	6.04	8.38	8.66	8.95	9.26	9.96	●
SPM200-BN2-1.4-12-V			12			4.56			12.53	12.94	13.38	13.86	14.93	○	
SPM200-BN2-1.4-16-V			16			3.67			16.66	17.22	17.82	18.46	19.9	○	
SPM200-BN2-1.5-4-V	1.5	0.75	4	1.2	1.44	50	4	4	8.82	4.2	4.36	4.51	4.65	4.97	○
SPM200-BN2-1.5-6-V			6			7.08			6.29	6.52	6.73	6.95	7.46	●	

● Stock ○ Available upon Order

R	Tol
R ≤ 0.25	±0.003
R > 0.25	±0.005

(mm)

Recommended Cutting Data ※ P626

SPM200-BN2

2 Flutes with Extended Neck, Ballnose

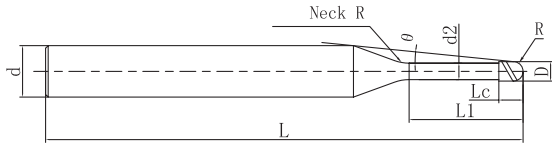

Please refer to page 167

» Continue

Ordering Code	Mill Dia. D	R	Under Neck Length L1	Flute Length Lc	Neck Dia. d2	Overall Length L	Shank Dia. d	Neck R	Interference Angle θ	The effective under-neck length for the various draft angles					Stock
										0.5°	1°	1.5°	2°	3°	
SPM200-BN2-1.5-8-V	1.5	0.75	8	1.2	1.44	50	4	4	5.92	8.38	8.66	8.95	9.25	9.94	●
SPM200-BN2-1.5-10-V			10			50			5.08	10.46	10.8	11.16	11.55	12.43	●
SPM200-BN2-1.5-12-V			12			55			4.45	12.53	12.94	13.38	13.85	14.92	●
SPM200-BN2-1.5-14-V			14			55			3.96	14.6	15.08	15.6	16.15	17.4	○
SPM200-BN2-1.5-16-V			16			55			3.57	16.66	17.22	17.81	18.45	19.89	●
SPM200-BN2-1.5-18-V			18			60			3.25	18.73	19.36	20.03	20.75	22.38	●
SPM200-BN2-1.5-20-V			20			60			2.98	20.8	21.5	22.25	23.05	-	○
SPM200-BN2-1.6-8-V	1.6	0.8	8	1.28	1.54	50	4	4	5.8	8.38	8.66	8.94	9.25	9.93	●
SPM200-BN2-1.6-12-V			12			55			4.34	12.53	12.94	13.37	13.85	14.9	○
SPM200-BN2-1.6-16-V			16			55			3.47	16.66	17.21	17.81	18.44	19.88	○
SPM200-BN2-1.6-20-V			20			60			2.89	20.8	21.49	22.24	23.04	-	○
SPM200-BN2-1.8-8-V	1.8	0.9	8	1.44	1.73	50	4	4	5.55	8.36	8.63	8.91	9.21	9.88	●
SPM200-BN2-1.8-12-V			12			55			4.11	12.5	12.91	13.34	13.81	14.85	○
SPM200-BN2-1.8-16-V			16			55			3.26	16.64	17.19	17.77	18.41	19.83	○
SPM200-BN2-1.8-20-V			20			60			2.7	20.77	21.46	22.21	23.01	-	○
SPM200-BN2-2-3-V	2	1	3	1.6	1.92	50	4	4	9.72	3.11	3.22	3.32	3.42	3.62	●
SPM200-BN2-2-4-V			4			50			8.32	4.16	4.31	4.44	4.57	4.86	●
SPM200-BN2-2-6-V			6			50			6.46	6.26	6.46	6.66	6.87	7.35	●
SPM200-BN2-2-8-V			8			50			5.27	8.34	8.6	8.88	9.17	9.84	●
SPM200-BN2-2-10-V			10			50			4.46	10.41	10.74	11.09	11.47	12.32	●
SPM200-BN2-2-12-V			12			55			3.86	12.48	12.88	13.31	13.77	14.81	●
SPM200-BN2-2-13-V			13			55			3.62	13.51	13.95	14.42	14.92	16.05	●
SPM200-BN2-2-14-V			14			55			3.4	14.55	15.02	15.53	16.07	17.29	●
SPM200-BN2-2-16-V			16			55			3.04	16.62	17.16	17.74	18.37	19.78	●

● Stock ○ Available upon Order

R	Tol
R ≤ 0.25	±0.003
R > 0.25	±0.005

(mm)

Recommended Cutting Data ※ P626

SPM200-BN2

2 Flutes with Extended Neck, Ballnose

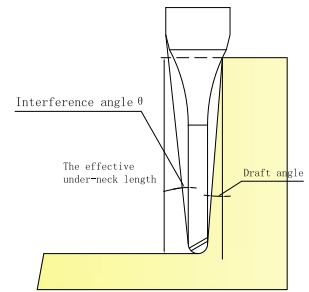
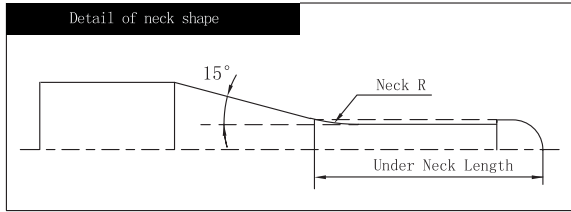

Please refer to page 167

» Continue

Ordering Code	Mill Dia. D	R	Under Neck Length L1	Flute Length Lc	Neck Dia. d2	Overall Length L	Shank Dia. d	Neck R	Interference Angle θ	The effective under-neck length for the various draft angles					Stock
										0.5°	1°	1.5°	2°	3°	
SPM200-BN2-2-18-V	2	1	18	1.6	1.92	60	4	4	2.75	18.68	19.3	19.96	20.67	-	○
SPM200-BN2-2-20-V			20			60			2.51	20.75	21.44	22.18	22.97	-	●
SPM200-BN2-2-22-V			22			60			2.31	22.82	23.58	24.39	25.27	-	○
SPM200-BN2-2-25-V			25			65			2.06	25.92	26.79	27.72	28.72	-	●
SPM200-BN2-2-30-V			30			70			1.75	31.09	32.14	33.26	-	-	○
SPM200-BN2-2-35-V			35			75			1.52	36.26	37.48	38.8	-	-	●
SPM200-BN2-2-40-V			40			80			1.34	41.42	42.83	-	-	-	○
SPM200-BN2-2.5-6-V	2.5	1.25	6	2	2.4	50	4	4	5.62	6.22	6.41	6.6	6.8	7.25	○
SPM200-BN2-2.5-10-V			10			50			3.69	10.37	10.69	11.03	11.4	12.23	●
SPM200-BN2-2.5-15-V			15			55			2.59	15.54	16.04	16.58	17.15	-	●
SPM200-BN2-2.5-20-V			20			60			1.99	20.71	21.39	22.12	-	-	○
SPM200-BN2-2.5-25-V			25			65			1.62	25.88	26.74	27.66	-	-	●
SPM200-BN2-2.5-30-V			30			70			1.36	31.05	32.09	-	-	-	●
SPM200-BN2-3-8-V	3	1.5	8	2.4	2.88	55	6	4	7.04	8.27	8.51	8.77	9.04	9.65	●
SPM200-BN2-3-10-V			10			55			6.05	10.34	10.65	10.98	11.34	12.14	●
SPM200-BN2-3-13-V			13			60			5	13.44	13.86	14.31	14.79	15.87	●
SPM200-BN2-3-16-V			16			60			4.26	16.55	17.07	17.63	18.24	19.6	●
SPM200-BN2-3-20-V			20			65			3.56	20.68	21.35	22.07	22.84	24.57	●
SPM200-BN2-3-25-V			25			70			2.95	25.85	26.7	27.61	28.59	-	●
SPM200-BN2-3-30-V			30			75			2.52	31.02	32.05	33.15	34.34	-	●
SPM200-BN2-3-35-V			35			80			2.2	36.19	37.39	38.69	40.08	-	●
SPM200-BN2-3.5-15-V			3.5			1.75			15	2.8	3.36	60	6	4	3.99
SPM200-BN2-3.5-25-V	25	70		2.56	25.82		26.66	27.56	28.53			-			○
SPM200-BN2-3.5-35-V	35	80		1.89	36.16		37.36	38.64	-			-			○

● Stock ○ Available upon Order

R	Tol
R ≤ 0.25	±0.003
R > 0.25	±0.005

(mm)

Recommended Cutting Data ※ P626

SPM200-BN2

2 Flutes with Extended Neck, Ballnose

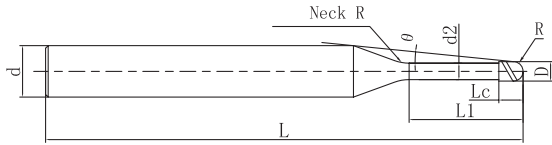

Please refer to page 167

» Continue

Ordering Code	Mill Dia. D	R	Under Neck Length L1	Flute Length Lc	Neck Dia. d2	Overall Length L	Shank Dia. d	Neck R	Interference Angle θ	The effective under-neck length for the various draft angles					Stock
										0.5°	1°	1.5°	2°	3°	
SPM200-BN2-3.5-45-V	3.5	1.75	45	2.8	3.36	90	6	4	1.5	46.5	48.05	-	-	-	○
SPM200-BN2-4-10-V	4	2	10	3.2	3.86	55	6	4	4.86	10.31	10.6	10.91	11.24	11.99	○
SPM200-BN2-4-13-V			13			60			3.88	13.41	13.81	14.23	14.69	15.72	●
SPM200-BN2-4-16-V			16			60			3.23	16.51	17.02	17.56	18.14	19.45	○
SPM200-BN2-4-20-V			20			65			2.63	20.65	21.3	21.99	22.74	-	●
SPM200-BN2-4-25-V			25			70			2.14	25.81	26.64	27.53	28.49	-	●
SPM200-BN2-4-30-V			30			75			1.81	30.98	31.99	33.08	-	-	○
SPM200-BN2-4-35-V			35			80			1.56	36.15	37.34	38.62	-	-	○
SPM200-BN2-4-40-V			40			80			1.38	41.32	42.69	-	-	-	●
SPM200-BN2-4-45-V			45			90			1.23	46.49	48.04	-	-	-	○
SPM200-BN2-4-50-V			50			100			1.11	51.66	53.39	-	-	-	●
SPM200-BN2-5-20-V	5	2.5	20	4	4.85	65	6	4	1.48	20.62	21.25	-	-	-	●
SPM200-BN2-5-25-V			25			70			1.18	25.79	26.6	-	-	-	○
SPM200-BN2-5-30-V			30			75			0.98	30.96	-	-	-	-	○
SPM200-BN2-5-40-V			40			80			0.73	41.29	-	-	-	-	○
SPM200-BN2-6-12-V	6	3	12	6	5.85	60	6	-	-	-	-	-	-	-	○
SPM200-BN2-6-20-V			20			65			-	-	-	-	-	○	
SPM200-BN2-6-30-V			30			75			-	-	-	-	-	●	
SPM200-BN2-6-50-V			50			100			-	-	-	-	-	○	

● Stock ○ Available upon Order

R	Tol
R ≤ 0.25	±0.003
R > 0.25	±0.005

(mm)

Recommended Cutting Data ※ P626



SHM200-SN2

2 Flutes with Extended Neck, Square

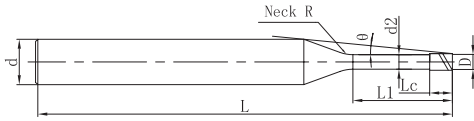

Please refer to page 167

Ordering Code	Mill Dia. D	Under Neck Length L1	Flute Length Lc	Neck Dia. d2	Overall Length L	Shank Dia. d	Neck R	Interference Angle θ	The effective under-neck length for the various draft angles					Stock
									0.5°	1°	1.5°	2°	3°	
SHM200-SN2-0.1-0.3-K	0.1	0.3	0.15	0.08	50	4	1	14.39	0.31	0.33	0.35	0.37	0.40	○
SHM200-SN2-0.1-0.5-K		0.5							0.52	0.55	0.58	0.60	0.65	○
SHM200-SN2-0.1-1-K		1							1.05	1.09	1.13	1.18	1.27	○
SHM200-SN2-0.2-0.5-K	0.2	0.5	0.3	0.17	50	4	1	14.03	0.52	0.54	0.57	0.59	0.64	●
SHM200-SN2-0.2-1-K		1							1.04	1.08	1.12	1.16	1.26	○
SHM200-SN2-0.2-1.5-K		1.5							1.56	1.62	1.67	1.74	1.88	○
SHM200-SN2-0.2-2-K	0.2	2	0.3	0.17	50	4	1	11.79	2.08	2.15	2.23	2.31	2.50	○
SHM200-SN2-0.2-3-K		3							3.11	3.22	3.34	3.46	3.74	○
SHM200-SN2-0.3-1-K		1							1.06	1.12	1.18	1.23	1.33	●
SHM200-SN2-0.3-1.5-K	0.3	1.5	0.45	0.27	50	4	2	12.31	1.59	1.67	1.74	1.81	1.95	○
SHM200-SN2-0.3-2-K		2							2.12	2.21	2.29	2.38	2.57	○
SHM200-SN2-0.3-2.5-K		2.5							2.64	2.75	2.85	2.96	3.20	●
SHM200-SN2-0.3-3-K	0.3	3	0.45	0.27	50	4	2	10.51	3.16	3.28	3.40	3.53	3.82	○
SHM200-SN2-0.4-1-K		1							1.06	1.12	1.18	1.23	1.33	●
SHM200-SN2-0.4-1.5-K		1.5							1.59	1.67	1.74	1.81	1.95	●
SHM200-SN2-0.4-2-K	0.4	2	0.6	0.37	50	4	2	11.57	2.12	2.21	2.29	2.38	2.57	●
SHM200-SN2-0.4-2.5-K		2.5							2.64	2.75	2.85	2.96	3.20	○
SHM200-SN2-0.4-3-K		3							3.16	3.28	3.40	3.53	3.82	○
SHM200-SN2-0.4-3.5-K	0.4	3.5	0.6	0.37	50	4	2	9.92	3.68	3.82	3.96	4.11	4.44	●
SHM200-SN2-0.4-4-K		4							4.20	4.35	4.51	4.68	5.06	○
SHM200-SN2-0.4-5-K		5							5.24	5.42	5.62	5.83	6.30	○
SHM200-SN2-0.4-6-K	0.4	6	0.6	0.37	50	4	2	8.01	6.27	6.49	6.73	6.98	7.55	○
SHM200-SN2-0.4-8-K		8							8.34	8.63	8.94	9.28	10.03	○
SHM200-SN2-0.4-10-K		10							10.41	10.77	11.16	11.58	12.52	○

● Stock ○ Available upon Order

D	Tol
0.1 ≤ D ≤ 1.0	0 -0.007
1.0 < D ≤ 6.0	0 -0.01

Unit (mm)

Recommended Cutting Data ※ P589

SHM200-SN2

2 Flutes with Extended Neck, Square

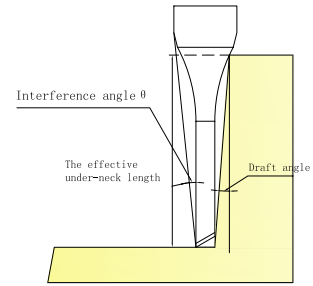
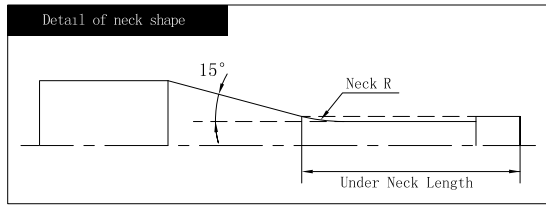

Please refer to page 167

» Continue

Ordering Code	Mill Dia. D	Under Neck Length L1	Flute Length Lc	Neck Dia. d2	Overall Length L	Shank Dia. d	Neck R	Interference Angle θ	The effective under-neck length for the various draft angles					Stock	
									0.5°	1°	1.5°	2°	3°		
SHM200-SN2-0.5-1-K	0.5	1	0.75	0.47	50	4	2	12.96	1.06	1.12	1.18	1.23	1.33	○	
SHM200-SN2-0.5-1.5-K		1.5							1.59	1.67	1.74	1.81	1.95	●	
SHM200-SN2-0.5-2-K		2							11.50	2.12	2.21	2.29	2.38	2.57	○
SHM200-SN2-0.5-2.5-K		2.5							10.88	2.64	2.75	2.85	2.96	3.20	○
SHM200-SN2-0.5-3-K		3							10.33	3.16	3.28	3.40	3.53	3.82	●
SHM200-SN2-0.5-4-K		4							9.37	4.20	4.35	4.51	4.68	5.06	●
SHM200-SN2-0.5-5-K		5							8.58	5.24	5.42	5.62	5.83	6.30	○
SHM200-SN2-0.5-6-K		6							7.91	6.27	6.49	6.73	6.98	7.55	●
SHM200-SN2-0.5-8-K		8							6.84	8.34	8.63	8.94	9.28	10.03	○
SHM200-SN2-0.5-10-K		10							6.02	10.41	10.77	11.16	11.58	12.52	○
SHM200-SN2-0.6-2-K	0.6	2	0.9	0.57	50	4	4	11.21	2.17	2.31	2.44	2.56	2.78	○	
SHM200-SN2-0.6-3-K		3							10.07	3.24	3.42	3.58	3.72	4.02	●
SHM200-SN2-0.6-4-K		4							9.13	4.30	4.51	4.69	4.87	5.26	●
SHM200-SN2-0.6-5-K		5							8.36	5.35	5.59	5.80	6.02	6.50	○
SHM200-SN2-0.6-6-K		6							14.39	0.31	0.33	0.35	0.37	0.40	○
SHM200-SN2-0.6-7-K		7							14.03	0.52	0.55	0.58	0.60	0.65	○
SHM200-SN2-0.6-8-K		8							13.22	1.05	1.09	1.13	1.18	1.27	○
SHM200-SN2-0.6-9-K		9							14.03	0.52	0.54	0.57	0.59	0.64	○
SHM200-SN2-0.6-10-K		10							13.20	1.04	1.08	1.12	1.16	1.26	○
SHM200-SN2-0.7-2-K		0.7							2	1.05	0.67	50	4	4	12.45
SHM200-SN2-0.7-4-K	4		11.79	2.08	2.15	2.23	2.31	2.50	○						
SHM200-SN2-0.7-6-K	6		10.65	3.11	3.22	3.34	3.46	3.74	○						
SHM200-SN2-0.7-8-K	8		13.06	1.06	1.12	1.18	1.23	1.33	○						
SHM200-SN2-0.7-10-K	10		12.31	1.59	1.67	1.74	1.81	1.95	○						

● Stock ○ Available upon Order

D	Tol
0.1 ≤ D ≤ 1.0	0 -0.007
1.0 < D ≤ 6.0	0 -0.01

Unit (mm)

Recommended Cutting Data ※ P589

SHM200-SN2

2 Flutes with Extended Neck, Square

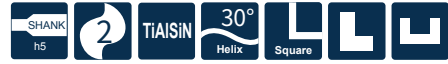
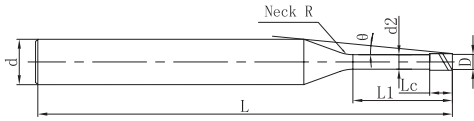

Please refer to page 167

» Continue

Ordering Code	Mill Dia. D	Under Neck Length L1	Flute Length Lc	Neck Dia. d2	Overall Length L	Shank Dia. d	Neck R	Interference Angle θ	The effective under-neck length for the various draft angles					Stock	
									0.5°	1°	1.5°	2°	3°		
SHM200-SN2-0.8-4-K	0.8	4	1.2	0.76	50	4	4	11.65	2.12	2.21	2.29	2.38	2.57	●	
SHM200-SN2-0.8-6-K		6			50				11.05	2.64	2.75	2.85	2.96	3.20	●
SHM200-SN2-0.8-8-K		8			50				10.51	3.16	3.28	3.40	3.53	3.82	○
SHM200-SN2-0.8-10-K		10			50				13.01	1.06	1.12	1.18	1.23	1.33	○
SHM200-SN2-0.8-12-K		12			55				12.25	1.59	1.67	1.74	1.81	1.95	○
SHM200-SN2-0.9-6-K	0.9	6	1.35	0.86	50	4	4	11.57	2.12	2.21	2.29	2.38	2.57	●	
SHM200-SN2-0.9-8-K		8			50				10.97	2.64	2.75	2.85	2.96	3.20	○
SHM200-SN2-0.9-10-K		10			50				10.42	3.16	3.28	3.40	3.53	3.82	○
SHM200-SN2-0.9-12-K		12			55				9.92	3.68	3.82	3.96	4.11	4.44	○
SHM200-SN2-1-2-K	1	2	1.5	0.96	50	4	4	9.47	4.20	4.35	4.51	4.68	5.06	○	
SHM200-SN2-1-3-K		3			50				8.68	5.24	5.42	5.62	5.83	6.30	●
SHM200-SN2-1-4-K		4			50				8.01	6.27	6.49	6.73	6.98	7.55	●
SHM200-SN2-1-5-K		5			50				6.94	8.34	8.63	8.94	9.28	10.03	●
SHM200-SN2-1-6-K		6			50				6.12	10.41	10.77	11.16	11.58	12.52	●
SHM200-SN2-1-7-K		7			50				12.96	1.06	1.12	1.18	1.23	1.33	●
SHM200-SN2-1-8-K		8			50				12.19	1.59	1.67	1.74	1.81	1.95	●
SHM200-SN2-1-9-K		9			50				11.50	2.12	2.21	2.29	2.38	2.57	○
SHM200-SN2-1-10-K		10			50				10.88	2.64	2.75	2.85	2.96	3.20	●
SHM200-SN2-1-12-K		12			55				10.33	3.16	3.28	3.40	3.53	3.82	○
SHM200-SN2-1-14-K		14			55				9.37	4.20	4.35	4.51	4.68	5.06	○
SHM200-SN2-1-16-K		16			55				8.58	5.24	5.42	5.62	5.83	6.30	●
SHM200-SN2-1-20-K		20			60				7.91	6.27	6.49	6.73	6.98	7.55	○
SHM200-SN2-1-25-K		25			65					8.34	8.63	8.94	9.28	10.03	○
SHM200-SN2-1.2-6-K		1.2			6				1.8	1.15	50	4	4	14.39	0.31

● Stock ○ Available upon Order

D	Tol
0.1 ≤ D ≤ 1.0	0 -0.007
1.0 < D ≤ 6.0	0 -0.01

Unit (mm)

Recommended Cutting Data ※ P589

SHM200-SN2

2 Flutes with Extended Neck, Square

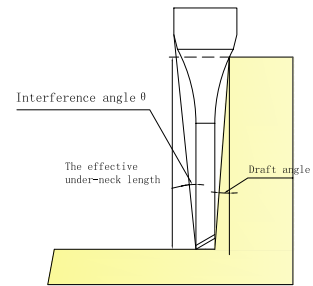
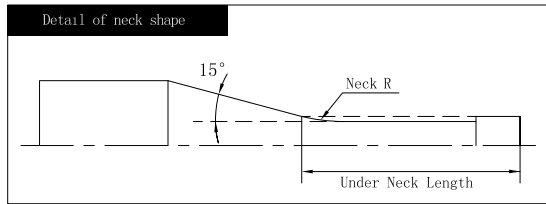

Please refer to page 167

» Continue

Ordering Code	Mill Dia. D	Under Neck Length L1	Flute Length Lc	Neck Dia. d2	Overall Length L	Shank Dia. d	Neck R	Interference Angle θ	The effective under-neck length for the various draft angles					Stock
									0.5°	1°	1.5°	2°	3°	
SHM200-SN2-1.2-8-K	1.2	8	1.8	1.15	50	4	4	14.03	0.52	0.55	0.58	0.60	0.65	○
SHM200-SN2-1.2-10-K		10			13.22			1.05	1.09	1.13	1.18	1.27	○	
SHM200-SN2-1.2-12-K		12			14.03			0.52	0.54	0.57	0.59	0.64	○	
SHM200-SN2-1.2-16-K		16			13.20			1.04	1.08	1.12	1.16	1.26	○	
SHM200-SN2-1.4-6-K	1.4	6	2.1	1.34	50	4	4	12.45	1.56	1.62	1.67	1.74	1.88	●
SHM200-SN2-1.4-12-K		12			11.79			2.08	2.15	2.23	2.31	2.50	○	
SHM200-SN2-1.5-4-K	1.5	4	2.25	1.44	50	4	4	10.65	3.11	3.22	3.34	3.46	3.74	○
SHM200-SN2-1.5-6-K		6			13.06			1.06	1.12	1.18	1.23	1.33	●	
SHM200-SN2-1.5-8-K		8			12.31			1.59	1.67	1.74	1.81	1.95	●	
SHM200-SN2-1.5-10-K		10			11.65			2.12	2.21	2.29	2.38	2.57	○	
SHM200-SN2-1.5-12-K		12			11.05			2.64	2.75	2.85	2.96	3.20	○	
SHM200-SN2-1.5-14-K		14			10.51			3.16	3.28	3.40	3.53	3.82	○	
SHM200-SN2-1.5-16-K		16			13.01			1.06	1.12	1.18	1.23	1.33	○	
SHM200-SN2-1.5-18-K		15			4			4	1.67	1.74	1.81	1.95	○	
SHM200-SN2-1.5-20-K		20			11.57			2.12	2.21	2.29	2.38	2.57	○	
SHM200-SN2-1.5-25-K		25			10.97			2.64	2.75	2.85	2.96	3.20	○	
SHM200-SN2-1.5-30-K		30			10.42			3.16	3.28	3.40	3.53	3.82	○	
SHM200-SN2-1.5-35-K		35			9.92			3.68	3.82	3.96	4.11	4.44	○	
SHM200-SN2-1.5-40-K		40			9.47			4.20	4.35	4.51	4.68	5.06	○	
SHM200-SN2-1.6-6-K		1.6			6			2.4	1.54	50	4	4	8.68	5.24
SHM200-SN2-1.6-8-K	8		8.01	6.27	6.49	6.73	6.98			7.55			○	
SHM200-SN2-1.8-6-K	1.8	6	2.7	1.73	50	4	4	6.94	8.34	8.63	8.94	9.28	10.03	○
SHM200-SN2-1.8-8-K		8			6.12			10.41	10.77	11.16	11.58	12.52	○	
SHM200-SN2-2-4-K	2	4	3	1.92	50	4	4	12.96	1.06	1.12	1.18	1.23	1.33	○

● Stock ○ Available upon Order

D	Tol
0.1 ≤ D ≤ 1.0	0 -0.007
1.0 < D ≤ 6.0	0 -0.01

Unit (mm)

Recommended Cutting Data ※ P589

SHM200-SN2

2 Flutes with Extended Neck, Square

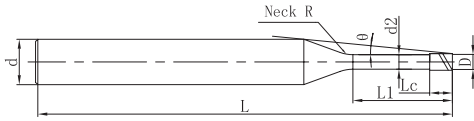

Please refer to page 167

» Continue

Ordering Code	Mill Dia. D	Under Neck Length L1	Flute Length Lc	Neck Dia. d2	Overall Length L	Shank Dia. d	Neck R	Interference Angle θ	The effective under-neck length for the various draft angles					Stock
									0.5°	1°	1.5°	2°	3°	
SHM200-SN2-2-6-K	2	6	3	1.92	50	4	4	12.19	1.59	1.67	1.74	1.81	1.95	○
SHM200-SN2-2-8-K		8			11.50				2.12	2.21	2.29	2.38	2.57	●
SHM200-SN2-2-10-K		10			10.88				2.64	2.75	2.85	2.96	3.20	●
SHM200-SN2-2-12-K		12			10.33				3.16	3.28	3.40	3.53	3.82	●
SHM200-SN2-2-14-K		14			9.37				4.20	4.35	4.51	4.68	5.06	●
SHM200-SN2-2-16-K		16			8.58				5.24	5.42	5.62	5.83	6.30	●
SHM200-SN2-2-18-K		18			7.91				6.27	6.49	6.73	6.98	7.55	○
SHM200-SN2-2-20-K		20			6.84				8.34	8.63	8.94	9.28	10.03	○
SHM200-SN2-2-25-K		25			6.02				10.41	10.77	11.16	11.58	12.52	○
SHM200-SN2-2-30-K		30			11.21				2.17	2.31	2.44	2.56	2.78	○
SHM200-SN2-2-35-K		35			10.07				3.24	3.42	3.58	3.72	4.02	○
SHM200-SN2-2-40-K		40			9.13				4.30	4.51	4.69	4.87	5.26	○
SHM200-SN2-2-50-K		50			8.36				5.35	5.59	5.80	6.02	6.50	○
SHM200-SN2-2.5-8-K	2.5	8	3.75	2.4	50	4	4	14.39	0.31	0.33	0.35	0.37	0.40	○
SHM200-SN2-2.5-12-K		12			14.03				0.52	0.55	0.58	0.60	0.65	○
SHM200-SN2-2.5-16-K		16			13.22				1.05	1.09	1.13	1.18	1.27	○
SHM200-SN2-2.5-20-K		20			14.03				0.52	0.54	0.57	0.59	0.64	○
SHM200-SN2-2.5-30-K		30			13.20				1.04	1.08	1.12	1.16	1.26	○
SHM200-SN2-2.5-40-K		40			12.45				1.56	1.62	1.67	1.74	1.88	○
SHM200-SN2-2.5-50-K		50			11.79				2.08	2.15	2.23	2.31	2.50	○
SHM200-SN2-3-8-K	3	8	4.5	2.88	55	6	4	10.65	3.11	3.22	3.34	3.46	3.74	○
SHM200-SN2-3-12-K		12			13.06				1.06	1.12	1.18	1.23	1.33	○
SHM200-SN2-3-16-K		16			12.31				1.59	1.67	1.74	1.81	1.95	●
SHM200-SN2-3-20-K		20			11.65				2.12	2.21	2.29	2.38	2.57	○

● Stock ○ Available upon Order

D	Tol
0.1 ≤ D ≤ 1.0	0 -0.007
1.0 < D ≤ 6.0	0 -0.01

Unit (mm)

Recommended Cutting Data ※ P589

SHM200-SN2

2 Flutes with Extended Neck, Square

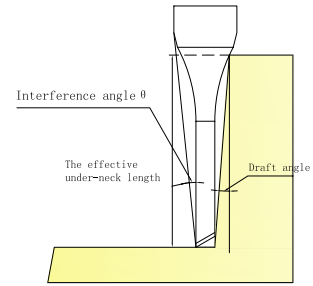
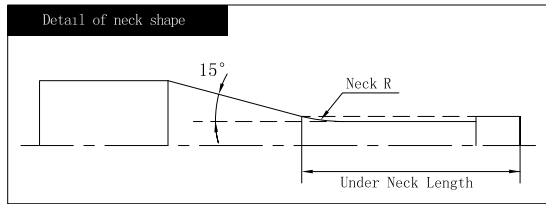

Please refer to page 167

» Continue

Ordering Code	Mill Dia. D	Under Neck Length L1	Flute Length Lc	Neck Dia. d2	Overall Length L	Shank Dia. d	Neck R	Interference Angle θ	The effective under-neck length for the various draft angles					Stock	
									0.5°	1°	1.5°	2°	3°		
SHM200-SN2-3-25-K	3	25	4.5	2.88	70	6	4	11.05	2.64	2.75	2.85	2.96	3.20	○	
SHM200-SN2-3-30-K		30			75				10.51	3.16	3.28	3.40	3.53	3.82	○
SHM200-SN2-3-40-K		40			90				13.01	1.06	1.12	1.18	1.23	1.33	○
SHM200-SN2-3-50-K		50			100				4	4	1.67	1.74	1.81	1.95	○
SHM200-SN2-4-12-K	4	12	6	3.86	60	6	4	11.57	2.12	2.21	2.29	2.38	2.57	○	
SHM200-SN2-4-16-K		16			60				10.97	2.64	2.75	2.85	2.96	3.20	○
SHM200-SN2-4-20-K		20			70				10.42	3.16	3.28	3.40	3.53	3.82	●
SHM200-SN2-4-25-K		25			70				9.92	3.68	3.82	3.96	4.11	4.44	●
SHM200-SN2-4-30-K		30			80				9.47	4.20	4.35	4.51	4.68	5.06	○
SHM200-SN2-4-35-K		35			80				8.68	5.24	5.42	5.62	5.83	6.30	○
SHM200-SN2-4-40-K		40			90				8.01	6.27	6.49	6.73	6.98	7.55	○
SHM200-SN2-4-50-K		50			100				6.94	8.34	8.63	8.94	9.28	10.03	○
SHM200-SN2-5-20-K	5	20	7.5	4.85	70	6	4	6.12	10.41	10.77	11.16	11.58	12.52	○	
SHM200-SN2-5-25-K		25			70				12.96	1.06	1.12	1.18	1.23	1.33	○
SHM200-SN2-5-30-K		30			80				12.19	1.59	1.67	1.74	1.81	1.95	○
SHM200-SN2-5-40-K		40			90				11.50	2.12	2.21	2.29	2.38	2.57	○
SHM200-SN2-5-50-K		50			100				10.88	2.64	2.75	2.85	2.96	3.20	○
SHM200-SN2-6-20-K	6	20	9	5.85	70	6	-	10.33	3.16	3.28	3.40	3.53	3.82	○	
SHM200-SN2-6-30-K		30			80				9.37	4.20	4.35	4.51	4.68	5.06	○
SHM200-SN2-6-40-K		40			90				8.58	5.24	5.42	5.62	5.83	6.30	○
SHM200-SN2-6-50-K		50			100				7.91	6.27	6.49	6.73	6.98	7.55	○

● Stock ○ Available upon Order

D	Tol
0.1 ≤ D ≤ 1.0	0 -0.007
1.0 < D ≤ 6.0	0 -0.01

Unit (mm)

Recommended Cutting Data ※ P589

SHM200-RN2

2 Flutes with Extended Neck, Corner Radius

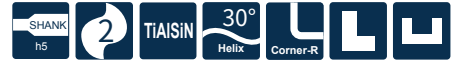
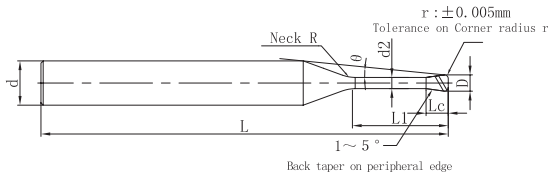

Please refer to page 167

Ordering Code	Mill Dia. D	R	Under Neck Length L1	Flute Length Lc	Neck Dia. d2	Overall Length L	Shank Dia. d	Neck R	Interference Angle θ	The effective under-neck length for the various draft angles					Stock								
										0.5°	1°	1.5°	2°	3°									
SHM200-RN2-0.2-0.5-0.02-K	0.2	0.02	0.5	0.16	0.17	50	4	1	14.07	0.52	0.54	0.56	0.58	0.63	○								
SHM200-RN2-0.2-1-0.02-K			1							1.04	1.08	1.12	1.16	1.25	○								
SHM200-RN2-0.2-2-0.02-K			2							2.08	2.15	2.23	2.31	2.50	○								
SHM200-RN2-0.2-0.5-0.05-K		0.05	0.5							0.24	0.27	50	4	2	13.09	0.52	0.54	0.56	0.58	0.62	○		
SHM200-RN2-0.2-1-0.05-K			1													1.04	1.08	1.11	1.15	1.24	○		
SHM200-RN2-0.2-1.5-0.05-K			1.5													1.56	1.61	1.67	1.73	1.87	○		
SHM200-RN2-0.2-2-0.05-K			2													2.08	2.15	2.22	2.30	2.49	○		
SHM200-RN2-0.3-1-0.02-K	0.3	0.02	1	0.32	0.37	50	4	2	13.04							1.06	1.12	1.17	1.23	1.33	○		
SHM200-RN2-0.3-2-0.02-K			2													2.11	2.21	2.29	2.38	2.57	○		
SHM200-RN2-0.3-3-0.02-K			3													3.16	3.28	3.40	3.53	3.81	○		
SHM200-RN2-0.3-1-0.05-K		0.05	1							10.53	3.16	3.28	3.40	3.53	3.81	10.44	1.06	1.12	1.17	1.22	1.32	○	
SHM200-RN2-0.3-1.5-0.05-K			1.5														1.59	1.66	1.73	1.80	1.94	○	
SHM200-RN2-0.3-2-0.05-K			2														2.11	2.21	2.29	2.37	2.56	○	
SHM200-RN2-0.3-2.5-0.05-K			2.5														2.64	2.75	2.84	2.95	3.18	○	
SHM200-RN2-0.3-3-0.05-K	3	3.16	3.28	3.40	3.52	3.81	○																
SHM200-RN2-0.4-1-0.02-K	0.4	0.02	1	10.47	3.16	3.28	3.40	3.52	3.81								11.03	1.06	1.12	1.17	1.22	1.32	○
SHM200-RN2-0.4-2-0.02-K			2															2.11	2.21	2.29	2.38	2.57	○
SHM200-RN2-0.4-3-0.02-K			3							3.16	3.28	3.40	3.53	3.81	○								
SHM200-RN2-0.4-4-0.02-K			4							4.20	4.35	4.51	4.68	5.06	○								
SHM200-RN2-0.4-1-0.05-K		0.05	1							11.60	2.11	2.21	2.29	2.37	2.56	11.64		1.06	1.12	1.17	1.22	1.32	○
SHM200-RN2-0.4-1.5-0.05-K			1.5															1.59	1.66	1.73	1.80	1.94	○
SHM200-RN2-0.4-2-0.05-K			2															2.11	2.21	2.29	2.37	2.56	○
SHM200-RN2-0.4-2.5-0.05-K	2.5	2.64	2.75	2.84	2.95	3.18	○																
SHM200-RN2-0.4-3-0.05-K	3	3.16	3.28	3.40	3.52	3.81	○																

● Stock ○ Available upon Order

R	Tol
R	±0.005

Unit(mm)

Recommended Cutting Data ※ P599

SHM200-RN2

2 Flutes with Extended Neck, Corner Radius

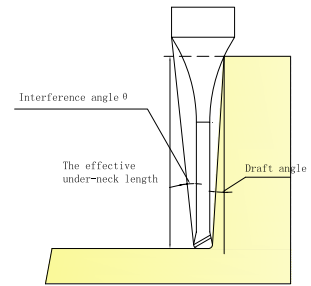
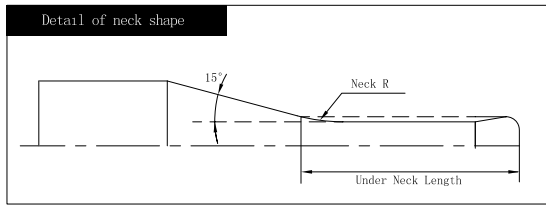

Please refer to page 167

» Continue

Ordering Code	Mill Dia. D	R	Under Neck Length L1	Flute Length Lc	Neck Dia. d2	Overall Length L	Shank Dia. d	Neck R	Interference Angle θ	The effective under-neck length for the various draft angles					Stock	
										0.5°	1°	1.5°	2°	3°		
SHM200-RN2-0.4-3.5-0.05-K	0.4	0.05	3.5	0.32	0.37	50	4	2	9.97	3.68	3.82	3.95	4.10	4.43	○	
SHM200-RN2-0.4-4-0.05-K			4							4.20	4.35	4.51	4.67	5.05	○	
SHM200-RN2-0.4-1-0.1-K		0.1	1							1.06	1.11	1.16	1.21	1.31	○	
SHM200-RN2-0.4-2-0.1-K			2							11.70	2.11	2.20	2.28	2.37	2.55	○
SHM200-RN2-0.4-3-0.1-K			3							10.53	3.16	3.28	3.39	3.52	3.79	○
SHM200-RN2-0.4-4-0.1-K			4							9.56	4.20	4.35	4.50	4.67	5.04	○
SHM200-RN2-0.5-1-0.02-K	0.5	0.02	1	0.4	0.47	50	4	2	13.00	1.06	1.12	1.17	1.23	1.33	○	
SHM200-RN2-0.5-2-0.02-K			2							11.53	2.11	2.21	2.29	2.38	2.57	○
SHM200-RN2-0.5-3-0.02-K			3							10.35	3.16	3.28	3.40	3.53	3.81	○
SHM200-RN2-0.5-4-0.02-K		4	9.39							4.20	4.35	4.51	4.68	5.06	○	
SHM200-RN2-0.5-6-0.02-K		6	7.92							6.27	6.49	6.73	6.98	7.54	○	
SHM200-RN2-0.5-1-0.05-K		0.05	1							13.05	1.06	1.12	1.17	1.22	1.32	○
SHM200-RN2-0.5-2-0.05-K	2		11.56	2.11	2.21	2.29	2.37	2.56	○							
SHM200-RN2-0.5-3-0.05-K	3		10.38	3.16	3.28	3.40	3.52	3.81	○							
SHM200-RN2-0.5-4-0.05-K	0.5	0.5	4	0.4	0.47	50	4	2	9.42	4.20	4.35	4.51	4.67	5.05	○	
SHM200-RN2-0.5-5-0.05-K			5							8.62	5.24	5.42	5.61	5.82	6.29	○
SHM200-RN2-0.5-6-0.05-K			6							7.94	6.27	6.49	6.72	6.97	7.53	○
SHM200-RN2-0.5-1-0.1-K		0.1	1							13.13	1.06	1.11	1.16	1.21	1.31	○
SHM200-RN2-0.5-2-0.1-K			2							11.63	2.11	2.20	2.28	2.37	2.55	●
SHM200-RN2-0.5-3-0.1-K			3							10.44	3.16	3.28	3.39	3.52	3.79	○
SHM200-RN2-0.5-4-0.1-K	4		9.46	4.20	4.35	4.50	4.67	5.04	○							
SHM200-RN2-0.5-5-0.1-K	5	8.65	5.24	5.42	5.61	5.82	6.28	○								
SHM200-RN2-0.5-6-0.1-K	6	7.97	6.27	6.49	6.72	6.97	7.52	○								
SHM200-RN2-0.6-2-0.02-K	0.6	0.02	2	0.48	0.57	50	4	4	11.24	2.17	2.31	2.44	2.55	2.77	○	

● Stock ○ Available upon Order

R	Tol
R	±0.005

Unit(mm)

Recommended Cutting Data ※ P599

SHM200-RN2

2 Flutes with Extended Neck, Corner Radius

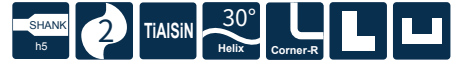
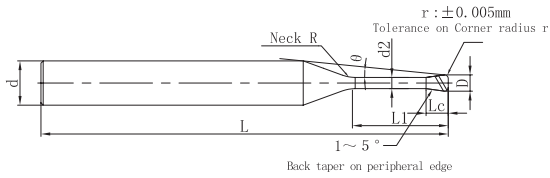

Please refer to page 167

» Continue

Ordering Code	Mill Dia. D	R	Under Neck Length L1	Flute Length Lc	Neck Dia. d2	Overall Length L	Shank Dia. d	Neck R	Interference Angle θ	The effective under-neck length for the various draft angles					Stock	
										0.5°	1°	1.5°	2°	3°		
SHM200-RN2-0.6-4-0.02-K	0.6	0.02	4	0.48	0.57	50	4	4	9.15	4.29	4.51	4.69	4.86	5.26	○	
SHM200-RN2-0.6-6-0.02-K			6							7.71	6.40	6.66	6.90	7.16	7.74	○
SHM200-RN2-0.6-2-0.05-K		0.05	2							11.27	2.17	2.31	2.43	2.55	2.76	○
SHM200-RN2-0.6-4-0.05-K			4							9.18	4.29	4.51	4.68	4.86	5.25	●
SHM200-RN2-0.6-6-0.05-K		6	7.73							6.40	6.66	6.90	7.16	7.74	○	
SHM200-RN2-0.6-8-0.05-K		8	6.68							8.49	8.80	9.12	9.46	10.22	○	
SHM200-RN2-0.6-10-0.05-K		10	5.88							10.57	10.94	11.33	11.76	12.71	○	
SHM200-RN2-0.6-2-0.1-K		0.1	2							11.34	2.16	2.30	2.43	2.54	2.75	○
SHM200-RN2-0.6-4-0.1-K			4							9.22	4.29	4.50	4.68	4.85	5.24	○
SHM200-RN2-0.6-6-0.1-K			6							7.76	6.39	6.66	6.90	7.15	7.72	○
SHM200-RN2-0.6-8-0.1-K			8							6.70	8.48	8.80	9.11	9.45	10.21	○
SHM200-RN2-0.6-10-0.1-K			10							5.89	10.57	10.94	11.33	11.75	12.70	○
SHM200-RN2-0.7-4-0.05-K	0.7	0.05	4	0.56	0.67	50	4	4	9.07	4.29	4.51	4.68	4.86	5.25	○	
SHM200-RN2-0.7-6-0.05-K			6							7.62	6.40	6.66	6.90	7.16	7.74	○
SHM200-RN2-0.7-4-0.1-K		0.1	4							9.11	4.29	4.50	4.68	4.85	5.24	○
SHM200-RN2-0.7-6-0.1-K			6							7.65	6.39	6.66	6.90	7.15	7.72	○
SHM200-RN2-0.8-4-0.02-K	0.8	0.02	4	0.64	0.76	50	4	4	8.96	4.27	4.47	4.65	4.82	5.21	○	
SHM200-RN2-0.8-6-0.02-K			6							7.51	6.37	6.63	6.87	7.12	7.70	○
SHM200-RN2-0.8-4-0.05-K		0.05	4							8.99	4.27	4.47	4.65	4.82	5.21	○
SHM200-RN2-0.8-6-0.05-K			6							7.52	6.37	6.63	6.86	7.12	7.69	○
SHM200-RN2-0.8-8-0.05-K		8	6.47							8.45	8.76	9.08	9.42	10.18	○	
SHM200-RN2-0.8-12-0.05-K		12	5.05							12.61	13.04	13.51	14.02	15.15	○	
SHM200-RN2-0.8-4-0.1-K		0.1	4							9.03	4.26	4.47	4.64	4.81	5.19	○
SHM200-RN2-0.8-6-0.1-K			6							7.55	6.37	6.62	6.86	7.11	7.68	○

● Stock ○ Available upon Order

R	Tol
R	±0.005

Unit(mm)

Recommended Cutting Data ※ P599

SHM200-RN2

2 Flutes with Extended Neck, Corner Radius

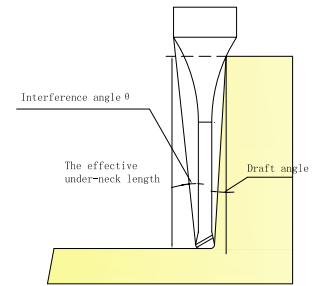
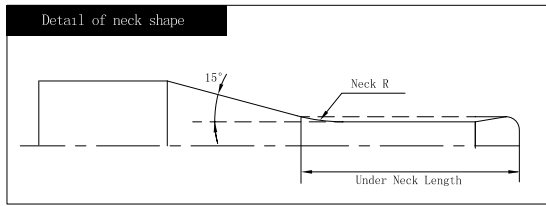

Please refer to page 167

» Continue

Ordering Code	Mill Dia. D	R	Under Neck Length L1	Flute Length Lc	Neck Dia. d2	Overall Length L	Shank Dia. d	Neck R	Interference Angle θ	The effective under-neck length for the various draft angles					Stock		
										0.5°	1°	1.5°	2°	3°			
SHM200-RN2-0.8-8-0.1-K	0.8	0.1	8	0.64	0.76	50	4	4	6.49	8.45	8.76	9.07	9.41	10.17	○		
SHM200-RN2-0.8-12-0.1-K			12			55				5.06	12.60	13.04	13.51	14.01	15.14	○	
SHM200-RN2-0.8-4-0.2-K		0.2	4			50				9.12	4.26	4.46	4.63	4.80	5.17	●	
SHM200-RN2-0.8-6-0.2-K			6			50				7.62	6.36	6.61	6.85	7.10	7.66	○	
SHM200-RN2-0.8-8-0.2-K			8			50				6.54	8.45	8.75	9.06	9.40	10.14	○	
SHM200-RN2-0.8-12-0.2-K			12			50				5.09	12.60	13.03	13.50	14.00	15.11	○	
SHM200-RN2-1-2-0.02-K	1	0.02	2	0.8	0.96	50	4	4	10.92	2.15	2.28	2.40	2.52	2.73	○		
SHM200-RN2-1-4-0.02-K			4			50				8.72	4.27	4.47	4.65	4.82	5.21	○	
SHM200-RN2-1-6-0.02-K			6			50				7.26	6.37	6.63	6.87	7.12	7.70	○	
SHM200-RN2-1-8-0.02-K			8			50				6.22	8.46	8.77	9.08	9.42	10.19	○	
SHM200-RN2-1-10-0.02-K			10			50				5.44	10.53	10.91	11.30	11.72	12.67	○	
SHM200-RN2-1-12-0.02-K			12			55				4.83	12.61	13.05	13.52	14.02	15.16	○	
SHM200-RN2-1-2-0.05-K		0.05	2			50				10.96	2.15	2.28	2.40	2.51	2.72	○	
SHM200-RN2-1-3-0.05-K			3			50				9.73	3.21	3.38	3.53	3.67	3.96	○	
SHM200-RN2-1-4-0.05-K			4			50				8.75	4.27	4.47	4.65	4.82	5.21	○	
SHM200-RN2-1-5-0.05-K			5			50				7.95	5.32	5.55	5.75	5.97	6.45	●	
SHM200-RN2-1-6-0.05-K			6			50				7.28	6.37	6.63	6.86	7.12	7.69	●	
SHM200-RN2-1-8-0.05-K			8			50				6.23	8.45	8.76	9.08	9.42	10.18	○	
SHM200-RN2-1-10-0.05-K			10			50				5.45	10.53	10.90	11.30	11.72	12.67	○	
SHM200-RN2-1-12-0.05-K			12			55				4.84	12.61	13.04	13.51	14.02	15.15	○	
SHM200-RN2-1-16-0.05-K			16			60				3.95	16.74	17.32	17.95	18.62	20.12	○	
SHM200-RN2-1-20-0.05-K			20			60				3.34	20.88	21.60	22.38	23.22	25.10	○	
SHM200-RN2-1-2-0.1-K			0.1			2				50	11.03	2.14	2.27	2.39	2.50	2.71	○
SHM200-RN2-1-3-0.1-K						3				50	9.79	3.21	3.38	3.53	3.66	3.95	○

● Stock ○ Available upon Order

R	Tol
R	±0.005

Unit(mm)

Recommended Cutting Data ※ P599

SHM200-RN2

2 Flutes with Extended Neck, Corner Radius

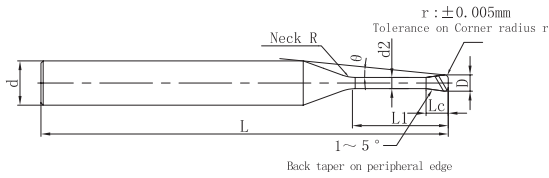

Please refer to page 167

» Continue

Ordering Code	Mill Dia. D	R	Under Neck Length L1	Flute Length Lc	Neck Dia. d2	Overall Length L	Shank Dia. d	Neck R	Interference Angle θ	The effective under-neck length for the various draft angles					Stock					
										0.5°	1°	1.5°	2°	3°						
SHM200-RN2-1-4-0.1-K	1	0.1	4	0.8	0.96	50	4	4	8.80	4.26	4.47	4.64	4.81	5.19	○					
SHM200-RN2-1-5-0.1-K			5			50			7.99	5.32	5.55	5.75	5.96	6.44	●					
SHM200-RN2-1-6-0.1-K			6			50			7.31	6.37	6.62	6.86	7.11	7.68	○					
SHM200-RN2-1-8-0.1-K			8			50			6.25	8.45	8.76	9.07	9.41	10.17	○					
SHM200-RN2-1-10-0.1-K			10			50			5.46	10.53	10.90	11.29	11.71	12.65	○					
SHM200-RN2-1-12-0.1-K			12			55			4.85	12.60	13.04	13.51	14.01	15.14	○					
SHM200-RN2-1-16-0.1-K			16			60			3.96	16.74	17.32	17.94	18.61	20.11	○					
SHM200-RN2-1-20-0.1-K			20			60			3.35	20.87	21.60	22.37	23.21	25.08	○					
SHM200-RN2-1-2-0.2-K			0.2			2			0.8	0.96	50	4	4	11.17	2.14	2.26	2.38	2.48	2.68	○
SHM200-RN2-1-3-0.2-K						3					50			9.90	3.20	3.37	3.51	3.65	3.93	○
SHM200-RN2-1-4-0.2-K		4		50	8.89	4.26	4.46	4.63			4.80			5.17	●					
SHM200-RN2-1-5-0.2-K		5		50	8.06	5.31	5.54	5.74			5.95			6.41	○					
SHM200-RN2-1-6-0.2-K		6		50	7.37	6.36	6.61	6.85			7.10			7.66	○					
SHM200-RN2-1-8-0.2-K		8		50	6.30	8.45	8.75	9.06			9.40			10.14	○					
SHM200-RN2-1-10-0.2-K		10		50	5.50	10.53	10.89	11.28			11.70			12.63	○					
SHM200-RN2-1-12-0.2-K		12		55	4.88	12.60	13.03	13.50			14.00			15.11	○					
SHM200-RN2-1-16-0.2-K		16		60	3.98	16.74	17.31	17.93			18.59			20.09	○					
SHM200-RN2-1-20-0.2-K		20		60	3.36	20.87	21.59	22.36			23.19			25.06	○					
SHM200-RN2-1-2-0.3-K		1	0.3	2	0.8	0.96	50	4	4	11.32	2.13	2.25	2.36	2.47	2.66	○				
SHM200-RN2-1-3-0.3-K				3			50			10.01	3.20	3.36	3.50	3.63	3.90	○				
SHM200-RN2-1-4-0.3-K	4			50			8.98			4.25	4.45	4.62	4.78	5.15	○					
SHM200-RN2-1-5-0.3-K	5			50			8.14			5.31	5.53	5.73	5.93	6.39	○					
SHM200-RN2-1-6-0.3-K	6			50			7.44			6.36	6.61	6.84	7.08	7.63	○					
SHM200-RN2-1-8-0.3-K	8			50			6.35			8.44	8.75	9.05	9.38	10.12	○					

● Stock ○ Available upon Order

R	Tol
R	±0.005

Unit(mm)

Recommended Cutting Data ※ P599

SHM200-RN2

2 Flutes with Extended Neck, Corner Radius

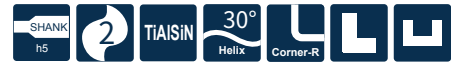
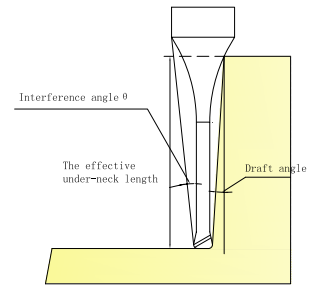
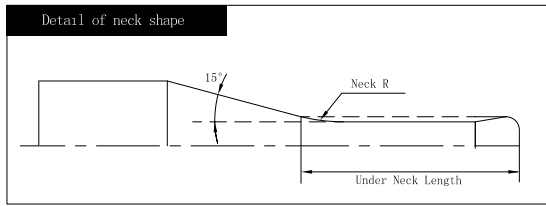

Please refer to page 167

» Continue

Ordering Code	Mill Dia. D	R	Under Neck Length L1	Flute Length Lc	Neck Dia. d2	Overall Length L	Shank Dia. d	Neck R	Interference Angle θ	The effective under-neck length for the various draft angles					Stock
										0.5°	1°	1.5°	2°	3°	
SHM200-RN2-1-10-0.3-K	1	0.3	10	0.8	0.96	50	4	4	5.53	10.52	10.89	11.27	11.68	12.60	○
SHM200-RN2-1-12-0.3-K			12			4.90				12.60	13.03	13.49	13.98	15.09	○
SHM200-RN2-1-16-0.3-K			16			4.00				16.73	17.30	17.92	18.58	20.06	○
SHM200-RN2-1-20-0.3-K			20			3.37				20.87	21.58	22.35	23.18	25.04	○
SHM200-RN2-1.25-5-0.1-K	1.25	0.1	5	1	1.20	50	4	4	7.68	5.30	5.52	5.72	5.93	6.40	○
SHM200-RN2-1.25-10-0.1-K			10			5.17				10.50	10.87	11.26	11.68	12.62	○
SHM200-RN2-1.25-15-0.1-K			15			3.90				15.68	16.22	16.80	17.43	18.83	○
SHM200-RN2-1.25-20-0.1-K			20			3.13				20.84	21.57	22.34	23.18	25.05	○
SHM200-RN2-1.25-5-0.2-K		0.2	5			7.75				5.29	5.51	5.71	5.91	6.38	○
SHM200-RN2-1.25-10-0.2-K			10			5.21				10.50	10.86	11.25	11.66	12.59	○
SHM200-RN2-1.25-15-0.2-K			15			3.92				15.67	16.21	16.79	17.41	18.81	○
SHM200-RN2-1.25-20-0.2-K			20			3.14				20.84	21.56	22.33	23.16	25.02	○
SHM200-RN2-1.25-5-0.3-K		0.3	5			7.83				5.29	5.50	5.70	5.90	6.35	○
SHM200-RN2-1.25-10-0.3-K			10			5.24				10.50	10.86	11.24	11.65	12.57	○
SHM200-RN2-1.25-15-0.3-K			15			3.94				15.67	16.20	16.78	17.40	18.78	○
SHM200-RN2-1.25-20-0.3-K			20			3.15				20.84	21.55	22.32	23.15	25.00	○
SHM200-RN2-1.5-4-0.1-K	1.5	0.1	4	1.2	1.44	50	4	4	8.17	4.23	4.42	4.58	4.75	5.13	○
SHM200-RN2-1.5-6-0.1-K			6			6.66				6.32	6.57	6.80	7.05	7.62	○
SHM200-RN2-1.5-8-0.1-K			8			5.62				8.41	8.71	9.02	9.35	10.10	○
SHM200-RN2-1.5-12-0.1-K			12			4.28				12.55	12.98	13.45	13.95	15.07	○
SHM200-RN2-1.5-15-0.1-K		15	3.63			15.65				16.19	16.77	17.40	18.80	○	
SHM200-RN2-1.5-20-0.1-K		20	2.90			20.82				21.54	22.32	23.15	-	○	
SHM200-RN2-1.5-4-0.2-K		0.2	4			8.26				4.23	4.41	4.57	4.74	5.10	○
SHM200-RN2-1.5-6-0.2-K			6			6.72				6.32	6.56	6.79	7.04	7.59	○

● Stock ○ Available upon Order

R	Tol
R	±0.005

Unit(mm)

Recommended Cutting Data ※ P599

SHM200-RN2

2 Flutes with Extended Neck, Corner Radius

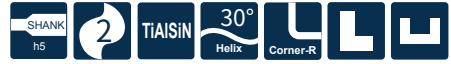
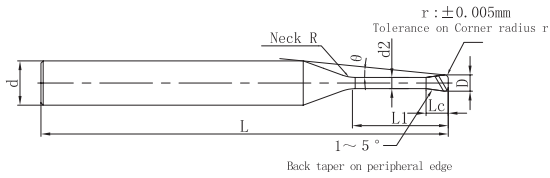

Please refer to page 167

» Continue

Ordering Code	Mill Dia. D	R	Under Neck Length L1	Flute Length Lc	Neck Dia. d2	Overall Length L	Shank Dia. d	Neck R	Interference Angle θ	The effective under-neck length for the various draft angles					Stock	
										0.5°	1°	1.5°	2°	3°		
SHM200-RN2-1.5-8-0.2-K	1.5	0.2	8	1.2	1.44	50	4	4	5.66	8.40	8.70	9.01	9.34	10.08	○	
SHM200-RN2-1.5-12-0.2-K			12			55				4.31	12.55	12.98	13.44	13.94	15.05	○
SHM200-RN2-1.5-15-0.2-K			15			55				3.65	15.65	16.19	16.76	17.38	18.78	○
SHM200-RN2-1.5-20-0.2-K			20			60				2.91	20.82	21.53	22.31	23.13	-	○
SHM200-RN2-1.5-4-0.3-K		0.3	4	1.2	1.44	50	4	4	8.36	4.22	4.40	4.56	4.72	5.08	○	
SHM200-RN2-1.5-6-0.3-K			6			50				6.78	6.31	6.55	6.78	7.02	7.57	○
SHM200-RN2-1.5-8-0.3-K			8			50				5.71	8.40	8.69	8.99	9.32	10.05	○
SHM200-RN2-1.5-12-0.3-K			12			55				4.33	12.54	12.97	13.43	13.92	15.03	○
SHM200-RN2-1.5-15-0.3-K		0.5	15	1.2	1.44	55	4	4	3.67	15.64	16.18	16.75	17.37	18.76	○	
SHM200-RN2-1.5-20-0.3-K			20			60				2.92	20.81	21.53	22.29	23.12	-	○
SHM200-RN2-1.5-4-0.5-K			4			50				8.55	4.21	4.39	4.54	4.69	5.03	○
SHM200-RN2-1.5-6-0.5-K			6			50				6.91	6.31	6.54	6.76	6.99	7.52	○
SHM200-RN2-1.5-8-0.5-K		0.5	8	1.2	1.44	50	4	4	5.80	8.39	8.68	8.97	9.29	10.00	○	
SHM200-RN2-1.5-12-0.5-K			12			55				4.39	12.54	12.96	13.41	13.89	14.98	○
SHM200-RN2-1.5-15-0.5-K			15			55				3.71	15.64	16.17	16.73	17.34	18.71	○
SHM200-RN2-1.5-20-0.5-K			20			60				2.95	20.81	21.51	22.27	23.09	-	○
SHM200-RN2-1.75-5-0.1-K	1.75	0.1	5	1.4	1.68	50	4	4	6.96	5.26	5.47	5.67	5.88	6.35	○	
SHM200-RN2-1.75-10-0.1-K			10			50				4.53	10.46	10.82	11.21	11.63	12.56	○
SHM200-RN2-1.75-15-0.1-K			15			55				3.35	15.63	16.17	16.75	17.38	18.78	○
SHM200-RN2-1.75-20-0.1-K			20			60				2.66	20.80	21.52	22.29	23.13	-	○
SHM200-RN2-1.75-5-0.2-K		0.2	5	1.4	1.68	50	4	4	7.03	5.26	5.47	5.66	5.86	6.32	○	
SHM200-RN2-1.75-10-0.2-K			10			50				4.56	10.46	10.82	11.20	11.61	12.54	○
SHM200-RN2-1.75-15-0.2-K			15			55				3.37	15.63	16.16	16.74	17.36	18.75	○
SHM200-RN2-1.75-20-0.2-K			20			60				2.67	20.80	21.51	22.28	23.11	-	○

● Stock ○ Available upon Order

R	Tol
R	±0.005

Unit(mm)

Recommended Cutting Data ※ P599

SHM200-RN2

2 Flutes with Extended Neck, Corner Radius

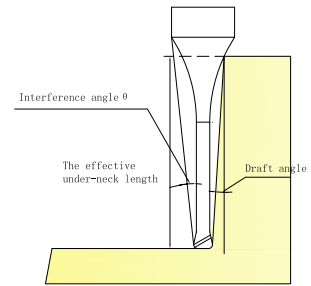
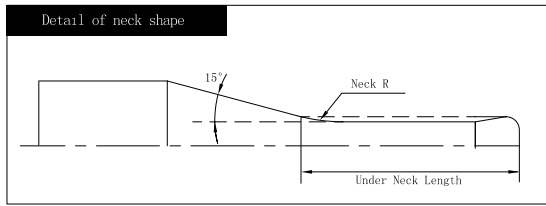

Please refer to page 167

» Continue

Ordering Code	Mill Dia. D	R	Under Neck Length L1	Flute Length Lc	Neck Dia. d2	Overall Length L	Shank Dia. d	Neck R	Interference Angle θ	The effective under-neck length for the various draft angles					Stock
										0.5°	1°	1.5°	2°	3°	
SHM200-RN2-1.75-5-0.3-K	1.75	0.3	5	1.4	1.68	50	4	4	7.11	5.25	5.46	5.65	5.85	6.30	○
SHM200-RN2-1.75-10-0.3-K			10			4.59			10.45	10.81	11.19	11.60	12.51	○	
SHM200-RN2-1.75-15-0.3-K			15			3.39			15.62	16.16	16.73	17.35	18.73	○	
SHM200-RN2-1.75-20-0.3-K			20			2.69			20.79	21.51	22.27	23.10	-	○	
SHM200-RN2-2-4-0.1-K	2	0.1	4	1.6	1.92	50	4	4	7.36	4.21	4.38	4.54	4.71	5.08	○
SHM200-RN2-2-6-0.1-K			6			5.86			6.29	6.53	6.76	7.01	7.57	○	
SHM200-RN2-2-8-0.1-K			8			4.87			8.37	8.66	8.97	9.31	10.05	○	
SHM200-RN2-2-12-0.1-K			12			3.64			12.51	12.94	13.41	13.91	15.03	○	
SHM200-RN2-2-16-0.1-K			16			2.90			16.65	17.22	17.84	18.51	-	○	
SHM200-RN2-2-20-0.1-K			20			2.42			20.78	21.50	22.27	23.11	-	○	
SHM200-RN2-2-25-0.1-K			25			2.00			25.95	26.85	27.82	-	-	○	
SHM200-RN2-2-30-0.1-K			30			1.70			31.12	32.20	33.36	-	-	○	
SHM200-RN2-2-4-0.2-K		0.2	4	1.6	1.92	50	4	4	7.46	4.20	4.37	4.53	4.69	5.06	○
SHM200-RN2-2-6-0.2-K			6			5.93			6.29	6.52	6.75	6.99	7.54	●	
SHM200-RN2-2-8-0.2-K			8			4.91			8.37	8.66	8.96	9.29	10.03	○	
SHM200-RN2-2-12-0.2-K			12			3.66			12.51	12.94	13.40	13.89	15.00	○	
SHM200-RN2-2-16-0.2-K			16			2.92			16.64	17.22	17.83	18.49	-	○	
SHM200-RN2-2-20-0.2-K			20			2.43			20.78	21.49	22.26	23.09	-	○	
SHM200-RN2-2-25-0.2-K			25			2.00			25.95	26.84	27.80	-	-	○	
SHM200-RN2-2-30-0.2-K			30			1.71			31.11	32.19	33.35	-	-	○	
SHM200-RN2-2-4-0.3-K	0.3	4	1.6	1.92	50	4	4	7.56	4.20	4.37	4.52	4.68	5.03	○	
SHM200-RN2-2-6-0.3-K		6			5.99			6.28	6.51	6.74	6.98	7.52	○		
SHM200-RN2-2-8-0.3-K		8			4.96			8.36	8.65	8.95	9.28	10.01	○		
SHM200-RN2-2-12-0.3-K		12			3.69			12.50	12.93	13.39	13.88	14.98	○		

● Stock ○ Available upon Order

R	Tol
R	±0.005

Unit(mm)

Recommended Cutting Data ※ P599

SHM200-RN2

2 Flutes with Extended Neck, Corner Radius

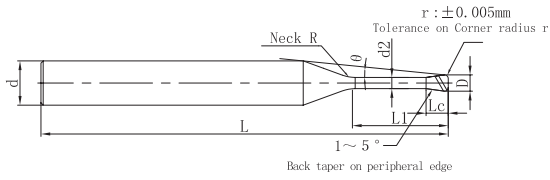

Please refer to page 167

» Continue

Ordering Code	Mill Dia. D	R	Under Neck Length L1	Flute Length Lc	Neck Dia. d2	Overall Length L	Shank Dia. d	Neck R	Interference Angle θ	The effective under-neck length for the various draft angles					Stock
										0.5°	1°	1.5°	2°	3°	
SHM200-RN2-2-16-0.3-K	2	0.3	16	1.6	1.92	55	4	4	2.93	16.64	17.21	17.82	18.48	-	○
SHM200-RN2-2-20-0.3-K			20			2.44			20.77	21.49	22.25	23.08	-	○	
SHM200-RN2-2-25-0.3-K			25			2.01			25.94	26.84	27.79	28.82	-	○	
SHM200-RN2-2-30-0.3-K			30			1.71			31.11	32.18	33.34	-	-	○	
SHM200-RN2-2-6-0.5-K		0.5	6			50			6.11	6.28	6.50	6.71	6.95	7.47	○
SHM200-RN2-2-8-0.5-K			8			5.04			8.36	8.64	8.93	9.25	9.96	○	
SHM200-RN2-2-12-0.5-K			12			3.73			12.50	12.92	13.36	13.85	14.93	○	
SHM200-RN2-2-16-0.5-K			16			2.96			16.63	17.19	17.80	18.45	-	○	
SHM200-RN2-2-20-0.5-K			20			2.46			20.77	21.47	22.23	23.05	-	○	
SHM200-RN2-2-25-0.5-K			25			2.03			25.94	26.82	27.77	28.79	-	○	
SHM200-RN2-2-30-0.5-K		30	1.72			31.10			32.17	33.31	-	-	○		
SHM200-RN2-2-6-0.8-K		0.8	6			50			6.31	6.26	6.48	6.68	6.90	7.40	○
SHM200-RN2-2-8-0.8-K			8			5.18			8.35	8.62	8.90	9.20	9.88	○	
SHM200-RN2-2-12-0.8-K			12			3.81			12.49	12.89	13.33	13.80	14.86	○	
SHM200-RN2-2-16-0.8-K			16			3.01			16.62	17.17	17.77	18.40	19.83	○	
SHM200-RN2-2-20-0.8-K			20			2.49			20.76	21.45	22.20	23.00	-	○	
SHM200-RN2-2-25-0.8-K			25			2.05			25.93	26.80	27.74	28.75	-	○	
SHM200-RN2-2-30-0.8-K		30	1.74			31.09			32.15	33.28	-	-	○		
SHM200-RN2-2.5-10-0.1-K	2.5	0.1	10	2	2.40	50	4	4	3.36	10.41	10.77	11.16	11.57	12.50	○
SHM200-RN2-2.5-20-0.1-K			20			1.89			20.75	21.47	22.24	-	-	○	
SHM200-RN2-2.5-30-0.1-K			30			1.32			31.09	32.17	-	-	-	○	
SHM200-RN2-2.5-10-0.2-K		0.2	10			50			3.39	10.41	10.77	11.15	11.56	12.48	○
SHM200-RN2-2.5-20-0.2-K			20			1.90			20.75	21.46	22.23	-	-	○	
SHM200-RN2-2.5-30-0.2-K			30			1.32			31.08	32.16	-	-	-	○	

● Stock ○ Available upon Order

R	Tol
R	±0.005

Unit(mm)

Recommended Cutting Data ※ P599

SHM200-RN2

2 Flutes with Extended Neck, Corner Radius

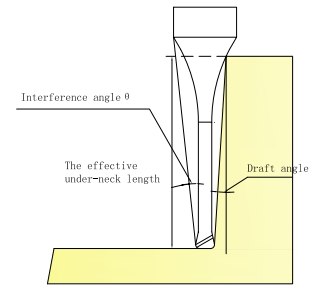
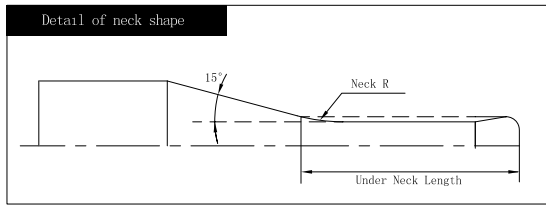

Please refer to page 167

» Continue

Ordering Code	Mill Dia. D	R	Under Neck Length L1	Flute Length Lc	Neck Dia. d2	Overall Length L	Shank Dia. d	Neck R	Interference Angle θ	The effective under-neck length for the various draft angles					Stock	
										0.5°	1°	1.5°	2°	3°		
SHM200-RN2-2.5-10-0.3-K	2.5	0.3	10	2	2.40	50	4	4	3.42	10.41	10.76	11.14	11.54	12.46	○	
SHM200-RN2-2.5-20-0.3-K			20			60				1.91	20.74	21.46	22.22	-	-	○
SHM200-RN2-2.5-30-0.3-K			30			70				1.32	31.08	32.15	-	-	-	○
SHM200-RN2-2.5-10-0.5-K		0.5	10			50				3.47	10.40	10.75	11.12	11.51	12.41	○
SHM200-RN2-2.5-20-0.5-K			20			60				1.92	20.74	21.44	22.20	-	-	○
SHM200-RN2-2.5-30-0.5-K			30			70				1.33	31.07	32.14	-	-	-	○
SHM200-RN2-3-6-0.1-K	3	0.1	6	2.4	2.88	50	6	4	7.40	6.25	6.47	6.70	6.95	7.50	○	
SHM200-RN2-3-8-0.1-K			8			55				6.32	8.32	8.61	8.92	9.25	9.99	○
SHM200-RN2-3-12-0.1-K			12			60				4.89	12.46	12.89	13.35	13.85	14.96	○
SHM200-RN2-3-16-0.1-K			16			60				3.99	16.59	17.17	17.78	18.45	19.94	○
SHM200-RN2-3-18-0.1-K			18			65				3.65	18.66	19.31	20.00	20.75	22.42	○
SHM200-RN2-3-20-0.1-K			20			65				3.36	20.73	21.45	22.22	23.05	24.91	○
SHM200-RN2-3-30-0.1-K			30			75				2.42	31.06	32.14	33.30	34.55	-	○
SHM200-RN2-3-35-0.1-K			35			80				2.12	36.23	37.49	38.84	40.29	-	○
SHM200-RN2-3-6-0.2-K			0.2			6				50	7.46	6.25	6.46	6.69	6.93	7.48
SHM200-RN2-3-8-0.2-K		8		55	6.36	8.32	8.60	8.91	9.23	9.97	○					
SHM200-RN2-3-12-0.2-K		12		60	4.92	12.45	12.88	13.34	13.83	14.94	○					
SHM200-RN2-3-16-0.2-K		16		60	4.00	16.59	17.16	17.77	18.43	19.91	○					
SHM200-RN2-3-18-0.2-K		18		65	3.66	18.66	19.30	19.99	20.73	22.40	○					
SHM200-RN2-3-20-0.2-K		20		65	3.38	20.72	21.44	22.21	23.03	24.88	○					
SHM200-RN2-3-30-0.2-K		30		75	2.43	31.06	32.14	33.29	34.53	-	○					
SHM200-RN2-3-35-0.2-K		35		80	2.13	36.23	37.48	38.83	40.28	-	○					
SHM200-RN2-3-6-0.3-K		0.3		6	50	7.53	6.24	6.46	6.68	6.92	7.46	○				
SHM200-RN2-3-8-0.3-K			8	55	6.41	8.32	8.60	8.90	9.22	9.94	○					

● Stock ○ Available upon Order

R	Tol
R	±0.005

Unit(mm)

Recommended Cutting Data ※ P599

SHM200-RN2

2 Flutes with Extended Neck, Corner Radius

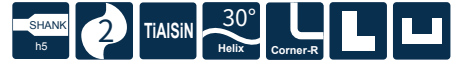
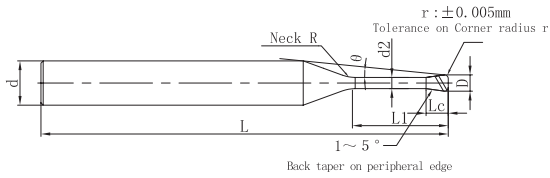

Please refer to page 167

» Continue

Ordering Code	Mill Dia. D	R	Under Neck Length L1	Flute Length Lc	Neck Dia. d2	Overall Length L	Shank Dia. d	Neck R	Interference Angle θ	The effective under-neck length for the various draft angles					Stock
										0.5°	1°	1.5°	2°	3°	
SHM200-RN2-3-12-0.3-K	2	0.3	12	2.4	2.88	60	6	4	4.94	12.45	12.87	13.33	13.82	14.91	○
SHM200-RN2-3-16-0.3-K			16			60			4.02	16.59	17.15	17.76	18.42	19.89	○
SHM200-RN2-3-18-0.3-K			18			65			3.68	18.65	19.29	19.98	20.72	22.37	○
SHM200-RN2-3-20-0.3-K			20			65			3.39	20.72	21.43	22.20	23.02	24.86	○
SHM200-RN2-3-30-0.3-K			30			75			2.43	31.06	32.13	33.28	34.52	-	○
SHM200-RN2-3-35-0.3-K			35			80			2.13	36.23	37.48	38.82	40.26	-	○
SHM200-RN2-3-8-0.5-K		0.5	8	2.4	2.88	55	6	4	6.51	8.31	8.58	8.87	9.19	9.89	○
SHM200-RN2-3-12-0.5-K			12			60			5.00	12.44	12.86	13.31	13.79	14.87	○
SHM200-RN2-3-16-0.5-K			16			60			4.06	16.58	17.14	17.74	18.39	19.84	○
SHM200-RN2-3-18-0.5-K			18			65			3.71	18.65	19.28	19.96	20.69	22.33	○
SHM200-RN2-3-20-0.5-K			20			65			3.42	20.71	21.42	22.17	22.99	24.81	○
SHM200-RN2-3-30-0.5-K			30			75			2.45	31.05	32.12	33.26	34.49	-	○
SHM200-RN2-3-35-0.5-K		35	80	2.14	36.22	37.46	38.80	40.23	-	○					
SHM200-RN2-3-8-1-K		1	8	2.4	2.88	55	6	4	6.76	8.29	8.55	8.82	9.11	9.77	○
SHM200-RN2-3-12-1-K			12			60			5.15	12.43	12.83	13.25	13.71	14.74	○
SHM200-RN2-3-16-1-K			16			60			4.16	16.56	17.10	17.69	18.31	19.72	○
SHM200-RN2-3-18-1-K			18			65			3.79	18.63	19.24	19.90	20.61	22.20	○
SHM200-RN2-3-20-1-K			20			65			3.49	20.70	21.38	22.12	22.91	24.69	○
SHM200-RN2-3-30-1-K			30			75			2.48	31.03	32.08	33.20	34.41	-	○
SHM200-RN2-3-35-1-K		35	80	2.17	36.20	37.43	38.74	40.16	-	○					
SHM200-RN2-4-8-0.1-K	4	0.1	8	3.2	3.86	55	6	4	4.90	8.31	8.59	8.90	9.23	9.97	○
SHM200-RN2-4-12-0.1-K			12			60			3.66	12.44	12.87	13.33	13.83	14.94	○
SHM200-RN2-4-16-0.1-K			16			60			2.91	16.57	17.15	17.76	18.43	-	○
SHM200-RN2-4-20-0.1-K			20			65			2.42	20.71	21.43	22.20	23.03	-	○

● Stock ○ Available upon Order

R	Tol
R	±0.005

Unit(mm)

Recommended Cutting Data ※ P599

SHM200-RN2

2 Flutes with Extended Neck, Corner Radius

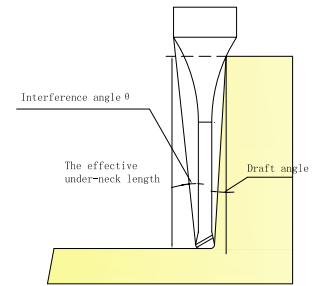
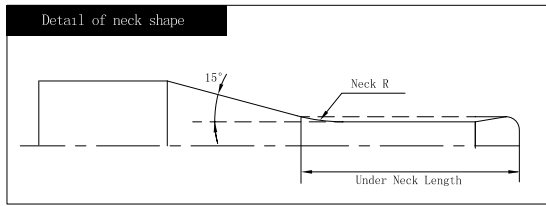

Please refer to page 167

» Continue

Ordering Code	Mill Dia. D	R	Under Neck Length L1	Flute Length Lc	Neck Dia. d2	Overall Length L	Shank Dia. d	Neck R	Interference Angle θ	The effective under-neck length for the various draft angles					Stock
										0.5°	1°	1.5°	2°	3°	
SHM200-RN2-4-30-0.1-K	4	0.1	30	3.2	3.86	75	6	4	1.71	31.05	32.12	33.28	-	-	○
SHM200-RN2-4-35-0.1-K			35			80			1.49	36.21	37.47	-	-	-	○
SHM200-RN2-4-45-0.1-K			45			90			1.18	46.55	48.17	-	-	-	○
SHM200-RN2-4-8-0.2-K		0.2	8			55			4.94	8.30	8.58	8.89	9.21	9.94	○
SHM200-RN2-4-12-0.2-K			12			60			3.68	12.44	12.86	13.32	13.81	14.92	○
SHM200-RN2-4-16-0.2-K			16			60			2.93	16.57	17.14	17.75	18.41	-	○
SHM200-RN2-4-20-0.2-K			20			65			2.43	20.71	21.42	22.19	23.01	-	○
SHM200-RN2-4-30-0.2-K			30			75			1.71	31.04	32.12	33.27	-	-	○
SHM200-RN2-4-35-0.2-K			35			80			1.49	36.21	37.47	-	-	-	○
SHM200-RN2-4-45-0.2-K		45	90			1.18			46.55	48.16	-	-	-	○	
SHM200-RN2-4-8-0.3-K		0.3	8			55			4.99	8.30	8.58	8.88	9.20	9.92	○
SHM200-RN2-4-12-0.3-K			12			60			3.70	12.43	12.86	13.31	13.80	14.89	○
SHM200-RN2-4-16-0.3-K			16			60			2.94	16.57	17.13	17.74	18.40	-	○
SHM200-RN2-4-20-0.3-K			20			65			2.44	20.70	21.41	22.18	23.00	-	○
SHM200-RN2-4-30-0.3-K			30			75			1.72	31.04	32.11	33.26	-	-	○
SHM200-RN2-4-35-0.3-K			35			80			1.49	36.21	37.46	-	-	-	○
SHM200-RN2-4-45-0.3-K		45	90			1.19			46.54	48.16	-	-	-	○	
SHM200-RN2-4-12-0.5-K		0.5	12			60			3.75	12.43	12.84	13.29	13.77	14.84	○
SHM200-RN2-4-16-0.5-K			16			60			2.97	16.56	17.12	17.72	18.37	-	○
SHM200-RN2-4-20-0.5-K			20			65			2.47	20.70	21.40	22.15	22.97	-	○
SHM200-RN2-4-30-0.5-K	30		75	1.73	31.03	32.10	33.24	-	-	○					
SHM200-RN2-4-35-0.5-K	35		80	1.50	36.20	37.44	-	-	-	○					
SHM200-RN2-4-45-0.5-K	45		90	1.19	46.54	48.14	-	-	-	○					
SHM200-RN2-4-12-1-K	1	12	60	3.88	12.41	12.81	13.23	13.69	14.72	○					

● Stock ○ Available upon Order

R	Tol
R	±0.005

Unit(mm)

Recommended Cutting Data ※ P599

SHM200-RN2

2 Flutes with Extended Neck, Corner Radius

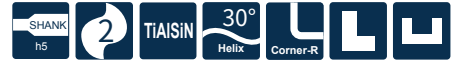
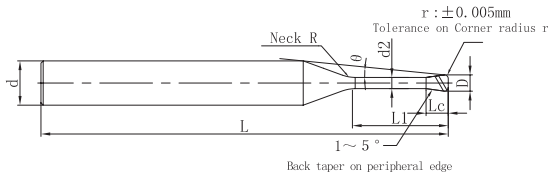

Please refer to page 167

» Continue

Ordering Code	Mill Dia. D	R	Under Neck Length L1	Flute Length Lc	Neck Dia. d2	Overall Length L	Shank Dia. d	Neck R	Interference Angle θ	The effective under-neck length for the various draft angles					Stock
										0.5°	1°	1.5°	2°	3°	
SHM200-RN2-4-16-1-K	4	1	16	3.2	3.86	60	6	4	3.05	16.54	17.09	17.67	18.29	19.70	○
SHM200-RN2-4-20-1-K			20			65			2.52	20.68	21.36	22.10	22.89	-	○
SHM200-RN2-4-30-1-K			30			75			1.75	31.02	32.06	33.18	-	-	○
SHM200-RN2-4-35-1-K			35			80			1.52	36.18	37.41	38.73	-	-	○
SHM200-RN2-4-45-1-K			45			90			1.20	46.52	48.11	-	-	-	○
SHM200-RN2-5-20-0.1-K	5	0.1	20	4	4.85	65	6	4	1.32	20.70	21.42	-	-	-	○
SHM200-RN2-5-40-0.1-K			40			85			0.69	41.38	-	-	-	○	
SHM200-RN2-5-20-0.2-K		0.2	20			65			1.32	20.70	21.41	-	-	-	○
SHM200-RN2-5-40-0.2-K			40			85			0.69	41.37	-	-	-	○	
SHM200-RN2-5-20-0.3-K		0.3	20			65			1.33	20.69	21.41	-	-	-	○
SHM200-RN2-5-40-0.3-K			40			85			0.69	41.37	-	-	-	○	
SHM200-RN2-5-20-0.5-K		0.5	20			65			1.34	20.69	21.39	-	-	-	○
SHM200-RN2-5-40-0.5-K			40			85			0.70	41.36	-	-	-	○	
SHM200-RN2-5-20-1-K		1	20			65			1.38	20.67	21.36	-	-	-	○
SHM200-RN2-5-40-1-K			40			85			0.71	41.34	-	-	-	○	
SHM200-RN2-6-12-0.1-K	6	0.1	12	4.8	5.85	50	6	-	-	-	-	-	-	-	○
SHM200-RN2-6-18-0.1-K			18			60			-	-	-	-	-	○	
SHM200-RN2-6-24-0.1-K			24			70			-	-	-	-	-	○	
SHM200-RN2-6-35-0.1-K			35			80			-	-	-	-	-	○	
SHM200-RN2-6-55-0.1-K			55			100			-	-	-	-	-	○	
SHM200-RN2-6-12-0.2-K		0.2	12			50			-	-	-	-	-	○	
SHM200-RN2-6-18-0.2-K			18			60			-	-	-	-	-	○	
SHM200-RN2-6-24-0.2-K			24			70			-	-	-	-	-	○	
SHM200-RN2-6-35-0.2-K			35			80			-	-	-	-	-	○	

● Stock ○ Available upon Order

R	Tol
R	±0.005

Unit(mm)

Recommended Cutting Data ※ P599

SHM200-RN2

2 Flutes with Extended Neck, Corner Radius

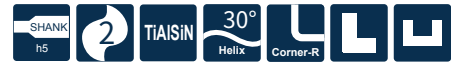
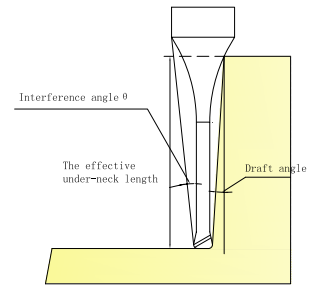
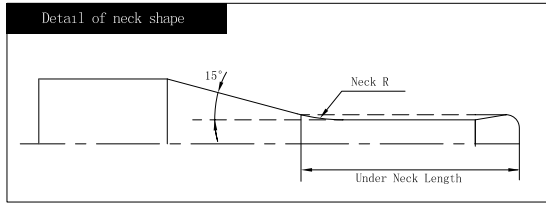

Please refer to page 167

» Continue

Ordering Code	Mill Dia. D	R	Under Neck Length L1	Flute Length Lc	Neck Dia. d2	Overall Length L	Shank Dia. d	Neck R	Interference Angle θ	The effective under-neck length for the various draft angles					Stock
										0.5°	1°	1.5°	2°	3°	
SHM200-RN2-6-55-0.2-K	6	0.2	55	4.8	5.85	100	6	-	-	-	-	-	-	-	○
SHM200-RN2-6-12-0.3-K			12			50			-	-	-	-	-	○	
SHM200-RN2-6-18-0.3-K			18			60			-	-	-	-	-	○	
SHM200-RN2-6-24-0.3-K			24			70			-	-	-	-	-	○	
SHM200-RN2-6-35-0.3-K			35			80			-	-	-	-	-	○	
SHM200-RN2-6-55-0.3-K			55			100			-	-	-	-	-	○	
SHM200-RN2-6-18-0.5-K		0.5	18	60	-	-	-	-	-	○					
SHM200-RN2-6-24-0.5-K			24	70	-	-	-	-	-	○					
SHM200-RN2-6-35-0.5-K			35	80	-	-	-	-	-	○					
SHM200-RN2-6-55-0.5-K			55	100	-	-	-	-	-	○					
SHM200-RN2-6-18-1-K		1	18	60	-	-	-	-	-	○					
SHM200-RN2-6-24-1-K			24	70	-	-	-	-	-	○					
SHM200-RN2-6-35-1-K			35	80	-	-	-	-	-	○					
SHM200-RN2-6-55-1-K			55	100	-	-	-	-	-	○					

● Stock ○ Available upon Order

R	Tol
R	±0.005

Unit(mm)

Recommended Cutting Data ※ P599

SHM200-RN4

4 Flutes with Extended Neck, Corner Radius

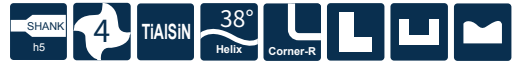
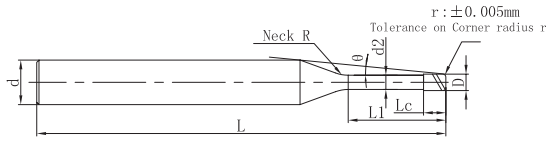

Please refer to page 167

Ordering Code	Mill Dia. D	R	Under Neck Length L1	Flute Length Lc	Neck Dia. d2	Overall Length L	Shank Dia. d	Neck R	Interference Angle θ	The effective under-neck length for the various draft angles					Stock	
										0.5°	1°	1.5°	2°	3°		
SHM200-RN4-1-4-0.05-K	1	0.05	4	0.8	0.96	50	4	4	8.75	4.27	4.47	4.65	4.82	5.21	○	
SHM200-RN4-1-6-0.05-K			6			50			7.28	6.37	6.63	6.86	7.12	7.69	○	
SHM200-RN4-1-8-0.05-K			8			50			6.23	8.45	8.76	9.08	9.42	10.18	○	
SHM200-RN4-1-10-0.05-K			10			50			5.45	10.53	10.90	11.30	11.72	12.67	○	
SHM200-RN4-1-12-0.05-K			12			60			4.84	12.61	13.04	13.51	14.02	15.15	○	
SHM200-RN4-1-16-0.05-K			16			60			3.95	16.74	17.32	17.95	18.62	20.12	○	
SHM200-RN4-1-20-0.05-K			20			60			3.34	20.88	21.60	22.38	23.22	25.10	○	
SHM200-RN4-1-4-0.1-K			0.1			4			50	8.80	4.26	4.47	4.64	4.81	5.19	○
SHM200-RN4-1-6-0.1-K		6		50	7.31	6.37	6.62	6.86	7.11	7.68	○					
SHM200-RN4-1-8-0.1-K		8		50	6.25	8.45	8.76	9.07	9.41	10.17	○					
SHM200-RN4-1-10-0.1-K		10		50	5.46	10.53	10.90	11.29	11.71	12.65	○					
SHM200-RN4-1-12-0.1-K		12		60	4.85	12.60	13.04	13.51	14.01	15.14	○					
SHM200-RN4-1-16-0.1-K		16		60	3.96	16.74	17.32	17.94	18.61	20.11	○					
SHM200-RN4-1-20-0.1-K		20		60	3.35	20.87	21.60	22.37	23.21	25.08	○					
SHM200-RN4-1.5-4-0.05-K		1.5		0.05	4	1.2	1.42	50	4	4	8.12	4.23	4.42	4.59	4.76	5.14
SHM200-RN4-1.5-8-0.05-K			8		50			5.60			8.41	8.71	9.02	9.36	10.11	○
SHM200-RN4-1.5-12-0.05-K	12		60		4.27			12.55			12.99	13.46	13.96	15.09	○	
SHM200-RN4-1.5-15-0.05-K	15		60		3.62			15.65			16.20	16.78	17.41	18.82	○	
SHM200-RN4-1.5-20-0.05-K	20		60		2.89			20.82			21.55	22.32	23.16	-	○	
SHM200-RN4-1.5-4-0.1-K	0.1		4	50	8.17	4.23	4.42	4.58	4.75	5.13	○					
SHM200-RN4-1.5-8-0.1-K			8	50	5.62	8.41	8.71	9.02	9.35	10.10	○					
SHM200-RN4-1.5-12-0.1-K			12	60	4.28	12.55	12.98	13.45	13.95	15.07	○					
SHM200-RN4-1.5-15-0.1-K			15	60	3.63	15.65	16.19	16.77	17.40	18.80	○					
SHM200-RN4-1.5-20-0.1-K			20	60	2.90	20.82	21.54	22.32	23.15	-	○					

●Stock ○Available upon Order

Tol	
R	±0.005
D	$\begin{matrix} 0 \\ -0.01 \end{matrix}$

Unit(mm)

Recommended Cutting Data ※ P621

SHM200-RN4

4 Flutes with Extended Neck, Corner Radius

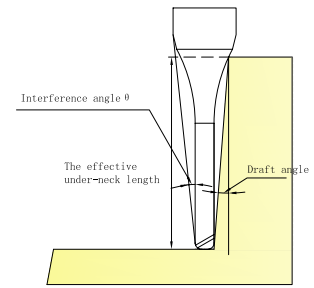
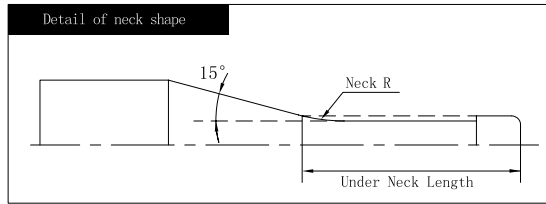

Please refer to page 167

» Continue

Ordering Code	Mill Dia. D	R	Under Neck Length L1	Flute Length Lc	Neck Dia. d2	Overall Length L	Shank Dia. d	Neck R	Interference Angle θ	The effective under-neck length for the various draft angles					Stock												
										0.5°	1°	1.5°	2°	3°													
SHM200-RN4-2-4-0.05-K	2	0.05	4	1.6	1.92	50	4	4	8.75	4.27	4.47	4.65	4.82	5.21	○												
SHM200-RN4-2-6-0.05-K			50			7.28			6.37	6.63	6.86	7.12	7.69	○													
SHM200-RN4-2-8-0.05-K			50			6.23			8.45	8.76	9.08	9.42	10.18	○													
SHM200-RN4-2-12-0.05-K			60			5.45			10.53	10.90	11.30	11.72	12.67	○													
SHM200-RN4-2-16-0.05-K			60			4.84			12.61	13.04	13.51	14.02	15.15	○													
SHM200-RN4-2-20-0.05-K			60			3.95			16.74	17.32	17.95	18.62	20.12	○													
SHM200-RN4-2-4-0.1-K			0.1			0.1			4	1.6	1.92	50	4	4	3.34	20.88	21.60	22.38	23.22	25.10	○						
SHM200-RN4-2-6-0.1-K									50			8.80			4.26	4.47	4.64	4.81	5.19	○							
SHM200-RN4-2-8-0.1-K									50			7.31			6.37	6.62	6.86	7.11	7.68	○							
SHM200-RN4-2-12-0.1-K									60			6.25			8.45	8.76	9.07	9.41	10.17	○							
SHM200-RN4-2-16-0.1-K									60			5.46			10.53	10.90	11.29	11.71	12.65	○							
SHM200-RN4-2-20-0.1-K									60			4.85			12.60	13.04	13.51	14.01	15.14	○							
SHM200-RN4-2-4-0.2-K									0.2			0.2			4	1.6	1.92	50	4	4	3.96	16.74	17.32	17.94	18.61	20.11	○
SHM200-RN4-2-6-0.2-K															50			3.35			20.87	21.60	22.37	23.21	25.08	○	
SHM200-RN4-2-8-0.2-K															50			8.12			4.23	4.42	4.59	4.76	5.14	○	
SHM200-RN4-2-12-0.2-K															60			5.60			8.41	8.71	9.02	9.36	10.11	●	
SHM200-RN4-2-16-0.2-K															60			4.27			12.55	12.99	13.46	13.96	15.09	○	
SHM200-RN4-2-20-0.2-K															60			3.62			15.65	16.20	16.78	17.41	18.82	○	
SHM200-RN4-2-25-0.2-K															70			2.89			20.82	21.55	22.32	23.16	-	○	
SHM200-RN4-2-30-0.2-K															70			8.17			4.23	4.42	4.58	4.75	5.13	○	
SHM200-RN4-2-4-0.3-K	0.3	0.3		4	1.6		1.92	50							4			4			5.62	8.41	8.71	9.02	9.35	10.10	○
SHM200-RN4-2-8-0.3-K				50				4.28													12.55	12.98	13.45	13.95	15.07	○	
SHM200-RN4-2-12-0.3-K				60				3.63													15.65	16.19	16.77	17.40	18.80	○	
SHM200-RN4-2-16-0.3-K				60				2.90													20.82	21.54	22.32	23.15	-	○	
SHM200-RN4-2-16-0.3-K				60				2.90													20.82	21.54	22.32	23.15	-	○	

● Stock ○ Available upon Order

Tol	
R	±0.005
D	$\begin{matrix} 0 \\ -0.01 \end{matrix}$

Unit(mm)

Recommended Cutting Data ※ P621

SHM200-RN4

4 Flutes with Extended Neck, Corner Radius

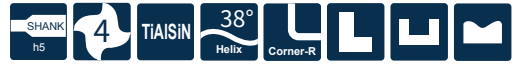
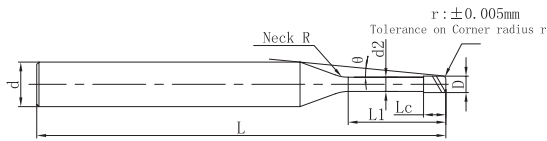

Please refer to page 167

» Continue

Ordering Code	Mill Dia. D	R	Under Neck Length L1	Flute Length Lc	Neck Dia. d2	Overall Length L	Shank Dia. d	Neck R	Interference Angle θ	The effective under-neck length for the various draft angles					Stock
										0.5°	1°	1.5°	2°	3°	
SHM200-RN4-2-20-0.3-K	2	0.3	20	1.6	1.92	60	4	4	2.44	20.77	21.49	22.25	23.08	-	○
SHM200-RN4-2-4-0.5-K			4			50			7.76	4.19	4.35	4.50	4.65	4.98	○
SHM200-RN4-2-6-0.5-K			6			50			6.11	6.28	6.50	6.71	6.95	7.47	○
SHM200-RN4-2-8-0.5-K			8			50			5.04	8.36	8.64	8.93	9.25	9.96	○
SHM200-RN4-2-12-0.5-K			12			50			3.73	12.50	12.92	13.36	13.85	14.93	○
SHM200-RN4-2-16-0.5-K			16			60			2.96	16.63	17.19	17.80	18.45	-	●
SHM200-RN4-2-20-0.5-K			20			60			2.46	20.77	21.47	22.23	23.05	-	○
SHM200-RN4-2-25-0.5-K			25			60			2.03	25.94	26.82	27.77	28.79	-	○
SHM200-RN4-2-30-0.5-K			30			50			1.72	31.10	32.17	33.31	-	-	○
SHM200-RN4-2.5-8-0.1-K			2.5			0.1			8	2	2.4	50	4	4	3.98
SHM200-RN4-2.5-16-0.1-K	16	50		2.29	16.62		17.19	17.81	18.47			-			○
SHM200-RN4-2.5-20-0.1-K	20	50		1.89	20.75		21.47	22.24	-			-			○
SHM200-RN4-2.5-8-0.2-K	8	60		4.02	8.34		8.63	8.93	9.26			9.99			○
SHM200-RN4-2.5-16-0.2-K	16	60		2.30	16.61		17.18	17.80	18.46			-			○
SHM200-RN4-2.5-20-0.2-K	20	60		1.90	20.75		21.46	22.23	-			-			○
SHM200-RN4-2.5-12-0.3-K	12	50		2.95	12.47		12.90	13.35	13.84			-			○
SHM200-RN4-2.5-20-0.3-K	20	50		1.91	20.74		21.46	22.22	-			-			○
SHM200-RN4-2.5-12-0.5-K	12	60		2.99	12.47		12.88	13.33	13.81			-			○
SHM200-RN4-2.5-20-0.5-K	20	60		1.92	20.74		21.44	22.20	-			-			○
SHM200-RN4-3-8-0.1-K	3	0.1	8	2.4	2.88	60	6	4	6.32	8.32	8.61	8.92	9.25	9.99	○
SHM200-RN4-3-16-0.1-K			16			50			3.99	16.59	17.17	17.78	18.45	19.94	○
SHM200-RN4-3-25-0.1-K			25			50			2.82	25.90	26.79	27.76	28.80	-	○
SHM200-RN4-3-30-0.1-K			30			60			2.42	31.06	32.14	33.30	34.55	-	○
SHM200-RN4-3-8-0.2-K			8			60			6.36	8.32	8.60	8.91	9.23	9.97	○

● Stock ○ Available upon Order

Tol	
R	±0.005
D	0 -0.01

Unit(mm)

Recommended Cutting Data ※ P621

SHM200-RN4

4 Flutes with Extended Neck, Corner Radius

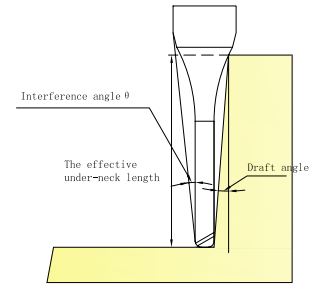
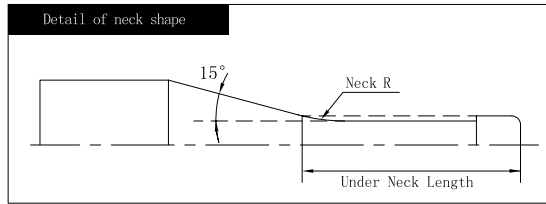

Please refer to page 167

» Continue

Ordering Code	Mill Dia. D	R	Under Neck Length L1	Flute Length Lc	Neck Dia. d2	Overall Length L	Shank Dia. d	Neck R	Interference Angle θ	The effective under-neck length for the various draft angles					Stock
										0.5°	1°	1.5°	2°	3°	
SHM200-RN4-3-12-0.2-K	3	0.2	12	2.4	2.88	60	6	4	4.92	12.45	12.88	13.34	13.83	14.94	○
SHM200-RN4-3-16-0.2-K			16			60			4.00	16.59	17.16	17.77	18.43	19.91	○
SHM200-RN4-3-20-0.2-K			20			70			3.38	20.72	21.44	22.21	23.03	24.88	○
SHM200-RN4-3-25-0.2-K			25			70			2.82	25.89	26.79	27.75	28.78	-	○
SHM200-RN4-3-30-0.2-K			30			80			2.43	31.06	32.14	33.29	34.53	-	○
SHM200-RN4-3-8-0.3-K			0.3			8			60	6.41	8.32	8.60	8.90	9.22	9.94
SHM200-RN4-3-16-0.3-K		16				60			4.02	16.59	17.15	17.76	18.42	19.89	○
SHM200-RN4-3-20-0.3-K		20				70			3.39	20.72	21.43	22.20	23.02	24.86	○
SHM200-RN4-3-25-0.3-K		25				70			2.83	25.89	26.78	27.74	28.77	-	○
SHM200-RN4-3-30-0.3-K		30				80			2.43	31.06	32.13	33.28	34.52	-	○
SHM200-RN4-3-8-0.5-K		0.5				8			60	6.51	8.31	8.58	8.87	9.19	9.89
SHM200-RN4-3-12-0.5-K			12			60			5.00	12.44	12.86	13.31	13.79	14.87	○
SHM200-RN4-3-16-0.5-K			16			60			4.06	16.58	17.14	17.74	18.39	19.84	○
SHM200-RN4-3-20-0.5-K			20			70			3.42	20.71	21.42	22.17	22.99	24.81	○
SHM200-RN4-3-25-0.5-K			25			70			2.85	25.88	26.77	27.72	28.74	-	●
SHM200-RN4-3-30-0.5-K			30			80			2.45	31.05	32.12	33.26	34.49	-	○
SHM200-RN4-3-35-0.5-K	35	80	2.14	36.22	37.46	38.80	40.23	-	○						
SHM200-RN4-4-12-0.1-K	4	0.1	12	3.2	3.86	60	6	4	3.66	12.44	12.87	13.33	13.83	14.94	○
SHM200-RN4-4-20-0.1-K			20			60			2.42	20.71	21.43	22.20	23.03	-	○
SHM200-RN4-4-30-0.1-K			30			80			1.71	31.05	32.12	33.28	-	-	○
SHM200-RN4-4-40-0.1-K		40	80			1.32			41.38	42.82	-	-	-	○	
SHM200-RN4-4-12-0.2-K		0.2	12			60			3.68	12.44	12.86	13.32	13.81	14.92	○
SHM200-RN4-4-20-0.2-K			20			60			2.43	20.71	21.42	22.19	23.01	-	○
SHM200-RN4-4-30-0.2-K			30			80			1.71	31.04	32.12	33.27	-	-	○

● Stock ○ Available upon Order

Tol	
R	±0.005
D	$\begin{matrix} 0 \\ -0.01 \end{matrix}$

Unit(mm)

Recommended Cutting Data ※ P621

SHM200-RN4

4 Flutes with Extended Neck, Corner Radius

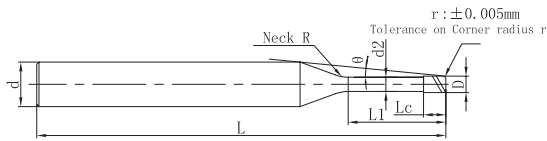

Please refer to page 167

» Continue

Ordering Code	Mill Dia. D	R	Under Neck Length L1	Flute Length Lc	Neck Dia. d2	Overall Length L	Shank Dia. d	Neck R	Interference Angle θ	The effective under-neck length for the various draft angles					Stock	
										0.5°	1°	1.5°	2°	3°		
SHM200-RN4-4-40-0.2-K	4	0.2	40	3.2	3.86	80	6	4	1.32	41.38	42.81	-	-	-	○	
SHM200-RN4-4-12-0.3-K			12			60			3.70	12.43	12.86	13.31	13.80	14.89	○	
SHM200-RN4-4-20-0.3-K			0.3			20			60	2.44	20.70	21.41	22.18	23.00	-	○
SHM200-RN4-4-30-0.3-K						30			80	1.72	31.04	32.11	33.26	-	-	○
SHM200-RN4-4-40-0.3-K						40			80	1.32	41.38	42.81	-	-	-	○
SHM200-RN4-4-12-0.5-K		0.5	12			60			3.75	12.43	12.84	13.29	13.77	14.84	○	
SHM200-RN4-4-20-0.5-K			20			60			2.47	20.70	21.40	22.15	22.97	-	○	
SHM200-RN4-4-30-0.5-K			30			80			1.73	31.03	32.10	33.24	-	-	○	
SHM200-RN4-4-40-0.5-K			40			80			1.33	41.37	42.79	-	-	-	○	
SHM200-RN4-5-20-0.1-K		5	0.1			20			4	4.85	70	6	4	1.32	20.70	21.42
SHM200-RN4-5-40-0.1-K	40			90	0.69	41.38	-	-			-			-	○	
SHM200-RN4-5-20-0.2-K	0.2		20	70	1.32	20.70	21.41	-			-			-	○	
SHM200-RN4-5-40-0.2-K			40	90	0.69	41.37	-	-			-			-	○	
SHM200-RN4-5-20-0.3-K	0.3		20	70	1.33	20.69	21.41	-			-			-	○	
SHM200-RN4-5-40-0.3-K			40	90	0.69	41.37	-	-			-			-	○	
SHM200-RN4-5-20-0.5-K	0.5		20	70	1.34	20.69	21.39	-			-			-	○	
SHM200-RN4-5-40-0.5-K			40	90	0.70	41.36	-	-			-			-	○	
SHM200-RN4-5-20-1-K	1		20	70	1.38	20.67	21.36	-			-			-	○	
SHM200-RN4-5-40-1-K			40	90	0.71	41.34	-	-			-			-	○	
SHM200-RN4-6-30-0.2-K	6	0.2	30	4.8	5.85	80	6	4	-	-	-	-	-	-	○	
SHM200-RN4-6-54-0.2-K			54			100			-	-	-	-	-	-	○	
SHM200-RN4-6-72-0.2-K			72			120			-	-	-	-	-	-	○	
SHM200-RN4-6-30-0.3-K		0.3	30			80			-	-	-	-	-	-	○	
SHM200-RN4-6-54-0.3-K			54			100			-	-	-	-	-	-	○	
																○

● Stock ○ Available upon Order

Tol	
R	±0.005
D	0 -0.01

Unit(mm)

Recommended Cutting Data ※ P621

SHM200-RN4

4 Flutes with Extended Neck, Corner Radius

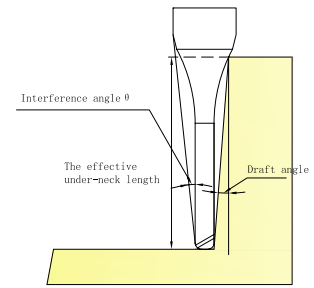
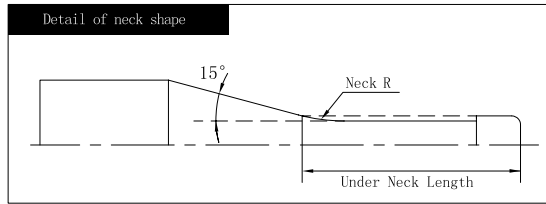

Please refer to page 167

» Continue

Ordering Code	Mill Dia. D	R	Under Neck Length L1	Flute Length Lc	Neck Dia. d2	Overall Length L	Shank Dia. d	Neck R	Interference Angle θ	The effective under-neck length for the various draft angles					Stock				
										0.5°	1°	1.5°	2°	3°					
SHM200-RN4-6-72-0.3-K	6	0.3	72	4.8	5.85	120	6	4	-	-	-	-	-	-	-	○			
SHM200-RN4-6-30-0.5-K			30			80				-	-	-	-	-	○				
SHM200-RN4-6-54-0.5-K		0.5	54			100				-	-	-	-	-	○				
SHM200-RN4-6-72-0.5-K			72			120				-	-	-	-	-	○				
SHM200-RN4-6-30-1-K		1	0.5			30				80	-	-	-	-	-	-	-	-	○
SHM200-RN4-6-54-1-K						54				100	-	-	-	-	-	-	-	-	○
SHM200-RN4-6-72-1-K						72				120	-	-	-	-	-	-	-	-	-
SHM200-RN4-6-72-1-K	72			120	-	-	-	-	-	-	-	-	-	○					

● Stock ○ Available upon Order

Tol	
R	±0.005
D	$\begin{matrix} 0 \\ -0.01 \end{matrix}$

Unit(mm)

Recommended Cutting Data ※ P621

SHM200-BN2

2 Flutes with Extended Neck, Ballnose

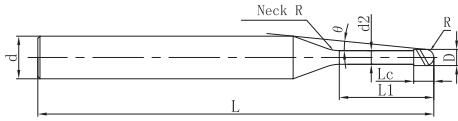

Please refer to page 167

Ordering Code	Mill Dia. D	R	Under Neck Length L1	Flute Length Lc	Neck Dia. d2	Overall Length L	Shank Dia. d	Neck R	Interference Angle θ	The effective under-neck length for the various draft angles					Stock								
										0.5°	1°	1.5°	2°	3°									
SHM200-BN2-0.1-0.2-K	0.1	0.05	0.2	0.08	0.08	50	4	1	14.66	0.2	0.21	0.22	0.24	0.26	○								
SHM200-BN2-0.1-0.3-K			0.3							0.31	0.33	0.34	0.36	0.39	○								
SHM200-BN2-0.1-0.5-K			0.5							14.12	0.52	0.55	0.57	0.59	0.64	●							
SHM200-BN2-0.2-0.5-K	0.2	0.1	0.5	0.16	0.17	50	4	1	14.21	0.51	0.53	0.55	0.57	0.61	●								
SHM200-BN2-0.2-0.75-K			0.75							13.77	0.78	0.8	0.83	0.86	0.92	○							
SHM200-BN2-0.2-1-K			1							13.36	1.04	1.07	1.11	1.15	1.23	○							
SHM200-BN2-0.2-1.25-K			1.25							12.97	1.3	1.34	1.39	1.43	1.54	○							
SHM200-BN2-0.2-1.5-K			1.5							12.6	1.56	1.61	1.66	1.72	1.85	○							
SHM200-BN2-0.2-2-K			2							11.92	2.07	2.14	2.22	2.3	2.48	○							
SHM200-BN2-0.2-2.5-K			2.5							11.31	2.59	2.68	2.77	2.87	3.1	○							
SHM200-BN2-0.2-3-K			3							10.76	3.11	3.21	3.33	3.45	3.72	○							
SHM200-BN2-0.3-0.5-K			0.3							0.15	0.5	0.24	0.27	50	4	2	14.17	0.52	0.55	0.57	0.6	0.66	●
SHM200-BN2-0.3-0.75-K											0.75							13.72	0.79	0.83	0.87	0.91	0.98
SHM200-BN2-0.3-1-K	1	13.3		1.05	1.11	1.16	1.2	1.29	○														
SHM200-BN2-0.3-1.25-K	1.25	12.9		1.32	1.38	1.44	1.5	1.61	○														
SHM200-BN2-0.3-1.5-K	1.5	12.53		1.58	1.66	1.72	1.78	1.92	○														
SHM200-BN2-0.3-2-K	2	11.84		2.11	2.2	2.28	2.36	2.54	○														
SHM200-BN2-0.3-2.5-K	2.5	11.22		2.63	2.74	2.83	2.93	3.16	●														
SHM200-BN2-0.3-3-K	3	10.66		3.15	3.27	3.39	3.51	3.78	○														
SHM200-BN2-0.4-0.75-K	0.4	0.2	0.75	0.32	0.37	50	4	2	13.78	0.78	0.82	0.86	0.9	0.97	●								
SHM200-BN2-0.4-1-K			1							13.34	1.05	1.1	1.15	1.19	1.28	○							
SHM200-BN2-0.4-1.5-K			1.5							12.55	1.58	1.65	1.72	1.78	1.9	○							
SHM200-BN2-0.4-2-K			2							11.84	2.11	2.19	2.27	2.35	2.53	○							
SHM200-BN2-0.4-2.5-K			2.5							11.2	2.63	2.73	2.83	2.93	3.15	○							

● Stock ○ Available upon Order

R	Tol
R ≤ 1.0	±0.003
R > 1.0	±0.005

Unit (mm)

Recommended Cutting Data ※ P626

SHM200-BN2

2 Flutes with Extended Neck, Ballnose

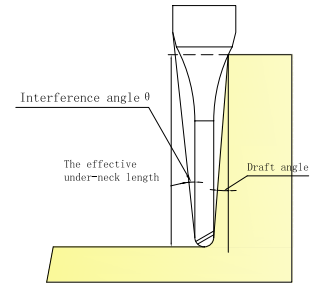
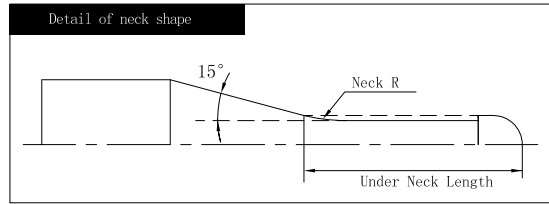

Please refer to page 167

» Continue

Ordering Code	Mill Dia. D	R	Under Neck Length L1	Flute Length Lc	Neck Dia. d2	Overall Length L	Shank Dia. d	Neck R	Interference Angle θ	The effective under-neck length for the various draft angles					Stock
										0.5°	1°	1.5°	2°	3°	
SHM200-BN2-0.4-3-K	0.4	0.2	3	0.32	0.37	50	4	2	10.63	3.15	3.27	3.38	3.5	3.77	○
SHM200-BN2-0.4-3.5-K			3.5							3.67	3.8	3.94	4.08	4.39	●
SHM200-BN2-0.4-4-K			4							4.19	4.34	4.49	4.65	5.01	●
SHM200-BN2-0.4-4.5-K			4.5							4.71	4.87	5.04	5.23	5.63	○
SHM200-BN2-0.5-1-K	0.5	0.25	1	0.4	0.47	50	4	2	13.39	1.05	1.09	1.14	1.19	1.27	○
SHM200-BN2-0.5-1.5-K			1.5							1.58	1.65	1.71	1.77	1.89	○
SHM200-BN2-0.5-2-K			2							2.1	2.19	2.27	2.34	2.51	●
SHM200-BN2-0.5-2.5-K			2.5							2.63	2.73	2.82	2.92	3.14	○
SHM200-BN2-0.5-3-K			3							3.15	3.27	3.38	3.49	3.76	●
SHM200-BN2-0.5-4-K			4							4.19	4.34	4.48	4.64	5	●
SHM200-BN2-0.5-5-K			5							5.23	5.41	5.59	5.79	6.24	○
SHM200-BN2-0.5-5.5-K			5.5							5.75	5.94	6.15	6.37	6.86	○
SHM200-BN2-0.5-6-K			6							6.27	6.48	6.7	6.94	7.49	○
SHM200-BN2-0.5-8-K			8							8.33	8.62	8.92	9.24	9.97	○
SHM200-BN2-0.6-1-K	0.6	0.3	1	0.48	0.57	50	4	4	13.15	1.07	1.14	1.2	1.27	1.41	○
SHM200-BN2-0.6-2-K			2							2.15	2.28	2.39	2.5	2.7	●
SHM200-BN2-0.6-2.5-K			2.5							2.68	2.84	2.97	3.09	3.32	○
SHM200-BN2-0.6-3-K			3							3.22	3.39	3.54	3.67	3.95	●
SHM200-BN2-0.6-3.5-K			3.5							3.75	3.94	4.1	4.25	4.57	●
SHM200-BN2-0.6-4-K			4							4.28	4.48	4.66	4.82	5.19	●
SHM200-BN2-0.6-4.5-K			4.5							4.81	5.03	5.21	5.4	5.81	○
SHM200-BN2-0.6-5-K			5							5.33	5.57	5.77	5.97	6.43	○
SHM200-BN2-0.6-5.5-K			5.5							5.86	6.11	6.32	6.55	7.05	○
SHM200-BN2-0.6-6-K			6							6.38	6.64	6.87	7.12	7.67	○

● Stock ○ Available upon Order

R	Tol
R ≤ 1.0	±0.003
R > 1.0	±0.005

Unit (mm)

Recommended Cutting Data ※ P626

SHM200-BN2

2 Flutes with Extended Neck, Ballnose

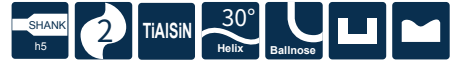
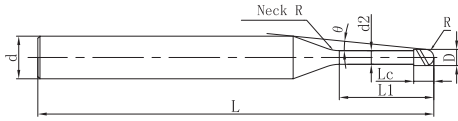

Please refer to page 167

» Continue

Ordering Code	Mill Dia. D	R	Under Neck Length L1	Flute Length Lc	Neck Dia. d2	Overall Length L	Shank Dia. d	Neck R	Interference Angle θ	The effective under-neck length for the various draft angles					Stock
										0.5°	1°	1.5°	2°	3°	
SHM200-BN2-0.6-7-K	0.6	0.3	7	0.48	0.57	50	4	4	7.3	7.43	7.71	7.98	8.27	8.92	○
SHM200-BN2-0.6-8-K			8						6.79	8.48	8.78	9.09	9.42	10.16	○
SHM200-BN2-0.6-9-K			9						6.35	9.52	9.85	10.2	10.57	11.4	○
SHM200-BN2-0.6-10-K			10						5.97	10.56	10.92	11.31	11.72	12.65	○
SHM200-BN2-0.6-12-K			12						5.32	12.63	13.06	13.52	14.02	15.13	○
SHM200-BN2-0.7-2-K	0.7	0.35	2	0.56	0.67	50	4	4	11.6	2.14	2.27	2.39	2.49	2.69	○
SHM200-BN2-0.7-4-K			4						9.33	4.27	4.48	4.65	4.81	5.18	○
SHM200-BN2-0.7-6-K			6						7.81	6.38	6.64	6.87	7.11	7.66	○
SHM200-BN2-0.7-8-K			8						6.71	8.47	8.78	9.09	9.41	10.15	○
SHM200-BN2-0.8-2-K	0.8	0.4	2	0.64	0.76	50	4	4	11.64	2.12	2.24	2.35	2.45	2.63	●
SHM200-BN2-0.8-4-K			4						9.3	4.25	4.44	4.61	4.77	5.12	○
SHM200-BN2-0.8-5-K			5						8.45	5.3	5.53	5.72	5.92	6.36	○
SHM200-BN2-0.8-6-K			6						7.74	6.35	6.6	6.83	7.07	7.61	○
SHM200-BN2-0.8-8-K			8						6.63	8.44	8.74	9.04	9.37	10.09	○
SHM200-BN2-0.8-10-K	10	5.8	10.52	10.88	11.26	11.67	12.58	○							
SHM200-BN2-0.9-2-K	0.9	0.45	2	0.72	0.86	50	4	4	11.63	2.12	2.23	2.34	2.44	2.62	○
SHM200-BN2-0.9-4-K			4						9.24	4.25	4.44	4.6	4.76	5.11	○
SHM200-BN2-0.9-6-K			6						7.66	6.35	6.6	6.82	7.06	7.6	○
SHM200-BN2-0.9-8-K			8						6.54	8.44	8.74	9.04	9.36	10.08	○
SHM200-BN2-1-2-K	1	0.5	2	0.8	0.96	50	4	4	11.62	2.12	2.23	2.33	2.43	2.61	●
SHM200-BN2-1-3-K			3			10.25			3.18	3.34	3.48	3.6	3.85	●	
SHM200-BN2-1-4-K			4			9.17			4.24	4.43	4.6	4.75	5.1	●	
SHM200-BN2-1-5-K			5			8.29			5.3	5.52	5.71	5.9	6.34	●	
SHM200-BN2-1-6-K			6			7.57			6.35	6.59	6.81	7.05	7.58	●	

● Stock ○ Available upon Order

R	Tol
R ≤ 1.0	±0.003
R > 1.0	±0.005

Unit (mm)

Recommended Cutting Data ※ P626

SHM200-BN2

2 Flutes with Extended Neck, Ballnose

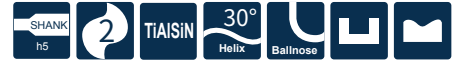
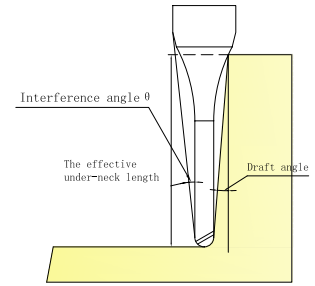
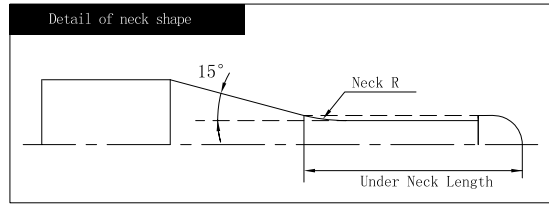

Please refer to page 167

» Continue

Ordering Code	Mill Dia. D	R	Under Neck Length L1	Flute Length Lc	Neck Dia. d2	Overall Length L	Shank Dia. d	Neck R	Interference Angle θ	The effective under-neck length for the various draft angles					Stock
										0.5°	1°	1.5°	2°	3°	
SHM200-BN2-1-7-K	1	0.5	7	0.8	0.96	50	4	4	6.96	7.39	7.66	7.92	8.2	8.83	○
SHM200-BN2-1-8-K			8			50			6.44	8.44	8.73	9.03	9.35	10.07	●
SHM200-BN2-1-9-K			9			50			5.99	9.48	9.8	10.14	10.5	11.31	○
SHM200-BN2-1-10-K			10			50			5.6	10.52	10.87	11.25	11.65	12.56	●
SHM200-BN2-1-12-K			12			4.96			12.59	13.01	13.46	13.95	15.04	●	
SHM200-BN2-1-13-K			13			4.69			13.62	14.08	14.57	15.1	16.29	○	
SHM200-BN2-1-14-K			14			4.45			14.66	15.15	15.68	16.25	17.53	○	
SHM200-BN2-1-16-K			16			4.03			16.73	17.29	17.9	18.55	20.01	○	
SHM200-BN2-1-18-K			18			3.69			18.79	19.43	20.11	20.85	22.5	○	
SHM200-BN2-1-20-K			20			3.4			20.86	21.57	22.33	23.15	24.99	○	
SHM200-BN2-1.1-2-K	1.1	0.55	2	0.88	1.06	50	4	4	11.61	2.11	2.22	2.32	2.42	2.6	○
SHM200-BN2-1.1-4-K			4						9.09	4.24	4.43	4.59	4.74	5.08	○
SHM200-BN2-1.1-6-K			6						7.47	6.34	6.59	6.81	7.04	7.57	○
SHM200-BN2-1.1-8-K			8						6.34	8.43	8.73	9.03	9.34	10.06	○
SHM200-BN2-1.1-10-K			10						5.5	10.51	10.87	11.24	11.64	12.54	○
SHM200-BN2-1.2-4-K	1.2	0.6	4	0.96	1.15	50	4	4	9.05	4.22	4.4	4.55	4.7	5.04	●
SHM200-BN2-1.2-8-K			8						6.25	8.41	8.7	8.99	9.3	10.01	○
SHM200-BN2-1.2-10-K			10						5.41	10.49	10.84	11.21	11.6	12.5	○
SHM200-BN2-1.2-12-K			12						4.77	12.56	12.97	13.42	13.9	14.98	○
SHM200-BN2-1.4-8-K	1.4	0.7	8	1.12	1.34	50	4	4	6.04	8.38	8.66	8.95	9.26	9.96	○
SHM200-BN2-1.4-12-K			12						4.56	12.53	12.94	13.38	13.86	14.93	○
SHM200-BN2-1.4-16-K			16						3.67	16.66	17.22	17.82	18.46	19.9	○
SHM200-BN2-1.5-4-K	1.5	0.75	4	1.2	1.44	50	4	4	8.82	4.2	4.36	4.51	4.65	4.97	○
SHM200-BN2-1.5-6-K			6						7.08	6.29	6.52	6.73	6.95	7.46	○

● Stock ○ Available upon Order

R	Tol
R ≤ 1.0	±0.003
R > 1.0	±0.005

Unit (mm)

Recommended Cutting Data ※ P626

SHM200-BN2

2 Flutes with Extended Neck, Ballnose

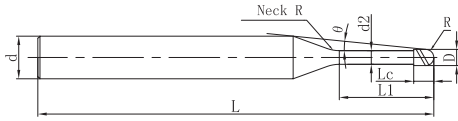

Please refer to page 167

» Continue

Ordering Code	Mill Dia. D	R	Under Neck Length L1	Flute Length Lc	Neck Dia. d2	Overall Length L	Shank Dia. d	Neck R	Interference Angle θ	The effective under-neck length for the various draft angles					Stock
										0.5°	1°	1.5°	2°	3°	
SHM200-BN2-1.5-8-K	1.5	0.75	8	1.2	1.44	50	4	4	5.92	8.38	8.66	8.95	9.25	9.94	○
SHM200-BN2-1.5-10-K			10			50			5.08	10.46	10.8	11.16	11.55	12.43	○
SHM200-BN2-1.5-12-K			12			55			4.45	12.53	12.94	13.38	13.85	14.92	○
SHM200-BN2-1.5-14-K			14			55			3.96	14.6	15.08	15.6	16.15	17.4	○
SHM200-BN2-1.5-16-K			16			60			3.57	16.66	17.22	17.81	18.45	19.89	○
SHM200-BN2-1.5-18-K			18			60			3.25	18.73	19.36	20.03	20.75	22.38	○
SHM200-BN2-1.5-20-K			20			60			2.98	20.8	21.5	22.25	23.05	-	○
SHM200-BN2-1.6-8-K	1.6	0.8	8	1.28	1.54	50	4	4	5.8	8.38	8.66	8.94	9.25	9.93	○
SHM200-BN2-1.6-12-K			12			55			4.34	12.53	12.94	13.37	13.85	14.9	○
SHM200-BN2-1.6-16-K			16			55			3.47	16.66	17.21	17.81	18.44	19.88	○
SHM200-BN2-1.6-20-K			20			60			2.89	20.8	21.49	22.24	23.04	-	○
SHM200-BN2-1.8-8-K			8			50			5.55	8.36	8.63	8.91	9.21	9.88	○
SHM200-BN2-1.8-12-K	8	55	4.11	12.5	12.91	13.34	13.81	14.85	○						
SHM200-BN2-1.8-16-K	1.8	0.9	16	1.44	1.73	55	4	4	3.26	16.64	17.19	17.77	18.41	19.83	○
SHM200-BN2-1.8-20-K			20			60			2.7	20.77	21.46	22.21	23.01	-	○
SHM200-BN2-2-3-K	2	1	3	1.6	1.92	50	4	4	9.72	3.11	3.22	3.32	3.42	3.62	○
SHM200-BN2-2-4-K			4			50			8.32	4.16	4.31	4.44	4.57	4.86	●
SHM200-BN2-2-6-K			6			50			6.46	6.26	6.46	6.66	6.87	7.35	●
SHM200-BN2-2-8-K			8			50			5.27	8.34	8.6	8.88	9.17	9.84	●
SHM200-BN2-2-10-K			10			50			4.46	10.41	10.74	11.09	11.47	12.32	●
SHM200-BN2-2-12-K			12			55			3.86	12.48	12.88	13.31	13.77	14.81	●
SHM200-BN2-2-13-K			13			55			3.62	13.51	13.95	14.42	14.92	16.05	○
SHM200-BN2-2-14-K			14			55			3.4	14.55	15.02	15.53	16.07	17.29	○
SHM200-BN2-2-16-K			16			55			3.04	16.62	17.16	17.74	18.37	19.78	●

● Stock ○ Available upon Order

R	Tol
R ≤ 1.0	±0.003
R > 1.0	±0.005

Unit (mm)

Recommended Cutting Data ※ P626

SHM200-BN2

2 Flutes with Extended Neck, Ballnose

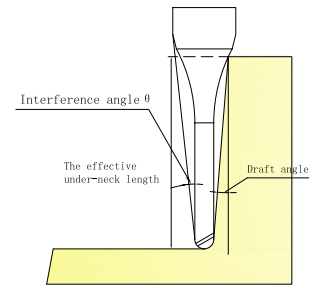
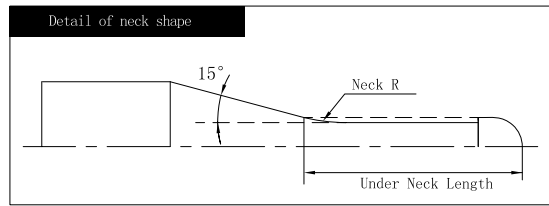

Please refer to page 167

» Continue

Ordering Code	Mill Dia. D	R	Under Neck Length L1	Flute Length Lc	Neck Dia. d2	Overall Length L	Shank Dia. d	Neck R	Interference Angle θ	The effective under-neck length for the various draft angles					Stock
										0.5°	1°	1.5°	2°	3°	
SHM200-BN2-2-18-K	2	1	18	1.6	1.92	60	4	4	2.75	18.68	19.3	19.96	20.67	-	○
SHM200-BN2-2-20-K			20			60			2.51	20.75	21.44	22.18	22.97	-	○
SHM200-BN2-2-22-K			22			60			2.31	22.82	23.58	24.39	25.27	-	○
SHM200-BN2-2-25-K			25			65			2.06	25.92	26.79	27.72	28.72	-	○
SHM200-BN2-2-30-K			30			70			1.75	31.09	32.14	33.26	-	-	○
SHM200-BN2-2-35-K			35			75			1.52	36.26	37.48	38.8	-	-	○
SHM200-BN2-2-40-K			40			80			1.34	41.42	42.83	-	-	-	○
SHM200-BN2-2.5-6-K	2.5	1.25	6	2	2.4	50	4	4	5.62	6.22	6.41	6.6	6.8	7.25	○
SHM200-BN2-2.5-10-K			10			50			3.69	10.37	10.69	11.03	11.4	12.23	○
SHM200-BN2-2.5-15-K			15			55			2.59	15.54	16.04	16.58	17.15	-	○
SHM200-BN2-2.5-20-K			20			60			1.99	20.71	21.39	22.12	-	-	○
SHM200-BN2-2.5-25-K			25			65			1.62	25.88	26.74	27.66	-	-	○
SHM200-BN2-2.5-30-K			30			70			1.36	31.05	32.09	-	-	-	○
SHM200-BN2-3-8-K	3	1.5	8	2.4	2.88	55	6	4	7.04	8.27	8.51	8.77	9.04	9.65	○
SHM200-BN2-3-10-K			10			55			6.05	10.34	10.65	10.98	11.34	12.14	○
SHM200-BN2-3-13-K			13			60			5	13.44	13.86	14.31	14.79	15.87	○
SHM200-BN2-3-16-K			16			60			4.26	16.55	17.07	17.63	18.24	19.6	●
SHM200-BN2-3-20-K			20			65			3.56	20.68	21.35	22.07	22.84	24.57	○
SHM200-BN2-3-25-K			25			70			2.95	25.85	26.7	27.61	28.59	-	●
SHM200-BN2-3-30-K			30			75			2.52	31.02	32.05	33.15	34.34	-	●
SHM200-BN2-3-35-K			35			80			2.2	36.19	37.39	38.69	40.08	-	○
SHM200-BN2-3.5-15-K	3.5	1.75	15	2.8	3.36	60	6	4	3.99	15.49	15.96	16.48	17.03	18.27	○
SHM200-BN2-3.5-25-K			25			70			2.56	25.82	26.66	27.56	28.53	-	○
SHM200-BN2-3.5-35-K			35			80			1.89	36.16	37.36	38.64	-	-	○

● Stock ○ Available upon Order

R	Tol
R ≤ 1.0	±0.003
R > 1.0	±0.005

Unit (mm)

Recommended Cutting Data ※ P626

SHM200-BN2

2 Flutes with Extended Neck, Ballnose

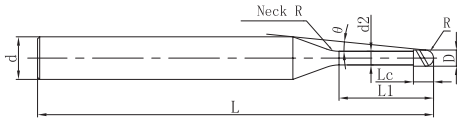

Please refer to page 167

» Continue

Ordering Code	Mill Dia. D	R	Under Neck Length L1	Flute Length Lc	Neck Dia. d2	Overall Length L	Shank Dia. d	Neck R	Interference Angle θ	The effective under-neck length for the various draft angles					Stock
										0.5°	1°	1.5°	2°	3°	
SHM200-BN2-3.5-45-K	3.5	1.75	45	2.8	3.36	90	6	4	1.5	46.5	48.05	-	-	-	○
SHM200-BN2-4-10-K	4	2	10	3.2	3.86	55	6	4	4.86	10.31	10.6	10.91	11.24	11.99	○
SHM200-BN2-4-13-K			13			60			3.88	13.41	13.81	14.23	14.69	15.72	○
SHM200-BN2-4-16-K			16			60			3.23	16.51	17.02	17.56	18.14	19.45	○
SHM200-BN2-4-20-K			20			65			2.63	20.65	21.3	21.99	22.74	-	○
SHM200-BN2-4-25-K			25			70			2.14	25.81	26.64	27.53	28.49	-	●
SHM200-BN2-4-30-K			30			75			1.81	30.98	31.99	33.08	-	-	○
SHM200-BN2-4-35-K			35			80			1.56	36.15	37.34	38.62	-	-	○
SHM200-BN2-4-40-K			40			80			1.38	41.32	42.69	-	-	-	○
SHM200-BN2-4-45-K			45			90			1.23	46.49	48.04	-	-	-	○
SHM200-BN2-4-50-K			50			100			1.11	51.66	53.39	-	-	-	○
SHM200-BN2-5-20-K	5	2.5	20	4	4.85	65	6	4	1.48	20.62	21.25	-	-	-	○
SHM200-BN2-5-25-K			25			70			1.18	25.79	26.6	-	-	-	●
SHM200-BN2-5-30-K			30			75			0.98	30.96	-	-	-	-	○
SHM200-BN2-5-40-K			40			80			0.73	41.29	-	-	-	-	○
SHM200-BN2-6-12-K	6	3	12	6	5.85	60	6	-	-	-	-	-	-	-	○
SHM200-BN2-6-20-K			20			65			-	-	-	-	-	○	
SHM200-BN2-6-30-K			30			75			-	-	-	-	-	○	
SHM200-BN2-6-50-K			50			100			-	-	-	-	-	●	

● Stock ○ Available upon Order

R	Tol
R ≤ 1.0	±0.003
R > 1.0	±0.005

Unit (mm)

Recommended Cutting Data ※ P626

Recommended Cutting Data

UP210- SS2/S2/SL2 /SH2/R2/RH2

Side Milling: Steel, Cast Iron



Workpiece		Cutting Depth (mm)	Vc m/min	Tool Diameter (mm)	3	4	6	8	10	12	16	20
P	Carbon Steel, Alloy Steel (<35HRC)	$ap \leq 1.5D$	180	$\frac{n}{(\min-1)}$	19110	14330	9550	7170	5730	4780	3580	2870
		$ae \leq 0.15D$		$\frac{Vf}{(\text{mm}/\text{min})}$	1070	1030	920	930	920	860	860	860
	Alloy Steel (35-48HRC)	$ap \leq 1D$	130	$\frac{n}{(\min-1)}$	13800	10350	6900	5180	4140	3450	2590	2070
		$ae \leq 0.12D$		$\frac{Vf}{(\text{mm}/\text{min})}$	610	580	550	620	560	500	410	370
M	Stainless Steel	$ap \leq 1.5D$	130	$\frac{n}{(\min-1)}$	13800	10350	6900	5180	4140	3450	2590	2070
		$ae \leq 0.15D$		$\frac{Vf}{(\text{mm}/\text{min})}$	690	660	590	650	610	590	490	460
K	Gray Cast Iron Nodular Cast Iron (<32HRC)	$ap \leq 1.5D$	160	$\frac{n}{(\min-1)}$	16990	12740	8490	6370	5100	4250	3190	2550
		$ae \leq 0.15D$		$\frac{Vf}{(\text{mm}/\text{min})}$	850	820	820	750	700	680	610	560
	High Alloy Cast Iron (35-45HRC)	$ap \leq 1D$	140	$\frac{n}{(\min-1)}$	14860	11150	7430	5570	4460	3720	2790	2230
		$ae \leq 0.12D$		$\frac{Vf}{(\text{mm}/\text{min})}$	650	670	670	620	580	560	500	460

UP210- S3

Side Milling: Steel, Cast Iron



Workpiece		Cutting Depth (mm)	Vc m/min	Tool Diameter (mm)	3	4	6	8	10	12	16	20
P	Carbon Steel, Alloy Steel (<35HRC)	$ap \leq 1.5D$	180	$\frac{n}{(\min-1)}$	19110	14330	9550	7170	5730	4780	3580	2870
		$ae \leq 0.15D$		$\frac{Vf}{(\text{mm}/\text{min})}$	1610	1550	1380	1400	1380	1290	1290	1290
	Alloy Steel (35-48HRC)	$ap \leq 1D$	130	$\frac{n}{(\min-1)}$	13800	10350	6900	5180	4140	3450	2590	2070
		$ae \leq 0.12D$		$\frac{Vf}{(\text{mm}/\text{min})}$	910	870	830	930	850	760	620	560
M	Stainless Steel	$ap \leq 1.5D$	130	$\frac{n}{(\min-1)}$	13800	10350	6900	5180	4140	3450	2590	2070
		$ae \leq 0.15D$		$\frac{Vf}{(\text{mm}/\text{min})}$	1040	990	890	980	920	880	740	680
K	Gray Cast Iron Nodular Cast Iron (<32HRC)	$ap \leq 1.5D$	160	$\frac{n}{(\min-1)}$	16990	12740	8490	6370	5100	4250	3190	2550
		$ae \leq 0.15D$		$\frac{Vf}{(\text{mm}/\text{min})}$	1270	1220	1220	1130	1060	1020	910	840
	High Alloy Cast Iron (35-45HRC)	$ap \leq 1D$	140	$\frac{n}{(\min-1)}$	14860	11150	7430	5570	4460	3720	2790	2230
		$ae \leq 0.12D$		$\frac{Vf}{(\text{mm}/\text{min})}$	980	1000	1000	940	870	840	750	680

【Note】

1. Use machine and holder with high rigidity .
2. Adjust the speed, feed and cutting depth according to actual cutting condition.
3. The milling conditions should be applied for the tool overhang length less than 4*D (mill dia).If the tool overhang length is too long, please adjust the speed, feed and cutting depth.

Recommended Cutting Data

UP210- SS4/S4/SC4/S4A/SL4 /SH4/R4/R4A/RH4

Side Milling: Steel, Cast Iron



Workpiece		Cutting Depth (mm)	Vc m/min	Tool Diameter (mm)	3	4	6	8	10	12	16	20
P	Carbon Steel, Alloy Steel (<35HRC)	$ap \leq 1.5D$	180	n (min-1)	19110	14330	9550	7170	5730	4780	3580	2870
		$ae \leq 0.15D$		V_f (mm/min)	2140	2060	1830	1860	1830	1720	1720	1720
	Alloy Steel (35-48HRC)	$ap \leq 1D$	130	n (min-1)	13800	10350	6900	5180	4140	3450	2590	2070
		$ae \leq 0.12D$		V_f (mm/min)	1210	1160	1100	1240	1130	1010	830	750
M	Stainless Steel	$ap \leq 1.5D$	130	n (min-1)	13800	10350	6900	5180	4140	3450	2590	2070
		$ae \leq 0.15D$		V_f (mm/min)	1380	1330	1190	1300	1230	1170	980	910
K	Gray Cast Iron Nodular Cast Iron (<32HRC)	$ap \leq 1.5D$	160	n (min-1)	16990	12740	8490	6370	5100	4250	3190	2550
		$ae \leq 0.15D$		V_f (mm/min)	1700	1630	1630	1500	1410	1360	1210	1120
	High Alloy Cast Iron (35-45HRC)	$ap \leq 1D$	140	n (min-1)	14860	11150	7430	5570	4460	3720	2790	2230
		$ae \leq 0.12D$		V_f (mm/min)	1310	1340	1340	1250	1160	1120	1000	910

UP210- S6

Side Milling: Steel, Cast Iron



Workpiece		Cutting Depth (mm)	Vc m/min	Tool Diameter (mm)	3	4	6	8	10	12	16	20
P	Carbon Steel, Alloy Steel (<35HRC)	$ap \leq 1.5D$	180	n (min-1)	19110	14330	9550	7170	5730	4780	3580	2870
		$ae \leq 0.15D$		V_f (mm/min)	3210	3100	2750	2800	2750	2580	2580	2580
	Alloy Steel (35-48HRC)	$ap \leq 1D$	130	n (min-1)	13800	10350	6900	5180	4140	3450	2590	2070
		$ae \leq 0.12D$		V_f (mm/min)	1820	1740	1660	1860	1690	1510	1240	1120
M	Stainless Steel	$ap \leq 1.5D$	130	n (min-1)	13800	10350	6900	5180	4140	3450	2590	2070
		$ae \leq 0.15D$		V_f (mm/min)	2070	1990	1780	1960	1840	1760	1480	1370
K	Gray Cast Iron Nodular Cast Iron (<32HRC)	$ap \leq 1.5D$	160	n (min-1)	16990	12740	8490	6370	5100	4250	3190	2550
		$ae \leq 0.15D$		V_f (mm/min)	2550	2450	2450	2260	2110	2040	1820	1680
	High Alloy Cast Iron (35-45HRC)	$ap \leq 1D$	140	n (min-1)	14860	11150	7430	5570	4460	3720	2790	2230
		$ae \leq 0.12D$		V_f (mm/min)	1960	2010	2010	1870	1740	1670	1510	1360

[Note]

1. Use machine and holder with high rigidity .
2. Adjust the speed, feed and cutting depth according to actual cutting condition.
3. The milling conditions should be applied for the tool overhang length less than $4 \cdot D$ (mill dia).If the tool overhang length is too long, please adjust the speed, feed and cutting depth.

Recommended Cutting Data

UP210- SS2/S2/SL2/SH2/R2/RH2

Slot Milling: Steel, Cast Iron



Workpiece		Cutting Depth (mm)	Vc m/min	Tool Diameter (mm)	3	4	6	8	10	12	16	20
P	Carbon Steel, Alloy Steel (<35HRC)	ap≤0.8D	80	n (min-1)	8490	6370	4250	3190	2550	2120	1590	1270
				Vf (mm/min)	430	540	440	400	370	350	400	410
	Alloy Steel (35-48HRC)	ap≤0.3D	60	n (min-1)	6370	4780	3190	2390	1910	1590	1190	960
				Vf (mm/min)	260	310	270	230	220	220	230	230
M	Stainless Steel	ap≤0.3D	55	n (min-1)	5840	4380	2920	2190	1750	1460	1100	880
				Vf (mm/min)	140	160	200	200	200	190	170	160
K	Gray Cast Iron Nodular Cast Iron (<32HRC)	ap≤0.5D	55	n (min-1)	5840	4380	2920	2190	1750	1460	1100	880
				Vf (mm/min)	210	250	250	220	210	200	190	170
	High Alloy Cast Iron (35-45HRC)	ap≤0.3D	50	n (min-1)	5310	3980	2650	1990	1590	1330	1000	800
				Vf (mm/min)	160	180	210	180	180	170	160	140

UP210- S3

Slot Milling: Steel, Cast Iron



Workpiece		Cutting Depth (mm)	Vc m/min	Tool Diameter (mm)	3	4	6	8	10	12	16	20
P	Carbon Steel, Alloy Steel (<35HRC)	ap≤0.8D	80	n (min-1)	8490	6370	4250	3190	2550	2120	1590	1270
				Vf (mm/min)	640	800	660	590	550	520	600	610
	Alloy Steel (35-48HRC)	ap≤0.3D	60	n (min-1)	6370	4780	3190	2390	1910	1590	1190	960
				Vf (mm/min)	380	460	400	340	330	330	340	340
M	Stainless Steel	ap≤0.3D	55	n (min-1)	5840	4380	2920	2190	1750	1460	1100	880
				Vf (mm/min)	210	240	310	300	290	290	260	240
K	Gray Cast Iron Nodular Cast Iron (<32HRC)	ap≤0.5D	55	n (min-1)	5840	4380	2920	2190	1750	1460	1100	880
				Vf (mm/min)	320	370	380	330	320	310	280	250
	High Alloy Cast Iron (35-45HRC)	ap≤0.3D	50	n (min-1)	5310	3980	2650	1990	1590	1330	1000	800
				Vf (mm/min)	240	280	320	270	260	260	240	220

[Note]

1. Use machine and holder with high rigidity .
2. Adjust the speed, feed and cutting depth according to actual cutting condition.
3. The milling conditions should be applied for the tool overhang length less than 4*D (mill dia).If the tool overhang length is too long, please adjust the speed, feed and cutting depth.

Recommended Cutting Data

UP210- B2/BH2

Profile Milling: Steel, Cast Iron



Workpiece		Cutting Depth (mm)	Vc m/min	Tool Diameter (mm)	4	5	6	7	8	9	10	11	12
P	Carbon Steel, Alloy Steel (<35HRC)	$ap \leq 0.2D$	160	$\frac{n}{(\min-1)}$	12740	10190	8490	7280	6370	5660	5100	4630	4250
		$ae \leq 0.3D$		$\frac{Vf}{(\text{mm}/\text{min})}$	1020	1020	1020	1020	1020	1020	1020	1020	1020
	Alloy Steel (35-48HRC)	$ap \leq 0.15D$	120	$\frac{n}{(\min-1)}$	9550	7640	6370	5460	4780	4250	3820	3470	3190
		$ae \leq 0.15D$		$\frac{Vf}{(\text{mm}/\text{min})}$	610	640	660	630	620	610	610	610	610
M	Stainless Steel	$ap \leq 0.2D$	110	$\frac{n}{(\min-1)}$	8760	7010	5840	5010	4380	3890	3500	3190	2920
		$ae \leq 0.2D$		$\frac{Vf}{(\text{mm}/\text{min})}$	610	630	640	630	630	620	630	640	640
K	Gray Cast Iron Nodular Cast Iron (<32HRC)	$ap \leq 0.2D$	140	$\frac{n}{(\min-1)}$	11150	8920	7430	6370	5570	4950	4460	4050	3720
		$ae \leq 0.2D$		$\frac{Vf}{(\text{mm}/\text{min})}$	780	800	820	800	800	790	800	810	820
	High Alloy Cast Iron (35-45HRC)	$ap \leq 0.1D$	120	$\frac{n}{(\min-1)}$	9550	7640	6370	5460	4780	4250	3820	3470	3190
		$ae \leq 0.1D$		$\frac{Vf}{(\text{mm}/\text{min})}$	610	640	660	660	670	650	650	660	670

UP210- B4

Profile Milling: Steel, Cast Iron



Workpiece		Cutting Depth (mm)	Vc m/min	Tool Diameter (mm)	4	5	6	7	8	9	10	11	12
P	Carbon Steel, Alloy Steel (<35HRC)	$ap \leq 0.2D$	160	$\frac{n}{(\min-1)}$	12740	10190	8490	7280	6370	5660	5100	4630	4250
		$ae \leq 0.3D$		$\frac{Vf}{(\text{mm}/\text{min})}$	2040	2040	2040	2040	2040	2040	2040	2040	2040
	Alloy Steel (35-48HRC)	$ap \leq 0.15D$	120	$\frac{n}{(\min-1)}$	9550	7640	6370	5460	4780	4250	3820	3470	3190
		$ae \leq 0.15D$		$\frac{Vf}{(\text{mm}/\text{min})}$	1220	1280	1330	1270	1240	1220	1220	1210	1210
M	Stainless Steel	$ap \leq 0.2D$	110	$\frac{n}{(\min-1)}$	8760	7010	5840	5010	4380	3890	3500	3190	2920
		$ae \leq 0.2D$		$\frac{Vf}{(\text{mm}/\text{min})}$	1230	1260	1290	1260	1260	1250	1260	1270	1290
K	Gray Cast Iron Nodular Cast Iron (<32HRC)	$ap \leq 0.2D$	140	$\frac{n}{(\min-1)}$	11150	8920	7430	6370	5570	4950	4460	4050	3720
		$ae \leq 0.2D$		$\frac{Vf}{(\text{mm}/\text{min})}$	1560	1610	1640	1610	1610	1590	1610	1620	1640
	High Alloy Cast Iron (35-45HRC)	$ap \leq 0.1D$	120	$\frac{n}{(\min-1)}$	9550	7640	6370	5460	4780	4250	3820	3470	3190
		$ae \leq 0.1D$		$\frac{Vf}{(\text{mm}/\text{min})}$	1220	1280	1330	1310	1340	1310	1300	1320	1340

[Note]

1. Use machine and holder with high rigidity .
2. Adjust the speed, feed and cutting depth according to actual cutting condition.
3. The milling conditions should be applied for the tool overhang length less than 4*D (mill dia).If the tool overhang length is too long, please adjust the speed, feed and cutting depth.

Recommended Cutting Data

UP210- L60/L90/L120

Chamfer Milling: Steel, Cast Iron



Workpiece		Vc m/min	Tool Diameter (mm)	4	6	8	10	12	16	20
P	Carbon Steel, Alloy Steel (<35HRC)	130	n (min-1)	10350	6900	5175	4140	3450	2588	2070
			V_f (mm/min)	414	33	311	414	442	435	406
	Alloy Steel (35-48HRC)	90	n (min-1)	7166	4777	3583	2866	2389	1791	1433
			V_f (mm/min)	229	191	172	172	239	229	241
M	Stainless Steel	80	n (min-1)	6369	4246	3185	2548	2123	1592	1274
			V_f (mm/min)	204	170	153	153	212	204	214
K	Gray Cast Iron Nodular Cast Iron (<32HRC)	100	n (min-1)	7962	5308	3981	3185	2654	1990	1592
			V_f (mm/min)	318	255	239	318	340	334	312
	High Alloy Cast Iron (35-45HRC)	150	n (min-1)	11943	7962	5971	4777	3981	2986	2389
			V_f (mm/min)	621	573	597	611	669	585	602

SP210- S3/C3

Side Milling: Steel, Cast Iron



Workpiece		Cutting Depth (mm)	Vc m/min	Tool Diameter (mm)	3	4	6	8	10	12	16	20
P	Carbon Steel, Alloy Steel (<35HRC)	$ap \leq 1.5D$	200	n (min-1)	21230	15920	10620	7960	6370	5310	3980	3190
		$ae \leq 0.15D$		V_f (mm/min)	2040	1960	1690	1670	1620	1590	1490	1480
	Alloy Steel (35-48HRC)	$ap \leq 1D$	150	n (min-1)	15920	11940	7960	5970	4780	3980	2990	2390
		$ae \leq 0.12D$		V_f (mm/min)	1290	1180	1080	1160	1050	930	760	680
M	Stainless Steel	$ap \leq 1.5D$	150	n (min-1)	15920	11940	7960	5970	4780	3980	2990	2390
		$ae \leq 0.15D$		V_f (mm/min)	1580	1330	1150	1220	1130	1080	900	820
K	Gray Cast Iron Nodular Cast Iron (<32HRC)	$ap \leq 1.5D$	170	n (min-1)	18050	13540	9020	6770	5410	4510	3380	2710
		$ae \leq 0.15D$		V_f (mm/min)	1620	1500	1440	1300	1200	1150	1020	930
	High Alloy Cast Iron (35-45HRC)	$ap \leq 1D$	150	n (min-1)	15920	11940	7960	5970	4780	3980	2990	2390
		$ae \leq 0.12D$		V_f (mm/min)	1290	1250	1190	1090	1000	960	850	770

[Note]

1. Use machine and holder with high rigidity .
2. Adjust the speed, feed and cutting depth according to actual cutting condition.
3. The milling conditions should be applied for the tool overhang length less than $4 \cdot D$ (mill dia).If the tool overhang length is too long, please adjust the speed, feed and cutting depth.

Recommended Cutting Data

SP210- C4/CN4/R4/RH4/S4

Side Milling: Steel, Cast Iron



Workpiece		Cutting Depth (mm)	Vc m/min	Tool Diameter (mm)	3	4	6	8	10	12	16	20
P	Carbon Steel, Alloy Steel (<35HRC)	$ap \leq 1.5D$	200	n (min-1)	21230	15920	10620	7960	6370	5310	3980	3190
		$ae \leq 0.15D$		V_f (mm/min)	2720	2610	2250	2230	2170	2120	1990	1980
	Alloy Steel (35-48HRC)	$ap \leq 1D$	150	n (min-1)	15920	11940	7960	5970	4780	3980	2990	2390
		$ae \leq 0.12D$		V_f (mm/min)	1720	1580	1430	1550	1400	1240	1020	910
M	Stainless Steel	$ap \leq 1.5D$	150	n (min-1)	15920	11940	7960	5970	4780	3980	2990	2390
		$ae \leq 0.15D$		V_f (mm/min)	2100	1770	1530	1620	1510	1430	1190	1100
K	Gray Cast Iron Nodular Cast Iron (<32HRC)	$ap \leq 1.5D$	170	n (min-1)	18050	13540	9020	6770	5410	4510	3380	2710
		$ae \leq 0.15D$		V_f (mm/min)	2170	2000	1910	1730	1600	1530	1350	1250
	High Alloy Cast Iron (35-45HRC)	$ap \leq 1D$	150	n (min-1)	15920	11940	7960	5970	4780	3980	2990	2390
		$ae \leq 0.12D$		V_f (mm/min)	1720	1670	1590	1460	1340	1270	1140	1020

SP210- S3/C3

Slot Milling: Steel, Cast Iron



Workpiece		Cutting Depth (mm)	Vc m/min	Tool Diameter (mm)	3	4	6	8	10	12	16	20
P	Carbon Steel, Alloy Steel (<35HRC)	$ap \leq 1D$	80	n (min-1)	8490	6370	4250	3190	2550	2120	1590	1270
				V_f (mm/min)	790	920	730	640	590	570	640	650
	Alloy Steel (35-48HRC)	$ap \leq 0.5D$	60	n (min-1)	6370	4780	3190	2390	1910	1590	1190	960
				V_f (mm/min)	500	550	450	370	360	360	370	370
M	Stainless Steel	$ap \leq 0.3D$	55	n (min-1)	5840	4380	2920	2190	1750	1460	1100	880
				V_f (mm/min)	320	320	350	340	320	320	280	260
K	Gray Cast Iron Nodular Cast Iron (<32HRC)	$ap \leq 0.8D$	55	n (min-1)	5840	4380	2920	2190	1750	1460	1100	880
				V_f (mm/min)	420	450	420	360	340	340	310	280
	High Alloy Cast Iron (35-45HRC)	$ap \leq 0.5D$	50	n (min-1)	5310	3980	2650	1990	1590	1330	1000	800
				V_f (mm/min)	330	350	360	300	290	290	260	240

[Note]

1. Use machine and holder with high rigidity .
2. Adjust the speed, feed and cutting depth according to actual cutting condition.
3. The milling conditions should be applied for the tool overhang length less than $4 \cdot D$ (mill dia).If the tool overhang length is too long, please adjust the speed, feed and cutting depth.

Recommended Cutting Data

SP210- C4/CN4/R4/RH4/S4

Slot Milling: Steel, Cast Iron



Workpiece		Cutting Depth (mm)	Vc m/min	Tool Diameter (mm)	3	4	6	8	10	12	16	20
P	Carbon Steel, Alloy Steel (<35HRC)	ap≤1D	80	n (min-1)	8490	6370	4250	3190	2550	2120	1590	1270
				Vf (mm/min)	1050	1220	970	850	790	760	850	870
M	Alloy Steel (35-48HRC)	ap≤0.5D	60	n (min-1)	6370	4780	3190	2390	1910	1590	1190	960
				Vf (mm/min)	660	730	600	500	470	480	490	500
M	Stainless Steel	ap≤0.3D	55	n (min-1)	5840	4380	2920	2190	1750	1460	1100	880
				Vf (mm/min)	420	420	470	450	430	430	380	350
K	Gray Cast Iron Nodular Cast Iron (<32HRC)	ap≤0.8D	55	n (min-1)	5840	4380	2920	2190	1750	1460	1100	880
				Vf (mm/min)	560	600	560	480	460	450	410	370
	High Alloy Cast Iron (35-45HRC)	ap≤0.5D	50	n (min-1)	5310	3980	2650	1990	1590	1330	1000	800
				Vf (mm/min)	450	460	480	400	380	380	350	320

SP210- B2/BH2

Profile Milling: Steel, Cast Iron



Workpiece		Cutting Depth (mm)	Vc m/min	Tool Diameter (mm)	1	2	3	4	6	8	10	12
P	Carbon Steel, Alloy Steel (<35HRC)	ap≤0.04D	220	n (min-1)	50000	35030	23360	17520	11680	8760	7010	5840
		ae≤0.04D		Vf (mm/min)	2800	2800	2800	2800	2800	2800	2800	2800
	Alloy Steel (35-48HRC)	ap≤0.02D	180	n (min-1)	50000	28660	19110	14330	9550	7170	5730	4780
		ae≤0.02D		Vf (mm/min)	1950	2010	1990	2010	2010	2010	2000	2000
M	Stainless Steel	ap≤0.04D	220	n (min-1)	50000	35030	23360	17520	11680	8760	7010	5840
		ae≤0.04D		Vf (mm/min)	2520	2450	2570	2630	2570	2540	2520	2530
K	Gray Cast Iron Nodular Cast Iron (<32HRC)	ap≤0.04D	220	n (min-1)	50000	35030	23360	17520	11680	8760	7010	5840
		ae≤0.04D		Vf (mm/min)	2520	2450	2570	2630	2570	2540	2520	2530
	High Alloy Cast Iron (35-45HRC)	ap≤0.04D	220	n (min-1)	50000	35030	23360	17520	11680	8760	7010	5840
		ae≤0.04D		Vf (mm/min)	2380	2450	2430	2450	2450	2450	2440	2440

【Note】

1. Use machine and holder with high rigidity .
2. Adjust the speed, feed and cutting depth according to actual cutting condition.
3. The milling conditions should be applied for the tool overhang length less than 4*D (mill dia) .If the tool overhang length is too long, please adjust the speed, feed and cutting depth.

Recommended Cutting Data

PP300- C2

Side Milling: Steel, Cast Iron



Workpiece		Cutting Depth (mm)	Vc m/min	Tool Diameter (mm)	3	4	6	8	10	12	16	20
P	Carbon Steel, Alloy Steel (<35HRC)	$ap \leq 1.5D$	200	$\frac{n}{(\min-1)}$	21220	15910	10610	7950	6370	5300	3980	3180
		$ae \leq 0.15D$		$\frac{Vf}{(\text{mm/min})}$	1910	1750	1380	1350	1270	1220	1110	1080
	Alloy Steel (35-48HRC)	$ap \leq 1D$	150	$\frac{n}{(\min-1)}$	15910	11940	7960	5970	4770	3980	2980	2390
		$ae \leq 0.12D$		$\frac{Vf}{(\text{mm/min})}$	1270	1070	950	950	810	720	600	520
M	Stainless Steel	$ap \leq 1.5D$	150	$\frac{n}{(\min-1)}$	15910	11940	7960	5970	4770	3980	2980	2390
		$ae \leq 0.15D$		$\frac{Vf}{(\text{mm/min})}$	1430	2390	1910	1910	1810	1670	1370	1240
K	Gray Cast Iron Nodular Cast Iron (<32HRC)	$ap \leq 1.5D$	180	$\frac{n}{(\min-1)}$	19100	14320	9550	7160	5730	4770	3580	2860
		$ae \leq 0.15D$		$\frac{Vf}{(\text{mm/min})}$	1720	1430	1240	1070	970	950	820	740
	High Alloy Cast Iron (35-45HRC)	$ap \leq 1D$	150	$\frac{n}{(\min-1)}$	15910	11940	7960	5970	4770	3980	2980	2390
		$ae \leq 0.12D$		$\frac{Vf}{(\text{mm/min})}$	1270	1190	1030	890	810	760	660	570

PP300- C2

Slot Milling: Steel, Cast Iron



Workpiece		Cutting Depth (mm)	Vc m/min	Tool Diameter (mm)	3	4	6	8	10	12	16	20
P	Carbon Steel, Alloy Steel (<35HRC)	$ap \leq 1.0D$	100	$\frac{n}{(\min-1)}$	10610	7960	5300	3980	3180	2650	1990	1590
				$\frac{Vf}{(\text{mm/min})}$	760	870	690	600	570	500	560	560
	Alloy Steel (35-48HRC)	$ap \leq 0.5D$	80	$\frac{n}{(\min-1)}$	8490	6370	4240	3180	2550	2120	1590	1270
				$\frac{Vf}{(\text{mm/min})}$	510	570	470	380	360	340	350	340
M	Stainless Steel	$ap \leq 0.3D$	70	$\frac{n}{(\min-1)}$	7430	5570	3710	2780	2230	1860	1390	1110
				$\frac{Vf}{(\text{mm/min})}$	370	330	330	310	290	300	250	230
K	Gray Cast Iron Nodular Cast Iron (<32HRC)	$ap \leq 0.8D$	80	$\frac{n}{(\min-1)}$	8490	6370	4240	3180	2550	2120	1590	1270
				$\frac{Vf}{(\text{mm/min})}$	510	510	470	380	370	350	320	280
	High Alloy Cast Iron (35-45HRC)	$ap \leq 0.5D$	70	$\frac{n}{(\min-1)}$	7430	5570	3710	2780	2230	1860	1390	1110
				$\frac{Vf}{(\text{mm/min})}$	390	390	370	310	290	280	260	230

[Note]

1. Use machine and holder with high rigidity .
2. Adjust the speed, feed and cutting depth according to actual cutting condition.
3. The milling conditions should be applied for the tool overhang length less than $4 \cdot D$ (mill dia).If the tool overhang length is too long, please adjust the speed, feed and cutting depth.

Recommended Cutting Data

PP300- C3

Side Milling: Steel, Cast Iron



Workpiece		Cutting Depth (mm)	Vc m/min	Tool Diameter (mm)	3	4	6	8	10	12	16	20
P	Carbon Steel, Alloy Steel (<35HRC)	$ap \leq 1.5D$	200	$\frac{n}{(\min-1)}$	21220	15910	10610	7950	6370	5300	3980	3180
		$ae \leq 0.15D$		$\frac{Vf}{(\text{mm}/\text{min})}$	2860	2630	2070	2030	1910	1830	1670	1620
	Alloy Steel (35-48HRC)	$ap \leq 1D$	150	$\frac{n}{(\min-1)}$	15910	11940	7960	5970	4770	3980	2980	2390
		$ae \leq 0.12D$		$\frac{Vf}{(\text{mm}/\text{min})}$	1910	1610	1430	1430	1220	1070	890	790
M	Stainless Steel	$ap \leq 1.5D$	150	$\frac{n}{(\min-1)}$	15910	11940	7960	5970	4770	3980	2980	2390
		$ae \leq 0.15D$		$\frac{Vf}{(\text{mm}/\text{min})}$	2150	1790	1430	1430	1360	1250	1030	930
K	Gray Cast Iron Nodular Cast Iron (<32HRC)	$ap \leq 1.5D$	180	$\frac{n}{(\min-1)}$	19100	14320	9550	7160	5730	4770	3580	2860
		$ae \leq 0.15D$		$\frac{Vf}{(\text{mm}/\text{min})}$	2580	2150	1860	1610	1460	1430	1230	1120
	High Alloy Cast Iron (35-45HRC)	$ap \leq 1D$	150	$\frac{n}{(\min-1)}$	15910	11940	7960	5970	4770	3980	2980	2390
		$ae \leq 0.12D$		$\frac{Vf}{(\text{mm}/\text{min})}$	1910	1790	1550	1340	1220	1130	980	860

PP300- C3

Slot Milling: Steel, Cast Iron



Workpiece		Cutting Depth (mm)	Vc m/min	Tool Diameter (mm)	3	4	6	8	10	12	16	20
P	Carbon Steel, Alloy Steel (<35HRC)	$ap \leq 1.0D$	100	$\frac{n}{(\min-1)}$	10610	7960	5300	3980	3180	2650	1990	1590
				$\frac{Vf}{(\text{mm}/\text{min})}$	1140	1310	1030	890	860	760	840	840
	Alloy Steel (35-48HRC)	$ap \leq 0.5D$	80	$\frac{n}{(\min-1)}$	8490	6370	4240	3180	2550	2120	1590	1270
				$\frac{Vf}{(\text{mm}/\text{min})}$	760	860	700	570	530	510	520	520
M	Stainless Steel	$ap \leq 0.3D$	70	$\frac{n}{(\min-1)}$	7430	5570	3710	2780	2230	1860	1390	1110
				$\frac{Vf}{(\text{mm}/\text{min})}$	560	500	500	470	440	450	380	350
K	Gray Cast Iron Nodular Cast Iron (<32HRC)	$ap \leq 0.8D$	80	$\frac{n}{(\min-1)}$	8490	6370	4240	3180	2550	2120	1590	1270
				$\frac{Vf}{(\text{mm}/\text{min})}$	760	760	700	570	550	530	480	420
	High Alloy Cast Iron (35-45HRC)	$ap \leq 0.5D$	70	$\frac{n}{(\min-1)}$	7430	5570	3710	2780	2230	1860	1390	1110
				$\frac{Vf}{(\text{mm}/\text{min})}$	580	580	560	460	430	420	400	350

【Note】

1. Use machine and holder with high rigidity .
2. Adjust the speed, feed and cutting depth according to actual cutting condition.
3. The milling conditions should be applied for the tool overhang length less than $4 * D$ (mill dia).If the tool overhang length is too long, please adjust the speed, feed and cutting depth.

Recommended Cutting Data

PP300- C4/R4

Side Milling: Steel, Cast Iron



Workpiece		Cutting Depth (mm)	Vc m/min	Tool Diameter (mm)	3	4	6	8	10	12	16	20
P	Carbon Steel, Alloy Steel (<35HRC)	$ap \leq 1.5D$	200	$\frac{n}{(\min-1)}$	21220	15910	10610	7950	6370	5300	3980	3180
		$ae \leq 0.15D$		Vf (mm/min)	3820	3500	2760	2710	2550	2440	2230	2160
	Alloy Steel (35-48HRC)	$ap \leq 1D$	150	$\frac{n}{(\min-1)}$	15910	11940	7960	5970	4770	3980	2980	2390
		$ae \leq 0.12D$		Vf (mm/min)	2550	2150	1910	1910	1620	1430	1190	1050
M	Stainless Steel	$ap \leq 1.5D$	150	$\frac{n}{(\min-1)}$	15910	11940	7960	5970	4770	3980	2980	2390
		$ae \leq 0.15D$		Vf (mm/min)	2860	2390	1910	1910	1810	1670	1370	1240
K	Gray Cast Iron Nodular Cast Iron (<32HRC)	$ap \leq 1.5D$	180	$\frac{n}{(\min-1)}$	19100	14320	9550	7160	5730	4770	3580	2860
		$ae \leq 0.15D$		Vf (mm/min)	3440	2860	2480	2150	1950	1910	1650	1490
	High Alloy Cast Iron (35-45HRC)	$ap \leq 1D$	150	$\frac{n}{(\min-1)}$	15910	11940	7960	5970	4770	3980	2980	2390
		$ae \leq 0.12D$		Vf (mm/min)	2550	2390	2070	1790	1620	1510	1310	1150

PP300- C4/R4

Slot Milling: Steel, Cast Iron



Workpiece		Cutting Depth (mm)	Vc m/min	Tool Diameter (mm)	3	4	6	8	10	12	16	20
P	Carbon Steel, Alloy Steel (<35HRC)	$ap \leq 1.0D$	100	$\frac{n}{(\min-1)}$	10610	7960	5300	3980	3180	2650	1990	1590
				Vf (mm/min)	1530	1750	1380	1190	1150	1010	1110	1120
	Alloy Steel (35-48HRC)	$ap \leq 0.5D$	80	$\frac{n}{(\min-1)}$	8490	6370	4240	3180	2550	2120	1590	1270
				Vf (mm/min)	1020	1150	930	760	710	680	700	690
M	Stainless Steel	$ap \leq 0.3D$	70	$\frac{n}{(\min-1)}$	7430	5570	3710	2780	2230	1860	1390	1110
				Vf (mm/min)	740	670	670	620	590	590	510	470
K	Gray Cast Iron Nodular Cast Iron (<32HRC)	$ap \leq 0.8D$	80	$\frac{n}{(\min-1)}$	8490	6370	4240	3180	2550	2120	1590	1270
				Vf (mm/min)	1020	1020	930	760	730	700	640	560
	High Alloy Cast Iron (35-45HRC)	$ap \leq 0.5D$	70	$\frac{n}{(\min-1)}$	7430	5570	3710	2780	2230	1860	1390	1110
				Vf (mm/min)	770	780	740	610	580	560	530	470

[Note]

1. Use machine and holder with high rigidity .
2. Adjust the speed, feed and cutting depth according to actual cutting condition.
3. The milling conditions should be applied for the tool overhang length less than $4 \cdot D$ (mill dia).If the tool overhang length is too long, please adjust the speed, feed and cutting depth.

Recommended Cutting Data

PP300-SPEED-3D/3DN

Side milling/Trochoidal milling: Steel, Cast Iron



Workpiece		Cutting Depth (mm)	Vc m/min	Tool Diameter (mm)	6	8	10	12	14	16	20
P	Carbon Steel, Alloy Steel (<35HRC)	$ap \leq 3D$	180	$\frac{n}{(\min-1)}$	9550	7160	5730	4770	4090	3580	2860
		$ae \leq 0.05D$		$\frac{Vf}{(\text{mm}/\text{min})}$	2290	2290	2860	2860	2860	2680	2140
	Alloy Steel (35-48HRC)	$ap \leq 3D$	110	$\frac{n}{(\min-1)}$	5830	4370	3500	2910	2500	2190	1750
		$ae \leq 0.05D$		$\frac{Vf}{(\text{mm}/\text{min})}$	1160	1040	1400	1450	1370	1420	1310
M	Stainless Steel	$ap \leq 3D$	110	$\frac{n}{(\min-1)}$	5830	4370	3500	2910	2500	2190	1750
		$ae \leq 0.05D$		$\frac{Vf}{(\text{mm}/\text{min})}$	1160	1040	1400	1450	1370	1420	1310
K	Gray Cast Iron Nodular Cast Iron (<32HRC)	$ap \leq 3D$	180	$\frac{n}{(\min-1)}$	9550	7160	5730	4770	4090	3580	2860
		$ae \leq 0.05D$		$\frac{Vf}{(\text{mm}/\text{min})}$	2290	2290	2860	2860	2860	2680	2140
	High Alloy Cast Iron (35-45HRC)	$ap \leq 3D$	110	$\frac{n}{(\min-1)}$	5830	4370	3500	2910	2500	2190	1750
		$ae \leq 0.05D$		$\frac{Vf}{(\text{mm}/\text{min})}$	1160	1040	1400	1450	1370	1420	1310

PP300-SPEED-5D

Side milling/Trochoidal milling: Steel, Cast Iron



Workpiece		Cutting Depth (mm)	Vc m/min	Tool Diameter (mm)	6	8	10	12	14	16	20
P	Carbon Steel, Alloy Steel (<35HRC)	$ap \leq 5D$	180	$\frac{n}{(\min-1)}$	9550	7160	5730	4770	4090	3580	2860
		$ae \leq 0.05D$		$\frac{Vf}{(\text{mm}/\text{min})}$	2290	2290	2860	2860	2860	2680	2140
	Alloy Steel (35-48HRC)	$ap \leq 5D$	110	$\frac{n}{(\min-1)}$	5830	4370	3500	2910	2500	2190	1750
		$ae \leq 0.05D$		$\frac{Vf}{(\text{mm}/\text{min})}$	1160	1040	1400	1450	1370	1420	1310
M	Stainless Steel	$ap \leq 5D$	110	$\frac{n}{(\min-1)}$	5830	4370	3500	2910	2500	2190	1750
		$ae \leq 0.05D$		$\frac{Vf}{(\text{mm}/\text{min})}$	1160	1040	1400	1450	1370	1420	1310
K	Gray Cast Iron Nodular Cast Iron (<32HRC)	$ap \leq 5D$	180	$\frac{n}{(\min-1)}$	9550	7160	5730	4770	4090	3580	2860
		$ae \leq 0.05D$		$\frac{Vf}{(\text{mm}/\text{min})}$	2290	2290	2860	2860	2860	2680	2140
	High Alloy Cast Iron (35-45HRC)	$ap \leq 5D$	110	$\frac{n}{(\min-1)}$	5830	4370	3500	2910	2500	2190	1750
		$ae \leq 0.05D$		$\frac{Vf}{(\text{mm}/\text{min})}$	1160	1040	1400	1450	1370	1420	1310

【Note】

1. Use machine and holder with high rigidity.
2. Adjust the speed, feed and cutting depth according to actual cutting condition.

Recommended Cutting Data

UPR210- S4

Side Milling: Steel, Cast Iron



Workpiece		Cutting Depth (mm)	Vc m/min	Tool Diameter (mm)	6	8	10	12	16	20
P	Carbon Steel, Alloy Steel (<35HRC)	$ap \leq 1.5D$	140	$\frac{n}{(\min-1)}$	7430	5570	4460	3720	2790	2230
		$ae \leq 0.3D$		$\frac{Vf}{(\text{mm}/\text{min})}$	1070	1070	1070	1070	1000	900
	Alloy Steel (35-48HRC)	$ap \leq 1D$	120	$\frac{n}{(\min-1)}$	6370	4780	3820	3190	2390	1910
		$ae \leq 0.25D$		$\frac{Vf}{(\text{mm}/\text{min})}$	630	660	690	700	570	535
M	Stainless Steel	$ap \leq 1.5D$	110	$\frac{n}{(\min-1)}$	5840	4380	3500	2920	2190	1750
		$ae \leq 0.3D$		$\frac{Vf}{(\text{mm}/\text{min})}$	580	610	630	640	525	490
K	Gray Cast Iron Nodular Cast Iron (<32HRC)	$ap \leq 1.5D$	140	$\frac{n}{(\min-1)}$	7430	5570	4460	3720	2790	2230
		$ae \leq 0.3D$		$\frac{Vf}{(\text{mm}/\text{min})}$	1070	1070	1070	1070	1000	900
	High Alloy Cast Iron (35-45HRC)	$ap \leq 1D$	120	$\frac{n}{(\min-1)}$	6370	4780	3820	3190	2390	1910
		$ae \leq 0.25D$		$\frac{Vf}{(\text{mm}/\text{min})}$	630	660	690	700	570	535
H	Alloy Steel Hardened Steel (<55HRC)	$ap \leq 1D$	100	$\frac{n}{(\min-1)}$	5300	3980	3190	2650	1990	1590
		$ae \leq 0.125D$		$\frac{Vf}{(\text{mm}/\text{min})}$	530	480	450	420	400	380

UPR210- S4

Slot Milling: Steel, Cast Iron



Workpiece		Cutting Depth (mm)	Vc m/min	Tool Diameter (mm)	6	8	10	12	16	20
P	Carbon Steel, Alloy Steel (<35HRC)	$ap \leq 1D$	120	$\frac{n}{(\min-1)}$	6370	4780	3820	3190	2390	1910
				$\frac{Vf}{(\text{mm}/\text{min})}$	640	630	610	640	570	535
	Alloy Steel (35-48HRC)	$ap \leq 0.75D$	100	$\frac{n}{(\min-1)}$	5310	4000	3190	2650	1990	1590
				$\frac{Vf}{(\text{mm}/\text{min})}$	430	400	450	425	360	320
M	Stainless Steel	$ap \leq 0.75D$	90	$\frac{n}{(\min-1)}$	4775	3580	2865	2385	1790	1432
				$\frac{Vf}{(\text{mm}/\text{min})}$	382	160	190	210	200	190
K	Gray Cast Iron Nodular Cast Iron (<32HRC)	$ap \leq 1D$	120	$\frac{n}{(\min-1)}$	6370	4780	3820	3190	2390	1910
				$\frac{Vf}{(\text{mm}/\text{min})}$	640	630	610	640	570	535
	High Alloy Cast Iron (35-45HRC)	$ap \leq 0.75D$	100	$\frac{n}{(\min-1)}$	5310	4000	3190	2650	1990	1590
				$\frac{Vf}{(\text{mm}/\text{min})}$	430	400	450	425	360	320

【Note】

1. Use machine and holder with high rigidity.
2. Adjust the speed, feed and cutting depth according to actual cutting condition.
3. The milling conditions should be applied for the tool overhang length less than $4 \cdot D$ (mill dia). If the tool overhang length is too long, please adjust the speed, feed and cutting depth.

Recommended Cutting Data

UPN210- S4

Side Milling: Steel, Cast Iron



Workpiece		Cutting Depth (mm)	Vc m/min	Tool Diameter (mm)	6	8	10	12	16	20
P	Carbon Steel, Alloy Steel (<35HRC)	$ap \leq 1.5D$	130	$\frac{n}{(\min-1)}$	6900	5180	4140	3450	2590	2070
		$ae \leq 0.3D$		$\frac{Vf}{(\text{mm}/\text{min})}$	990	990	990	990	930	830
	Alloy Steel (35-48HRC)	$ap \leq 1D$	110	$\frac{n}{(\min-1)}$	5840	4380	3500	2920	2190	1750
		$ae \leq 0.25D$		$\frac{Vf}{(\text{mm}/\text{min})}$	580	610	630	640	525	490
M	Stainless Steel	$ap \leq 1.5D$	130	$\frac{n}{(\min-1)}$	6900	5180	4140	3450	2590	2070
		$ae \leq 0.3D$		$\frac{Vf}{(\text{mm}/\text{min})}$	280	310	330	350	310	290
K	Gray Cast Iron Nodular Cast Iron (<32HRC)	$ap \leq 1.5D$	130	$\frac{n}{(\min-1)}$	6900	5180	4140	3450	2590	2070
		$ae \leq 0.3D$		$\frac{Vf}{(\text{mm}/\text{min})}$	990	990	990	990	930	830
	High Alloy Cast Iron (35-45HRC)	$ap \leq 1D$	110	$\frac{n}{(\min-1)}$	5840	4380	3500	2920	2190	1750
		$ae \leq 0.25D$		$\frac{Vf}{(\text{mm}/\text{min})}$	580	610	630	640	525	490
H	Alloy Steel Hardened Steel (<55HRC)	$ap \leq 1D$	90	$\frac{n}{(\min-1)}$	4780	3580	2870	2390	1790	1430
		$ae \leq 0.125D$		$\frac{Vf}{(\text{mm}/\text{min})}$	480	430	400	380	360	345

【Note】

1. Use machine and holder with high rigidity .
2. Adjust the speed, feed and cutting depth according to actual cutting condition.
3. The milling conditions should be applied for the tool overhang length less than $4 \cdot D$ (mill dia).If the tool overhang length is too long, please adjust the speed, feed and cutting depth.

Recommended Cutting Data

UPN210- S4

Slot Milling: Steel, Cast Iron



Workpiece		Cutting Depth (mm)	Vc m/min	Tool Diameter (mm)	6	8	10	12	16	20
P	Carbon Steel, Alloy Steel (<35HRC)	$ap \leq 0.8D$	120	n (min-1)	6370	4780	3820	3190	2390	1910
				Vf (mm/min)	640	630	610	640	570	535
	Alloy Steel (35-48HRC)	$ap \leq 0.5D$	100	n (min-1)	5310	4000	3190	2650	1990	1590
				Vf (mm/min)	430	400	450	425	360	320
M	Stainless Steel	$ap \leq 0.8D$	100	n (min-1)	5310	3980	3190	2655	1990	1600
				Vf (mm/min)	150	160	190	210	200	190
K	Gray Cast Iron Nodular Cast Iron (<32HRC)	$ap \leq 0.8D$	120	n (min-1)	6370	4780	3820	3190	2390	1910
				Vf (mm/min)	640	630	610	640	570	535
	High Alloy Cast Iron (35-45HRC)	$ap \leq 0.5D$	100	n (min-1)	5310	4000	3190	2650	1990	1590
				Vf (mm/min)	430	400	450	425	360	320

UPR300-S3/S4

Side Milling: Steel, Cast Iron



Workpiece		Cutting Depth (mm)	Vc m/min	Tool Diameter (mm)	6	8	10	12	16	20
P	Carbon Steel, Alloy Steel (<35HRC)	$ap \leq 1.5D$	160	n (min-1)	8490	6370	5090	4240	3180	2550
		$ae \leq 0.4D$		Vf (mm/min)	790	820	1040	1020	940	880
	Alloy Steel (35-48HRC)	$ap \leq 1.5D$	150	n (min-1)	7960	5970	4770	3980	2980	2390
		$ae \leq 0.3D$		Vf (mm/min)	670	680	880	840	780	720
M	Stainless Steel	$ap \leq 1.5D$	115	n (min-1)	6100	4580	3660	3050	2290	1830
		$ae \leq 0.4D$		Vf (mm/min)	570	590	750	730	680	630
K	Gray Cast Iron Nodular Cast Iron (<32HRC)	$ap \leq 1.5D$	150	n (min-1)	7960	5970	4770	3980	2980	2390
		$ae \leq 0.5D$		Vf (mm/min)	880	910	1170	1110	1030	930
	High Alloy Cast Iron (35-45HRC)	$ap \leq 1.5D$	130	n (min-1)	6900	5170	4140	3450	2590	2070
		$ae \leq 0.4D$		Vf (mm/min)	520	530	680	660	610	570
H	Alloy Steel Hardened Steel (<55HRC)	$ap \leq 1.5D$	140	n (min-1)	7430	5570	4460	3710	2790	2230
		$ae \leq 0.3D$		Vf (mm/min)	620	640	820	790	720	670

【Note】

1. Use machine and holder with high rigidity.
2. Adjust the speed, feed and cutting depth according to actual cutting condition.
3. The milling conditions should be applied for the tool overhang length less than $4 \cdot D$ (mill dia). If the tool overhang length is too long, please adjust the speed, feed and cutting depth.

Recommended Cutting Data

UPR300-S3/S4

Slot Milling: Steel, Cast Iron



Workpiece		Cutting Depth (mm)	Vc m/min	Tool Diameter (mm)	6	8	10	12	16	20
P	Carbon Steel, Alloy Steel (<35HRC)	$ap \leq 1D$	130	n (min-1)	6900	5175	4140	3450	2590	2070
				V_f (mm/min)	510	530	680	660	610	570
	Alloy Steel (35-48HRC)	$ap \leq 0.75D$	120	n (min-1)	6370	4780	3820	3185	2390	1910
				V_f (mm/min)	430	440	560	540	500	460
M	Stainless Steel	$ap \leq 0.75D$	90	n (min-1)	4780	3580	2870	2390	1790	1430
				V_f (mm/min)	360	370	470	460	430	395
K	Gray Cast Iron Nodular Cast Iron (<32HRC)	$ap \leq 1D$	120	n (min-1)	6370	4780	3820	3185	2390	1910
				V_f (mm/min)	570	590	750	710	660	595
	High Alloy Cast Iron (35-45HRC)	$ap \leq 1D$	100	n (min-1)	5310	3980	3185	2650	1990	1590
				V_f (mm/min)	320	325	420	410	375	350
H	Alloy Steel Hardened Steel (<55HRC)	$ap \leq 0.3D$	110	n (min-1)	5840	4380	3500	2920	2190	1750
				V_f (mm/min)	390	400	515	500	450	420

【Note】

- 1、 Use machine and holder with high rigidity .
- 2、 Adjust the speed, feed and cutting depth according to actual cutting condition.
- 3、 The milling conditions should be applied for the tool overhang length less than $4 \cdot D$ (mill dia).If the tool overhang length is too long, please adjust the speed, feed and cutting depth.

Recommended Cutting Data

US200-S2/R2

Side Milling: Stainless Steel



Workpiece		Cutting Depth (mm)	Vc m/min	Tool Diameter (mm)	1	2	4	6	8	10	12	16	20
M	Stainless Steel				$ap \leq 1D$	100 (80-120)	n (min-1)	25000	15900	7960	5300	3980	3180
		$ae \leq 0.1D$	V_f (mm/min)	220	254		340	340	365	330	300	245	230

US200-S2/R2

Slot Milling: Stainless Steel



Workpiece		Cutting Depth (mm)	Vc m/min	Tool Diameter (mm)	1	2	4	6	8	10	12	16	20
M	Stainless Steel				$ap \leq 0.1D$	45 (35-55)	n (min-1)	14330	7165	3580	2390	1790	1430
		$ae \leq 1D$	V_f (mm/min)	200	140		120	155	155	155	155	135	120

US200- R3

Side Milling: Stainless Steel



Workpiece		Cutting Depth (mm)	Vc m/min	Tool Diameter (mm)	1	2	4	6	8	10	12	16	20
M	Stainless Steel				$ap \leq 1D$	100 (80-120)	n (min-1)	25000	15900	7960	5300	3980	3180
		$ae \leq 0.1D$	V_f (mm/min)	525	480		525	510	550	500	450	370	340

US200-R3

Slot Milling: Stainless Steel



Workpiece		Cutting Depth (mm)	Vc m/min	Tool Diameter (mm)	1	2	4	6	8	10	12	16	20
M	Stainless Steel				$ap \leq 0.1D$	45 (35-55)	n (min-1)	14330	7165	3580	2390	1790	1430
		$ae \leq 1D$	V_f (mm/min)	300	215		180	235	235	230	230	200	180

[Note]

1. Use machine and holder with high rigidity .
2. Adjust the speed, feed and cutting depth according to actual cutting condition.
3. The milling conditions should be applied for the tool overhang length less than $4 \cdot D$ (mill dia).If the tool overhang length is too long, please adjust the speed, feed and cutting depth.

Recommended Cutting Data

US200-SS4/S4/SN4/R4

Side Milling: Stainless Steel



Workpiece		Cutting Depth (mm)	Vc m/min	Tool Diameter (mm)	1	2	4	6	8	10	12	16	20
M	Stainless Steel	$ap \leq 1D$	100 (80-120)	$\frac{n}{(\min-1)}$	25000	15900	7960	5300	3980	3180	2650	1990	1590
		$ae \leq 0.1D$		$\frac{Vf}{(\text{mm}/\text{min})}$	700	635	700	680	730	660	600	490	460

US200-R4

Slot Milling: Stainless Steel



Workpiece		Cutting Depth (mm)	Vc m/min	Tool Diameter (mm)	1	2	4	6	8	10	12	16	20
M	Stainless Steel	$ap \leq 0.1D$	45 (35-55)	$\frac{n}{(\min-1)}$	14330	7165	3580	2390	1790	1430	1195	895	715
		$ae \leq 1D$		$\frac{Vf}{(\text{mm}/\text{min})}$	400	280	240	310	310	310	310	270	240

US200- B2

Profile Milling: Stainless Steel



Workpiece		Cutting Depth (mm)	Vc m/min	Tool Diameter (mm)	1	2	4	6	8	10	12	16	20
M	Stainless Steel	$ap \leq 0.2D$	100 (80-120)	$\frac{n}{(\min-1)}$	25000	15900	7960	5300	3980	3180	2650	1990	1590
		$ae \leq 0.2D$		$\frac{Vf}{(\text{mm}/\text{min})}$	525	480	510	550	560	540	560	520	510

US200-B4

Profile Milling: Stainless Steel



Workpiece		Cutting Depth (mm)	Vc m/min	Tool Diameter (mm)	1	2	4	6	8	10	12	16	20
M	Stainless Steel	$ap \leq 0.2D$	100 (80-120)	$\frac{n}{(\min-1)}$	25000	15900	7960	5300	3980	3180	2650	1990	1590
		$ae \leq 0.2D$		$\frac{Vf}{(\text{mm}/\text{min})}$	560	955	1020	1100	1110	1080	1115	1030	1020

[Note]

1. Use machine and holder with high rigidity .
2. Adjust the speed, feed and cutting depth according to actual cutting condition.
3. The milling conditions should be applied for the tool overhang length less than $4 \cdot D$ (mill dia).If the tool overhang length is too long, please adjust the speed, feed and cutting depth.

Recommended Cutting Data

US260-S2

Side Milling: Stainless Steel



Workpiece		Cutting Depth (mm)	Vc m/min	Tool Diameter (mm)	0.5	0.8	1	1.5	2	3	4	6	8
M	Stainless Steel				$ap \leq 1D$	25 -150	n (min-1)	18000	15000	13000	11000	10000	9500
		$ae \leq 0.1D$	V_f (mm/min)	500	800		1000	1200	1500	1800	2200	2500	2800

US260-S2

Face Milling: Stainless Steel



Workpiece		Cutting Depth (mm)	Vc m/min	Tool Diameter (mm)	0.5	0.8	1	1.5	2	3	4	6	8
M	Stainless Steel				$ap \leq 0.1D$	25 -150	n (min-1)	18000	15000	13000	11000	10000	9500
		$ae \leq 1D$	V_f (mm/min)	400	700		900	1100	1400	1700	2100	2200	2500

US260-SS4A/SS4B、S4A/S4B

Side Milling: Stainless Steel



Workpiece		Cutting Depth (mm)	Vc m/min	Tool Diameter (mm)	1	1.5	2	3	4	6	8	10	12
M	Stainless Steel				$ap \leq 1D$	40 -180	n (min-1)	13000	11000	10000	9500	9000	8000
		$ae \leq 0.1D$	V_f (mm/min)	1400	1700		2200	2700	3000	3500	3800	4000	4200

US260-SS4A/SS4B、S4A/S4B

Face Milling: Stainless Steel



Workpiece		Cutting Depth (mm)	Vc m/min	Tool Diameter (mm)	1	1.5	2	3	4	6	8	10	12
M	Stainless Steel				$ap \leq 0.1D$	40 -180	n (min-1)	13000	11000	10000	9500	9000	8000
		$ae \leq 1D$	V_f (mm/min)	1300	1600		2100	2600	2800	3200	3500	3800	4000

【Note】

1. Use machine and holder with high rigidity .
2. Adjust the speed, feed and cutting depth according to actual cutting condition.
3. The milling conditions should be applied for the tool overhang length less than $4 \cdot D$ (mill dia).If the tool overhang length is too long, please adjust the speed, feed and cutting depth.

Recommended Cutting Data

US260-R4/RS4

Side Milling: Stainless Steel



Workpiece		Cutting Depth (mm)	Vc m/min	Tool Diameter (mm)	1	1.5	2	3	4	6	8	10	12
M	Stainless Steel	$ap \leq 1D$	40 -180	n (min-1)	13000	11000	10000	9500	9000	8000	6000	5000	4500
		$ae \leq 0.1D$		V_f (mm/min)	1500	1800	2400	3000	3200	3600	3800	4000	4200

US260-R4/RS4

Face Milling: Stainless Steel



Workpiece		Cutting Depth (mm)	Vc m/min	Tool Diameter (mm)	1	1.5	2	3	4	6	8	10	12
M	Stainless Steel	$ap \leq 0.1D$	40 -180	n (min-1)	13000	11000	10000	9500	9000	8000	6000	5000	4500
		$ae \leq 1D$		V_f (mm/min)	1500	1800	2400	3000	3200	3600	3800	4000	4200

[Note]

1. Use machine and holder with high rigidity .
2. Adjust the speed, feed and cutting depth according to actual cutting condition.
3. The milling conditions should be applied for the tool overhang length less than $4 \cdot D$ (mill dia).If the tool overhang length is too long, please adjust the speed, feed and cutting depth.

Recommended Cutting Data

SS600-SS4/S4/SH4/RS4/R4/RH4

Side Milling: High Strength Steel



Workpiece		Cutting Depth (mm)	Vc m/min	Tool Diameter (mm)	2	3	4	5	6	8	10	12	16	20
M	Stainless Steel	$ap \leq 1.5D$	80 (60~110)	$\frac{n}{(\text{min}-1)}$	10000	7430	6730	5095	4245	3185	2545	2020	1590	1275
		$ae \leq 0.25D$		$\frac{Vf}{(\text{mm}/\text{min})}$	700	595	510	510	510	510	510	485	445	430
S	Titanium Alloys	$ap \leq 1.5D$	60 (40~100)	$\frac{n}{(\text{min}-1)}$	7960	6369	4780	3821	3185	2390	1910	1590	1195	955
		$ae \leq 0.25D$		$\frac{Vf}{(\text{mm}/\text{min})}$	398	350	285	270	320	335	354	350	310	305

SS600-SS4/S4/SH4/RS4/R4/RH4

Slot Milling: High Strength Steel



Workpiece		Cutting Depth (mm)	Vc m/min	Tool Diameter (mm)	2	3	4	5	6	8	10	12	16	20
M	Stainless Steel	$ap \leq 1.5D$	60 (50~70)	$\frac{n}{(\text{min}-1)}$	7960	6369	4775	3821	3185	2390	1910	1590	1195	955
		$ae \leq 0.25D$		$\frac{Vf}{(\text{mm}/\text{min})}$	398	350	285	270	320	335	345	350	310	305
S	Titanium Alloys	$ap \leq 1.5D$	40 (30~60)	$\frac{n}{(\text{min}-1)}$	6369	4246	3185	2550	2120	1590	1270	1060	792	635
		$ae \leq 0.25D$		$\frac{Vf}{(\text{mm}/\text{min})}$	254	241	190	190	190	190	200	210	190	190

SS600-B4

Profile Milling: High Strength Steel



Workpiece		Cutting Depth (mm)	Vc m/min	Tool Diameter (mm)	6	8	10	12	16	20
M	Stainless Steel	$ap \leq 0.2D$	100 (80~120)	$\frac{n}{(\text{min}-1)}$	5300	3980	3180	2650	1990	1590
		$ae \leq 0.2D$		$\frac{Vf}{(\text{mm}/\text{min})}$	1100	1100	1080	1050	1030	1020
S	Titanium Alloys	$ap \leq 0.2D$	70 (60~80)	$\frac{n}{(\text{min}-1)}$	3715	2785	2230	1860	1390	1110
		$ae \leq 0.2D$		$\frac{Vf}{(\text{mm}/\text{min})}$	670	610	535	480	445	352

SS600-S5/R5

Side Milling: High Strength Steel



Workpiece		Cutting Depth (mm)	Vc m/min	Tool Diameter (mm)	6	8	10	12	16	20	25
M	Stainless Steel	$ap \leq 1.5D$	80 (60~110)	$\frac{n}{(\text{min}-1)}$	4245	3185	2545	2020	1590	1275	1019
		$ae \leq 0.25D$		$\frac{Vf}{(\text{mm}/\text{min})}$	638	638	638	600	556	535	427
S	Titanium Alloys	$ap \leq 1.5D$	60 (40~100)	$\frac{n}{(\text{min}-1)}$	3185	2390	1910	1590	1195	955	764
		$ae \leq 0.25D$		$\frac{Vf}{(\text{mm}/\text{min})}$	400	418	432	437	387	381	305

[Note]

1. Use machine and holder with high rigidity.
2. Adjust the speed, feed and cutting depth according to actual cutting condition.
3. The milling conditions should be applied for the tool overhang length less than $4 \cdot D$ (mill dia). If the tool overhang length is too long, please adjust the speed, feed and cutting depth.

Recommended Cutting Data

UA100-S2/SH2/R2/RH2

Side Milling: Aluminium Alloys



Workpiece		Cutting Depth (mm)	Vc m/min	Tool Diameter (mm)	1	2	4	6	8	10	12	16	20
N	Wrought Aluminum Alloys Cast Aluminum Alloys (Si<12%)	$ap \leq 1.5D$	150 (60-350)	n (min-1)	16000	12700	12000	10600	10000	9500	9280	7000	5600
		$ae \leq 0.2D$		V_f (mm/min)	580	710	1200	1280	1390	1720	2400	2500	2450
	Copper Alloy (<HB200)	$ap \leq 1.5D$	150 (60-350)	n (min-1)	16000	12700	12000	10600	10000	9500	9280	7000	5600
		$ae \leq 0.2D$		V_f (mm/min)	520	650	1070	1150	1250	1550	2170	2250	2200

UA100-S2/SH2/R2/RH2

Slot Milling: Aluminium Alloys



Workpiece		Cutting Depth (mm)	Vc m/min	Tool Diameter (mm)	1	2	4	6	8	10	12	16	20
N	Wrought Aluminum Alloys Cast Aluminum Alloys (Si<12%)	$ap \leq 0.5D$	150 (60-350)	n (min-1)	16000	10000	9000	8000	7800	8000	6800	5000	4000
		$ae = 1D$		V_f (mm/min)	400	500	810	920	1100	1280	1300	1310	1200
	Copper Alloy (<HB200)	$ap \leq 0.5D$	150 (60-350)	n (min-1)	16000	10000	9000	8000	7800	8000	6800	5000	4000
		$ae = 1D$		V_f (mm/min)	380	450	800	830	1000	1150	1130	1000	1080

UA100-SL2

Side Milling: Aluminium Alloys



Workpiece		Cutting Depth (mm)	Vc m/min	Tool Diameter (mm)	1	2	4	6	8	10	12	16	20
N	Wrought Aluminum Alloys Cast Aluminum Alloys (Si<12%)	$ap \leq 2.5D$	150 (60-350)	n (min-1)	16000	10000	9000	8000	7800	8000	6800	5000	4000
		$ae \leq 0.15D$		V_f (mm/min)	400	500	810	920	1100	1280	1300	1310	1200
	Copper Alloy (<HB200)	$ap \leq 2.5D$	150 (60-350)	n (min-1)	16000	10000	9000	8000	7800	8000	6800	5000	4000
		$ae \leq 0.15D$		V_f (mm/min)	380	450	800	830	1000	1150	1130	1000	1080

【Note】

1. Use machine and holder with high rigidity .
2. Adjust the speed, feed and cutting depth according to actual cutting condition.
3. The milling conditions should be applied for the tool overhang length less than $4 \cdot D$ (mill dia).If the tool overhang length is too long, please adjust the speed, feed and cutting depth.

Recommended Cutting Data

UA100-S3/SH3/R3/RH3

Side Milling: Aluminium Alloys



Workpiece		Cutting Depth (mm)	Vc m/min	Tool Diameter (mm)	1	2	4	6	8	10	12	16	20
N	Wrought Aluminum Alloys Cast Aluminum Alloys (Si<12%)	$ap \leq 1.5D$	150 (60-350)	n (min-1)	16000	13000	12000	10600	10000	9500	9280	7000	5600
		$ae \leq 0.2D$		V_f (mm/min)	650	850	1430	1530	1670	2050	2800	3000	3150
	Copper Alloy (<HB200)	$ap \leq 1.5D$	150 (60-350)	n (min-1)	16000	13000	12000	10600	10000	9500	9280	7000	5600
		$ae \leq 0.2D$		V_f (mm/min)	720	900	1200	1200	1500	1800	2225	2500	3000

UA100-S3/SH3/R3/RH3

Slot Milling: Aluminium Alloys



Workpiece		Cutting Depth (mm)	Vc m/min	Tool Diameter (mm)	1	2	4	6	8	10	12	16	20
N	Wrought Aluminum Alloys Cast Aluminum Alloys (Si<12%)	$ap \leq 0.5D$	150 (60-350)	n (min-1)	16000	10000	9000	8000	7800	8000	6800	5000	4000
		$ae = 1D$		V_f (mm/min)	450	570	960	1050	1300	1500	1620	1680	1800
	Copper Alloy (<HB200)	$ap \leq 0.5D$	150 (60-350)	n (min-1)	16000	10000	9000	8000	7800	8000	6800	5000	4000
		$ae = 1D$		V_f (mm/min)	450	520	860	830	960	1240	1500	1550	1510

UA100- SL3

Side Milling: Aluminium Alloys



Workpiece		Cutting Depth (mm)	Vc m/min	Tool Diameter (mm)	1	2	4	6	8	10	12	16	20
N	Wrought Aluminum Alloys Cast Aluminum Alloys (Si<12%)	$ap \leq 2.5D$	150 (60-350)	n (min-1)	16000	10000	9000	8000	7800	8000	6800	5000	4000
		$ae \leq 0.15D$		V_f (mm/min)	450	570	960	1050	1300	1500	1620	1680	1800
	Copper Alloy (<HB200)	$ap \leq 2.5D$	150 (60-350)	n (min-1)	16000	10000	9000	8000	7800	8000	6800	5000	4000
		$ae \leq 0.15D$		V_f (mm/min)	450	520	860	830	960	1240	1500	1550	1510

[Note]

1. Use machine and holder with high rigidity .
2. Adjust the speed, feed and cutting depth according to actual cutting condition.
3. The milling conditions should be applied for the tool overhang length less than $4 \cdot D$ (mill dia) .If the tool overhang length is too long, please adjust the speed, feed and cutting depth.

Recommended Cutting Data

UA100-B2

Profile Milling : Aluminium Alloys



Workpiece		Cutting Depth (mm)	Vc m/min	Tool Diameter (mm)	1	2	4	6	8	10	12	16
N	Wrought Aluminum Alloys Cast Aluminum Alloys (Si<12%)	ap≤0.3D	150 (60-350)	n (min-1)	19000	15900	11900	10600	8000	7950	7950	7000
		ae≤0.3D		Vf (mm/min)	950	1600	1900	2500	2550	3200	3800	4450
	Copper Alloy (<HB200)	ap≤0.3D	150 (60-350)	n (min-1)	19000	15900	11900	10600	8000	7950	7950	7000
		ae≤0.3D		Vf (mm/min)	860	1430	1720	2300	2300	2850	3450	4010

SA100-S3

Side Milling: Aluminium Alloys



Workpiece		Cutting Depth (mm)	Vc m/min	Tool Diameter (mm)	2	4	6	8	10	12
N	Wrought Aluminum Alloys Cast Aluminum Alloys (Si<12%)	ap≤1.5D	150 (60-350)	n (min-1)	14000	12000	10000	9000	8500	8000
		ae≤0.2D		Vf (mm/min)	2000	3000	3500	4000	4500	5000
	Copper Alloy (<HB200)	ap≤1.5D	150 (60-350)	n (min-1)	14000	12000	10000	9000	8500	8000
		ae≤0.2D		Vf (mm/min)	2000	3000	3500	4000	4500	5000

SA100-S3

Slot Milling: Aluminium Alloys



Workpiece		Cutting Depth (mm)	Vc m/min	Tool Diameter (mm)	2	4	6	8	10	12
N	Wrought Aluminum Alloys Cast Aluminum Alloys (Si<12%)	ap≤1D	150 (60-350)	n (min-1)	11500	10000	9300	8750	8000	7450
		ae=1D		Vf (mm/min)	1000	1500	2000	2500	3500	4000
	Copper Alloy (<HB200)	ap≤1D	150 (60-350)	n (min-1)	11500	10000	9300	8750	8000	7450
		ae=1D		Vf (mm/min)	1000	1500	2000	2500	3500	4000

SA160-S3/SL3/S4/SS4

Side Milling: Aluminium Alloys



Workpiece		Cutting Depth (mm)	Vc m/min	Tool Diameter (mm)	4	6	8	10	12	16	20
N	Aluminium Alloys	ap≤2D	60-240	n (min-1)	12000	11000	10000	10000	9000	8000	6000
		ae≤0.1		Vf (mm/min)	600	800	800	1000	1200	1300	1500

【Note】

1. Use machine and holder with high rigidity .
2. Adjust the speed, feed and cutting depth according to actual cutting condition.
3. The milling conditions should be applied for the tool overhang length less than 4*D (mill dia).If the tool overhang length is too long, please adjust the speed, feed and cutting depth.

Recommended Cutting Data

SA210-WR/WR-IC

Side Milling: Aluminium Alloys



Workpiece		Cutting Depth (mm)	Vc m/min	Tool Diameter (mm)	12	16	20	25
N	Aluminium Alloys	$ap \leq 1D$	500~1750	$\frac{n}{(min-1)}$	14000	17000	20000	22000
		$ae \leq 0.7D$		$\frac{Vf}{(mm/min)}$	6300	7650	9000	9900

SA210-WR/WR-IC

Slot Milling: Aluminium Alloys



Workpiece		Cutting Depth (mm)	Vc m/min	Tool Diameter (mm)	12	16	20	25
N	Aluminium Alloys	$ap \leq 0.75D$	500~1750	$\frac{n}{(min-1)}$	14000	17000	20000	22000
		$Ae=1D$		$\frac{Vf}{(mm/min)}$	4200	5100	6000	6600

SA210-NR

Side Milling: Aluminium Alloys



Workpiece		Cutting Depth (mm)	Vc m/min	Tool Diameter (mm)	6	8	10	12	16	20
N	Aluminium Alloys	$ap \leq 2D$	300~400	$\frac{n}{(min-1)}$	18000	14000	1100	9000	7000	5500
		$ae \leq 0.5D$		$\frac{Vf}{(mm/min)}$	4700	4500	4300	3900	3500	3000

SA210-NR

Slot Milling: Aluminium Alloys



Workpiece		Cutting Depth (mm)	Vc m/min	Tool Diameter (mm)	6	8	10	12	16	20
N	Aluminium Alloys	$ap \leq 1.5D$	250~350	$\frac{n}{(min-1)}$	16000	1200	9500	7900	6000	4800
		$ae \leq 1D$		$\frac{Vf}{(mm/min)}$	2800	2800	2800	2800	2600	2400

【Note】

1. Use machine and holder with high rigidity.
2. Adjust the speed, feed and cutting depth according to actual cutting condition.
3. The milling conditions should be applied for the tool overhang length less than $3 \cdot D$ (mill dia). If the tool overhang length is too long, please adjust the speed, feed and cutting depth.

Recommended Cutting Data

SA300-RN2

Side Milling : Aluminium Alloys



Workpiece		Cutting Depth (mm)	Vc m/min	Tool Diameter (mm)	6	8	10	12	16	20	25	32
N	Aluminium Alloys 7075, 7050	$ap \leq 0.15D$	835 (370~1300)	$\frac{n}{(min-1)}$	20000	20000	20000	20000	20000	20000	16000	12000
		$ae \leq 0.5D$		$\frac{Vf}{(mm/min)}$	3200	4000	5200	6000	6600	6800	7560	4800

SA300-RN2

Slot Milling : Aluminium Alloys



Workpiece		Cutting Depth (mm)	Vc m/min	Tool Diameter (mm)	6	8	10	12	16	20	25	32
N	Aluminium Alloys 7075, 7050	$ap \leq 0.2D$	385 (300~471)	$\frac{n}{(min-1)}$	16000	15000	12000	10000	8000	7000	6000	4000
		$ae = 1D$		$\frac{Vf}{(mm/min)}$	3200	3600	3360	3200	3040	2940	3000	2000

SA300-S3/RN3

Side Milling : Aluminium Alloys



Workpiece		Cutting Depth (mm)	Vc m/min	Tool Diameter (mm)	6	8	10	12	16	20	25	32
N	Aluminium Alloys 7075, 7050	$ap \leq 0.25D$	785 (370~1200)	$\frac{n}{(min-1)}$	20000	20000	20000	20000	20000	20000	16000	12000
		$ae \leq 0.5D$		$\frac{Vf}{(mm/min)}$	4800	6000	7200	8400	9000	9000	10000	10800

SA300-S3/RN3

Slot Milling : Aluminium Alloys



Workpiece		Cutting Depth (mm)	Vc m/min	Tool Diameter (mm)	6	8	10	12	16	20	25	32
N	Aluminium Alloys 7075, 7050	$ap \leq 0.2D$	400 (300~500)	$\frac{n}{(min-1)}$	16000	15000	12000	10000	8000	7000	6000	4000
		$ae = 1D$		$\frac{Vf}{(mm/min)}$	4800	5400	5040	4800	4560	4410	4500	3000

SA300-BN2

Profile Milling : Aluminium Alloys



Workpiece		Cutting Depth (mm)	Vc m/min	Tool Diameter (mm)	6	8	10	12	16	20
N	Aluminium Alloys 7075, 7050	$ap \leq 0.75D$	550 (500~600)	$\frac{n}{(min-1)}$	25000	20000	20000	15000	11000	9000
		$Ae < 0.5D$		$\frac{Vf}{(mm/min)}$	4000	3500	3000	2500	2000	2000

【Note】

1. When the milling cutter is clamped, the maximum T.I.R. should be controlled below 0.005mm.
2. Please pay attention to use machine and holder with high rigidity.
3. Please adjust the speed, feed and cutting depth according to actual cutting conditions.
4. The milling conditions should be applied for the tool overhang length less than 3^*D (mill dia). If the tool overhang length is too long, please adjust the speed, feed and cutting depth.

Recommended Cutting Data

SA300-SF/SF-IC

Side Milling: Aluminium Alloys



Workpiece	Cutting Depth (mm)	Vc m/min	Tool Diameter (mm)	6	8	10	12	16	20
N Aluminium Alloys	$ap \leq 4D$	200~1150	$\frac{n}{(\text{min}-1)}$	12000	13000	14000	16000	17000	18000
	$ae \leq 0.5$		$\frac{Vf}{(\text{mm}/\text{min})}$	2880	3120	3360	3840	4080	4320

SA300-WF/WF-IC

Side Milling: Aluminium Alloys



Workpiece	Cutting Depth (mm)	Vc m/min	Tool Diameter (mm)	16	20	25
N Aluminium Alloys	$ap \leq 2$	850~1750	$\frac{n}{(\text{min}-1)}$	17000	20000	22000
	$ae \leq 0.7D$		$\frac{Vf}{(\text{mm}/\text{min})}$	10200	12000	13200

【Note】

- When the milling cutter is clamped, the maximum T.I.R. should be controlled below 0.005mm.
- Please pay attention to use machine and holder with high rigidity .
- Please adjust the speed, feed and cutting depth according to actual cutting conditions.
- The milling conditions should be applied for the tool overhang length less than $3 \cdot D$ (mill dia).If the tool overhang length is too long, please adjust the speed, feed and cutting depth.

DNM100-RS 1/RS2/ RS3

Side Milling : Compound Material、Aluminium Alloys



Workpiece	Cutting Depth (mm)	Vc m/min	Tool Diameter (mm)	2	4	6	8	10	12	16
N Compound Material	$ap \leq 1.5D$	400 (100~450)	$\frac{n}{(\text{min}-1)}$	18000	16000	13270	11775	11145	10615	8000
	$ae \leq 0.2D$		$\frac{Vf}{(\text{mm}/\text{min})}$	1800	2400	2650	2350	2230	2120	2400
Aluminium Alloys	$ap \leq 1.5D$	150 (100~250)	$\frac{n}{(\text{min}-1)}$	16000	12000	12000	10000	8000	8000	5000
	$ae \leq 0.1D$		$\frac{Vf}{(\text{mm}/\text{min})}$	2000	2000	2400	2000	1600	1600	1500

DNM100-RS1/RS2/ RS3

Face Milling : Compound Material、Aluminium Alloys



Workpiece	Cutting Depth (mm)	Vc m/min	Tool Diameter (mm)	2	4	6	8	10	12	16
N Compound Material	$ap \leq 0.1D$	400 (100~450)	$\frac{n}{(\text{min}-1)}$	18000	16000	13270	11775	11145	10615	8000
	$ae \leq 0.6D$		$\frac{Vf}{(\text{mm}/\text{min})}$	1800	2400	2650	2350	2230	2120	2400
Aluminium Alloys	$ap \leq 0.1D$	150 (100~250)	$\frac{n}{(\text{min}-1)}$	16000	12000	12000	10000	8000	8000	5000
	$ae \leq 0.6D$		$\frac{Vf}{(\text{mm}/\text{min})}$	2000	2000	2400	2000	1600	1600	1500

【Note】

- Use machine and holder with high rigidity .
- Adjust the speed, feed and cutting depth according to actual cutting condition.
- The milling conditions should be applied for the tool overhang length less than $4 \cdot D$ (mill dia).If the tool overhang length is too long, please adjust the speed, feed and cutting depth.

Recommended Cutting Data

SG200- S2/SN2/R2/RN2

Side Milling :Graphite



Workpiece		Cutting Depth (mm)	Vc m/min	Tool Diameter (mm)	2	4	6	8	10	12
N	For High silicon Aluminum (Si>12%)	ap≤1D	200	n (min-1)	31850	15920	10620	7960	6370	5310
		ae≤0.15D		V_f (mm/min)	1910	1590	1270	1120	1080	1380
	Graphite	ap≤1.5D	250	n (min-1)	39810	19900	13270	9950	7960	6640
		ae≤0.5D		V_f (mm/min)	3980	2790	2390	2190	2390	2390

SG200-S3

Side Milling :Graphite



Workpiece		Cutting Depth (mm)	Vc m/min	Tool Diameter (mm)	2	4	6	8	10	12
N	For High silicon Aluminum (Si>12%)	ap≤1D	200	n (min-1)	31850	15920	10620	7960	6370	5310
		ae≤0.15D		V_f (mm/min)	2870	2390	1910	1670	1620	2070
	Graphite	ap≤1.5D	250	n (min-1)	39810	19900	13270	9950	7960	6640
		ae≤0.5D		V_f (mm/min)	5970	4180	3580	3280	3580	3580

SG200- S4/R4/RN4

Side Milling :Graphite



Workpiece		Cutting Depth (mm)	Vc m/min	Tool Diameter (mm)	2	4	6	8	10	12
N	For High silicon Aluminum (Si>12%)	ap≤1D	200	n (min-1)	31850	15920	10620	7960	6370	5310
		ae≤0.15D		V_f (mm/min)	3820	3190	2550	2230	2170	2760
	Graphite	ap≤1.5D	250	n (min-1)	39810	19900	13270	9950	7960	6640
		ae≤0.5D		V_f (mm/min)	7960	5570	4780	4380	4780	4780

【Note】

1. Use machine and holder with high rigidity .
2. Adjust the speed, feed and cutting depth according to actual cutting condition.
3. The milling conditions should be applied for the tool overhang length less than 4*D (mill dia).If the tool overhang length is too long, please adjust the speed, feed and cutting depth.

Recommended Cutting Data

SG200- S2/SN2/R2/RN2

Slot Milling :Graphite



Workpiece		Cutting Depth (mm)	Vc m/min	Tool Diameter (mm)	2	4	6	8	10	12
N	For High silicon Aluminum (Si>12%)	ap≤0.5D	180	$\frac{n}{(\min-1)}$	28660	14330	9550	7170	5730	4780
				$\frac{vf}{(\text{mm}/\text{min})}$	1150	1150	960	860	800	860
	Graphite	ap≤0.5D	200	$\frac{n}{(\min-1)}$	31850	15920	10620	7960	6370	5310
				$\frac{vf}{(\text{mm}/\text{min})}$	1910	1430	1380	1350	1400	1590

SG200-S3

Slot Milling :Graphite



Workpiece		Cutting Depth (mm)	Vc m/min	Tool Diameter (mm)	2	4	6	8	10	12
N	For High silicon Aluminum (Si>12%)	ap≤0.5D	180	$\frac{n}{(\min-1)}$	28660	14330	9550	7170	5730	4780
				$\frac{vf}{(\text{mm}/\text{min})}$	1720	1720	1430	1290	1200	1290
	Graphite	ap≤0.5D	200	$\frac{n}{(\min-1)}$	31850	15920	10620	7960	6370	5310
				$\frac{vf}{(\text{mm}/\text{min})}$	2870	2150	2070	2030	2100	2390

SG200-B2/BN2

Profile Milling :Graphite



Workpiece		Cutting Depth (mm)	Vc m/min	Tool Diameter (mm)	2	4	6	8	10	12
N	For High silicon Aluminum (Si>12%)	ap≤0.3D	200	$\frac{n}{(\min-1)}$	31850	15920	10620	7960	6370	5310
		ae≤0.3D		$\frac{vf}{(\text{mm}/\text{min})}$	2040	1430	1270	1270	1400	1380
	Graphite	ap≤0.5D	250	$\frac{n}{(\min-1)}$	39810	19900	13270	9950	7960	6640
		ae≤0.4D		$\frac{vf}{(\text{mm}/\text{min})}$	2790	1990	1860	1790	1910	1990

SG200-M-RN4/B2/BN2

Profile Milling :Graphite



Workpiece		Cutting Depth (mm)	Cutting Application	$\frac{n}{(\min-1)}$	Feed Spd (mm/min)
N	Graphite	0.03≤ap≤0.05 0.03≤ae≤0.05	General Condition	10000~15000	2000~3000
			High Speed Condition	25000~32000	3500~4500

【Note】

1. Use machine and holder with high rigidity.
2. Adjust the speed, feed and cutting depth according to actual cutting condition.
3. The milling conditions should be applied for the tool overhang length less than 4*D (mill dia). If the tool overhang length is too long, please adjust the speed, feed and cutting depth.

Recommended Cutting Data

ST210—S4/R4/RN4

Side Milling: Titanium Alloys



Workpiece		Cutting Depth (mm)	Vc m/min	Tool Diameter (mm)	2	3	4	5	6	8	10	12	16	20
S	Titanium Alloys	$ap \leq 1.5D$	60 (40~100)	n (min-1)	9555	6370	4780	3820	3185	2390	1910	1590	1195	955
		$ae \leq 0.25D$		vf (mm/min)	380	305	285	305	320	335	345	350	310	305
M	Stainless Steel	$ap \leq 1.5D$	80 (60~110)	n (min-1)	12740	8490	6370	5095	4245	3185	2545	2020	1590	1275
		$ae \leq 0.25D$		vf (mm/min)	760	575	510	510	510	510	510	485	445	430

ST210-S4/R4/RN4

Slot Milling: Titanium Alloys



Workpiece		Cutting Depth (mm)	Vc m/min	Tool Diameter (mm)	2	3	4	5	6	8	10	12	16	20
S	Titanium Alloys	$ap \leq 1D$	40 (30~60)	n (min-1)	6370	4245	3185	2545	2120	1590	1270	1060	795	635
		$ae \leq 1D$		vf (mm/min)	255	200	190	170	170	190	200	210	190	190
M	Stainless Steel	$ap \leq 1D$	60 (50~70)	n (min-1)	9555	6370	4775	3820	3185	2390	1910	1590	1195	955
		$ae \leq 1D$		vf (mm/min)	380	305	285	305	320	335	345	350	310	305

Recommended Cutting Data

ST210—RL5

Side Milling: Titanium Alloys



Workpiece		Cutting Depth (mm)	Vc m/min	Tool Diameter (mm)	16	20	25
S	Titanium Alloys	$ap \leq 0.7 \cdot Lc$	50 (40-60)	n (min-1)	980	780	620
		$ae \leq 0.1D$		vf (mm/min)	390	370	300

Remark: Lc is the length of the edge

【Note】

1. Pls pay attention to use machine and holder with high rigidity .
2. Please adjust the speed,feed and cutting depth according to actual cutting conditions.

ST210-B4

Profile Milling: Titanium Alloys



Workpiece		Cutting Depth (mm)	Vc m/min	Tool Diameter (mm)	2	3	4	5	6	8	10	12	16	20
S	Titanium Alloys	$ap \leq 0.2D$	70 (60~80)	n (min-1)	8000	6300	5580	4500	3715	2785	2230	1860	1390	1120
		$ae \leq 0.3D$		vf (mm/min)	800	1000	1000	800	670	610	535	480	445	360

【Note】

1. When the milling cutter is clamped, the maximum T.I.R. should be controlled below 0.01mm.
2. Pls pay attention to use machine and holder with high rigidity .
3. Please adjust the speed,feed and cutting depth according to actual cutting conditions.
4. The milling conditions are for an end mill where the tool overhang length is less than $4 \cdot D$ (mill dia).When the tool overhang length is longer, please adjust the speed,feed and cutting depth.

Recommended Cutting Data

SM200-TP2

Profile Milling: Titanium Alloys



Workpiece		Cutting Depth (mm)	Tool Diameter (mm)	1	1.5	2	3
S	Titanium Alloys	$ap=0.05D$	$\frac{n}{(\text{min}-1)}$	37900	30600	23700	15800
		$ae=0.3D$	$\frac{vf}{(\text{mm}/\text{min})}$	860~1150	1390	1080~1430	1430

SM200-RO2/RO3/VH2/VH3/WI2/WI3/IM2/IM3/KL2

Profile Milling: Zirconia



Workpiece		Cutting Depth (mm)	Tool Diameter (mm)	0.6	1	2
N	Zirconia	$ap=0.05D$	$\frac{n}{(\text{min}-1)}$	26800~29200	23000~25600	18300
		$ae=0.3D$	$\frac{vf}{(\text{mm}/\text{min})}$	320~350	460~510	730

SM200-ZI2/ZI3

Profile Milling: Zirconia, Titanium Alloys



Workpiece		Cutting Depth (mm)	Tool Diameter (mm)	1	2	3
N	Zirconia	$ap=0.05D$	$\frac{n}{(\text{min}-1)}$	23000~25600	18300	--
		$ae=0.3D$	$\frac{vf}{(\text{mm}/\text{min})}$	460~510	730	--
S	Titanium Alloys	$ap=0.05D$	$\frac{n}{(\text{min}-1)}$	--	18300	12200
		$ae=0.3D$	$\frac{vf}{(\text{mm}/\text{min})}$	--	690~920	920

Recommended Cutting Data

SM200-AR2/AR3/XT2

Profile Milling: Zirconia, Titanium Alloys



Workpiece		Cutting Depth (mm)	Tool Diameter (mm)	0.6	1	1.5	2	3
N	Zirconia	ap=0.05D	n (min-1)	26800~29200	23000~25600	--	18300	--
		ae=0.3D	vf (mm/min)	320~350	460~510	--	730	--
S	Titanium Alloys	ap=0.05D	n (min-1)	--	29200	23600	18300	12200
		ae=0.3D	vf (mm/min)	--	550~7440	890	690~920	920

【Note】

- 1、 Please select the corresponding machine tool and shank according to the type of cutting tool.
- 2、 Adjust the speed, feed and cutting depth according to actual cutting condition.
- 3、 The milling conditions should be applied for the tool overhang length less than 4*D (mill dia).If the tool overhang length is too long, please adjust the speed, feed and cutting depth.

Recommended Cutting Data

SN200-R4/RH4

Side Milling: Heat Resistant Super Alloys



Workpiece		Cutting Depth (mm)	Vc m/min	Tool Diameter (mm)	1	2	3	4	5	6	8	10	12	16	20
S	TA Titanium Alloys	$ap \leq 1D$	25 (15-35)	n (min-1)	7900	3980	2650	1990	1592	1325	995	795	660	495	400
		$ae \leq 0.1D$		vf (mm/min)	550	280	210	160	125	160	160	190	185	160	160
	TC Titanium Alloys	$ap \leq 1D$	20 (15-30)	n (min-1)	6370	3180	2100	1590	1270	1060	795	635	530	400	320
		$ae \leq 0.1D$		vf (mm/min)	470	240	170	130	120	125	125	150	145	125	140
	TB Titanium Alloys	$ap \leq 1D$	25 (15-30)	n (min-1)	7900	3980	2650	1990	1592	1325	995	795	660	495	400
		$ae \leq 0.1D$		vf (mm/min)	550	280	210	160	125	160	160	190	185	160	160

SN200-R4/RH4

Slot Milling: Heat Resistant Super Alloys



Workpiece		Cutting Depth (mm)	Vc m/min	Tool Diameter (mm)	1	2	3	4	5	6	8	10	12	16	20
S	TA Titanium Alloys	$ap \leq 0.5D$	20 (10-30)	n (min-1)	6370	3180	2100	1590	1270	1060	795	635	530	400	320
		$ae \leq 1D$		vf (mm/min)	280	230	160	120	120	105	95	90	95	80	65
	TC Titanium Alloys	$ap \leq 0.5D$	15 (10-25)	n (min-1)	4750	2380	1590	1190	950	795	600	475	400	300	240
		$ae \leq 1D$		vf (mm/min)	220	200	120	80	80	65	60	60	60	60	55
	TB Titanium Alloys	$ap \leq 0.5D$	20 (10-30)	n (min-1)	6370	3180	2100	1590	1270	1060	795	635	530	400	320
		$ae \leq 1D$		vf (mm/min)	280	230	160	120	120	105	95	90	95	80	65

【Note】

1. When the milling cutter is clamped, the maximum T.I.R. should be controlled below 0.01mm.
2. Pls pay attention to use machine and holder with high rigidity .
3. Please adjust the speed,feed and cutting depth according to actual cutting conditions.
4. The milling conditions are for an end mill where the tool overhang length is less than $4 \cdot D$ (mill dia).When the tool overhang length is longer, please adjust the speed,feed and cutting depth.

Recommended Cutting Data

SN200-B4/BH4

Profile Milling: Titanium Alloys



Workpiece		Cutting Depth (mm)	Vc m/min	Tool Diameter (mm)	2	3	4	5	6	8	10	12
S	TA Titanium Alloys	$ap \leq 0.04D$	40 (30-50)	$\frac{n}{(\min-1)}$	6370	4250	3180	2550	2120	1590	1270	1060
		$ae \leq 0.04D$		$\frac{vf}{(\text{mm}/\text{min})}$	500	420	350	300	255	285	305	340
	TC Titanium Alloys	$ap \leq 0.04D$	35 (25-45)	$\frac{n}{(\min-1)}$	5570	3710	2780	2230	1855	1390	1115	930
		$ae \leq 0.04D$		$\frac{vf}{(\text{mm}/\text{min})}$	440	360	270	260	220	220	265	260
	TB Titanium Alloys	$ap \leq 0.03D$	40 (30-50)	$\frac{n}{(\min-1)}$	6370	4250	3180	2550	2120	1590	1270	1060
		$ae \leq 0.03D$		$\frac{vf}{(\text{mm}/\text{min})}$	500	420	350	300	255	285	305	320

【Note】

1. When the milling cutter is clamped, the maximum T.I.R. should be controlled below 0.01mm.
2. Pls pay attention to use machine and holder with high rigidity .
3. Please adjust the speed,feed and cutting depth according to actual cutting conditions.
4. The milling conditions are for an end mill where the tool overhang length is less than $4 \cdot D$ (mill dia).When the tool overhang length is longer, please adjust the speed,feed and cutting depth.

Recommended Cutting Data

SD200-CN

Side Milling: Compound Material



Workpiece		Cutting Depth (mm)	Vc m/min	Tool Diameter (mm)	2	4	6	8	10	12
N	Carbon fibre CFRP	$ap \leq 2D$	140 (80-200)	$\frac{n}{(\min-1)}$	15000	8000	7430	5570	4460	3715
		$ae \leq 0.2D$		$\frac{vf}{(\text{mm}/\text{min})}$	900	480	445	445	445	370
	Glass fibre CFRP	$ap \leq 2D$	150 (100-200)	$\frac{n}{(\min-1)}$	15000	8000	7960	5970	4775	3980
		$ae \leq 0.2D$		$\frac{vf}{(\text{mm}/\text{min})}$	900	480	475	475	475	400

SD200-CN

Slot Milling: Compound Material



Workpiece		Cutting Depth (mm)	Vc m/min	Tool Diameter (mm)	2	4	6	8	10	12
N	Carbon fibre CFRP	$ap \leq 1D$	120 (80-160)	$\frac{n}{(\min-1)}$	15000	8000	6370	4775	3820	3185
		$ae \leq 1D$		$\frac{vf}{(\text{mm}/\text{min})}$	600	320	255	285	305	320
	Glass fibre CFRP	$ap \leq 1D$	150 (100-200)	$\frac{n}{(\min-1)}$	15000	8000	7960	5970	4775	3980
		$ae \leq 1D$		$\frac{vf}{(\text{mm}/\text{min})}$	600	320	320	360	380	400

【Note】

1. Please use a machine and holder with high rigidity.
2. Please adjust the speed, feed, and cutting depth according to actual cutting conditions.
3. The milling conditions should be applied for a tool overhang length less than $4 \cdot D$ (mill diameter). If the tool overhang length is too long, please adjust the speed, feed, and cutting depth.

Recommended Cutting Data

SH160-S2/R2

Side Milling: Alloys Steel, Hardened Steel



Workpiece		Cutting Depth (mm)	Vc m/min	Tool Diameter (mm)	2	4	6	8	10	12	16	20
H	Alloy Steel, Hardened Steel (<55HRC)	$ap \leq 1D$	120	n (min-1)	19110	9550	6370	4780	3820	3190	2390	1910
		$ae \leq 0.05D$		Vf (mm/min)	380	380	380	380	370	360	310	290
	Alloy Steel, Hardened Steel (55-60HRC)	$ap \leq 0.7D$	90	n (min-1)	15920	11940	7960	5970	4780	3980	2990	2390
		$ae \leq 0.03D$		Vf (mm/min)	260	360	370	360	360	330	320	290

SH160-S4/SH4/S6/R4/RH4

Side Milling: Alloys Steel, Hardened Steel



Workpiece		Cutting Depth (mm)	Vc m/min	Tool Diameter (mm)	2	4	6	8	10	12	16	20
H	Alloy Steel, Hardened Steel (<55HRC)	$ap \leq 1D$	120	n (min-1)	19110	9550	6370	4780	3820	3190	2390	1910
		$ae \leq 0.05D$		Vf (mm/min)	760	760	760	760	730	710	620	570
	Alloy Steel, Hardened Steel (55-60HRC)	$ap \leq 0.7D$	90	n (min-1)	15920	11940	7960	5970	4780	3980	2990	2390
		$ae \leq 0.03D$		Vf (mm/min)	510	720	730	720	730	670	630	570

SH160-B2/BH2

Profile Milling : Alloys Steel ,Hardened Steel



Workpiece		Cutting Depth (mm)	Vc m/min	Tool Diameter (mm)	2	4	6	8	10	12	14	16
H	Alloy Steel, Hardened Steel (<55HRC)	$ap \leq 0.03D$	200	n (min-1)	31850	15920	10620	7960	6370	5310	4550	3980
		$ae \leq 0.03D$		Vf (mm/min)	510	570	590	610	570	570	530	490
	Alloy Steel, Hardened Steel (55-60HRC)	$ap \leq 0.02D$	150	n (min-1)	23890	11940	7960	5970	4780	3980	3410	2990
		$ae \leq 0.03D$		Vf (mm/min)	330	310	320	330	330	320	310	300

SH160-B4

Profile Milling : Alloys Steel ,Hardened Steel



Workpiece		Cutting Depth (mm)	Vc m/min	Tool Diameter (mm)	2	4	6	8	10	12	14	16
H	Alloy Steel, Hardened Steel (<55HRC)	$ap \leq 0.03D$	200	n (min-1)	31850	15920	10620	7960	6370	5310	4550	3980
		$ae \leq 0.03D$		Vf (mm/min)	1020	1150	1190	1210	1150	1150	1060	990
	Alloy Steel, Hardened Steel (55-60HRC)	$ap \leq 0.02D$	150	n (min-1)	23890	11940	7960	5970	4780	3980	3410	2990
		$ae \leq 0.03D$		Vf (mm/min)	670	620	640	670	670	640	610	600

[Note]

- Please attention to use machine and holder with high rigidity .
- Please adjust the speed, feed and cutting depth according to actual cutting conditions.
- The milling conditions are for an end mill where the tool overhang length is less than $4 \cdot D$ (mill dia).When the tool overhang length is longer, please adjust the speed, feed and cutting depth.

Recommended Cutting Data

SH260- S2/SN2/R2/RN2-H

Slot Milling: Alloys Steel, Hardened Steel



Workpiece		Cutting Depth (mm)	Cutting Condition (mm)	Tool Diameter (mm)					
				2	4	6	8	10	12
P	Alloy Steel (30-45HRC)	ae=1D	$\frac{n}{(\min-1)}$	20000	10350	8500	6600	5250	4400
		ap≤0.05D	$\frac{vf}{(\text{mm}/\text{min})}$	520	550	630	610	580	580
H	Hardened Steel (45-55HRC)	ae=1D	$\frac{n}{(\min-1)}$	16000	8300	5200	3800	3100	2800
		ap≤0.02D	$\frac{vf}{(\text{mm}/\text{min})}$	380	410	340	320	300	300
	Hardened Steel (55-60HRC)	ae=1D	$\frac{n}{(\min-1)}$	13500	6800	4600	3000	2400	2000
		ap≤0.01D	$\frac{vf}{(\text{mm}/\text{min})}$	240	240	230	190	180	170

SH260- S2/SN2/R2/RN2-H

Side Milling: Alloys Steel, Hardened Steel



Workpiece		Cutting Depth (mm)	Cutting Condition (mm)	Tool Diameter (mm)					
				2	4	6	8	10	12
P	Alloy Steel (30-45HRC)	ap≤0.8D	$\frac{n}{(\min-1)}$	20000	10350	8500	6600	5250	4400
		ae≤0.03D	$\frac{vf}{(\text{mm}/\text{min})}$	720	750	880	610	820	820
H	Hardened Steel (45-55HRC)	ap≤0.5D	$\frac{n}{(\min-1)}$	16000	8300	5200	3800	3100	2800
		ae≤0.03D	$\frac{vf}{(\text{mm}/\text{min})}$	540	570	520	460	420	420
	Hardened Steel (55-60HRC)	ap≤0.5D	$\frac{n}{(\min-1)}$	13500	6800	4600	3000	2400	2000
		ae≤0.01D	$\frac{vf}{(\text{mm}/\text{min})}$	340	360	350	270	250	250

【Note】

1. Please use a machine and holder with high rigidity.
2. Please adjust the speed, feed, and cutting depth according to actual cutting conditions.
3. The milling conditions should be applied for a tool overhang length less than 4*D (mill diameter). If the tool overhang length is too long, please adjust the speed, feed, and cutting depth.

Recommended Cutting Data

SH260- S4/S4A/SH4/SH4A/SL4/SL4A/SN4/R4/R4A/RH4/RN4-H

Side Milling :Alloys Steel, Hardened Steel



Workpiece	Cutting Depth (mm)	Cutting Application	Cutting Condition (mm)	Tool Diameter (mm)						
				2	4	6	8	10	12	
P	Alloy Steel (30-45HRC)	$ap \leq 1.2D$ $ae \leq 0.08D$	General Condition	n (min-1)	14000	7200	4800	3600	2900	2400
				vf (mm/min)	800	900	1000	1100	1050	1000
			High Speed Condition	n (min-1)	20000	10000	7000	5200	4200	3600
				vf (mm/min)	1200	1400	1600	1800	1600	1500
H	Hardened Steel (45-55HRC)	$ap \leq 1.0D$ $ae \leq 0.04D$	General Condition	n (min-1)	12500	6400	4200	3200	2500	2100
				vf (mm/min)	500	600	700	800	700	640
			High Speed Condition	n (min-1)	18000	9200	6100	4600	3600	3000
				vf (mm/min)	900	1150	1300	1400	1300	1200
	Hardened Steel (55-60HRC)	$ap \leq 0.8D$ $ae \leq 0.02D$	General Condition	n (min-1)	11000	5600	3700	2800	2200	1900
				vf (mm/min)	440	500	580	630	570	550
			High Speed Condition	n (min-1)	15000	8000	5300	4000	3200	2700
				vf (mm/min)	790	900	1040	1100	1000	900

SH260- S6/SH6/SL6-H

Side Milling :Alloys Steel, Hardened Steel



Workpiece	Cutting Depth (mm)	Cutting Condition (mm)	Tool Diameter (mm)						
			6	8	10	12	16	20	
P	Alloy Steel (30-45HRC)	$ap \leq 1.5D$ $ae \leq 0.05D$	n (min-1)	6200	4800	4000	3200	2400	1600
			vf (mm/min)	1674	1584	1560	1440	1296	960
H	Hardened Steel (45-55HRC)	$ap \leq 1.5D$ $ae \leq 0.03D$	n (min-1)	4500	3600	3000	2400	1800	1200
			vf (mm/min)	1215	1188	1170	1080	972	720
	Hardened Steel (55-60HRC)	$ap \leq 1.5D$ $ae \leq 0.02D$	n (min-1)	3100	2400	2000	1600	1200	800
			vf (mm/min)	744	720	720	627	576	432

【Note】

1. Please use a machine and holder with high rigidity.
2. Please adjust the speed, feed, and cutting depth according to actual cutting conditions.
3. The milling conditions should be applied for a tool overhang length less than $4 \cdot D$ (mill diameter). If the tool overhang length is too long, please adjust the speed, feed, and cutting depth.

Recommended Cutting Data

SH260-B2/BH2/BN2-H

Profile Milling : Alloys Steel ,Hardened Steel



Workpiece	Cutting Depth (mm)	Cutting Application	Cutting Condition (mm)	Tool Diameter (mm)						
				2	4	6	8	10	12	
P	Alloy Steel (30-45HRC)	ap=0.05~0.1D ae≤0.02D	General Condition	n (min-1)	20000	10300	6900	5100	4100	3400
				vf (mm/min)	1500	1650	1650	1700	1700	1750
			High Speed Condition	n (min-1)	35000	17500	11600	8700	7000	6000
				vf (mm/min)	2600	2700	2700	2850	2850	2900
H	Hardened Steel (45-55HRC)	ap=0.05~0.1D ae≤0.02D	General Condition	n (min-1)	15900	8000	5300	4000	3200	2600
				vf (mm/min)	1200	1300	1300	1350	1350	1400
			High Speed Condition	n (min-1)	28600	14300	9500	7200	5700	4500
				vf (mm/min)	2200	2300	2300	2350	2350	2400
	Hardened Steel (55-60HRC)	ap=0.05~0.1D ae≤0.02D	General Condition	n (min-1)	12000	6000	4000	2900	2400	2100
				vf (mm/min)	900	960	960	920	920	900
			High Speed Condition	n (min-1)	25400	12700	8500	6400	5000	1900
				vf (mm/min)	1800	1800	1800	1500	1500	1500

【Note】

- 1、 Please attention to use machine and holder with high rigidity .
- 2、 Please adjust the speed,feed and cutting depth according to actual cutting conditions.
- 3、 The milling conditions should be applied for the tool overhang length less than 4*D (mill dia).If the tool overhang length is too long, please adjust the speed, feed and cutting depth.

Recommended Cutting Data

SH360- S2

Slot Milling : Alloys Steel, Pre-hardened Steel, Hardened Steel



Workpiece	Cutting Depth (mm)	Cutting Condition (mm)	Tool Diameter (mm)						
			2	4	6	8	10	12	
H	Alloy Steel, Pre-hardened Steel (30-45HRC)	Ae=1.0D Ap≤0.05D	n (min-1)	20000	10350	8500	6600	5250	4400
			vf (mm/min)	520	550	630	610	580	580
	Alloy Steel, Hardened Steel (45-55HRC)	Ae=1.0D Ap≤0.02D	n (min-1)	16000	8300	5200	3800	3100	2800
			vf (mm/min)	380	410	340	320	300	300
	Alloy Steel, Hardened Steel (55-65HRC)	Ae=1.0D Ap≤0.01D	n (min-1)	13500	6800	4600	3000	2400	2000
			vf (mm/min)	240	240	230	190	180	170

SH360- S2

Side Milling : Alloys Steel, Pre-hardened Steel, Hardened Steel



Workpiece	Cutting Depth (mm)	Cutting Condition (mm)	Tool Diameter (mm)						
			2	4	6	8	10	12	
H	Alloy Steel, Pre-hardened Steel (30-45HRC)	Ap≤1.5D Ae≤0.03D	n (min-1)	20000	10350	8500	6600	5250	4400
			vf (mm/min)	720	750	880	610	820	820
	Alloy Steel, Hardened Steel (45-55HRC)	Ap≤1.5D Ae≤0.03D	n (min-1)	16000	8300	5200	3800	3100	2800
			vf (mm/min)	540	570	520	460	420	420
	Alloy Steel, Hardened Steel (55-65HRC)	Ap≤1.5D Ae≤0.01D	n (min-1)	13500	6800	4600	3000	2400	2000
			vf (mm/min)	340	360	350	270	250	250

【Note】

1. Please attention to use machine and holder with high rigidity .
2. Please adjust the speed, feed and cutting depth according to actual cutting conditions.
3. The milling conditions should be applied for the tool overhang length less than 4*D (mill dia).If the tool overhang length is too long, please adjust the speed, feed and cutting depth.
4. Recommended Coolant: Oil Mist, Cutting Oil.

Recommended Cutting Data

SH360- S4A/SH4A/R4/RH4

Side Milling: Alloys Steel, Pre-hardened Steel, Hardened Steel



Workpiece	Cutting Depth (mm)	Cutting Application	Cutting Condition	Tool Diameter (mm)							
				2	4	6	8	10	12	16	20
H Alloy Steel, Pre-hardened Steel (30-45HRC)	Ap ≤ 1.5D Ae ≤ 0.08D	General Condition	n (min-1)	15000	8000	5300	4000	3200	2700	200	1600
			vf (mm/min)	680	840	870	890	830	780	760	720
		High Speed Condition	n (min-1)	40000	20000	13000	10000	8000	6600	5000	4000
			vf (mm/min)	2910	3360	4390	4500	4320	3960	6750	3600
H Alloy Steel, Hardened Steel (45-55HRC)	Ap ≤ 1.5D Ae ≤ 0.04D	General Condition	n (min-1)	13000	6000	4200	3200	2500	2100	1600	1300
			vf (mm/min)	520	520	870	890	830	780	760	720
		High Speed Condition	n (min-1)	32000	16000	11000	8000	6400	5300	400	3200
			vf (mm/min)	1830	2110	3270	3170	3040	2800	2640	2530
H Alloy Steel, Hardened Steel (55-65HRC)	Ap ≤ 1.5D Ae ≤ 0.02D	General Condition	n (min-1)	9600	4800	3200	2400	1900	1600	1200	1000
			vf (mm/min)	350	380	600	600	570	540	520	500
		High Speed Condition	n (min-1)	24000	12000	8000	6000	4800	4000	3000	2400
			vf (mm/min)	1250	1440	2160	2160	2070	1920	1800	1730

SH360- S6/SL6

Side Milling: Alloys Steel, Pre-hardened Steel, Hardened Steel



Workpiece	Cutting Depth (mm)	Cutting Application	Cutting Condition	Tool Diameter (mm)							
				2	4	6	8	10	12	16	20
H Alloy Steel, Pre-hardened Steel (30-45HRC)	Ap ≤ 1.5D Ae ≤ 0.08D	General Condition	n (min-1)	16000	9300	6200	4800	4000	3200	2400	1920
			vf (mm/min)	1600	1650	1774	1684	1650	1540	1396	1060
		High Speed Condition	n (min-1)	43000	21500	14400	10800	8600	7200	5400	4300
			vf (mm/min)	3910	4360	5294	5294	5140	4720	4386	3940
H Alloy Steel, Hardened Steel (45-55HRC)	Ap ≤ 1.5D Ae ≤ 0.04D	General Condition	n (min-1)	13500	6500	4500	3600	3000	2400	1800	1300
			vf (mm/min)	1000	1020	1215	1188	1170	1080	972	920
		High Speed Condition	n (min-1)	32500	16800	11300	8400	6900	5600	4200	3200
			vf (mm/min)	2550	2650	3615	3468	3380	3100	2852	2730
H Alloy Steel, Hardened Steel (55-65HRC)	Ap ≤ 1.5D Ae ≤ 0.02D	General Condition	n (min-1)	11400	5700	3800	2900	2400	2000	1500	1200
			vf (mm/min)	500	600	744	720	720	627	576	532
		High Speed Condition	n (min-1)	25800	12900	8600	6500	5300	4400	3300	2600
			vf (mm/min)	1400	1660	2304	2280	2220	2007	1856	1762

【Note】

1. Please attention to use machine and holder with high rigidity .
2. Please adjust the speed, feed and cutting depth according to actual cutting conditions.
3. The milling conditions should be applied for the tool overhang length less than 4*D (mill dia).If the tool overhang length is too long, please adjust the speed, feed and cutting depth.
4. Recommended Coolant: Oil Mist, Cutting Oil.

Recommended Cutting Data

SH360-B2/BH2

Profile Milling: Alloy Steel, Pre-hardened Steel, Hardened Steel



Workpiece	Cutting Depth (mm)	Cutting Application	Cutting Condition (mm)	Ball Radius R (mm)							
				R1	R2	R3	R4	R5	R6	R8	
H	Alloy Steel, Pre-hardened Steel (30-45HRC)	General Condition	n (min-1)	20000	10300	6900	5100	4100	3400	2550	
			vf (mm/min)	1500	1650	1650	1700	1700	1750	1750	
		High Speed Condition	n (min-1)	35000	17500	11600	8700	7000	6000	4500	
			vf (mm/min)	2600	2700	2700	2850	2850	2900	2900	
	Alloy Steel, Hardened Steel (45-55HRC)	General Condition	n (min-1)	15900	8000	5300	4000	3200	2600	1950	
			vf (mm/min)	1200	1300	1300	1350	1350	1400	1400	
High Speed Condition		n (min-1)	28600	14300	9500	7200	5700	4500	3380		
		vf (mm/min)	2200	2300	2300	2350	2350	2400	2400		
Alloy Steel, Hardened Steel (55-65HRC)	General Condition	n (min-1)	12000	6000	4000	2900	2400	2100	1600		
		vf (mm/min)	900	960	960	920	920	900	900		
	High Speed Condition	n (min-1)	25400	12700	8500	6400	5000	1900	1450		
		vf (mm/min)	1800	1800	1800	1500	1500	1500	1500		

【Note】

1. Please attention to use machine and holder with high rigidity .
2. Please adjust the speed, feed and cutting depth according to actual cutting conditions.
3. The milling conditions should be applied for the tool overhang length less than $4 \cdot D$ (mill dia).If the tool overhang length is too long, please adjust the speed, feed and cutting depth.
4. Recommended Coolant: Oil Mist, Cutting Oil.

Recommended Cutting Data

SH360-B4/BH4

Profile Milling: Alloys Steel, Pre-hardened Steel, Hardened Steel



Workpiece	Cutting Depth (mm)	Cutting Application	Cutting Condition (mm)	Ball Radius R (mm)							
				R1	R2	R3	R4	R5	R6	R8	
H	Alloy Steel, Pre-hardened Steel (30-45HRC) Ap=0.05~0.1 Ae≤0.02D	General Condition	n (min-1)	20000	10300	6900	5100	4100	3400	2550	
			vf (mm/min)	1500	1650	1650	1700	1700	1750	1750	
		High Speed Condition	n (min-1)	35000	17500	11600	8700	7000	6000	4500	
			vf (mm/min)	2600	2700	2700	2850	2850	2900	2900	
	Alloy Steel, Hardened Steel (45-55HRC) Ap=0.05~0.1 Ae≤0.02D	General Condition	n (min-1)	15900	8000	5300	4000	3200	2600	1950	
			vf (mm/min)	1200	1300	1300	1350	1350	1400	1400	
High Speed Condition		n (min-1)	28600	14300	9500	7200	5700	4500	3380		
		vf (mm/min)	2200	2300	2300	2350	2350	2400	2400		
Alloy Steel, Hardened Steel (55-65HRC) Ap=0.05~0.1 Ae≤0.02D	General Condition	n (min-1)	12000	6000	4000	2900	2400	2100	1600		
		vf (mm/min)	900	960	960	920	920	900	900		
	High Speed Condition	n (min-1)	25400	12700	8500	6400	5000	1900	1450		
		vf (mm/min)	1800	1800	1800	1500	1500	1500	1500		

[Note]

1. Please attention to use machine and holder with high rigidity .
2. Please adjust the speed, feed and cutting depth according to actual cutting conditions.
3. The milling conditions should be applied for the tool overhang length less than 4*D (mill dia).If the tool overhang length is too long, please adjust the speed, feed and cutting depth.
4. Recommended Coolant: Oil Mist, Cutting Oil.

Recommended Cutting Data

FH200-R4/RN4-H

Face Milling :Alloys Steel, Hardened Steel



Workpiece	Cutting Depth (mm)	Vc m/min	Cutting Condition (mm)	Tool Diameter(mm)						
				1	2	4	6	8	10	12
P Alloy Steel (< 48HRC)	ap≤0.03D	150	n (min-1)	40000	24000	12000	8000	6500	5000	4500
	ae≤0.5D		vf (mm/min)	2640	3120	3840	5760	5760	5800	5200
H Alloy Steel Hardened Steel (45-55HRC)	ap≤0.025D	125	n (min-1)	33000	20000	10000	7000	5500	4000	3500
	ae≤0.5D		vf (mm/min)	2200	2600	3200	4800	4800	4400	3800
Alloy Steel Hardened Steel (55-65HRC)	ap≤0.02D	90	n (min-1)	23000	14000	7200	5000	3600	3000	2500
	ae≤0.5D		vf (mm/min)	2000	2500	2800	3500	3300	3000	2600

【Note】

1. It's a normal phenomenon that the cutting edge turns red during processing. As long as the machine has no obvious vibration or the cutting tool has no obvious collapse, it can continue to be used.
2. It is not suitable for large cutting depth and side milling.
3. Please adjust the speed, feed and cutting depth according to actual cutting conditions.
4. Air blow or oil mist is recommended for good chip evacuation.

FH200-R6/RN6/RH6-H

Face Milling : Alloys Steel, Hardened Steel



Workpiece	Cutting Depth (mm)	Vc m/min	Cutting Condition (mm)	Tool Diameter(mm)					
				6	8	10	12	16	20
P Alloy Steel (< 48HRC)	ap≤0.035D	60-90	n (min-1)	3200-4800	2400-3600	1900-2900	1600-2400	1200-1800	950-1450
	ae≤0.5D		vf (mm/min)	2200-3000	2200-3000	2200-3000	2200-3000	2500-3500	2500-3500
H Alloy Steel Hardened Steel (45-55HRC)	ap≤0.035D	60-90	n (min-1)	3200-4800	2400-3600	1900-2900	1600-2400	1200-1800	950-1450
	ae≤0.5D		vf (mm/min)	1920-2880	1950-2920	1950-2950	1920-2880	2160-3240	2280-3480

【Note】

1. It is normal for the cutting edge to turn red during processing. As long as there is no obvious vibration in the machine or obvious damage in the cutting tool, it can continue to be used.
2. The cutting speed is negatively correlated with tool life. To achieve better tool life, it is suggested that the cutting speed be selected between 60-80m/min.
3. Due to the special shape of the cutting edge, there will be corresponding tool contour marks on the surface of the workpiece, which can be easily removed by subsequent semi-finishing.
4. There is no cutting edge in the center of the tool, so vertical cutting is not allowed. The tool should be cut horizontally or obliquely from the edge of the workpiece.
5. It is not suitable for large cutting depths and side milling.

Programming Data

FH200-R6/RN6/RH6-H

Geometrical Parameters						Ramping Guide For Circular and Linear Ramping						
						Circular Interpolation		Linear Ramping				
						Optimal Range of Circle Diameter for A Single Pass		Calculated Length Per Ramp Angle (mm)				
Diameter	Ap1 max	R	R _ε	YRC	CRN	Smallest	largest	Ramp Angle(degree)				
[mm]	[mm]	[mm]	[mm]	[mm]	[mm]			1°	2°	3°	4°	5°
6	0.20	9	0.375	0.75	1.26	8.52	12.00	11.51	5.75	3.83	2.87	2.30
8	0.27	12	0.500	1.00	1.68	11.36	16.00	15.34	7.67	5.11	3.83	3.06
10	0.33	15	0.625	1.25	2.10	14.20	20.00	19.18	9.58	6.39	4.79	3.83
12	0.40	18	0.750	1.50	2.52	17.04	24.00	23.01	11.50	7.66	5.74	4.59
16	0.54	24	1.000	2.00	3.36	22.72	32.00	30.68	15.34	10.22	7.66	6.12
20	0.67	30	1.250	2.00	4.2	28.40	40.00	38.35	19.17	12.77	9.57	7.65
Recommended Percentage of Programmed Feed Rate To Use While Ramping								100%	70%	50%	30%	10%

R=the head radius size.

YRC=distance from centreline to the crown of the R radius.

CRN=distance from centreline to the start of the cutting edge. This dimension can also help determine the minimum circle size when helical ramping.

R_ε=the shoulder radius or radius at the corner of the cutter.

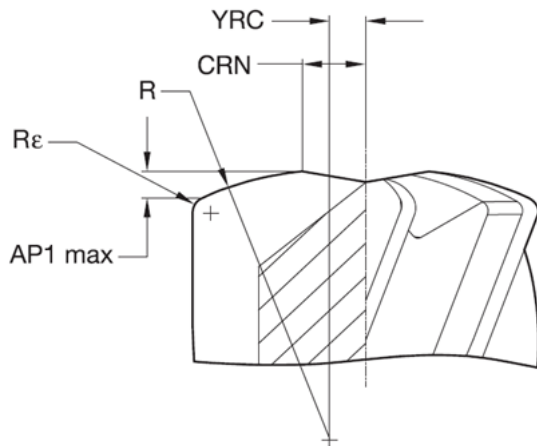

FH200-H Schematic diagram of the bottom edge of 6 flute corner radius endmill

Recommended Cutting Data (General Type)

SPM200-SN2/SHM200-SN2

2 Flute, Standard Length

Micro Diameter Endmills for Deep Machining

Workpiece Material			P						N		H			
			Carbon Steel, Alloy Steel (180~250HB)		Alloy Steel, Tool Steel (25~35HRC)		PH,Ferrite, Martensite Steel (35~45HRC)		Copper, Copper Alloys		Hardened Steel (45~55HRC)		Hardened Steel (55~65HRC)	
Ratio to standard depth of cut(ap)			1.00		0.90		0.70		1.20		0.50		0.45	
Mill Dia. (mm)	Under Neck Length (mm)	ap	n r/min	Vf mm/min	n r/min	Vf mm/min	n r/min	Vf mm/min	n r/min	Vf mm/min	n r/min	Vf mm/min	n r/min	Vf mm/min
0.1	0.3	0.006	45,000	450	45,000	428	43,740	313	50,000	500	38,475	230	36,045	187
	0.5	0.004	45,000	450	45,000	428	43,740	313	50,000	500	38,475	230	36,045	187
	1	0.003	45,000	410	43,740	387	39,330	284	50,000	455	34,650	209	32,445	168
0.2	0.5	0.02	40,500	574	36,450	517	34,425	363	45,000	637	30,375	271	28,350	218
	1	0.014	40,500	574	36,450	517	34,425	363	45,000	637	30,375	271	28,350	218
	1.5	0.008	36,450	473	32,805	425	30,983	326	43,740	567	27,338	244	25,515	196
	2	0.005	32,400	378	29,160	340	27,540	257	38,880	454	24,300	193	22,680	155
0.3	3	0.003	32,400	340	29,160	306	27,540	231	38,880	409	24,300	174	22,680	140
	1	0.021	36,000	510	32,400	459	30,600	322	43,200	612	27,000	240	25,200	194
	1.5	0.021	36,000	510	32,400	459	30,600	322	43,200	612	27,000	240	25,200	194
	2	0.012	32,400	420	29,160	378	27,540	290	38,880	504	24,300	217	22,680	175
	2.5	0.01	32,400	420	29,160	378	27,540	290	38,880	504	24,300	217	22,680	175
0.4	3	0.008	32,400	420	29,160	378	27,540	290	38,880	504	24,300	217	22,680	175
	1	0.04	28,800	635	25,920	572	24,480	401	34,560	762	21,600	300	20,160	241
	1.5	0.028	28,800	635	25,920	572	24,480	401	34,560	762	21,600	300	20,160	241
	2	0.028	28,800	635	25,920	572	24,480	401	34,560	762	21,600	300	20,160	241
	2.5	0.022	25,920	523	23,328	471	22,032	361	31,104	627	19,440	269	18,144	217
	3	0.016	25,920	523	23,328	471	22,032	361	31,104	627	19,440	269	18,144	217
	3.5	0.012	25,920	523	23,328	471	22,032	361	31,104	627	19,440	269	18,144	217
	4	0.01	25,920	523	23,328	471	22,032	361	31,104	627	19,440	269	18,144	217
	5	0.01	23,040	407	20,736	365	19,584	234	27,648	488	17,280	207	16,128	163
	6	0.006	23,040	407	20,736	365	19,584	234	27,648	488	17,280	207	16,128	163
0.5	8	0.003	20,160	310	18,144	279	17,136	180	24,192	372	15,120	155	14,112	118
	10	0.002	17,280	228	15,552	205	14,688	132	20,736	274	12,960	114	12,096	86
	1	0.05	28,800	635	25,920	572	24,480	482	34,560	762	21,600	300	20,160	241
	1.5	0.05	28,800	635	25,920	572	24,480	482	34,560	762	21,600	300	20,160	241
	2	0.035	28,800	635	25,920	572	24,480	482	34,560	762	21,600	300	20,160	241
	2.5	0.03	25,920	523	23,328	471	22,032	397	31,104	627	19,440	269	18,144	217
	3	0.02	25,920	523	23,328	471	22,032	397	31,104	627	19,440	269	18,144	217
4	0.02	25,920	523	23,328	471	22,032	361	31,104	627	19,440	269	18,144	217	
5	0.013	25,920	523	23,328	471	22,032	361	31,104	627	19,440	269	18,144	217	
6	0.013	23,040	407	20,736	365	19,584	234	27,648	488	17,280	207	16,128	163	

【Note】 Please refer to P593

Recommended Cutting Data (General Type)

SPM200-SN2/SHM200-SN2

2 Flute, Standard Length

Micro Diameter Endmills for Deep Machining

» Continuation

Workpiece Material			P						N		H			
			Carbon Steel, Alloy Steel (180~250HB)		Alloy Steel, Tool Steel (25~35HRC)		PH,Ferrite, Martensite Steel (35~45HRC)		Copper, Copper Alloys		Hardened Steel (45~55HRC)		Hardened Steel (55~65HRC)	
Ratio to standard depth of cut(ap)			1.00		0.90		0.70		1.20		0.50		0.45	
Mill Dia. (mm)	Under Neck Length (mm)	ap	n r/min	Vf mm/min	n r/min	Vf mm/min	n r/min	Vf mm/min	n r/min	Vf mm/min	n r/min	Vf mm/min	n r/min	Vf mm/min
0.5	8	0.008	23,040	348	20,736	313	19,584	222	27,648	418	17,280	175	16,128	132
	10	0.004	20,160	270	18,144	243	17,136	157	24,192	324	15,120	135	14,112	103
0.6	2	0.042	28,800	907	25,920	816	24,480	572	34,560	1,089	21,600	428	20,160	345
	3	0.035	25,920	746	23,328	671	22,032	516	31,104	896	19,440	385	18,144	311
	4	0.024	25,920	746	23,328	671	22,032	516	31,104	896	19,440	385	18,144	311
	5	0.02	25,920	746	23,328	671	22,032	516	31,104	896	19,440	385	18,144	311
	6	0.015	25,920	746	23,328	671	22,032	516	31,104	896	19,440	385	18,144	311
	7	0.015	23,040	644	20,736	580	19,584	445	27,648	773	17,280	332	16,128	268
	8	0.015	23,040	581	20,736	523	19,584	335	27,648	697	17,280	295	16,128	232
	9	0.012	23,040	581	20,736	523	19,584	335	27,648	697	17,280	295	16,128	232
	10	0.009	23,040	581	20,736	523	19,584	335	27,648	697	17,280	295	16,128	232
	0.7	2	0.07	28,800	907	25,920	816	24,480	572	34,560	1,089	21,600	428	20,160
4		0.049	25,920	746	23,328	671	22,032	516	31,104	896	19,440	385	18,144	311
6		0.018	25,920	746	23,328	671	22,032	516	31,104	896	19,440	385	18,144	311
8		0.018	23,040	581	20,736	523	19,584	335	27,648	697	17,280	295	16,128	232
10		0.018	23,040	581	20,736	523	19,584	335	27,648	697	17,280	295	16,128	232
0.8	4	0.056	28,800	907	25,920	816	24,480	702	34,560	1,089	21,600	619	20,160	380
	6	0.032	25,920	746	23,328	671	22,032	610	31,104	896	21,600	599	18,144	341
	8	0.02	25,920	746	23,328	671	22,032	516	31,104	896	19,440	385	18,144	311
	10	0.02	23,040	581	20,736	523	19,584	335	27,648	697	17,280	295	16,128	232
	12	0.012	23,040	581	20,736	523	19,584	335	27,648	697	17,280	295	16,128	232
0.9	6	0.036	25,920	895	23,328	806	22,032	618	31,104	985	19,440	500	18,144	373
	8	0.023	25,920	820	23,328	738	22,032	567	31,104	985	19,440	462	18,144	341
	10	0.023	23,040	581	20,736	523	19,584	335	27,648	697	17,280	295	16,128	232
	12	0.023	23,040	581	20,736	523	19,584	335	27,648	697	17,280	295	16,128	232
1	2	0.1	25,920	1,220	23,328	1,098	22,032	1,035	31,104	1,465	20,637	907	18,144	761
	3	0.085	25,920	1,220	23,328	1,098	22,032	1,035	31,104	1,465	20,637	907	18,144	761
	4	0.07	25,920	1,220	23,328	1,098	22,032	969	31,104	1,465	20,637	867	18,144	689
	5	0.055	25,920	1,220	23,328	1,098	22,032	925	31,104	1,465	20,637	784	18,144	617
	6	0.04	23,328	1,008	20,995	907	19,829	813	27,994	1,210	18,630	671	16,330	419
	7	0.04	23,328	1,008	20,995	907	19,829	753	27,994	1,210	18,630	633	16,330	419
	8	0.04	23,328	1,008	20,995	907	19,829	753	27,994	1,210	18,630	560	16,330	419

【Note】 Please refer to P593

Recommended Cutting Data (General Type)

SPM200-SN2/SHM200-SN2

2 Flute, Standard Length

» Continuation

Micro Diameter Endmills for Deep Machining

Workpiece Material			P						N		H			
			Carbon Steel, Alloy Steel (180~250HB)		Alloy Steel, Tool Steel (25~35HRC)		PH,Ferrite, Martensite Steel (35~45HRC)		Copper, Copper Alloys		Hardened Steel (45~55HRC)		Hardened Steel (55~65HRC)	
Ratio to standard depth of cut(ap)			1.00		0.90		0.70		1.20		0.50		0.45	
Mill Dia. (mm)	Under Neck Length (mm)	ap	n r/min	Vf mm/min	n r/min	Vf mm/min	n r/min	Vf mm/min	n r/min	Vf mm/min	n r/min	Vf mm/min	n r/min	Vf mm/min
1	9	0.033	23,328	1,008	20,995	907	19,829	696	27,994	1,210	17,496	519	16,330	419
	10	0.025	23,328	1,008	20,995	907	19,829	696	27,994	1,210	17,496	519	16,330	419
	12	0.025	20,736	784	18,662	706	17,626	452	24,883	941	15,552	399	14,515	313
	14	0.025	20,736	784	18,662	706	17,626	452	24,883	941	15,552	399	14,515	313
	16	0.015	20,736	671	18,662	605	17,626	428	24,883	806	15,552	336	14,515	255
	20	0.01	18,621	549	20,111	494	15,828	313	22,345	659	13,966	275	13,035	203
	25	0.005	15,750	427	17,010	384	13,388	243	18,900	512	11,813	213	11,025	158
1.2	6	0.084	23,040	1,089	20,736	980	19,584	783	27,648	1,307	17,280	513	16,128	414
	8	0.048	20,736	896	18,662	806	17,626	705	24,883	1,075	15,552	462	14,515	373
	10	0.03	20,736	896	18,662	806	17,626	670	24,883	1,075	15,552	462	14,515	373
	12	0.03	20,736	896	18,662	806	17,626	618	24,883	1,075	15,552	462	14,515	373
	16	0.02	18,432	796	16,589	716	15,667	550	22,118	955	13,824	410	12,902	331
1.4	6	0.1	20,160	952	18,144	858	17,136	601	24,192	1,143	15,120	449	14,112	363
	12	0.035	18,144	784	16,330	706	15,422	541	21,773	941	13,608	404	12,701	326
1.5	4	0.11	20,160	1,047	18,144	943	17,136	721	24,192	1,257	15,120	583	14,112	434
	6	0.11	20,160	1,047	18,144	943	17,136	721	24,192	1,257	15,120	561	14,112	434
	8	0.08	18,144	862	16,330	846	15,422	649	21,773	1,034	13,608	484	12,701	374
	10	0.06	18,144	784	16,330	776	15,422	649	21,773	1,034	13,608	484	12,701	374
	12	0.06	18,144	784	16,330	706	15,422	649	21,773	941	13,608	404	12,701	326
	14	0.038	18,144	784	16,330	706	15,422	649	21,773	941	13,608	404	12,701	326
	16	0.038	16,128	609	14,515	549	13,709	352	19,354	732	12,096	311	11,290	244
	18	0.038	16,128	609	14,515	549	13,709	352	19,354	732	12,096	311	11,290	244
	20	0.038	16,128	609	14,515	549	13,709	352	19,354	732	12,096	311	11,290	244
	25	0.023	12,096	392	10,886	353	10,282	250	14,515	471	9,072	196	8,467	149
	30	0.015	10,080	266	10,886	239	8,568	160	12,096	320	7,560	125	7,056	101
	35	0.01	10,080	266	10,886	239	8,568	160	12,096	320	7,560	125	7,056	101
40	0.005	8,064	142	7,258	128	6,854	86	9,677	171	6,048	67	5,645	54	
1.6	6	0.11	18,720	1,081	16,848	1,017	15,912	683	22,464	1,179	14,040	509	13,104	410
	8	0.11	18,720	1,081	16,848	885	15,912	621	22,464	1,179	14,040	509	13,104	410
1.8	6	0.13	18,720	1,081	16,848	1,061	15,912	683	22,464	1,179	14,040	556	13,104	448
	8	0.13	18,720	1,081	16,848	973	15,912	621	22,464	1,179	14,040	556	13,104	448
2	4	0.2	15,120	1,057	13,608	943	12,852	661	18,144	1,257	11,340	493	10,584	399

【Note】 Please refer to P593

Recommended Cutting Data (General Type)

SPM200-SN2/SHM200-SN2

2 Flute, Standard Length

» Continuation

Micro Diameter Endmills for Deep Machining

Workpiece Material			P						N		H			
			Carbon Steel, Alloy Steel (180~250HB)		Alloy Steel, Tool Steel (25~35HRC)		PH,Ferrite, Martensite Steel (35~45HRC)		Copper, Copper Alloys		Hardened Steel (45~55HRC)		Hardened Steel (55~65HRC)	
Ratio to standard depth of cut(ap)			1.00		0.90		0.70		1.20		0.50		0.45	
Mill Dia. (mm)	Under Neck Length (mm)	ap	n r/min	Vf mm/min	n r/min	Vf mm/min	n r/min	Vf mm/min	n r/min	Vf mm/min	n r/min	Vf mm/min	n r/min	Vf mm/min
2	6	0.2	15,120	1,057	13,608	943	12,852	661	18,144	1,257	11,340	493	10,584	399
	8	0.14	15,120	1,057	13,608	943	12,852	661	18,144	1,257	11,340	493	10,584	399
	10	0.14	15,120	1,057	13,608	943	12,852	661	18,144	1,257	11,340	493	10,584	399
	12	0.1	13,608	862	12,247	776	11,567	595	16,330	1,034	10,206	444	9,526	358
	14	0.08	13,608	862	12,247	776	11,567	595	16,330	1,034	10,206	444	9,526	326
	16	0.08	13,608	823	12,247	776	11,567	541	16,330	941	10,206	404	9,526	326
	18	0.05	13,608	823	12,247	776	11,567	541	16,330	941	10,206	404	9,526	326
	20	0.05	13,608	784	12,247	706	11,567	541	16,330	941	10,206	404	9,526	326
	25	0.05	12,096	609	10,886	549	10,282	352	14,515	732	9,072	311	8,467	244
	30	0.03	12,096	609	10,886	549	10,282	352	14,515	732	9,072	311	8,467	244
	35	0.02	10,584	437	9,526	393	8,996	254	12,701	525	7,938	205	7,409	167
	40	0.01	10,584	437	9,526	393	8,996	254	12,701	525	7,938	205	7,409	167
50	0.005	9,072	266	8,165	239	7,711	155	10,886	320	6,804	125	6,350	101	
2.5	8	0.18	12,960	1,122	11,664	1,011	11,016	708	15,552	1,347	9,720	578	9,072	427
	12	0.18	12,960	1,122	11,664	1,011	11,016	644	15,552	1,134	9,720	529	9,072	388
	16	0.1	11,664	966	10,498	869	9,914	580	13,997	1,008	8,748	476	8,165	349
	20	0.1	11,664	840	10,498	756	9,914	580	13,997	1,008	8,748	476	8,165	349
	30	0.06	10,368	653	9,331	588	8,813	392	12,442	783	7,776	307	7,258	248
	40	0.03	9,072	469	8,165	422	7,711	282	10,886	563	6,804	221	6,350	178
50	0.01	9,072	469	8,165	422	7,711	282	10,886	563	6,804	221	6,350	178	
3	8	0.3	11,520	997	10,368	897	9,792	629	13,824	1,198	9,540	513	8,064	380
	12	0.21	11,520	997	10,368	897	9,792	629	13,824	1,198	9,540	513	8,064	380
	16	0.15	10,368	895	9,331	738	8,813	567	12,442	1,030	8,505	462	7,258	341
	20	0.12	10,368	820	9,331	738	8,813	567	12,442	896	8,505	462	7,258	341
	25	0.08	10,368	820	9,331	738	8,813	567	12,442	896	8,505	462	7,258	341
	30	0.08	10,368	746	9,331	671	8,813	567	12,442	896	8,505	462	7,258	312
	40	0.05	9,216	663	8,294	597	7,834	458	11,059	796	6,912	342	6,451	276
50	0.02	8,064	417	7,258	375	6,854	250	9,677	500	6,048	196	5,645	158	
4	12	0.4	8,460	1,692	7,614	1,372	7,191	1,222	10,350	2,070	6,345	812	5,922	655
	16	0.28	8,460	1,692	7,614	1,372	7,191	1,222	10,350	2,070	6,345	812	5,922	655
	20	0.28	7,614	1,523	6,853	1,234	6,472	1,100	9,315	1,863	5,711	731	5,330	590
	25	0.16	7,614	1,372	6,853	1,110	6,472	990	9,315	1,677	5,711	731	5,330	590

【Note】 Please refer to P593

Recommended Cutting Data (General Type)

SPM200-SN2/SHM200-SN2

2 Flute, Standard Length

Micro Diameter Endmills for Deep Machining

» Continuation

Workpiece Material			P						N		H			
			Carbon Steel, Alloy Steel (180~250HB)		Alloy Steel, Tool Steel (25~35HRC)		PH,Ferrite, Martensite Steel (35~45HRC)		Copper, Copper Alloys		Hardened Steel (45~55HRC)		Hardened Steel (55~65HRC)	
Ratio to standard depth of cut(ap)			1.00		0.90		0.70		1.20		0.50		0.45	
Mill Dia. (mm)	Under Neck Length (mm)	ap	n r/min	Vf mm/min	n r/min	Vf mm/min	n r/min	Vf mm/min	n r/min	Vf mm/min	n r/min	Vf mm/min	n r/min	Vf mm/min
4	30	0.16	7,614	1,372	6,853	1,110	6,472	990	9,315	1,677	5,711	731	5,330	590
	35	0.1	6,853	1,234	6,168	999	5,825	891	8,223	1,481	5,140	658	4,797	530
	40	0.1	6,853	1,234	6,168	999	5,825	891	8,223	1,481	5,140	658	4,797	530
	50	0.06	5,922	846	5,330	761	5,034	592	7,106	1,015	4,442	398	4,145	321
5	20	0.3	6,761	1,487	6,085	1,338	5,747	946	8,113	1,622	5,071	635	4,732	514
	25	0.3	6,084	1,216	5,476	1,094	5,171	851	7,301	1,459	4,563	572	4,259	462
	30	0.2	6,084	1,095	5,476	985	5,171	766	7,301	1,315	4,563	516	4,259	416
	40	0.15	5,476	986	4,928	887	4,654	690	6,571	1,184	4,107	464	3,833	374
	50	0.1	5,476	986	4,928	887	4,654	690	6,571	1,184	4,107	464	3,833	374
6	20	0.5	5,564	1,333	5,008	1,200	4,730	932	6,676	1,466	4,173	689	3,894	506
	30	0.4	5,058	1,211	4,552	1,091	4,299	848	6,070	1,332	3,794	626	3,541	460
	40	0.3	5,058	998	4,552	898	4,299	762	6,070	1,199	3,794	563	3,541	413
	50	0.2	4,500	887	4,050	798	3,825	621	5,400	981	3,375	464	3,150	341

[Note]

- For different materials, adjust the cutting depth (ap) according to the cutting depth factors in the above table. E.g. for hardened Steel (45~55HRC), $ap \times 0.5$.
- Use the appropriate coolant such as air cooling or emulsion for the work material and machining shape.
- In actual machining, the condition should be adjusted according to the machining shape, purpose and the machine type.
- If the rpm of the machine is lower than the data in the above table, the feed rate should also be lowered in the same ratio.

Recommended Cutting Data (High Precision)

SPM200-SN2/SHM200-SN2

2 Flute, Standard Length

Micro Diameter Endmills for Deep Machining

Workpiece Material			P						N		H			
			Carbon Steel, Alloy Steel (180~250HB)		Alloy Steel, Tool Steel (25~35HRC)		PH, Ferrite, Martensite Steel (35~45HRC)		Copper, Copper Alloys		Hardened Steel (45~55HRC)		Hardened Steel (55~65HRC)	
Ratio to standard depth of cut(ap)			1.00		0.90		0.70		1.20		0.50		0.45	
Mill Dia. (mm)	Under Neck Length (mm)	ap	n r/min	Vf mm/min	n r/min	Vf mm/min	n r/min	Vf mm/min	n r/min	Vf mm/min	n r/min	Vf mm/min	n r/min	Vf mm/min
0.1	0.3	0.006	50,000	350	45,000	299	43,740	218	50,000	350	38,475	160	36,045	130
	0.5	0.004	50,000	350	45,000	299	43,740	218	50,000	350	38,475	160	36,045	130
	1	0.003	50,000	318	43,740	271	39,330	198	50,000	318	34,650	146	32,445	116
0.2	0.5	0.015	40,500	401	36,450	361	34,425	254	45,000	446	30,375	189	28,350	152
	1	0.011	40,500	401	36,450	361	34,425	254	45,000	446	30,375	189	28,350	152
	1.5	0.006	36,450	330	32,805	297	30,983	228	43,740	397	27,338	170	25,515	137
	2	0.004	32,400	265	29,160	238	27,540	180	38,880	317	24,300	149	22,680	132
	3	0.002	32,400	238	29,160	214	27,540	161	38,880	285	24,300	149	22,680	120
0.3	1	0.021	36,000	408	32,400	367	30,600	257	43,200	490	27,000	216	25,200	174
	1.5	0.021	36,000	408	32,400	367	30,600	257	43,200	490	27,000	216	25,200	174
	2	0.012	32,400	336	29,160	302	27,540	231	38,880	403	24,300	173	22,680	140
	2.5	0.01	32,400	336	29,160	302	27,540	231	38,880	403	24,300	173	22,680	140
	3	0.008	32,400	336	29,160	302	27,540	231	38,880	403	24,300	162	22,680	131
0.4	1	0.04	28,800	572	25,920	514	24,480	361	34,560	686	21,600	267	20,160	217
	1.5	0.028	28,800	572	25,920	514	24,480	361	34,560	686	21,600	267	20,160	217
	2	0.028	28,800	572	25,920	514	24,480	361	34,560	686	21,600	267	20,160	217
	2.5	0.022	25,920	418	23,328	376	22,032	288	31,104	501	19,440	215	18,144	173
	3	0.016	25,920	418	23,328	376	22,032	288	31,104	501	19,440	215	18,144	173
	3.5	0.012	25,920	418	23,328	376	22,032	288	31,104	501	19,440	215	18,144	173
	4	0.01	25,920	418	23,328	376	22,032	288	31,104	501	19,440	215	18,144	173
	5	0.01	23,040	284	20,736	256	19,584	187	27,648	365	17,280	166	16,128	130
	6	0.006	23,040	284	20,736	256	19,584	187	27,648	365	17,280	166	16,128	130
	8	0.003	20,160	216	18,144	195	17,136	144	24,192	260	15,120	127	14,112	115
0.5	10	0.002	17,280	159	15,552	143	14,688	105	20,736	191	12,960	93	12,096	85
	1	0.05	28,800	572	25,920	514	24,480	401	34,560	686	21,600	269	20,160	217
	1.5	0.05	28,800	572	25,920	514	24,480	401	34,560	686	21,600	269	20,160	217
	2	0.035	28,800	572	25,920	514	24,480	401	34,560	686	21,600	269	20,160	217
	2.5	0.03	25,920	418	23,328	376	22,032	319	31,104	501	19,440	215	18,144	173
	3	0.02	25,920	418	23,328	376	22,032	319	31,104	501	19,440	215	18,144	173
	4	0.02	25,920	418	23,328	376	22,032	288	31,104	501	19,440	215	18,144	173
	5	0.013	25,920	418	23,328	376	22,032	288	31,104	501	19,440	215	18,144	173
6	0.013	23,040	325	20,736	292	19,584	187	27,648	390	17,280	166	16,128	130	

【Note】 Please refer to P598

Recommended Cutting Data (High Precision)

SPM200-SN2/SHM200-SN2

2 Flute, Standard Length

Micro Diameter Endmills for Deep Machining

» Continuation

Workpiece Material			P						N		H			
			Carbon Steel, Alloy Steel (180~250HB)		Alloy Steel, Tool Steel (25~35HRC)		PH,Ferrite, Martensite Steel (35~45HRC)		Copper, Copper Alloys		Hardened Steel (45~55HRC)		Hardened Steel (55~65HRC)	
Ratio to standard depth of cut(ap)			1.00		0.90		0.70		1.20		0.50		0.45	
Mill Dia. (mm)	Under Neck Length (mm)	ap	n r/min	Vf mm/min	n r/min	Vf mm/min	n r/min	Vf mm/min	n r/min	Vf mm/min	n r/min	Vf mm/min	n r/min	Vf mm/min
0.5	8	0.008	23,040	278	20,736	250	19,584	155	27,648	334	17,280	140	16,128	105
	10	0.004	20,160	216	18,144	194	17,136	109	24,192	259	15,120	95	14,112	71
0.6	2	0.042	28,800	816	25,920	734	24,480	515	34,560	980	21,600	384	20,160	310
	3	0.035	25,920	671	23,328	604	22,032	464	31,104	806	19,440	347	18,144	279
	4	0.024	25,920	671	23,328	604	22,032	464	31,104	806	19,440	347	18,144	279
	5	0.02	25,920	597	23,328	536	22,032	412	31,104	716	19,440	308	18,144	248
	6	0.015	25,920	597	23,328	536	22,032	412	31,104	716	19,440	308	18,144	248
	7	0.015	23,040	515	20,736	464	19,584	356	27,648	618	17,280	266	16,128	214
	8	0.015	23,040	464	20,736	418	19,584	267	27,648	536	17,280	236	16,128	185
	9	0.012	23,040	464	20,736	418	19,584	267	27,648	536	17,280	236	16,128	185
	10	0.009	23,040	464	20,736	418	19,584	267	27,648	536	17,280	236	16,128	185
	0.7	2	0.07	28,800	816	25,920	734	24,480	515	34,560	980	21,600	384	20,160
4		0.049	25,920	597	23,328	536	22,032	412	31,104	716	19,440	308	18,144	248
6		0.018	25,920	597	23,328	536	22,032	412	31,104	716	19,440	308	18,144	248
8		0.018	23,040	406	20,736	365	19,584	234	27,648	487	17,280	206	16,128	162
10		0.018	23,040	406	20,736	365	19,584	234	27,648	487	17,280	206	16,128	162
0.8	4	0.056	28,800	816	25,920	734	24,480	572	34,560	980	21,600	428	20,160	345
	6	0.032	25,920	597	23,328	536	22,032	516	31,104	716	19,440	385	18,144	311
	8	0.02	25,920	597	23,328	536	22,032	412	31,104	716	19,440	308	18,144	248
	10	0.02	23,040	406	20,736	365	19,584	234	27,648	487	17,280	206	16,128	162
	12	0.012	23,040	406	20,736	365	19,584	234	27,648	487	17,280	206	16,128	162
0.9	6	0.036	25,920	746	23,328	671	22,032	516	31,104	896	19,440	385	18,144	311
	8	0.023	25,920	671	23,328	671	22,032	516	31,104	896	19,440	385	18,144	311
	10	0.023	23,040	464	20,736	418	19,584	267	27,648	557	17,280	236	16,128	185
	12	0.023	23,040	406	20,736	373	19,584	267	27,648	487	17,280	236	16,128	185
1	2	0.09	25,920	1,098	23,328	988	22,032	842	31,104	1,319	19,440	629	18,144	507
	3	0.07	25,920	1,098	23,328	988	22,032	842	31,104	1,319	19,440	629	18,144	507
	4	0.065	25,920	1,098	23,328	988	22,032	842	31,104	1,319	19,440	629	18,144	507
	5	0.05	25,920	1,098	23,328	988	22,032	842	31,104	1,319	19,440	629	18,144	507
	6	0.035	23,328	907	20,995	816	19,829	696	27,994	1,148	17,496	519	16,330	376
	7	0.035	23,328	907	20,995	816	19,829	696	27,994	1,148	17,496	519	16,330	376
	8	0.035	23,328	907	20,995	816	19,829	696	27,994	1,088	17,496	519	16,330	376

【Note】 Please refer to P598

Recommended Cutting Data (High Precision)

SPM200-SN2/SHM200-SN2

2 Flute, Standard Length

Micro Diameter Endmills for Deep Machining

» Continuation

Workpiece Material			P						N		H			
			Carbon Steel, Alloy Steel (180~250HB)		Alloy Steel, Tool Steel (25~35HRC)		PH,Ferrite, Martensite Steel (35~45HRC)		Copper, Copper Alloys		Hardened Steel (45~55HRC)		Hardened Steel (55~65HRC)	
Ratio to standard depth of cut(ap)			1.00		0.90		0.70		1.20		0.50		0.45	
Mill Dia. (mm)	Under Neck Length (mm)	ap	n r/min	Vf mm/min	n r/min	Vf mm/min	n r/min	Vf mm/min	n r/min	Vf mm/min	n r/min	Vf mm/min	n r/min	Vf mm/min
1	9	0.03	23,328	907	20,995	816	19,829	626	27,994	1,088	17,496	415	16,330	335
	10	0.022	23,328	806	20,995	734	19,829	626	27,994	1,088	17,496	415	16,330	335
	12	0.022	20,736	626	18,662	564	17,626	361	24,883	752	15,552	319	14,515	250
	14	0.022	20,736	626	18,662	564	17,626	361	24,883	752	15,552	319	14,515	250
	16	0.012	20,736	536	18,662	483	17,626	342	24,883	644	15,552	268	14,515	203
	20	0.008	18,621	439	16,759	395	15,828	250	22,345	527	13,966	192	13,035	142
	25	0.005	15,750	341	14,175	307	13,388	194	18,900	410	11,813	149	11,025	110
1.2	6	0.084	23,040	980	20,736	882	19,584	684	27,648	1,175	17,280	462	16,128	373
	8	0.048	20,736	806	18,662	725	17,626	616	24,883	967	15,552	415	14,515	335
	10	0.03	20,736	806	18,662	725	17,626	616	24,883	967	15,552	415	14,515	335
	12	0.03	20,736	644	18,662	578	17,626	494	24,883	860	15,552	369	14,515	298
	16	0.02	18,432	636	16,589	501	15,667	439	22,118	763	13,824	328	12,902	265
1.4	6	0.1	20,160	857	18,144	771	17,136	541	24,192	1,029	15,120	404	14,112	325
	12	0.035	18,144	705	16,330	635	15,422	486	21,773	846	13,608	364	12,701	293
1.5	4	0.11	20,160	952	18,144	858	17,136	601	24,192	1,143	15,120	449	14,112	362
	6	0.11	20,160	857	18,144	779	17,136	601	24,192	1,029	15,120	449	14,112	362
	8	0.06	18,144	784	16,330	706	15,422	541	21,773	941	13,608	404	12,701	326
	10	0.06	18,144	705	16,330	635	15,422	541	21,773	941	13,608	404	12,701	326
	12	0.06	18,144	705	16,330	635	15,422	541	21,773	846	13,608	364	12,701	293
	14	0.038	18,144	705	16,330	635	15,422	541	21,773	846	13,608	364	12,701	293
	16	0.038	16,128	548	14,515	494	13,709	316	19,354	658	12,096	279	11,290	219
	18	0.038	16,128	548	14,515	494	13,709	316	19,354	658	12,096	279	11,290	219
	20	0.038	16,128	548	14,515	439	13,709	281	19,354	658	12,096	248	11,290	194
	25	0.023	12,096	352	10,886	282	10,282	200	14,515	423	9,072	157	8,467	119
	30	0.015	10,080	239	10,886	191	8,568	134	12,096	287	7,560	100	7,056	80
	35	0.01	10,080	212	10,886	167	8,568	134	12,096	256	7,560	100	7,056	80
	40	0.005	8,064	113	7,258	102	6,854	68	9,677	137	6,048	53	5,645	43
1.6	6	0.11	18,720	879	16,848	796	15,912	621	22,464	1,061	14,040	464	13,104	374
	8	0.11	18,720	879	16,848	796	15,912	559	22,464	1,061	14,040	464	13,104	374
1.8	6	0.13	18,720	897	16,848	796	15,912	621	22,464	1,061	14,040	464	13,104	374
	8	0.13	18,720	897	16,848	796	15,912	559	22,464	1,061	14,040	464	13,104	374
2	4	0.2	15,120	857	13,608	775	12,852	590	18,144	1,143	11,340	449	10,584	362

【Note】 Please refer to P598

Recommended Cutting Data (High Precision)

SPM200-SN2/SHM200-SN2

2 Flute, Standard Length

Micro Diameter Endmills for Deep Machining

» Continuation

Workpiece Material			P						N		H			
			Carbon Steel, Alloy Steel (180~250HB)		Alloy Steel, Tool Steel (25~35HRC)		PH,Ferrite, Martensite Steel (35~45HRC)		Copper, Copper Alloys		Hardened Steel (45~55HRC)		Hardened Steel (55~65HRC)	
Ratio to standard depth of cut(ap)			1.00		0.90		0.70		1.20		0.50		0.45	
Mill Dia. (mm)	Under Neck Length (mm)	ap	n r/min	Vf mm/min	n r/min	Vf mm/min	n r/min	Vf mm/min	n r/min	Vf mm/min	n r/min	Vf mm/min	n r/min	Vf mm/min
2	6	0.2	15,120	857	13,608	775	12,852	590	18,144	1,143	11,340	449	10,584	362
	8	0.14	15,120	857	13,608	775	12,852	590	18,144	1,143	11,340	449	10,584	362
	10	0.14	15,120	857	13,608	775	12,852	590	18,144	1,143	11,340	449	10,584	362
	12	0.08	13,608	784	12,247	706	11,567	531	16,330	941	10,206	404	9,526	326
	14	0.08	13,608	784	12,247	706	11,567	531	16,330	941	10,206	404	9,526	293
	16	0.08	13,608	705	12,247	636	11,567	486	16,330	846	10,206	383	9,526	293
	18	0.05	13,608	705	12,247	636	11,567	486	16,330	846	10,206	364	9,526	260
	20	0.05	13,608	626	12,247	564	11,567	432	16,330	799	10,206	323	9,526	260
	25	0.05	12,096	548	10,886	494	10,282	281	14,515	658	9,072	279	8,467	209
	30	0.03	12,096	487	10,886	439	10,282	246	14,515	585	9,072	248	8,467	194
	35	0.02	10,584	349	9,526	314	8,996	203	12,701	419	7,938	164	7,409	133
	40	0.01	10,584	306	9,527	275	8,996	177	12,701	367	7,938	143	7,409	116
50	0.005	9,072	212	8,165	167	7,711	108	10,886	256	6,804	87	6,350	70	
2.5	8	0.18	12,960	1,021	11,664	919	11,016	644	15,552	1,225	9,720	482	9,072	388
	12	0.18	12,960	918	11,664	840	11,016	580	15,552	1,021	9,720	468	9,072	348
	16	0.1	11,664	755	10,498	682	9,914	521	13,997	907	8,748	405	8,165	314
	20	0.1	11,664	715	10,498	640	9,914	464	13,997	756	8,748	405	8,165	279
	30	0.06	10,368	522	9,331	411	8,813	313	12,442	626	7,776	245	7,258	198
	40	0.03	9,072	328	8,165	295	7,711	225	10,886	393	6,804	176	6,350	142
3	50	0.01	9,072	304	8,165	274	7,711	183	10,886	338	6,804	154	6,350	124
	8	0.3	11,520	907	10,368	816	9,792	572	13,824	1,089	8,640	428	8,064	345
	12	0.21	11,520	907	10,368	816	9,792	572	13,824	1,089	8,640	428	8,064	345
	16	0.12	10,368	746	9,331	671	8,813	516	12,442	896	7,776	385	7,258	310
	20	0.12	10,368	708	9,331	635	8,813	516	12,442	806	7,776	385	7,258	310
	25	0.08	10,368	708	9,331	635	8,813	516	12,442	806	7,776	385	7,258	310
	30	0.08	10,368	597	9,331	541	8,813	516	12,442	716	7,776	385	7,258	279
4	40	0.05	9,216	464	8,294	418	7,834	320	11,059	556	6,912	274	6,451	221
	50	0.02	8,064	312	7,258	262	6,854	175	9,677	350	6,048	137	5,645	111
	12	0.4	8,460	1,523	7,614	1,233	7,191	1,100	10,350	1,863	6,345	730	5,922	589
	16	0.28	8,460	1,523	7,614	1,233	7,191	1,100	10,350	1,863	6,345	730	5,922	589
4	20	0.28	7,614	1,370	6,853	1,110	6,472	989	9,315	1,677	5,711	657	5,330	529
	25	0.16	7,614	1,233	6,853	998	6,472	891	9,315	1,508	5,711	657	5,330	529

【Note】 Please refer to P598

Recommended Cutting Data (High Precision)

SPM200-SN2/SHM200-SN2

2 Flute, Standard Length

» Continuation

Micro Diameter Endmills for Deep Machining

Workpiece Material			P						N		H			
			Carbon Steel, Alloy Steel (180~250HB)		Alloy Steel, Tool Steel (25~35HRC)		PH,Ferrite, Martensite Steel (35~45HRC)		Copper, Copper Alloys		Hardened Steel (45~55HRC)		Hardened Steel (55~65HRC)	
Ratio to standard depth of cut(ap)			1.00		0.90		0.70		1.20		0.50		0.45	
Mill Dia. (mm)	Under Neck Length (mm)	ap	n r/min	Vf mm/min	n r/min	Vf mm/min	n r/min	Vf mm/min	n r/min	Vf mm/min	n r/min	Vf mm/min	n r/min	Vf mm/min
4	30	0.16	7,614	1,233	6,853	998	6,472	792	9,315	1,508	5,711	584	5,330	529
	35	0.1	6,853	986	6,168	799	5,825	713	8,223	1,184	5,140	526	4,797	424
	40	0.1	6,853	863	6,168	699	5,825	624	8,223	1,036	5,140	460	4,797	371
	50	0.06	5,922	592	6,395	533	5,034	414	7,106	710	4,442	278	4,145	224
5	20	0.3	6,761	1,216	6,085	1,094	5,747	851	8,113	1,459	5,071	572	4,732	462
	25	0.3	6,084	1,094	5,476	985	5,171	765	7,301	1,312	4,563	514	4,259	415
	30	0.2	6,084	985	5,476	886	5,171	689	7,301	1,182	4,563	463	4,259	374
	40	0.15	5,476	788	4,928	709	4,654	552	6,571	947	4,107	371	3,833	299
	50	0.1	5,476	788	4,928	621	4,654	518	6,571	887	4,107	324	3,833	262
6	20	0.5	5,564	1,111	5,008	1,000	4,730	778	6,676	1,333	4,173	522	3,894	422
	30	0.4	5,058	1,010	4,552	909	4,299	707	6,070	1,211	3,794	474	3,541	383
	40	0.3	5,058	908	4,552	817	4,299	635	6,070	1,090	3,794	427	3,541	345
	50	0.2	4,500	735	4,050	662	3,825	572	5,400	883	3,375	384	3,150	311

【Note】

1. For different materials, adjust the cutting depth (ap) according to the cutting depth factors in the above table. E.g. for hardened Steel (45~55HRC), $ap \times 0.5$.
2. Use the appropriate coolant such as air cooling or emulsion for the work material and machining shape.
3. In actual machining, the condition should be adjusted according to the machining shape, purpose and the machine type.
4. If the rpm of the machine is lower than the data in the above table, the feed rate should also be lowered in the same ratio.

Recommended Cutting Data (General Type)

SPM200-RN2/SHM200-RN2

2 Flute, Corner Radius

Micro Diameter Endmills for Deep Machining

Workpiece Material				P						N		H			
				Carbon Steel, Alloy Steel (180~250HB)		Alloy Steel, Tool Steel (25~35HRC)		PH,Ferrite, Martensite Steel (35~45HRC)		Copper, Copper Alloys		Hardened Steel (45~55HRC)		Hardened Steel (55~65HRC)	
Ratio to standard depth of cut(ap)				1.00		0.90		0.80		1.20		0.65		0.60	
Mill Dia. (mm)	r (mm)	Under Neck Length (mm)	ap	n r/min	Vf mm/min	n r/min	Vf mm/min	n r/min	Vf mm/min	n r/min	Vf mm/min	n r/min	Vf mm/min	n r/min	Vf mm/min
0.2	0.02	0.5	0.016	45,000	830	40,500	746	38,250	635	45,000	830	33,750	498	31,500	407
		1	0.011	45,000	830	40,500	746	38,250	635	45,000	830	33,750	498	31,500	407
		2	0.007	37,800	697	36,450	671	34,425	572	45,000	728	30,375	448	28,350	365
	0.05	0.5	0.02	45,000	830	40,500	746	38,250	635	45,000	830	33,750	498	31,500	407
		1	0.014	45,000	830	40,500	746	38,250	635	45,000	830	33,750	498	31,500	407
		1.5	0.008	42,300	779	38,475	709	36,338	603	45,000	728	32,063	473	29,925	386
	2	0.008	37,800	697	36,450	671	34,425	572	45,000	728	30,375	448	28,350	365	
0.3	0.02	1	0.016	43,200	1,045	38,880	941	36,720	660	45,000	1,087	32,400	492	30,240	397
		2	0.011	34,992	774	31,493	697	29,743	535	40,500	898	26,244	399	24,494	321
		3	0.007	33,242	684	29,918	616	28,256	473	38,475	793	24,932	353	23,270	284
	0.05	1	0.021	43,200	1,045	38,880	941	36,720	660	45,000	1,087	32,400	492	30,240	397
		1.5	0.016	41,040	993	36,936	894	34,884	627	42,750	1,032	30,780	468	28,728	377
		2	0.012	34,992	774	31,493	697	29,743	535	40,500	898	26,244	399	24,494	321
	2.5	0.01	34,992	774	31,493	697	29,743	535	40,500	898	26,244	399	24,494	321	
	3	0.008	33,242	684	29,918	616	28,256	473	38,475	793	24,932	353	23,270	284	
0.4	0.02	1	0.016	34,470	929	31,104	836	29,030	714	41,472	1,115	25,920	558	24,053	457
		2	0.013	34,470	836	31,104	752	29,030	643	41,472	1,004	25,920	501	24,053	411
		3	0.01	26,393	584	23,793	527	22,208	449	31,725	702	19,828	351	18,401	288
		4	0.007	21,735	482	19,595	433	18,288	370	26,126	578	16,329	289	15,153	237
	0.05	1	0.025	34,470	929	31,104	836	29,030	714	41,472	1,115	25,920	558	24,053	457
		1.5	0.02	34,470	929	31,104	836	29,030	714	41,472	1,115	25,920	558	24,053	457
		2	0.016	34,470	836	31,104	752	29,030	643	41,472	1,004	25,920	501	24,053	411
		2.5	0.015	32,400	797	29,160	716	27,540	609	38,880	956	24,300	478	22,680	391
		3	0.014	26,393	584	23,793	527	22,208	449	31,725	702	19,828	351	18,401	288
		3.5	0.012	24,786	548	22,307	493	21,068	420	29,743	658	18,590	329	17,350	269
		4	0.008	21,735	482	19,595	433	18,288	370	26,126	578	16,329	289	15,153	237
	0.1	1	0.033	34,470	929	31,104	836	29,030	714	41,472	1,115	25,920	558	24,053	457
2		0.028	34,470	836	31,104	752	29,030	643	41,472	1,004	25,920	501	24,053	411	
3		0.016	26,393	584	23,793	527	22,208	449	31,725	702	19,828	351	18,401	288	
4		0.01	21,735	482	19,595	433	18,288	370	26,126	578	16,329	289	15,153	237	
0.5	0.02	1	0.016	34,470	929	31,104	836	29,030	714	41,472	1,115	25,920	558	24,053	457
		2	0.013	34,470	836	31,104	752	29,030	643	41,472	1,115	25,920	558	24,053	457

【Note】 Please refer to P609

Recommended Cutting Data (General Type)

SPM200-RN2/SHM200-RN2

2 Flute, Corner Radius

Micro Diameter Endmills for Deep Machining

» Continuation

Workpiece Material				P						N		H				
				Carbon Steel, Alloy Steel (180~250HB)		Alloy Steel, Tool Steel (25~35HRC)		PH,Ferrite, Martensite Steel (35~45HRC)		Copper, Copper Alloys		Hardened Steel (45~55HRC)		Hardened Steel (55~65HRC)		
Ratio to standard depth of cut(ap)				1.00		0.90		0.80		1.20		0.65		0.60		
Mill Dia. (mm)	r (mm)	Under Neck Length (mm)	ap	n r/min	Vf mm/min	n r/min	Vf mm/min	n r/min	Vf mm/min	n r/min	Vf mm/min	n r/min	Vf mm/min	n r/min	Vf mm/min	
0.5	0.02	3	0.01	27,994	755	25,195	675	23,794	571	33,593	900	20,995	426	19,596	343	
		4	0.008	24,883	671	22,395	599	21,151	507	29,860	800	18,662	378	17,419	305	
		6	0.006	19,354	500	17,419	449	16,450	288	23,225	599	14,515	254	13,548	200	
	0.05	1	0.03	34,470	929	31,104	836	29,030	714	41,472	1,115	25,920	558	24,053	457	
		2	0.023	34,470	929	31,104	836	29,030	714	41,472	1,115	25,920	558	24,053	457	
		3	0.017	27,994	755	25,195	675	23,794	571	33,593	900	20,995	426	19,596	343	
		4	0.017	24,883	671	22,395	599	21,151	507	29,860	800	18,662	378	17,419	305	
		5	0.011	21,773	588	19,596	525	18,507	444	26,127	700	16,330	331	15,241	267	
		6	0.008	19,354	500	17,419	449	16,450	288	23,225	599	14,515	254	13,548	200	
	0.1	1	0.035	34,470	929	31,104	836	29,030	714	41,472	1,115	25,920	558	24,053	457	
		2	0.03	34,470	929	31,104	836	29,030	714	41,472	1,115	25,920	558	24,053	457	
		3	0.02	27,994	755	25,195	675	23,794	571	33,593	900	20,995	426	19,596	343	
		4	0.02	24,883	671	22,395	599	21,151	507	29,860	800	18,662	378	17,419	305	
		5	0.013	21,773	588	19,596	525	18,507	444	26,127	700	16,330	331	15,241	267	
		6	0.013	19,354	500	17,419	449	16,450	288	23,225	599	14,515	254	13,548	200	
	0.6	0.02	2	0.016	34,470	1,310	31,104	1,182	29,030	892	41,472	1,576	25,920	697	24,053	572
			4	0.013	27,994	1,032	25,195	929	23,794	713	33,593	1,238	20,995	532	19,596	429
			6	0.01	21,773	803	19,596	723	18,507	554	26,127	963	16,330	414	15,241	334
0.05		2	0.028	34,470	1,310	31,104	1,182	29,030	892	41,472	1,576	25,920	697	24,053	572	
		4	0.019	27,994	1,032	25,195	929	23,794	713	33,593	1,238	20,995	532	19,596	429	
		6	0.012	21,773	803	19,596	723	18,507	554	26,127	963	16,330	414	15,241	334	
		8	0.01	20,684	762	18,616	687	17,582	527	24,821	915	15,513	393	14,479	317	
0.1		10	0.007	18,507	610	16,656	549	15,731	440	22,208	733	13,880	320	12,955	258	
		2	0.035	34,470	1,310	31,104	1,182	29,030	892	41,472	1,576	25,920	697	24,053	572	
		4	0.024	27,994	1,032	25,195	929	23,794	713	33,593	1,238	20,995	532	19,596	429	
		6	0.015	21,773	803	19,596	723	18,507	554	26,127	963	16,330	414	15,241	334	
		8	0.013	20,684	762	18,616	687	17,582	527	24,821	915	15,513	393	14,479	317	
0.7	0.05	10	0.009	18,507	610	16,656	549	15,731	440	22,208	733	13,880	320	12,955	258	
		4	0.024	27,994	1,032	25,195	929	23,794	713	33,593	1,238	20,995	532	19,596	429	
	0.1	6	0.015	21,773	803	19,596	723	18,507	554	26,127	963	16,330	414	15,241	334	
		8	0.013	20,684	762	18,616	687	17,582	527	24,821	915	15,513	393	14,479	317	
		10	0.009	18,507	610	16,656	549	15,731	440	22,208	733	13,880	320	12,955	258	
		6	0.018	21,773	803	19,596	723	18,507	554	26,127	963	16,330	414	15,241	334	

【Note】 Please refer to P609

Recommended Cutting Data (General Type)

SPM200-RN2/SHM200-RN2

2 Flute, Corner Radius

» Continuation

Micro Diameter Endmills for Deep Machining

Workpiece Material				P						N		H				
				Carbon Steel, Alloy Steel (180~250HB)		Alloy Steel, Tool Steel (25~35HRC)		PH, Ferrite, Martensite Steel (35~45HRC)		Copper, Copper Alloys		Hardened Steel (45~55HRC)		Hardened Steel (55~65HRC)		
Ratio to standard depth of cut (ap)				1.00		0.90		0.80		1.20		0.65		0.60		
Mill Dia. (mm)	r (mm)	Under Neck Length (mm)	ap	n r/min	Vf mm/min	n r/min	Vf mm/min	n r/min	Vf mm/min	n r/min	Vf mm/min	n r/min	Vf mm/min	n r/min	Vf mm/min	
0.8	0.02	4	0.016	36,000	1,328	32,400	1,194	30,600	1,015	43,200	1,592	27,000	797	25,200	651	
		6	0.013	27,540	914	24,786	823	23,409	777	33,048	1,096	20,655	609	19,278	498	
	0.05	4	0.026	36,000	1,328	32,400	1,194	30,600	1,015	43,200	1,592	27,000	797	25,200	651	
		6	0.015	27,540	914	24,786	823	23,409	777	33,048	1,096	20,655	609	19,278	498	
		8	0.012	22,032	680	19,829	612	18,727	578	26,438	815	16,524	454	15,422	370	
	0.1	12	0.01	19,829	569	17,846	512	16,854	483	23,794	683	14,872	379	13,880	310	
		4	0.032	36,000	1,328	32,400	1,194	30,600	1,015	43,200	1,592	27,000	797	25,200	651	
		6	0.019	27,540	914	24,786	823	23,409	777	33,048	1,096	20,655	609	19,278	498	
		8	0.015	22,032	680	19,829	612	18,727	578	26,438	815	16,524	454	15,422	370	
	0.2	12	0.012	19,829	569	17,846	512	16,854	483	23,794	683	14,872	379	13,880	310	
		4	0.056	36,000	1,328	32,400	1,194	30,600	1,015	43,200	1,592	27,000	797	25,200	651	
		6	0.032	27,540	914	24,786	823	23,409	777	33,048	1,096	20,655	609	19,278	498	
		8	0.018	22,032	680	19,829	612	18,727	578	26,438	815	16,524	454	15,422	370	
	1	0.02	12	0.015	19,829	569	17,846	512	16,854	483	23,794	683	14,872	379	13,880	310
			2	0.016	35,541	2,132	32,101	1,926	30,095	1,625	42,993	2,579	26,655	1,279	24,936	1,047
			4	0.013	32,400	1,941	29,160	1,747	27,540	1,485	38,880	2,329	24,300	1,165	22,680	951
6			0.01	26,244	1,415	26,369	1,581	22,307	1,202	31,493	1,698	19,683	943	18,371	770	
8			0.008	23,328	1,257	23,620	1,274	19,829	1,069	27,994	1,509	17,496	839	16,330	685	
10			0.006	20,412	1,101	20,995	1,132	17,350	935	24,494	1,320	15,309	734	14,288	599	
0.05		12	0.005	18,144	869	18,371	990	15,422	647	21,773	1,043	13,608	571	12,701	456	
		2	0.046	35,541	2,132	32,101	1,926	30,095	1,625	42,993	2,579	26,655	1,279	24,936	1,047	
		3	0.035	35,541	2,132	32,101	1,926	30,095	1,625	42,993	2,579	26,655	1,279	24,936	1,047	
		4	0.027	32,400	1,941	29,160	1,747	27,540	1,485	38,880	2,329	24,300	1,165	22,680	951	
		5	0.021	28,662	1,719	26,369	1,581	24,936	1,346	35,827	2,149	22,070	1,059	20,636	867	
		6	0.017	26,244	1,415	23,620	1,274	22,307	1,202	31,493	1,698	19,683	943	18,371	770	
		8	0.016	23,328	1,257	20,995	1,132	19,829	1,069	27,994	1,509	17,496	839	16,330	685	
		10	0.011	20,412	1,101	18,371	990	17,350	935	24,494	1,320	15,309	734	14,288	599	
		12	0.01	18,144	869	16,330	783	15,422	647	21,773	1,043	13,608	571	12,701	456	
		16	0.006	18,144	761	16,330	685	15,422	600	21,773	913	13,608	489	12,701	381	
20		0.004	13,608	571	12,247	514	11,567	450	16,330	685	10,206	367	9,526	285		
0.1		2	0.065	35,541	2,132	32,101	1,926	30,095	1,625	42,993	2,579	26,655	1,279	24,936	1,047	
		3	0.05	35,541	2,132	32,101	1,926	30,095	1,625	42,993	2,579	26,655	1,279	24,936	1,047	

【Note】 Please refer to P609

Recommended Cutting Data (General Type)

SPM200-RN2/SHM200-RN2

2 Flute, Corner Radius

» Continuation

Micro Diameter Endmills for Deep Machining

Workpiece Material				P						N		H				
				Carbon Steel, Alloy Steel (180~250HB)		Alloy Steel, Tool Steel (25~35HRC)		PH,Ferrite, Martensite Steel (35~45HRC)		Copper, Copper Alloys		Hardened Steel (45~55HRC)		Hardened Steel (55~65HRC)		
Ratio to standard depth of cut(ap)				1.00		0.90		0.80		1.20		0.65		0.60		
Mill Dia. (mm)	r (mm)	Under Neck Length (mm)	ap	n r/min	Vf mm/min	n r/min	Vf mm/min	n r/min	Vf mm/min	n r/min	Vf mm/min	n r/min	Vf mm/min	n r/min	Vf mm/min	
1	0.1	4	0.038	32,400	1,941	29,160	1,747	27,540	1,485	38,880	2,329	24,300	1,165	22,680	951	
		5	0.03	28,662	1,719	26,369	1,581	24,936	1,346	35,827	2,149	22,070	1,059	20,636	867	
		6	0.024	26,244	1,415	23,620	1,274	22,307	1,202	31,493	1,698	19,683	943	18,371	770	
		8	0.024	23,328	1,257	20,995	1,132	19,829	1,069	27,994	1,509	17,496	839	16,330	685	
		10	0.015	20,412	1,101	18,371	990	17,350	935	24,494	1,320	15,309	734	14,288	599	
		12	0.015	18,144	869	16,330	783	15,422	647	21,773	1,043	13,608	571	12,701	456	
		16	0.009	18,144	761	16,330	685	15,422	600	21,773	913	13,608	489	12,701	381	
		20	0.006	13,608	571	12,247	514	11,567	450	16,330	685	10,206	367	9,526	285	
	0.2	2	0.11	35,541	2,132	32,101	1,926	30,095	1,625	42,993	2,579	26,655	1,279	24,936	1,047	
		3	0.09	35,541	2,132	32,101	1,926	30,095	1,625	42,993	2,579	26,655	1,279	24,936	1,047	
		4	0.07	32,400	1,941	29,160	1,747	27,540	1,485	38,880	2,329	24,300	1,165	22,680	951	
		5	0.05	28,662	1,719	26,369	1,581	24,936	1,346	35,827	2,149	22,070	1,059	20,636	867	
		6	0.04	26,244	1,415	23,620	1,274	22,307	1,202	31,493	1,698	19,683	943	18,371	770	
		8	0.04	23,328	1,257	20,995	1,132	19,829	1,069	27,994	1,509	17,496	839	16,330	685	
		10	0.025	20,412	1,101	18,371	990	17,350	935	24,494	1,320	15,309	734	14,288	599	
		12	0.025	18,144	869	16,330	783	15,422	647	21,773	1,043	13,608	571	12,701	456	
	0.3	16	0.015	18,144	761	16,330	685	15,422	600	21,773	913	13,608	489	12,701	381	
		20	0.01	13,608	571	12,247	514	11,567	450	16,330	685	10,206	367	9,526	285	
		2	0.11	35,541	2,132	32,101	1,926	30,095	1,625	42,993	2,579	26,655	1,279	24,936	1,047	
		3	0.09	35,541	2,132	32,101	1,926	30,095	1,625	42,993	2,579	26,655	1,279	24,936	1,047	
		4	0.07	32,400	1,941	29,160	1,747	27,540	1,485	38,880	2,329	24,300	1,165	22,680	951	
		5	0.05	28,662	1,719	26,369	1,581	24,936	1,346	35,827	2,149	22,070	1,059	20,636	867	
		6	0.04	26,244	1,415	23,620	1,274	22,307	1,202	31,493	1,698	19,683	943	18,371	770	
		8	0.04	23,328	1,257	20,995	1,132	19,829	1,069	27,994	1,509	17,496	839	16,330	685	
	1.25	0.1	10	0.025	20,412	1,101	18,371	990	17,350	935	24,494	1,320	15,309	734	14,288	599
			15	0.01	18,144	761	16,330	685	15,422	600	21,773	913	13,608	489	12,701	381
			20	0.006	13,608	571	12,247	514	11,567	450	16,330	685	10,206	367	9,526	285

【Note】 Please refer to P609

Recommended Cutting Data (General Type)

SPM200-RN2/SHM200-RN2

2 Flute, Corner Radius

» Continuation

Micro Diameter Endmills for Deep Machining

Workpiece Material				P						N		H				
				Carbon Steel, Alloy Steel (180~250HB)		Alloy Steel, Tool Steel (25~35HRC)		PH,Ferrite, Martensite Steel (35~45HRC)		Copper, Copper Alloys		Hardened Steel (45~55HRC)		Hardened Steel (55~65HRC)		
Ratio to standard depth of cut(ap)				1.00		0.90		0.80		1.20		0.65		0.60		
Mill Dia. (mm)	r (mm)	Under Neck Length (mm)	ap	n r/min	Vf mm/min	n r/min	Vf mm/min	n r/min	Vf mm/min	n r/min	Vf mm/min	n r/min	Vf mm/min	n r/min	Vf mm/min	
1.25	0.2	5	0.05	28,662	1,719	26,369	1,581	24,936	1,346	35,827	2,149	22,070	1,059	20,636	867	
		10	0.025	23,328	1,257	18,371	990	17,350	935	24,494	1,320	15,309	734	14,288	599	
		15	0.016	18,144	761	16,330	685	15,422	600	21,773	913	13,608	489	12,701	381	
	0.3	20	0.01	13,608	571	12,247	514	11,567	450	16,330	685	10,206	367	9,526	285	
		5	0.05	28,662	1,719	26,369	1,581	24,936	1,346	35,827	2,149	22,070	1,059	20,636	867	
		10	0.025	23,328	1,257	18,371	990	17,350	935	24,494	1,320	15,309	734	14,288	599	
		15	0.016	18,144	761	16,330	685	15,422	600	21,773	913	13,608	489	12,701	381	
1.5	0.1	20	0.01	13,608	571	12,247	514	11,567	450	16,330	685	10,206	367	9,526	285	
		4	0.042	24,930	1,614	22,453	1,453	20,957	1,240	29,938	1,938	18,711	968	17,364	795	
		6	0.04	23,885	1,543	21,401	1,382	20,255	1,199	28,662	1,851	17,961	930	16,624	761	
		8	0.036	22,680	1,467	20,412	1,320	19,278	1,141	27,216	1,760	17,010	881	15,876	726	
		12	0.036	18,144	1,174	16,330	1,057	15,422	913	21,773	1,409	13,608	705	12,701	581	
		15	0.023	14,112	812	12,701	731	11,995	604	16,934	974	10,584	533	9,878	426	
	0.2	20	0.018	14,112	734	12,701	660	11,995	552	16,934	880	10,584	486	9,878	385	
		4	0.07	24,930	1,614	22,453	1,453	20,957	1,240	29,938	1,938	18,711	968	17,364	795	
		6	0.065	23,885	1,543	21,401	1,382	20,255	1,199	28,662	1,851	17,961	930	16,624	761	
		8	0.06	22,680	1,467	20,412	1,320	19,278	1,141	27,216	1,760	17,010	881	15,876	726	
		12	0.06	18,144	1,174	16,330	1,057	15,422	913	21,773	1,409	13,608	705	12,701	581	
		15	0.038	14,112	812	12,701	731	11,995	604	16,934	974	10,584	533	9,878	426	
		20	0.03	14,112	734	12,701	660	11,995	552	16,934	880	10,584	486	9,878	385	
		0.3	4	0.07	24,930	1,614	22,453	1,453	20,957	1,240	29,938	1,938	18,711	968	17,364	795
			6	0.065	23,885	1,543	21,401	1,382	20,255	1,199	28,662	1,851	17,961	930	16,624	761
			8	0.06	22,680	1,467	20,412	1,320	19,278	1,141	27,216	1,760	17,010	881	15,876	726
			12	0.06	18,144	1,174	16,330	1,057	15,422	913	21,773	1,409	13,608	705	12,701	581
			15	0.038	14,112	812	12,701	731	11,995	604	16,934	974	10,584	533	9,878	426
			20	0.03	14,112	734	12,701	660	11,995	552	16,934	880	10,584	486	9,878	385
			0.5	4	0.085	24,930	1,614	22,453	1,453	20,957	1,240	29,938	1,938	18,711	968	17,364
6	0.08			23,885	1,543	21,401	1,382	20,255	1,199	28,662	1,851	17,961	930	16,624	761	
8	0.07	22,680		1,467	20,412	1,320	19,278	1,141	27,216	1,760	17,010	881	15,876	726		
12	0.065	18,144		1,174	16,330	1,057	15,422	913	21,773	1,409	13,608	705	12,701	581		
15	0.045	14,112		812	12,701	731	11,995	604	16,934	974	10,584	533	9,878	426		
20	0.035	14,112		734	12,701	660	11,995	552	16,934	880	10,584	486	9,878	385		

【Note】 Please refer to P609

Recommended Cutting Data (General Type)

SPM200-RN2/SHM200-RN2

2 Flute, Corner Radius

» Continuation

Micro Diameter Endmills for Deep Machining

Workpiece Material				P						N		H			
				Carbon Steel, Alloy Steel (180~250HB)		Alloy Steel, Tool Steel (25~35HRC)		PH, Ferrite, Martensite Steel (35~45HRC)		Copper, Copper Alloys		Hardened Steel (45~55HRC)		Hardened Steel (55~65HRC)	
Ratio to standard depth of cut(ap)				1.00		0.90		0.80		1.20		0.65		0.60	
Mill Dia. (mm)	r (mm)	Under Neck Length (mm)	ap	n r/min	Vf mm/min	n r/min	Vf mm/min	n r/min	Vf mm/min	n r/min	Vf mm/min	n r/min	Vf mm/min	n r/min	Vf mm/min
1.75	0.1	5	0.04	23,885	1,543	21,401	1,382	20,255	1,199	28,662	1,851	17,961	930	16,624	761
		10	0.036	18,144	1,174	16,330	1,057	15,422	913	21,773	1,409	13,608	705	12,701	581
		15	0.023	14,112	812	12,701	731	11,995	604	16,934	974	10,584	533	9,878	426
		20	0.018	14,112	734	12,701	660	11,995	552	16,934	880	10,584	486	9,878	385
	0.2	5	0.065	23,885	1,543	21,401	1,382	20,255	1,199	28,662	1,851	17,961	930	16,624	761
		10	0.06	18,144	1,174	16,330	1,057	15,422	913	21,773	1,409	13,608	705	12,701	581
		15	0.038	14,112	812	12,701	731	11,995	604	16,934	974	10,584	533	9,878	426
		20	0.03	14,112	734	12,701	660	11,995	552	16,934	880	10,584	486	9,878	385
	0.3	5	0.065	23,885	1,543	21,401	1,382	20,255	1,199	28,662	1,851	17,961	930	16,624	761
		10	0.06	18,144	1,174	16,330	1,057	15,422	913	21,773	1,409	13,608	705	12,701	581
		15	0.038	14,112	812	12,701	731	11,995	604	16,934	974	10,584	533	9,878	426
		20	0.03	14,112	734	12,701	660	11,995	552	16,934	880	10,584	486	9,878	385
2	0.1	4	0.08	21,783	2,448	19,634	2,207	18,487	2,077	25,796	2,899	16,337	1,467	15,334	1,205
		6	0.07	20,790	2,336	18,711	2,102	17,672	1,985	24,948	2,803	15,593	1,401	14,553	1,144
		8	0.055	18,900	2,123	17,010	1,911	16,065	1,805	22,680	2,547	14,175	1,274	13,230	1,040
		12	0.03	15,309	1,548	13,778	1,393	13,013	1,316	18,371	1,857	11,482	1,031	10,716	842
		16	0.03	13,608	1,375	12,247	1,238	11,567	1,169	16,330	1,651	10,206	917	9,526	749
		20	0.025	11,907	1,203	10,716	1,084	10,121	1,023	14,288	1,445	8,931	721	8,335	588
		25	0.015	11,907	1,203	10,716	1,084	10,121	1,023	14,288	1,445	8,931	721	8,335	588
		30	0.01	11,312	1,144	10,181	1,029	9,615	972	13,574	1,373	8,483	685	7,918	559
	0.2	4	0.1	21,783	2,448	19,634	2,207	18,487	2,077	25,796	2,899	16,337	1,467	15,334	1,205
		6	0.08	20,790	2,336	18,711	2,102	17,672	1,985	24,948	2,803	15,593	1,401	14,553	1,144
		8	0.07	18,900	2,123	17,010	1,911	16,065	1,805	22,680	2,547	14,175	1,274	13,230	1,040
		12	0.04	15,309	1,548	13,778	1,393	13,013	1,316	18,371	1,857	11,482	1,031	10,716	842
		16	0.04	13,608	1,375	12,247	1,238	11,567	1,169	16,330	1,651	10,206	917	9,526	749
		20	0.035	11,907	1,203	10,716	1,084	10,121	1,023	14,288	1,445	8,931	721	8,335	588
		25	0.025	11,907	1,203	10,716	1,084	10,121	1,023	14,288	1,445	8,931	721	8,335	588
		30	0.017	11,312	1,144	10,181	1,029	9,615	972	13,574	1,373	8,483	685	7,918	559
0.3	4	0.13	21,783	2,448	19,634	2,207	18,487	2,077	25,796	2,899	16,337	1,467	15,334	1,205	
	6	0.11	20,790	2,336	18,711	2,102	17,672	1,985	24,948	2,803	15,593	1,401	14,553	1,144	
	8	0.09	18,900	2,123	17,010	1,911	16,065	1,805	22,680	2,547	14,175	1,274	13,230	1,040	
	12	0.06	15,309	1,548	13,778	1,393	13,013	1,316	18,371	1,857	11,482	1,031	10,716	842	

[Note] Please refer to P609

Recommended Cutting Data (General Type)

SPM200-RN2/SHM200-RN2

2 Flute, Corner Radius

» Continuation

Micro Diameter Endmills for Deep Machining

Workpiece Material				P						N		H				
				Carbon Steel, Alloy Steel (180~250HB)		Alloy Steel, Tool Steel (25~35HRC)		PH,Ferrite, Martensite Steel (35~45HRC)		Copper, Copper Alloys		Hardened Steel (45~55HRC)		Hardened Steel (55~65HRC)		
Ratio to standard depth of cut(ap)				1.00		0.90		0.80		1.20		0.65		0.60		
Mill Dia. (mm)	r (mm)	Under Neck Length (mm)	ap	n r/min	Vf mm/min	n r/min	Vf mm/min	n r/min	Vf mm/min	n r/min	Vf mm/min	n r/min	Vf mm/min	n r/min	Vf mm/min	
2	0.3	16	0.06	13,608	1,375	12,247	1,238	11,567	1,169	16,330	1,651	10,206	917	9,526	749	
		20	0.037	11,907	1,203	10,716	1,084	10,121	1,023	14,288	1,445	8,931	721	8,335	588	
		25	0.03	11,907	1,203	10,716	1,084	10,121	1,023	14,288	1,445	8,931	721	8,335	588	
		30	0.021	11,312	1,144	10,181	1,029	9,615	972	13,574	1,373	8,483	685	7,918	559	
	0.5	6	0.17	20,790	2,336	18,711	2,102	17,672	1,985	24,948	2,803	15,593	1,401	14,553	1,144	
		8	0.14	18,900	2,123	17,010	1,911	16,065	1,805	22,680	2,547	14,175	1,274	13,230	1,040	
		12	0.08	15,309	1,548	13,778	1,393	13,013	1,316	18,371	1,857	11,482	1,031	10,716	842	
		16	0.08	13,608	1,375	12,247	1,238	11,567	1,169	16,330	1,651	10,206	917	9,526	749	
		20	0.05	11,907	1,203	10,716	1,084	10,121	1,023	14,288	1,445	8,931	721	8,335	588	
		25	0.05	11,907	1,203	10,716	1,084	10,121	1,023	14,288	1,445	8,931	721	8,335	588	
	0.8	30	0.03	11,312	1,144	10,181	1,029	9,615	972	13,574	1,373	8,483	685	7,918	559	
		6	0.22	20,790	2,336	18,711	2,102	17,672	1,985	24,948	2,803	15,593	1,401	14,553	1,144	
		8	0.2	18,900	2,123	17,010	1,911	16,065	1,805	22,680	2,547	14,175	1,274	13,230	1,040	
		12	0.13	15,309	1,548	13,778	1,393	13,013	1,316	18,371	1,857	11,482	1,031	10,716	842	
		16	0.1	13,608	1,375	12,247	1,238	11,567	1,169	16,330	1,651	10,206	917	9,526	749	
		20	0.06	11,907	1,203	10,716	1,084	10,121	1,023	14,288	1,445	8,931	721	8,335	588	
	2.5	0.1	25	0.057	11,907	1,203	10,716	1,084	10,121	1,023	14,288	1,445	8,931	721	8,335	588
			30	0.045	11,312	1,144	10,181	1,029	9,615	972	13,574	1,373	8,483	685	7,918	559
			10	0.05	15,309	1,548	13,778	1,393	13,013	1,316	18,371	2,064	11,482	1,031	10,716	842
		0.2	20	0.03	11,907	1,203	10,716	1,084	10,121	1,023	14,288	1,605	8,931	721	8,335	588
			30	0.015	11,312	1,144	10,181	1,029	9,615	972	13,574	1,373	8,483	685	7,918	559
			10	0.07	15,309	1,548	13,778	1,393	13,013	1,316	18,371	2,064	11,482	1,031	10,716	842
		0.3	20	0.04	11,907	1,203	10,716	1,084	10,121	1,023	14,288	1,605	8,931	721	8,335	588
			30	0.025	11,312	1,144	10,181	1,029	9,615	972	13,574	1,373	8,483	685	7,918	559
10			0.09	15,309	1,548	13,778	1,393	13,013	1,316	18,371	2,064	11,482	1,031	10,716	842	
0.5		20	0.06	11,907	1,203	10,716	1,084	10,121	1,023	14,288	1,605	8,931	721	8,335	588	
		30	0.03	11,312	1,144	10,181	1,029	9,615	972	13,574	1,373	8,483	685	7,918	559	
		10	0.12	15,309	1,548	13,778	1,393	13,013	1,316	18,371	2,064	11,482	1,031	10,716	842	
0.5	20	0.08	11,907	1,203	10,716	1,084	10,121	1,023	14,288	1,605	8,931	721	8,335	588		
	30	0.05	11,312	1,144	10,181	1,029	9,615	972	13,574	1,373	8,483	685	7,918	559		
	10	0.12	15,309	1,548	13,778	1,393	13,013	1,316	18,371	2,064	11,482	1,031	10,716	842		
3	0.1	6	0.08	14,400	2,021	12,960	1,820	12,240	1,718	17,280	2,426	10,800	1,213	10,080	991	
		8	0.07	14,400	2,021	12,960	1,820	12,240	1,718	17,280	2,426	10,800	1,213	10,080	991	

【Note】 Please refer to P609

Recommended Cutting Data (General Type)

SPM200-RN2/SHM200-RN2

2 Flute, Corner Radius

» Continuation

Micro Diameter Endmills for Deep Machining

Workpiece Material				P						N		H			
				Carbon Steel, Alloy Steel (180~250HB)		Alloy Steel, Tool Steel (25~35HRC)		PH,Ferrite, Martensite Steel (35~45HRC)		Copper, Copper Alloys		Hardened Steel (45~55HRC)		Hardened Steel (55~65HRC)	
Ratio to standard depth of cut(ap)				1.00		0.90		0.80		1.20		0.65		0.60	
Mill Dia. (mm)	r (mm)	Under Neck Length (mm)	ap	n r/min	Vf mm/min	n r/min	Vf mm/min	n r/min	Vf mm/min	n r/min	Vf mm/min	n r/min	Vf mm/min	n r/min	Vf mm/min
3	0.1	12	0.05	14,400	2,021	12,960	1,820	12,240	1,718	17,280	2,426	10,800	1,213	10,080	991
		16	0.035	14,400	2,021	12,960	1,820	12,240	1,718	17,280	2,426	10,800	1,213	10,080	991
		18	0.035	12,898	1,811	11,464	1,609	10,987	1,543	15,287	2,146	9,554	1,074	9,076	893
		20	0.035	11,664	1,638	10,498	1,474	9,914	1,392	13,997	1,966	8,748	983	8,165	803
		30	0.027	9,072	1,143	8,165	1,029	7,711	971	10,886	1,372	6,804	694	6,350	559
		35	0.02	9,072	1,143	8,165	1,029	7,711	971	10,886	1,372	6,804	694	6,350	559
	0.2	6	0.1	14,400	2,021	12,960	1,820	12,240	1,718	17,280	2,426	10,800	1,213	10,080	991
		8	0.09	14,400	2,021	12,960	1,820	12,240	1,718	17,280	2,426	10,800	1,213	10,080	991
		12	0.07	14,400	2,021	12,960	1,820	12,240	1,718	17,280	2,426	10,800	1,213	10,080	991
		16	0.05	14,400	2,021	12,960	1,820	12,240	1,718	17,280	2,426	10,800	1,213	10,080	991
		18	0.05	12,898	1,811	11,464	1,609	10,987	1,543	15,287	2,146	9,554	1,074	9,076	893
		20	0.05	11,664	1,638	10,498	1,474	9,914	1,392	13,997	1,966	8,748	983	8,165	803
	0.3	6	0.145	14,400	2,021	12,960	1,820	12,240	1,718	17,280	2,426	10,800	1,213	10,080	991
		8	0.13	14,400	2,021	12,960	1,820	12,240	1,718	17,280	2,426	10,800	1,213	10,080	991
		12	0.1	14,400	2,021	12,960	1,820	12,240	1,718	17,280	2,426	10,800	1,213	10,080	991
		16	0.075	14,400	2,021	12,960	1,820	12,240	1,718	17,280	2,426	10,800	1,213	10,080	991
		18	0.075	12,898	1,811	11,464	1,609	10,987	1,543	15,287	2,146	9,554	1,074	9,076	893
		20	0.075	11,664	1,638	10,498	1,474	9,914	1,392	13,997	1,966	8,748	983	8,165	803
	0.5	6	0.06	9,072	1,143	8,165	1,029	7,711	971	10,886	1,372	6,804	694	6,350	559
		35	0.05	9,072	1,143	8,165	1,029	7,711	971	10,886	1,372	6,804	694	6,350	559
		8	0.18	14,400	2,021	12,960	1,820	12,240	1,718	17,280	2,426	10,800	1,213	10,080	991
		12	0.13	14,400	2,021	12,960	1,820	12,240	1,718	17,280	2,426	10,800	1,213	10,080	991
		16	0.1	14,400	2,021	12,960	1,820	12,240	1,718	17,280	2,426	10,800	1,213	10,080	991
		18	0.1	12,898	1,811	11,464	1,609	12,240	1,718	15,287	2,146	9,554	1,074	9,076	893
	1	20	0.1	11,664	1,638	10,498	1,474	9,914	1,392	13,997	1,966	8,748	983	8,165	803
		30	0.08	9,072	1,143	8,165	1,029	7,711	971	10,886	1,372	6,804	694	6,350	559
		35	0.065	9,072	1,143	8,165	1,029	7,711	971	10,886	1,372	6,804	694	6,350	559
		8	0.2	14,400	2,021	12,960	1,820	12,240	1,718	17,280	2,426	10,800	1,213	10,080	991
12		0.15	14,400	2,021	12,960	1,820	12,240	1,718	17,280	2,426	10,800	1,213	10,080	991	
16		0.12	14,400	2,021	12,960	1,820	12,240	1,718	17,280	2,426	10,800	1,213	10,080	991	

【Note】 Please refer to P609

Recommended Cutting Data (General Type)

SPM200-RN2/SHM200-RN2

2 Flute, Corner Radius

» Continuation

Micro Diameter Endmills for Deep Machining

Workpiece Material				P						N		H			
				Carbon Steel, Alloy Steel (180~250HB)		Alloy Steel, Tool Steel (25~35HRC)		PH,Ferrite, Martensite Steel (35~45HRC)		Copper, Copper Alloys		Hardened Steel (45~55HRC)		Hardened Steel (55~65HRC)	
Ratio to standard depth of cut(ap)				1.00		0.90		0.80		1.20		0.65		0.60	
Mill Dia. (mm)	r (mm)	Under Neck Length (mm)	ap	n r/min	Vf mm/min	n r/min	Vf mm/min	n r/min	Vf mm/min	n r/min	Vf mm/min	n r/min	Vf mm/min	n r/min	Vf mm/min
3	1	18	0.11	12,898	1,811	11,464	1,609	12,240	1,718	15,287	2,146	9,554	1,074	9,076	893
		20	0.11	11,664	1,638	10,498	1,474	9,914	1,392	13,997	1,966	8,748	983	8,165	803
		30	0.09	9,072	1,143	8,165	1,029	7,711	971	10,886	1,372	6,804	694	6,350	559
		35	0.075	9,072	1,143	8,165	1,029	7,711	971	10,886	1,372	6,804	694	6,350	559
4	0.1	8	0.08	12,420	2,160	11,178	1,944	10,557	1,836	14,904	2,592	9,315	1,296	8,694	1,058
		12	0.065	12,420	2,160	11,178	1,944	10,557	1,836	14,904	2,592	9,315	1,296	8,694	1,058
		16	0.06	10,301	1,791	9,064	1,576	8,652	1,504	12,360	2,149	7,416	1,031	7,004	852
		20	0.055	10,301	1,791	9,064	1,576	8,652	1,504	12,360	2,149	7,416	1,031	7,004	852
		30	0.045	8,239	1,290	7,415	1,161	7,003	1,096	9,887	1,547	6,179	774	5,767	632
		35	0.04	8,239	1,290	7,415	1,161	7,003	1,096	9,887	1,547	6,179	774	5,767	632
		45	0.03	6,592	825	5,933	743	5,603	702	7,910	990	4,945	499	4,614	401
	0.2	8	0.16	12,420	2,160	11,178	1,944	10,557	1,836	14,904	2,592	9,315	1,296	8,694	1,058
		12	0.14	12,420	2,160	11,178	1,944	10,557	1,836	14,904	2,592	9,315	1,296	8,694	1,058
		16	0.13	10,301	1,791	9,064	1,576	8,652	1,504	12,360	2,149	7,416	1,031	7,004	852
		20	0.11	10,301	1,791	9,064	1,576	8,652	1,504	12,360	2,149	7,416	1,031	7,004	852
		30	0.1	8,239	1,290	7,415	1,161	7,003	1,096	9,887	1,547	6,179	774	5,767	632
		35	0.08	8,239	1,290	7,415	1,161	7,003	1,096	9,887	1,547	6,179	774	5,767	632
		45	0.06	6,592	825	5,933	743	5,603	702	7,910	990	4,945	499	4,614	401
	0.3	8	0.24	12,420	2,160	11,178	1,944	10,557	1,836	14,904	2,592	9,315	1,296	8,694	1,058
		12	0.22	12,420	2,160	11,178	1,944	10,557	1,836	14,904	2,592	9,315	1,296	8,694	1,058
		16	0.2	10,301	1,791	9,064	1,576	8,652	1,504	12,360	2,149	7,416	1,031	7,004	852
		20	0.18	10,301	1,791	9,064	1,576	8,652	1,504	12,360	2,149	7,416	1,031	7,004	852
		30	0.16	8,239	1,290	7,415	1,161	7,003	1,096	9,887	1,547	6,179	774	5,767	632
		35	0.14	8,239	1,290	7,415	1,161	7,003	1,096	9,887	1,547	6,179	774	5,767	632
		45	0.12	6,592	825	5,933	743	5,603	702	7,910	990	4,945	499	4,614	401
	0.5	12	0.35	12,420	2,160	11,178	1,944	10,557	1,836	14,904	2,592	9,315	1,296	8,694	1,058
		16	0.25	10,301	1,791	9,064	1,576	8,652	1,504	12,360	2,149	7,416	1,031	7,004	852
		20	0.2	10,301	1,791	9,064	1,576	8,652	1,504	12,360	2,149	7,416	1,031	7,004	852
30		0.15	8,239	1,290	7,415	1,161	7,003	1,096	9,887	1,547	6,179	774	5,767	632	
35		0.1	8,239	1,290	7,415	1,161	7,003	1,096	9,887	1,547	6,179	774	5,767	632	
45		0.05	6,592	825	5,933	743	5,603	702	7,910	990	4,945	499	4,614	401	

【Note】 Please refer to P609

Recommended Cutting Data (General Type)

SPM200-RN2/SHM200-RN2

2 Flute, Corner Radius

» Continuation

Micro Diameter Endmills for Deep Machining

Workpiece Material				P						N		H				
				Carbon Steel, Alloy Steel (180~250HB)		Alloy Steel, Tool Steel (25~35HRC)		PH,Ferrite, Martensite Steel (35~45HRC)		Copper, Copper Alloys		Hardened Steel (45~55HRC)		Hardened Steel (55~65HRC)		
Ratio to standard depth of cut(ap)				1.00		0.90		0.80		1.20		0.65		0.60		
Mill Dia. (mm)	r (mm)	Under Neck Length (mm)	ap	n r/min	Vf mm/min	n r/min	Vf mm/min	n r/min	Vf mm/min	n r/min	Vf mm/min	n r/min	Vf mm/min	n r/min	Vf mm/min	
4	1	12	0.4	12,420	2,160	11,178	1,944	10,557	1,836	14,904	2,592	9,315	1,296	8,694	1,058	
		16	0.29	10,301	1,791	9,064	1,576	8,652	1,504	12,360	2,149	7,416	1,031	7,004	852	
		20	0.23	10,301	1,791	9,064	1,576	8,652	1,504	12,360	2,149	7,416	1,031	7,004	852	
		30	0.17	8,239	1,290	7,415	1,161	7,003	1,096	9,887	1,547	6,179	774	5,767	632	
		35	0.12	8,239	1,290	7,415	1,161	7,003	1,096	9,887	1,547	6,179	774	5,767	632	
		45	0.06	6,592	825	5,933	743	5,603	702	7,910	990	4,945	499	4,614	401	
5	0.1	20	0.08	9,885	2,149	8,896	1,934	8,402	1,826	11,861	2,579	7,413	1,290	6,919	1,053	
		40	0.06	8,901	1,733	8,011	1,561	7,566	1,473	10,681	2,081	6,676	1,040	6,231	850	
	0.2	20	0.16	9,885	2,149	8,896	1,934	8,402	1,826	11,861	2,579	7,413	1,290	6,919	1,053	
		40	0.13	8,901	1,733	8,011	1,561	7,566	1,473	10,681	2,081	6,676	1,040	6,231	850	
	0.3	20	0.24	9,885	2,149	8,896	1,934	8,402	1,826	11,861	2,579	7,413	1,290	6,919	1,053	
		40	0.2	8,901	1,733	8,011	1,561	7,566	1,473	10,681	2,081	6,676	1,040	6,231	850	
	0.5	20	0.35	9,885	2,149	8,896	1,934	8,402	1,826	11,861	2,579	7,413	1,290	6,919	1,053	
		40	0.135	8,901	1,733	8,011	1,561	7,566	1,473	10,681	2,081	6,676	1,040	6,231	850	
	1	20	0.4	9,885	2,149	8,896	1,934	8,402	1,826	11,861	2,579	7,413	1,290	6,919	1,053	
		40	0.15	8,901	1,733	8,011	1,561	7,566	1,473	10,681	2,081	6,676	1,040	6,231	850	
	6	0.1	12	0.08	8,239	2,149	7,415	1,934	7,003	1,827	9,887	2,579	6,179	1,290	5,767	1,053
			18	0.065	8,239	2,149	7,415	1,934	7,003	1,827	9,887	2,579	6,179	1,290	5,767	1,053
24			0.06	8,239	2,149	7,415	1,934	7,003	1,827	9,887	2,579	6,179	1,290	5,767	1,053	
35			0.05	7,411	1,740	6,670	1,566	6,299	1,479	8,893	2,088	5,558	1,044	5,188	852	
55			0.04	5,765	1,354	5,189	1,219	4,901	1,150	6,918	1,625	4,325	812	4,036	663	
12			0.16	8,239	2,149	7,415	1,934	7,003	1,827	9,887	2,579	6,179	1,290	5,767	1,053	
0.2		18	0.14	8,239	2,149	7,415	1,934	7,003	1,827	9,887	2,579	6,179	1,290	5,767	1,053	
		24	0.13	8,239	2,149	7,415	1,934	7,003	1,827	9,887	2,579	6,179	1,290	5,767	1,053	
		35	0.11	7,411	1,740	6,670	1,566	6,299	1,479	8,893	2,088	5,558	1,044	5,188	852	
		55	0.08	5,765	1,354	5,189	1,219	4,901	1,150	6,918	1,625	4,325	812	4,036	663	
		12	0.24	8,239	2,149	7,415	1,934	7,003	1,827	9,887	2,579	6,179	1,290	5,767	1,053	
		18	0.22	8,239	2,149	7,415	1,934	7,003	1,827	9,887	2,579	6,179	1,290	5,767	1,053	
0.3		24	0.2	8,239	2,149	7,415	1,934	7,003	1,827	9,887	2,579	6,179	1,290	5,767	1,053	
		35	0.18	7,411	1,740	6,670	1,566	6,299	1,479	8,893	2,088	5,558	1,044	5,188	852	
		55	0.14	5,765	1,354	5,189	1,219	4,901	1,150	6,918	1,625	4,325	812	4,036	663	

[Note] Please refer to P609

Recommended Cutting Data (General Type)

SPM200-RN2/SHM200-RN2

2 Flute, Corner Radius

» Continuation

Micro Diameter Endmills for Deep Machining

Workpiece Material				P						N		H			
				Carbon Steel, Alloy Steel (180~250HB)		Alloy Steel, Tool Steel (25~35HRC)		PH, Ferrite, Martensite Steel (35~45HRC)		Copper, Copper Alloys		Hardened Steel (45~55HRC)		Hardened Steel (55~65HRC)	
Ratio to standard depth of cut(ap)				1.00		0.90		0.80		1.20		0.65		0.60	
Mill Dia. (mm)	r (mm)	Under Neck Length (mm)	ap	n r/min	Vf mm/min	n r/min	Vf mm/min	n r/min	Vf mm/min	n r/min	Vf mm/min	n r/min	Vf mm/min	n r/min	Vf mm/min
6	0.5	18	0.35	8,239	2,149	7,415	1,934	7,003	1,827	9,887	2,579	6,179	1,290	5,767	1,053
		24	0.29	8,239	2,149	7,415	1,934	7,003	1,827	9,887	2,579	6,179	1,290	5,767	1,053
		35	0.24	7,411	1,740	6,670	1,566	6,299	1,479	8,893	2,088	5,558	1,044	5,188	852
		55	0.165	5,765	1,354	5,189	1,219	4,901	1,150	6,918	1,625	4,325	812	4,036	663
	1	18	0.4	8,239	2,149	7,415	1,934	7,003	1,827	9,887	2,579	6,179	1,290	5,767	1,053
		24	0.35	8,239	2,149	7,415	1,934	7,003	1,827	9,887	2,579	6,179	1,290	5,767	1,053
		35	0.28	7,411	1,740	6,670	1,566	6,299	1,479	8,893	2,088	5,558	1,044	5,188	852
		55	0.2	5,765	1,354	5,189	1,219	4,901	1,150	6,918	1,625	4,325	812	4,036	663

【Note】

- For different materials, adjust the cutting depth (ap) according to the cutting depth factors in the above table. E.g. for hardened Steel (45~55HRC), $ap \times 0.5$.
- Use the appropriate coolant such as air cooling or emulsion for the work material and machining shape.
- In actual machining, the condition should be adjusted according to the machining shape, purpose and the machine type.
- If the rpm of the machine is lower than the data in the above table, the feed rate should also be lowered in the same ratio.

Recommended Cutting Data (High Precision)

SPM200-RN2/SHM200-RN2

2 Flute, Corner Radius

Micro Diameter Endmills for Deep Machining

Workpiece Material				P						N		H			
				Carbon Steel, Alloy Steel (180~250HB)		Alloy Steel, Tool Steel (25~35HRC)		PH,Ferrite, Martensite Steel (35~45HRC)		Copper, Copper Alloys		Hardened Steel (45~55HRC)		Hardened Steel (55~65HRC)	
Ratio to standard depth of cut(ap)				1.00		0.90		0.80		1.20		0.65		0.60	
Mill Dia. (mm)	r (mm)	Under Neck Length (mm)	ap	n r/min	Vf mm/min	n r/min	Vf mm/min	n r/min	Vf mm/min	n r/min	Vf mm/min	n r/min	Vf mm/min	n r/min	Vf mm/min
0.2	0.02	0.5	0.016	45,000	232	45,000	207	45,000	185	45,000	276	45,000	162	45,000	144
		1	0.011	45,000	232	45,000	207	45,000	185	45,000	276	45,000	162	45,000	144
		2	0.007	37,800	182	34,020	163	33,030	158	45,000	221	33,030	146	33,030	132
	0.05	0.5	0.02	45,000	232	45,000	207	45,000	185	45,000	276	45,000	162	45,000	144
		1	0.014	45,000	232	45,000	207	45,000	185	45,000	276	45,000	162	45,000	144
		1.5	0.008	45,000	216	43,740	201	41,310	182	45,000	248	41,310	153	41,310	138
		2	0.008	37,800	182	34,020	163	33,030	158	45,000	221	33,030	146	33,030	132
0.3	0.02	1	0.016	45,000	527	45,000	464	45,000	410	45,000	626	45,000	302	45,000	288
		2	0.011	40,500	477	40,500	414	40,500	378	40,500	558	40,500	270	40,500	261
		3	0.007	31,500	371	31,500	322	31,500	293	36,000	454	27,000	180	27,000	175
	0.05	1	0.021	45,000	527	45,000	464	45,000	410	45,000	626	45,000	302	45,000	288
		1.5	0.016	45,000	527	40,500	464	40,500	410	45,000	626	40,500	302	40,500	288
		2	0.012	40,500	477	40,500	414	40,500	378	40,500	558	40,500	270	40,500	261
		2.5	0.01	36,000	424	36,000	368	36,000	336	36,000	496	36,000	240	36,000	232
3	0.008	31,500	371	31,500	322	31,500	293	36,000	454	27,000	180	27,000	175		
0.4	0.02	1	0.016	45,000	522	45,000	466	45,000	415	45,000	622	36,000	288	32,400	243
		2	0.013	40,500	468	40,500	423	40,500	369	40,500	558	32,400	261	30,600	216
		3	0.01	36,000	369	36,000	333	36,000	297	36,000	432	29,520	216	23,040	180
		4	0.007	27,000	288	27,000	252	27,000	225	27,000	333	19,440	144	17,280	135
	0.05	1	0.025	45,000	522	45,000	466	45,000	415	45,000	622	36,000	288	32,400	243
		1.5	0.02	45,000	522	45,000	466	45,000	415	45,000	622	36,000	288	32,400	243
		2	0.016	40,500	468	40,500	423	40,500	369	40,500	558	32,400	261	30,600	216
		2.5	0.015	36,450	432	36,450	360	36,450	333	36,450	504	30,060	243	27,540	198
		3	0.014	36,000	369	36,000	333	36,000	297	36,000	432	29,520	216	23,040	180
		3.5	0.012	32,400	342	32,400	288	32,400	270	32,400	378	26,460	180	20,628	162
		4	0.008	27,000	288	27,000	252	27,000	225	27,000	333	19,440	144	17,280	135
	0.1	1	0.033	45,000	522	45,000	466	45,000	415	45,000	622	36,000	288	32,400	243
		2	0.028	40,500	468	40,500	423	40,500	369	40,500	558	32,400	261	30,600	216
		3	0.016	36,000	369	36,000	333	36,000	297	36,000	432	29,520	216	23,040	180
4		0.01	27,000	288	27,000	252	27,000	225	27,000	333	19,440	144	17,280	135	
0.5	0.02	1	0.016	45,000	808	45,000	680	36,000	418	45,000	963	27,000	340	25,200	284
		2	0.013	45,000	808	45,000	680	36,000	418	45,000	963	27,000	340	25,200	284

【Note】 Please refer to P620

Recommended Cutting Data (High Precision)

SPM200-RN2/SHM200-RN2

2 Flute, Corner Radius

Micro Diameter Endmills for Deep Machining

» Continuation

Workpiece Material				P						N		H				
				Carbon Steel, Alloy Steel (180~250HB)		Alloy Steel, Tool Steel (25~35HRC)		PH,Ferrite, Martensite Steel (35~45HRC)		Copper, Copper Alloys		Hardened Steel (45~55HRC)		Hardened Steel (55~65HRC)		
Ratio to standard depth of cut(ap)				1.00		0.90		0.80		1.20		0.65		0.60		
Mill Dia. (mm)	r (mm)	Under Neck Length (mm)	ap	n r/min	Vf mm/min	n r/min	Vf mm/min	n r/min	Vf mm/min	n r/min	Vf mm/min	n r/min	Vf mm/min	n r/min	Vf mm/min	
0.5	0.02	3	0.01	40,500	729	40,500	616	32,400	373	40,500	864	24,300	284	22,050	235	
		4	0.008	36,000	648	36,000	543	28,800	340	36,000	765	21,600	251	18,000	211	
		6	0.006	25,920	432	21,600	342	17,460	234	27,000	513	16,200	225	13,500	180	
	0.05	1	0.03	45,000	808	45,000	680	36,000	418	45,000	963	27,000	340	25,200	284	
		2	0.023	45,000	808	45,000	680	36,000	418	45,000	963	27,000	340	25,200	284	
		3	0.017	40,500	729	40,500	616	32,400	373	40,500	864	24,300	284	22,050	235	
		4	0.017	36,000	648	36,000	543	28,800	340	36,000	765	21,600	251	18,000	211	
		5	0.011	25,920	486	21,600	342	17,460	252	27,000	576	16,200	225	13,500	180	
		6	0.008	25,920	432	21,600	342	17,460	234	27,000	513	16,200	225	13,500	180	
	0.1	1	0.035	45,000	808	45,000	680	36,000	418	45,000	963	27,000	340	25,200	284	
		2	0.03	45,000	808	45,000	680	36,000	418	45,000	963	27,000	340	25,200	284	
		3	0.02	40,500	729	40,500	616	32,400	373	40,500	864	24,300	284	22,050	235	
		4	0.02	36,000	648	36,000	543	28,800	340	36,000	765	21,600	251	18,000	211	
		5	0.013	25,920	486	21,600	342	17,460	252	27,000	576	16,200	225	13,500	180	
		6	0.013	25,920	432	21,600	342	17,460	234	27,000	513	16,200	225	13,500	180	
	0.6	0.02	2	0.016	45,000	1,043	42,120	828	34,047	540	45,000	1,242	25,380	351	20,700	288
			4	0.013	36,000	747	31,050	558	25,020	396	36,000	882	21,240	252	18,900	207
			6	0.01	21,600	441	18,000	324	16,200	270	27,000	522	16,020	216	13,500	189
0.05		2	0.028	45,000	1,043	42,120	828	34,047	540	45,000	1,242	25,380	351	20,700	288	
		4	0.019	36,000	747	31,050	558	25,020	396	36,000	882	21,240	252	18,900	207	
		6	0.012	21,600	441	18,000	324	16,200	270	27,000	522	16,020	216	13,500	189	
		8	0.01	21,600	419	18,000	308	16,200	257	27,000	496	16,020	205	13,500	180	
0.1		10	0.007	21,600	406	18,000	298	16,200	248	27,000	481	16,020	199	13,500	174	
		2	0.035	45,000	1,043	42,120	828	34,047	540	45,000	1,242	25,380	351	20,700	288	
		4	0.024	36,000	747	31,050	558	25,020	396	36,000	882	21,240	252	18,900	207	
		6	0.015	21,600	441	18,000	324	16,200	270	27,000	522	16,020	216	13,500	189	
		8	0.013	21,600	419	18,000	308	16,200	257	27,000	496	16,020	205	13,500	180	
10	0.009	21,600	406	18,000	298	16,200	248	27,000	481	16,020	199	13,500	174			
0.7	0.05	4	0.024	36,000	747	31,050	558	25,020	396	36,000	882	21,240	252	18,900	207	
		6	0.015	21,600	441	18,000	324	16,200	270	27,000	522	16,020	216	13,500	189	
	0.1	4	0.029	36,000	747	31,050	558	25,020	396	36,000	882	21,240	252	18,900	207	
		6	0.018	21,600	441	18,000	324	16,200	270	27,000	522	16,020	216	13,500	189	

【Note】 Please refer to P620

Recommended Cutting Data (High Precision)

SPM200-RN2/SHM200-RN2

2 Flute, Corner Radius

» Continuation

Micro Diameter Endmills for Deep Machining

Workpiece Material				P						N		H			
				Carbon Steel, Alloy Steel (180~250HB)		Alloy Steel, Tool Steel (25~35HRC)		PH,Ferrite, Martensite Steel (35~45HRC)		Copper, Copper Alloys		Hardened Steel (45~55HRC)		Hardened Steel (55~65HRC)	
Ratio to standard depth of cut(ap)				1.00		0.90		0.80		1.20		0.65		0.60	
Mill Dia. (mm)	r (mm)	Under Neck Length (mm)	ap	n r/min	Vf mm/min	n r/min	Vf mm/min	n r/min	Vf mm/min	n r/min	Vf mm/min	n r/min	Vf mm/min	n r/min	Vf mm/min
0.8	0.02	4	0.016	43,200	992	32,400	675	25,200	466	45,000	1,181	18,000	288	18,000	259
		6	0.013	34,830	720	23,400	477	22,500	415	36,000	855	16,200	259	16,200	230
	0.05	4	0.026	43,200	992	32,400	675	25,200	466	45,000	1,181	18,000	288	18,000	259
		6	0.015	34,830	720	23,400	477	22,500	415	36,000	855	16,200	259	16,200	230
		8	0.012	26,123	540	18,720	382	18,000	332	27,000	642	14,580	233	14,580	207
	0.1	12	0.01	26,123	513	18,720	363	18,000	315	27,000	609	14,580	221	14,580	197
		4	0.032	43,200	992	32,400	675	25,200	466	45,000	1,181	18,000	288	18,000	259
		6	0.019	34,830	720	23,400	477	22,500	415	36,000	855	16,200	259	16,200	230
		8	0.015	26,123	540	18,720	382	18,000	332	27,000	642	14,580	233	14,580	207
	0.2	12	0.012	26,123	513	18,720	363	18,000	315	27,000	609	14,580	221	14,580	197
		4	0.056	43,200	992	32,400	675	25,200	466	45,000	1,181	18,000	288	18,000	259
		6	0.032	34,830	720	23,400	477	22,500	415	36,000	855	16,200	259	16,200	230
8		0.018	26,123	540	18,720	382	18,000	332	27,000	642	14,580	233	14,580	207	
1	0.02	12	0.015	26,123	513	18,720	363	18,000	315	27,000	609	14,580	221	14,580	197
		2	0.016	32,101	1,412	28,868	1,270	27,265	1,091	38,408	1,689	24,057	866	22,453	718
		4	0.013	29,160	1,223	26,244	1,101	24,786	935	34,992	1,467	21,870	734	20,412	599
		6	0.01	23,620	891	21,258	802	20,076	758	28,344	1,070	17,715	594	16,534	485
		8	0.008	20,995	792	18,896	713	17,846	673	25,195	950	15,746	528	14,697	431
		10	0.006	18,371	693	16,534	624	15,615	590	19,596	832	13,778	463	12,859	377
	0.05	12	0.005	16,330	548	14,697	493	13,880	408	19,596	657	12,247	359	11,431	288
		2	0.046	32,101	1,412	28,868	1,270	27,229	1,089	38,408	1,689	24,057	866	22,453	718
		3	0.035	30,618	1,316	27,556	1,185	27,265	1,091	36,716	1,579	22,964	780	21,433	643
		4	0.027	29,160	1,223	26,244	1,101	26,025	1,015	34,992	1,467	21,870	734	20,412	599
		5	0.021	25,981	1,039	23,384	935	24,786	935	31,242	1,249	19,486	654	18,187	535
		6	0.017	23,620	891	21,258	802	22,084	835	28,344	1,070	17,715	594	16,534	485
8		0.016	20,995	792	18,896	713	17,846	673	25,195	950	15,746	528	14,697	431	
10		0.011	18,371	693	16,534	624	15,615	590	22,045	832	13,778	463	12,859	377	
0.1	12	0.01	16,330	548	14,697	493	13,880	408	19,596	657	12,247	359	11,431	288	
	16	0.006	16,330	480	14,697	431	13,880	378	19,596	575	12,247	308	11,431	239	
	20	0.004	12,247	359	11,022	323	10,410	284	14,697	431	9,185	231	8,573	180	
0.1	2	0.065	32,101	1,412	28,868	1,270	27,265	1,091	38,408	1,689	24,057	866	22,453	718	
	3	0.05	30,618	1,316	27,556	1,185	26,025	1,015	36,716	1,579	22,964	780	21,433	643	

[Note] Please refer to P620

Recommended Cutting Data (High Precision)

SPM200-RN2/SHM200-RN2

2 Flute, Corner Radius

Micro Diameter Endmills for Deep Machining

» Continuation

Workpiece Material				P						N		H				
				Carbon Steel, Alloy Steel (180~250HB)		Alloy Steel, Tool Steel (25~35HRC)		PH,Ferrite, Martensite Steel (35~45HRC)		Copper, Copper Alloys		Hardened Steel (45~55HRC)		Hardened Steel (55~65HRC)		
Ratio to standard depth of cut(ap)				1.00		0.90		0.80		1.20		0.65		0.60		
Mill Dia. (mm)	r (mm)	Under Neck Length (mm)	ap	n r/min	Vf mm/min	n r/min	Vf mm/min	n r/min	Vf mm/min	n r/min	Vf mm/min	n r/min	Vf mm/min	n r/min	Vf mm/min	
1	0.1	4	0.038	29,160	1,223	26,244	1,101	24,786	935	34,992	1,467	21,870	734	20,412	599	
		5	0.03	25,981	1,039	23,384	935	22,084	835	31,242	1,249	19,486	654	18,187	535	
		6	0.024	23,620	891	21,258	802	20,076	758	28,344	1,070	17,715	594	16,534	485	
		8	0.024	20,995	792	18,896	713	17,846	673	25,195	950	15,746	528	14,697	431	
		10	0.015	18,371	693	16,534	624	15,615	590	22,045	832	13,778	463	12,859	377	
		12	0.015	16,330	548	14,697	493	13,880	408	19,596	657	12,247	359	11,431	288	
		16	0.009	16,330	480	14,697	431	13,880	378	19,596	575	12,247	308	11,431	239	
		20	0.006	12,247	359	11,022	323	10,410	284	14,697	431	9,185	231	8,573	180	
	0.2	2	0.11	32,101	1,412	28,868	1,270	27,265	1,091	38,408	1,689	24,057	866	22,453	718	
		3	0.09	30,618	1,316	27,556	1,185	26,025	1,015	36,716	1,579	22,964	780	21,433	643	
		4	0.07	29,160	1,223	26,244	1,101	24,786	935	34,992	1,467	21,870	734	20,412	599	
		5	0.05	25,981	1,039	23,384	935	22,084	835	31,242	1,249	19,486	654	18,187	535	
		6	0.04	23,620	891	21,258	802	20,076	758	28,344	1,070	17,715	594	16,534	485	
		8	0.04	20,995	792	18,896	713	17,846	673	25,195	950	15,746	528	14,697	431	
		10	0.025	18,371	693	16,534	624	15,615	590	22,045	832	13,778	463	12,859	377	
		12	0.025	16,330	548	14,697	493	13,880	408	19,596	657	12,247	359	11,431	288	
	0.3	16	0.015	16,330	480	14,697	431	13,880	378	19,596	575	12,247	308	11,431	239	
		20	0.01	12,247	359	11,022	323	10,410	284	14,697	431	9,185	231	8,573	180	
		2	0.11	32,101	1,412	28,868	1,270	27,265	1,091	38,408	1,689	24,057	866	22,453	718	
		3	0.09	30,618	1,316	27,556	1,185	26,025	1,015	36,716	1,579	22,964	780	21,433	643	
		4	0.07	29,160	1,223	26,244	1,101	24,786	935	34,992	1,467	21,870	734	20,412	599	
		5	0.05	25,981	1,039	23,384	935	22,084	835	31,242	1,249	19,486	654	18,187	535	
		6	0.04	23,620	891	21,258	802	20,076	758	28,344	1,070	17,715	594	16,534	485	
		8	0.04	20,995	792	18,896	713	17,846	673	25,195	950	15,746	528	14,697	431	
	1.25	0.1	10	0.015	18,371	693	16,534	624	15,615	590	22,045	832	13,778	463	12,859	377
			15	0.01	16,330	480	14,697	493	13,880	408	19,596	575	12,247	308	11,431	239
			20	0.006	12,247	359	11,022	323	10,410	284	14,697	431	9,185	231	8,573	180

【Note】 Please refer to P620

Recommended Cutting Data (High Precision)

SPM200-RN2/SHM200-RN2

2 Flute, Corner Radius

» Continuation

Micro Diameter Endmills for Deep Machining

Workpiece Material				P						N		H			
				Carbon Steel, Alloy Steel (180~250HB)		Alloy Steel, Tool Steel (25~35HRC)		PH,Ferrite, Martensite Steel (35~45HRC)		Copper, Copper Alloys		Hardened Steel (45~55HRC)		Hardened Steel (55~65HRC)	
Ratio to standard depth of cut(ap)				1.00		0.90		0.80		1.20		0.65		0.60	
Mill Dia. (mm)	r (mm)	Under Neck Length (mm)	ap	n r/min	Vf mm/min	n r/min	Vf mm/min	n r/min	Vf mm/min	n r/min	Vf mm/min	n r/min	Vf mm/min	n r/min	Vf mm/min
1.25	0.2	5	0.05	25,981	1,039	23,384	935	22,084	835	31,242	1,249	19,486	654	18,187	535
		10	0.025	18,371	693	16,534	624	15,615	590	22,045	832	13,778	463	12,859	377
		15	0.016	16,330	480	14,697	493	13,880	408	19,596	575	12,247	308	11,431	239
		20	0.01	12,247	359	11,022	323	10,410	284	14,697	431	9,185	231	8,573	180
	0.3	5	0.05	25,981	1,039	23,384	935	22,084	835	31,242	1,249	19,486	654	18,187	535
		10	0.025	18,371	693	16,534	624	15,615	590	22,045	832	13,778	463	12,859	377
		15	0.016	16,330	480	14,697	493	13,880	408	19,596	575	12,247	308	11,431	239
		20	0.01	12,247	359	11,022	323	10,410	284	14,697	431	9,185	231	8,573	180
1.5	0.1	4	0.042	22,437	1,017	20,208	915	18,860	852	26,944	1,220	16,840	677	15,628	550
		6	0.04	21,401	967	19,299	872	18,344	829	25,605	1,157	16,051	644	14,904	524
		8	0.036	20,412	924	18,371	832	17,350	786	24,494	1,110	15,309	617	14,288	503
		12	0.036	16,330	740	14,697	666	13,880	628	19,596	887	12,247	493	11,431	402
		15	0.023	12,701	511	11,431	460	10,796	381	15,241	614	9,526	336	8,890	268
	0.2	4	0.07	22,437	1,017	20,208	915	18,860	781	26,944	1,220	16,840	610	15,628	500
		6	0.065	21,401	967	19,299	872	18,344	829	25,605	1,157	16,051	644	14,904	524
		8	0.06	20,412	924	18,371	832	17,350	786	24,494	1,110	15,309	617	14,288	503
		12	0.06	16,330	740	14,697	666	13,880	628	19,596	887	12,247	493	11,431	402
		15	0.038	12,701	511	11,431	460	10,796	381	15,241	614	9,526	336	8,890	268
	0.3	4	0.07	22,437	1,017	20,208	915	18,860	781	26,944	1,220	16,840	610	15,628	500
		6	0.065	21,401	967	19,299	872	18,344	829	25,605	1,157	16,051	644	14,904	524
		8	0.06	20,412	924	18,371	832	17,350	786	24,494	1,110	15,309	617	14,288	503
		12	0.06	16,330	740	14,697	666	13,880	628	19,596	887	12,247	493	11,431	402
		15	0.038	12,701	511	11,431	460	10,796	381	15,241	614	9,526	336	8,890	268
	0.5	4	0.085	22,437	1,017	20,208	915	18,860	781	26,944	1,220	16,840	610	15,628	500
		6	0.08	21,401	967	19,299	872	18,344	829	25,605	1,157	16,051	644	14,904	524
		8	0.07	20,412	924	18,371	832	17,350	786	24,494	1,110	15,309	617	14,288	503
		12	0.065	16,330	740	14,697	666	13,880	628	19,596	887	12,247	493	11,431	402
		15	0.045	12,701	511	11,431	460	10,796	381	15,241	614	9,526	336	8,890	268
20	0.035	12,701	511	11,431	460	10,796	381	15,241	614	9,526	336	8,890	268		

【Note】 Please refer to P620

Recommended Cutting Data (High Precision)

SPM200-RN2/SHM200-RN2

2 Flute, Corner Radius

Micro Diameter Endmills for Deep Machining

» Continuation

Workpiece Material				P						N		H			
				Carbon Steel, Alloy Steel (180~250HB)		Alloy Steel, Tool Steel (25~35HRC)		PH,Ferrite, Martensite Steel (35~45HRC)		Copper, Copper Alloys		Hardened Steel (45~55HRC)		Hardened Steel (55~65HRC)	
Ratio to standard depth of cut(ap)				1.00		0.90		0.80		1.20		0.65		0.60	
Mill Dia. (mm)	r (mm)	Under Neck Length (mm)	ap	n r/min	Vf mm/min	n r/min	Vf mm/min	n r/min	Vf mm/min	n r/min	Vf mm/min	n r/min	Vf mm/min	n r/min	Vf mm/min
1.75	0.1	5	0.04	22,437	1,017	20,208	915	18,860	781	26,944	1,220	16,840	610	15,628	500
		10	0.036	20,412	924	18,371	832	17,350	786	24,494	1,110	15,309	617	14,288	503
		15	0.023	12,701	511	11,431	460	10,796	381	15,241	614	9,526	336	8,890	268
		20	0.018	12,701	511	11,431	460	10,796	381	15,241	614	9,526	336	8,890	268
	0.2	5	0.065	22,437	1,017	20,208	915	18,860	781	26,944	1,220	16,840	610	15,628	500
		10	0.06	20,412	924	18,371	832	17,350	786	24,494	1,110	15,309	617	14,288	503
		15	0.038	12,701	511	11,431	460	10,796	381	15,241	614	9,526	336	8,890	268
		20	0.03	12,701	511	11,431	460	10,796	381	15,241	614	9,526	336	8,890	268
	0.3	5	0.065	22,437	1,017	20,208	915	18,860	781	26,944	1,220	16,840	610	15,628	500
		10	0.06	20,412	924	18,371	832	17,350	786	24,494	1,110	15,309	617	14,288	503
		15	0.038	12,701	511	11,431	460	10,796	381	15,241	614	9,526	336	8,890	268
		20	0.03	12,701	511	11,431	460	10,796	381	15,241	614	9,526	336	8,890	268
2	0.1	4	0.08	19,777	1,554	17,771	1,396	16,624	1,306	23,503	1,847	14,761	930	13,757	756
		6	0.07	18,711	1,472	16,840	1,324	15,905	1,250	22,453	1,766	14,034	883	13,098	721
		8	0.055	17,010	1,337	15,309	1,203	14,459	1,137	20,412	1,605	12,758	803	11,907	655
		12	0.03	13,778	975	12,400	878	11,712	829	16,534	1,170	10,334	650	9,644	531
		16	0.03	12,247	867	11,022	780	10,410	736	14,697	1,040	9,185	578	8,573	472
		20	0.025	10,716	759	9,644	682	9,109	644	12,859	910	8,037	506	7,502	413
		25	0.015	10,716	681	9,644	613	9,109	579	12,859	817	8,037	455	7,502	370
		30	0.01	10,181	647	9,162	582	8,654	550	12,217	777	7,636	432	7,126	352
	0.2	4	0.1	19,777	1,554	17,771	1,396	16,624	1,306	23,503	1,847	14,761	930	13,757	756
		6	0.08	18,711	1,472	16,840	1,324	15,905	1,250	22,453	1,766	14,034	883	13,098	721
		8	0.07	17,010	1,337	15,309	1,203	14,459	1,137	20,412	1,605	12,758	803	11,907	655
		12	0.04	13,778	975	12,400	878	11,712	829	16,534	1,170	10,334	650	9,644	531
0.3	16	0.04	12,247	867	11,022	780	10,410	736	14,697	1,040	9,185	578	8,573	472	
	20	0.035	10,716	759	9,644	682	9,109	644	12,859	910	8,037	506	7,502	413	
	25	0.025	10,716	681	9,644	613	9,109	579	12,859	817	8,037	455	7,502	370	
	30	0.017	10,181	647	9,162	582	8,654	550	12,217	777	7,636	432	7,126	352	
0.3	4	0.13	19,777	1,554	17,771	1,396	16,624	1,306	23,503	1,847	14,761	930	13,757	756	
	6	0.11	18,711	1,472	16,840	1,324	15,905	1,250	22,453	1,766	14,034	883	13,098	721	
	8	0.09	17,010	1,337	15,309	1,203	14,459	1,137	20,412	1,605	12,758	803	11,907	655	
	12	0.06	13,778	975	12,400	878	11,712	829	16,534	1,300	10,334	650	9,644	531	

【Note】 Please refer to P620

Recommended Cutting Data (High Precision)

SPM200-RN2/SHM200-RN2

2 Flute, Corner Radius

» Continuation

Micro Diameter Endmills for Deep Machining

Workpiece Material				P						N		H				
				Carbon Steel, Alloy Steel (180~250HB)		Alloy Steel, Tool Steel (25~35HRC)		PH,Ferrite, Martensite Steel (35~45HRC)		Copper, Copper Alloys		Hardened Steel (45~55HRC)		Hardened Steel (55~65HRC)		
Ratio to standard depth of cut(ap)				1.00		0.90		0.80		1.20		0.65		0.60		
Mill Dia. (mm)	r (mm)	Under Neck Length (mm)	ap	n r/min	Vf mm/min	n r/min	Vf mm/min	n r/min	Vf mm/min	n r/min	Vf mm/min	n r/min	Vf mm/min	n r/min	Vf mm/min	
2	0.3	16	0.06	12,247	867	11,022	780	10,410	736	14,697	1,156	9,185	578	8,573	472	
		20	0.037	10,716	759	9,644	682	9,109	644	12,859	1,011	8,037	506	7,502	413	
		25	0.03	10,716	681	9,644	613	9,109	579	12,859	817	8,037	455	7,502	370	
		30	0.021	10,181	647	9,162	582	8,654	550	12,217	777	7,636	432	7,126	352	
	0.5	6	0.17	18,711	1,472	16,840	1,324	15,905	1,250	22,453	1,766	14,034	883	13,098	721	
		8	0.14	17,010	1,337	15,309	1,203	14,459	1,137	20,412	1,605	12,758	803	11,907	655	
		12	0.08	13,778	975	12,400	878	11,712	921	16,534	1,300	10,334	650	9,644	531	
		16	0.08	12,247	867	11,022	780	10,410	736	14,697	1,156	9,185	578	8,573	472	
		20	0.05	10,716	759	9,644	682	9,109	644	12,859	1,011	8,037	506	7,502	413	
		25	0.05	10,716	681	9,644	613	9,109	579	12,859	817	8,037	455	7,502	370	
	0.8	6	0.22	18,711	1,472	16,840	1,324	15,905	1,250	22,453	1,766	14,034	883	13,098	721	
		8	0.2	17,010	1,337	15,309	1,203	14,459	1,137	20,412	1,605	12,758	803	11,907	655	
		12	0.13	13,778	975	12,400	878	11,712	829	16,534	1,300	10,334	650	9,644	531	
		16	0.1	12,247	867	11,022	780	10,410	736	14,697	1,156	9,185	578	8,573	472	
		20	0.06	10,716	759	9,644	682	9,109	644	12,859	1,011	8,037	506	7,502	413	
		25	0.057	10,716	681	9,644	613	9,109	579	12,859	817	8,037	455	7,502	370	
	2.5	0.1	10	0.055	17,010	1,337	15,309	1,203	14,459	1,137	20,412	1,605	12,758	803	11,907	655
			20	0.03	12,247	867	11,022	780	10,410	736	14,697	1,156	9,185	578	8,573	472
			30	0.015	10,716	681	9,644	613	9,109	579	12,859	907	8,037	455	7,502	370
		0.2	10	0.07	17,010	1,337	15,309	1,203	14,459	1,137	20,412	1,605	12,758	803	11,907	655
			20	0.04	12,247	867	11,022	780	10,410	736	14,697	1,156	9,185	578	8,573	472
			30	0.025	10,716	681	9,644	613	9,109	579	12,859	907	8,037	455	7,502	370
		0.3	10	0.09	17,010	1,337	15,309	1,203	14,459	1,137	20,412	1,605	12,758	803	11,907	655
			20	0.06	12,247	867	11,022	780	10,410	736	14,697	1,156	9,185	578	8,573	472
30			0.03	10,716	681	9,644	613	9,109	579	12,859	907	8,037	455	7,502	370	
0.5		10	0.14	17,010	1,337	15,309	1,203	14,459	1,137	20,412	1,605	12,758	803	11,907	655	
		20	0.08	12,247	867	11,022	780	10,410	736	14,697	1,156	9,185	578	8,573	472	
		30	0.05	10,716	681	9,644	613	9,109	579	12,859	907	8,037	455	7,502	370	
3	0.1	6	0.08	12,960	1,274	11,664	1,147	11,016	1,083	15,552	1,528	9,720	764	9,072	624	
		8	0.07	12,960	1,274	11,664	1,147	11,016	1,083	15,552	1,528	9,720	764	9,072	624	

【Note】 Please refer to P620

Recommended Cutting Data (High Precision)

SPM200-RN2/SHM200-RN2

2 Flute, Corner Radius

Micro Diameter Endmills for Deep Machining

» Continuation

Workpiece Material				P						N		H			
				Carbon Steel, Alloy Steel (180~250HB)		Alloy Steel, Tool Steel (25~35HRC)		PH,Ferrite, Martensite Steel (35~45HRC)		Copper, Copper Alloys		Hardened Steel (45~55HRC)		Hardened Steel (55~65HRC)	
Ratio to standard depth of cut(ap)				1.00		0.90		0.80		1.20		0.65		0.60	
Mill Dia. (mm)	r (mm)	Under Neck Length (mm)	ap	n r/min	Vf mm/min	n r/min	Vf mm/min	n r/min	Vf mm/min	n r/min	Vf mm/min	n r/min	Vf mm/min	n r/min	Vf mm/min
3	0.1	12	0.05	12,960	1,274	11,664	1,147	11,016	1,083	15,552	1,528	9,720	764	9,072	624
		16	0.035	12,960	1,274	11,664	1,147	11,016	1,083	15,552	1,528	9,720	764	9,072	624
		18	0.035	11,656	1,144	10,509	1,034	9,841	966	13,948	1,369	8,789	690	8,121	558
		20	0.035	10,498	1,031	9,448	929	8,923	877	12,597	1,238	7,873	618	7,349	505
		30	0.027	8,165	721	7,349	649	6,940	613	9,797	866	6,124	432	5,715	354
		35	0.02	8,165	721	7,349	649	6,940	613	9,797	866	6,124	432	5,715	354
	0.2	6	0.1	12,960	1,274	11,664	1,147	11,016	1,083	15,552	1,528	9,720	764	9,072	624
		8	0.09	12,960	1,274	11,664	1,147	11,016	1,083	15,552	1,528	9,720	764	9,072	624
		12	0.07	12,960	1,274	11,664	1,147	11,016	1,083	15,552	1,528	9,720	764	9,072	624
		16	0.05	12,960	1,274	11,664	1,147	11,016	1,083	15,552	1,528	9,720	764	9,072	624
		18	0.05	11,656	1,144	10,509	1,034	9,841	966	13,948	1,369	8,789	690	8,121	558
		20	0.05	10,498	1,031	9,448	929	8,923	877	12,597	1,238	7,873	618	7,349	505
		30	0.04	8,165	721	7,349	649	6,940	613	9,797	866	6,124	432	5,715	354
	0.3	35	0.035	8,165	721	7,349	649	6,940	613	9,797	866	6,124	432	5,715	354
		6	0.145	12,960	1,274	11,664	1,147	11,016	1,083	15,552	1,528	9,720	764	9,072	624
		8	0.13	12,960	1,274	11,664	1,147	11,016	1,083	15,552	1,528	9,720	764	9,072	624
		12	0.1	12,960	1,274	11,664	1,147	11,016	1,083	15,552	1,528	9,720	764	9,072	624
		16	0.075	12,960	1,274	11,664	1,147	11,016	1,083	15,552	1,528	9,720	764	9,072	624
		18	0.075	11,656	1,144	10,509	1,034	9,841	966	13,948	1,369	8,789	690	8,121	558
		20	0.075	10,498	1,031	9,448	929	8,923	877	12,597	1,238	7,873	618	7,349	505
	0.5	30	0.06	8,165	721	7,349	649	6,940	613	9,797	866	6,124	432	5,715	354
		35	0.05	8,165	721	7,349	649	6,940	613	9,797	866	6,124	432	5,715	354
		8	0.18	12,960	1,274	11,664	1,147	11,016	1,083	15,552	1,528	9,720	764	9,072	624
		12	0.13	12,960	1,274	11,664	1,147	11,016	1,083	15,552	1,528	9,720	764	9,072	624
		16	0.1	12,960	1,274	11,664	1,147	11,016	1,083	15,552	1,528	9,720	764	9,072	624
		18	0.1	11,656	1,144	10,509	1,034	9,841	966	13,948	1,369	8,789	690	8,121	558
		20	0.1	10,498	1,031	9,448	929	8,923	877	12,597	1,238	7,873	618	7,349	505
	1	30	0.08	8,165	721	7,349	649	6,940	613	9,797	866	6,124	432	5,715	354
35		0.065	8,165	721	7,349	649	6,940	613	9,797	866	6,124	432	5,715	354	
8		0.2	12,960	1,274	11,664	1,147	11,016	1,083	15,552	1,528	9,720	764	9,072	624	
12		0.15	12,960	1,274	11,664	1,147	11,016	1,083	15,552	1,528	9,720	764	9,072	624	
		16	0.12	12,960	1,274	11,664	1,147	11,016	1,083	15,552	1,528	9,720	764	9,072	624

【Note】 Please refer to P620

Recommended Cutting Data (High Precision)

SPM200-RN2/SHM200-RN2

2 Flute, Corner Radius

» Continuation

Micro Diameter Endmills for Deep Machining

Workpiece Material				P						N		H			
				Carbon Steel, Alloy Steel (180~250HB)		Alloy Steel, Tool Steel (25~35HRC)		PH,Ferrite, Martensite Steel (35~45HRC)		Copper, Copper Alloys		Hardened Steel (45~55HRC)		Hardened Steel (55~65HRC)	
Ratio to standard depth of cut(ap)				1.00		0.90		0.80		1.20		0.65		0.60	
Mill Dia. (mm)	r (mm)	Under Neck Length (mm)	ap	n r/min	Vf mm/min	n r/min	Vf mm/min	n r/min	Vf mm/min	n r/min	Vf mm/min	n r/min	Vf mm/min	n r/min	Vf mm/min
3	1	18	0.11	11,656	1,144	10,509	1,034	9,841	966	13,948	1,369	8,789	690	8,121	558
		20	0.11	10,498	1,031	9,448	929	8,923	877	12,597	1,238	7,873	618	7,349	505
		30	0.09	8,165	721	7,349	649	6,940	613	9,797	866	6,124	432	5,715	354
		35	0.075	8,165	721	7,349	649	6,940	613	9,797	866	6,124	432	5,715	354
4	0.1	8	0.08	10,092	1,755	9,082	1,580	8,578	1,492	12,110	2,106	7,569	1,053	7,064	860
		12	0.065	10,092	1,755	9,082	1,580	8,578	1,492	12,110	2,106	7,569	1,053	7,064	860
		16	0.06	9,230	1,605	8,240	1,433	7,827	1,361	11,124	1,934	6,839	951	6,016	733
		20	0.055	9,230	1,605	8,240	1,433	7,827	1,361	11,124	1,934	6,839	951	6,016	733
		30	0.045	9,230	1,605	8,240	1,433	6,180	968	11,124	1,934	4,942	619	4,612	505
		35	0.04	9,230	1,605	8,240	1,433	6,180	968	11,124	1,934	4,942	619	4,612	505
		45	0.03	7,416	968	6,592	860	5,026	655	8,899	1,160	4,450	464	3,707	322
	0.2	8	0.16	10,092	1,755	9,082	1,580	8,578	1,492	12,110	2,106	7,569	1,053	7,064	860
		12	0.14	10,092	1,755	9,082	1,580	8,578	1,492	12,110	2,106	7,569	1,053	7,064	860
		16	0.13	9,230	1,605	8,240	1,433	7,827	1,361	11,124	1,934	6,839	951	6,016	733
		20	0.11	9,230	1,605	8,240	1,433	7,827	1,361	11,124	1,934	6,839	951	6,016	733
		30	0.1	9,230	1,605	8,240	1,433	6,180	968	11,124	1,934	4,942	619	4,612	505
		35	0.08	9,230	1,605	8,240	1,433	6,180	968	11,124	1,934	4,942	619	4,612	505
		45	0.06	7,416	968	6,592	860	5,026	655	8,899	1,160	4,450	464	3,707	322
	0.3	8	0.24	10,092	1,755	9,082	1,580	8,578	1,492	12,110	2,106	7,569	1,053	7,064	860
		12	0.22	10,092	1,755	9,082	1,580	8,578	1,492	12,110	2,106	7,569	1,053	7,064	860
		16	0.2	9,230	1,605	8,240	1,433	7,827	1,361	11,124	1,934	6,839	951	6,016	733
		20	0.18	9,230	1,605	8,240	1,433	7,827	1,361	11,124	1,934	6,839	951	6,016	733
		30	0.16	9,230	1,605	8,240	1,433	6,180	968	11,124	1,934	4,942	619	4,612	505
		35	0.14	9,230	1,605	8,240	1,433	6,180	968	11,124	1,934	4,942	619	4,612	505
		45	0.12	7,416	968	6,592	860	5,026	655	8,899	1,160	4,450	464	3,707	322
	0.5	12	0.35	10,092	1,755	9,082	1,580	8,578	1,492	12,110	2,106	7,569	1,053	7,064	860
		16	0.25	9,230	1,605	8,240	1,433	7,827	1,361	11,124	1,934	6,839	951	6,016	733
		20	0.2	9,230	1,605	8,240	1,433	7,827	1,361	11,124	1,934	6,839	951	6,016	733
30		0.15	9,230	1,605	8,240	1,433	6,180	968	11,124	1,934	4,942	619	4,612	505	
35		0.1	9,230	1,605	8,240	1,433	6,180	968	11,124	1,934	4,942	619	4,612	505	
1	12	0.4	10,092	1,755	9,082	1,580	8,578	1,492	12,110	2,106	7,569	1,053	7,064	860	

[Note] Please refer to P620

Recommended Cutting Data (High Precision)

SPM200-RN2/SHM200-RN2

2 Flute, Corner Radius

» Continuation

Micro Diameter Endmills for Deep Machining

Workpiece Material				P						N		H			
				Carbon Steel, Alloy Steel (180~250HB)		Alloy Steel, Tool Steel (25~35HRC)		PH,Ferrite, Martensite Steel (35~45HRC)		Copper, Copper Alloys		Hardened Steel (45~55HRC)		Hardened Steel (55~65HRC)	
Ratio to standard depth of cut(ap)				1.00		0.90		0.80		1.20		0.65		0.60	
Mill Dia. (mm)	r (mm)	Under Neck Length (mm)	ap	n r/min	Vf mm/min	n r/min	Vf mm/min	n r/min	Vf mm/min	n r/min	Vf mm/min	n r/min	Vf mm/min	n r/min	Vf mm/min
4	1	16	0.29	9,230	1,605	8,240	1,433	7,827	1,361	11,124	1,934	6,839	951	6,016	733
		20	0.23	9,230	1,605	8,240	1,433	7,827	1,361	11,124	1,934	6,839	951	6,016	733
		30	0.17	9,230	1,605	8,240	1,433	6,180	968	11,124	1,934	4,942	619	4,612	505
		35	0.12	9,230	1,605	8,240	1,433	6,180	968	11,124	1,934	4,942	619	4,612	505
		45	0.06	7,416	968	6,592	860	5,026	655	8,899	1,160	4,450	464	3,707	322
5	0.1	20	0.08	8,239	1,791	7,415	1,612	7,003	1,523	9,887	2,149	6,179	1,075	5,767	878
		40	0.06	5,931	1,156	5,338	1,040	5,042	982	7,116	1,386	4,449	693	4,152	566
	0.2	20	0.16	8,239	1,791	7,415	1,612	7,003	1,523	9,887	2,149	6,179	1,075	5,767	878
		40	0.13	5,931	1,156	5,338	1,040	5,042	982	7,116	1,386	4,449	693	4,152	566
	0.3	20	0.24	8,239	1,791	7,415	1,612	7,003	1,523	9,887	2,149	6,179	1,075	5,767	878
		40	0.2	5,931	1,156	5,338	1,040	5,042	982	7,116	1,386	4,449	693	4,152	566
	0.5	20	0.35	8,239	1,791	7,415	1,612	7,003	1,523	9,887	2,149	6,179	1,075	5,767	878
		40	0.135	5,931	1,156	5,338	1,040	5,042	982	7,116	1,386	4,449	693	4,152	566
	1	20	0.4	8,239	1,791	7,415	1,612	7,003	1,523	9,887	2,149	6,179	1,075	5,767	878
		40	0.15	5,931	1,156	5,338	1,040	5,042	982	7,116	1,386	4,449	693	4,152	566
6	0.1	12	0.08	6,867	1,792	6,181	1,612	5,837	1,523	8,240	2,150	5,150	1,075	4,808	878
		18	0.065	6,867	1,792	6,181	1,612	5,837	1,523	8,240	2,150	5,150	1,075	4,808	878
		24	0.06	6,867	1,792	6,181	1,612	5,837	1,523	8,240	2,150	5,150	1,075	4,808	878
		35	0.05	5,837	1,371	5,253	1,234	4,962	1,165	7,005	1,644	4,379	823	4,086	671
		55	0.04	4,942	945	4,449	851	4,201	803	5,931	1,134	3,706	561	3,460	457
	0.2	12	0.16	6,867	1,792	6,181	1,612	5,837	1,523	8,240	2,150	5,150	1,075	4,808	878
		18	0.14	6,867	1,792	6,181	1,612	5,837	1,523	8,240	2,150	5,150	1,075	4,808	878
		24	0.13	6,867	1,792	6,181	1,612	5,837	1,523	8,240	2,150	5,150	1,075	4,808	878
		35	0.11	5,837	1,371	5,253	1,234	4,962	1,165	7,005	1,644	4,379	823	4,086	671
		55	0.08	4,942	945	4,449	851	4,201	803	5,931	1,134	3,706	561	3,460	457
	0.3	12	0.24	6,867	1,792	6,181	1,612	5,837	1,523	8,240	2,150	5,150	1,075	4,808	878
		18	0.22	6,867	1,792	6,181	1,612	5,837	1,523	8,240	2,150	5,150	1,075	4,808	878
		24	0.2	6,867	1,792	6,181	1,612	5,837	1,523	8,240	2,150	5,150	1,075	4,808	878
		35	0.18	5,837	1,371	5,253	1,234	4,962	1,165	7,005	1,644	4,379	823	4,086	671
		55	0.14	4,942	945	4,449	851	4,201	803	5,931	1,134	3,706	561	3,460	457
	0.5	18	0.35	6,867	1,792	6,181	1,612	5,837	1,523	8,240	2,150	5,150	1,075	4,808	878
		24	0.29	6,867	1,792	6,181	1,612	5,837	1,523	8,240	2,150	5,150	1,075	4,808	878

【Note】 Please refer to P620

Recommended Cutting Data (High Precision)

SPM200-RN2/SHM200-RN2

2 Flute, Corner Radius

» Continuation

Micro Diameter Endmills for Deep Machining

Workpiece Material				P						N		H			
				Carbon Steel, Alloy Steel (180~250HB)		Alloy Steel, Tool Steel (25~35HRC)		PH,Ferrite, Martensite Steel (35~45HRC)		Copper, Copper Alloys		Hardened Steel (45~55HRC)		Hardened Steel (55~65HRC)	
Ratio to standard depth of cut(ap)				1.00		0.90		0.80		1.20		0.65		0.60	
Mill Dia. (mm)	r (mm)	Under Neck Length (mm)	ap	n r/min	Vf mm/min	n r/min	Vf mm/min	n r/min	Vf mm/min	n r/min	Vf mm/min	n r/min	Vf mm/min	n r/min	Vf mm/min
6	0.5	35	0.24	5,837	1,371	5,253	1,234	4,962	1,165	7,005	1,644	4,379	823	4,086	671
		55	0.165	4,942	945	4,449	851	4,201	803	5,931	1,134	3,706	561	3,460	457
	1	18	0.4	6,867	1,792	6,181	1,612	5,837	1,523	8,240	2,150	5,150	1,075	4,808	878
		24	0.35	6,867	1,792	6,181	1,612	5,837	1,523	8,240	2,150	5,150	1,075	4,808	878
		35	0.28	5,837	1,371	5,253	1,234	4,962	1,165	7,005	1,644	4,379	823	4,086	671
		55	0.2	4,942	945	4,449	851	4,201	803	5,931	1,134	3,706	561	3,460	457

【Note】

1. For different materials, adjust the cutting depth (ap) according to the cutting depth factors in the above table. E.g. for hardened Steel (45~55HRC), $ap \times 0.5$.
2. Use the appropriate coolant such as air cooling or emulsion for the work material and machining shape.
3. In actual machining, the condition should be adjusted according to the machining shape, purpose and the machine type.
4. If the rpm of the machine is lower than the data in the above table, the feed rate should also be lowered in the same ratio.

Recommended Cutting Data (High Precision)

SPM200-RN4/SHM200-RN4

4 Flute, Corner Radius

Micro Diameter Endmills for Deep Machining

Workpiece Material				P						N		H			
				Carbon Steel, Alloy Steel (180~250HB)		Alloy Steel, Tool Steel (25~35HRC)		PH,Ferrite, Martensite Steel (35~45HRC)		Copper, Copper Alloys		Hardened Steel (45~55HRC)		Hardened Steel (55~65HRC)	
Ratio to standard depth of cut(ap)				1.00		0.90		0.80		1.20		0.65		0.60	
Mill Dia. (mm)	r (mm)	Under Neck Length (mm)	ap	n r/min	Vf mm/min	n r/min	Vf mm/min	n r/min	Vf mm/min	n r/min	Vf mm/min	n r/min	Vf mm/min	n r/min	Vf mm/min
1	0.05	4	0.012	31,120	1,952	28,008	1,757	26,608	1,669	38,900	2,440	23,947	1,230	22,749	1,000
		6	0.01	25,200	1,424	22,680	1,282	21,546	1,218	31,500	1,780	19,391	990	18,422	810
		8	0.008	22,400	1,264	20,160	1,138	19,152	1,081	28,000	1,580	17,237	880	16,375	720
		10	0.005	19,600	1,112	17,640	1,001	16,758	951	24,500	1,390	15,082	770	14,328	630
		12	0.004	17,440	880	15,696	792	14,911	752	21,800	1,100	13,420	600	12,749	480
		16	0.003	17,440	768	15,696	691	14,911	657	21,800	960	13,420	510	12,749	400
		20	0.002	13,040	576	11,736	518	11,149	492	16,300	720	10,034	385	9,533	300
	0.1	4	0.02	31,120	1,952	28,008	1,757	26,608	1,669	38,900	2,440	23,947	1,230	22,749	1,000
		6	0.018	25,200	1,424	22,680	1,282	21,546	1,218	31,500	1,780	19,391	990	18,422	810
		8	0.014	22,400	1,264	20,160	1,138	19,152	1,081	28,000	1,580	17,237	880	16,375	720
		10	0.01	19,600	1,112	17,640	1,001	16,758	951	24,500	1,390	15,082	770	14,328	630
		12	0.008	17,440	880	15,696	792	14,911	752	21,800	1,100	13,420	600	12,749	480
		16	0.006	17,440	768	15,696	691	14,911	657	21,800	960	13,420	510	12,749	400
		20	0.004	13,040	576	11,736	518	11,149	492	16,300	720	10,034	385	9,533	300
1.5	0.05	4	0.02	23,920	1,624	21,528	1,462	20,452	1,389	29,900	2,030	18,406	1,020	17,486	830
		8	0.014	21,760	1,480	19,584	1,332	18,605	1,265	27,200	1,850	16,744	1,030	15,907	840
		12	0.007	17,440	1,184	15,696	1,066	14,911	1,012	21,800	1,480	13,420	820	12,749	670
		15	0.006	13,520	816	12,168	734	11,560	698	16,900	1,020	10,404	560	9,883	450
	0.1	4	0.027	23,920	1,624	21,528	1,462	20,452	1,389	29,900	2,030	18,406	1,020	17,486	830
		8	0.02	21,760	1,480	19,584	1,332	18,605	1,265	27,200	1,850	16,744	1,030	15,907	840
		12	0.017	17,440	1,184	15,696	1,066	14,911	1,012	21,800	1,480	13,420	820	12,749	670
		15	0.014	13,520	816	12,168	734	11,560	698	16,900	1,020	10,404	560	9,883	450
		20	0.01	13,520	816	12,168	734	11,560	698	16,900	1,020	10,404	560	9,883	450
		20	0.01	13,520	816	12,168	734	11,560	698	16,900	1,020	10,404	560	9,883	450
2	0.05	4	0.035	20,800	2,450	18,700	2,210	17,700	2,080	24,900	2,940	15,600	1,470	14,600	1,200
		6	0.03	20,800	2,450	18,700	2,210	17,700	2,080	24,900	2,940	15,600	1,470	14,600	1,200
		8	0.025	18,900	2,230	17,000	2,010	16,100	1,890	22,700	2,670	14,200	1,340	13,200	1,090
		12	0.02	15,300	1,620	13,800	1,460	13,000	1,380	18,400	1,950	11,500	1,080	10,700	890
		16	0.015	13,600	1,440	12,200	1,300	11,600	1,230	16,300	1,730	10,200	960	9,500	790
		20	0.01	11,900	1,260	10,700	1,140	10,100	1,070	14,300	1,520	8,900	840	8,300	690

【Note】 Please refer to P625

Recommended Cutting Data (High Precision)

SPM200-RN4/SHM200-RN4

4 Flute, Corner Radius

» Continuation

Micro Diameter Endmills for Deep Machining

Workpiece Material				P						N		H			
				Carbon Steel, Alloy Steel (180~250HB)		Alloy Steel, Tool Steel (25~35HRC)		PH,Ferrite, Martensite Steel (35~45HRC)		Copper, Copper Alloys		Hardened Steel (45~55HRC)		Hardened Steel (55~65HRC)	
Ratio to standard depth of cut(ap)				1.00		0.90		0.80		1.20		0.65		0.60	
Mill Dia. (mm)	r (mm)	Under Neck Length (mm)	ap	n r/min	Vf mm/min	n r/min	Vf mm/min	n r/min	Vf mm/min	n r/min	Vf mm/min	n r/min	Vf mm/min	n r/min	Vf mm/min
2	0.1	4	0.042	20,800	2,450	18,700	2,210	17,700	2,080	24,900	2,940	15,600	1,470	14,600	1,200
		6	0.042	20,800	2,450	18,700	2,210	17,700	2,080	24,900	2,940	15,600	1,470	14,600	1,200
		8	0.036	18,900	2,230	17,000	2,010	16,100	1,890	22,700	2,670	14,200	1,340	13,200	1,090
		12	0.036	15,300	1,620	13,800	1,460	13,000	1,380	18,400	1,950	11,500	1,080	10,700	890
		16	0.023	13,600	1,440	12,200	1,300	11,600	1,230	16,300	1,730	10,200	960	9,500	790
		20	0.018	11,900	1,260	10,700	1,140	10,100	1,070	14,300	1,520	8,900	840	8,300	690
	0.2	4	0.08	20,800	2,450	18,700	2,210	17,700	2,080	24,900	2,940	15,600	1,470	14,600	1,200
		6	0.08	20,800	2,450	18,700	2,210	17,700	2,080	24,900	2,940	15,600	1,470	14,600	1,200
		8	0.07	18,900	2,230	17,000	2,010	16,100	1,890	22,700	2,670	14,200	1,340	13,200	1,090
		12	0.04	15,300	1,620	13,800	1,460	13,000	1,380	18,400	1,950	11,500	1,080	10,700	890
		16	0.04	13,600	1,440	12,200	1,300	11,600	1,230	16,300	1,730	10,200	960	9,500	790
		20	0.035	11,900	1,260	10,700	1,140	10,100	1,070	14,300	1,520	8,900	840	8,300	690
	0.3	25	0.025	11,900	1,260	10,700	1,140	10,100	1,070	14,300	1,520	8,900	840	8,300	690
		30	0.017	11,300	1,200	10,200	1,080	9,600	1,020	13,600	1,440	8,500	800	7,900	650
	0.5	4	0.11	20,800	2,450	18,700	2,210	17,700	2,080	24,900	2,940	15,600	1,470	14,600	1,200
		8	0.09	18,900	2,350	17,000	2,100	16,100	1,950	22,700	2,850	14,200	1,490	13,200	1,210
		12	0.06	15,300	1,810	13,800	1,620	13,000	1,530	18,400	2,170	11,500	1,200	10,700	980
		16	0.06	13,600	1,610	12,200	1,440	11,600	1,360	16,300	1,930	10,200	1,070	9,500	870
		20	0.037	11,900	1,400	10,700	1,260	10,100	1,190	14,300	1,680	8,900	940	8,300	770
		4	0.17	20,800	2450	18,700	2210	17,700	2,080	24,900	2940	15,600	1,470	14,600	1,200
	0.1	6	0.17	20,800	2450	18,700	2210	17,700	2,080	24,900	2940	15,600	1,470	14,600	1,200
		8	0.14	18,900	2350	17,000	2100	16,100	1,950	22,700	2850	14,200	1,490	13,200	1,210
		12	0.08	15,300	1810	13,800	1620	13,000	1,530	18,400	2170	11,500	1,200	10,700	980
		16	0.08	13,600	1610	12,200	1440	11,600	1,360	16,300	1930	10,200	1,070	9,500	870
20		0.05	11,900	1400	10,700	1260	10,100	1,190	14,300	1680	8,900	940	8,300	770	
25		0.05	11,900	1400	10,700	1260	10,100	1,190	14,300	1680	8,900	940	8,300	770	
2.5	0.1	30	0.03	11,300	1330	10,200	1200	9,600	1,130	13,600	1600	8,500	850	7,900	730
		8	0.047	18,900	2480	17,000	2230	16,100	2,100	22,700	2970	14,200	1,490	13,200	1,210
		16	0.037	13,600	1610	12,200	1440	11,600	1,360	16,300	1930	10,200	1,070	9,500	870
		20	0.025	11,900	1400	10,700	1260	10,100	1,190	14,300	1680	8,900	940	8,300	770

【Note】 Please refer to P625

Recommended Cutting Data (High Precision)

SPM200-RN4/SHM200-RN4

4 Flute, Corner Radius

» Continuation

Micro Diameter Endmills for Deep Machining

Workpiece Material				P						N		H			
				Carbon Steel, Alloy Steel (180~250HB)		Alloy Steel, Tool Steel (25~35HRC)		PH,Ferrite, Martensite Steel (35~45HRC)		Copper, Copper Alloys		Hardened Steel (45~55HRC)		Hardened Steel (55~65HRC)	
Ratio to standard depth of cut(ap)				1.00		0.90		0.80		1.20		0.65		0.60	
Mill Dia. (mm)	r (mm)	Under Neck Length (mm)	ap	n r/min	Vf mm/min	n r/min	Vf mm/min	n r/min	Vf mm/min	n r/min	Vf mm/min	n r/min	Vf mm/min	n r/min	Vf mm/min
2.5	0.2	8	0.08	16,200	2140	14,600	1920	13,800	1,820	19,400	2570	12,200	1,280	11300	1,100
		16	0.045	14,100	1770	12,700	1600	12,000	1,510	16,900	2130	10,600	1,110	9,900	960
		20	0.042	11,800	1410	10,600	1270	10,000	1,200	14,100	1750	8,800	930	8,200	790
	0.3	12	0.09	14,800	1960	13,300	1760	12,500	1,660	17,700	2350	11,100	1,230	10,300	1,010
		20	0.052	11,800	1560	10600	1400	10,000	1330	14,100	1870	8,800	1,040	8,200	850
	0.5	12	0.1	14,800	1,960	13,300	1,760	12,500	1,660	17,700	2,350	11,100	1,230	10,300	1,010
20		0.07	11,800	1,560	10,600	1,400	10,000	1,330	14,100	1,870	8,800	1,040	8,200	850	
3	0.1	8	0.055	14,400	2,120	13,000	1,910	12,200	1,800	17,300	2,550	10,800	1,270	10,100	1,040
		16	0.035	14,400	2,120	13,000	1,910	12,200	1,800	17,300	2,550	10,800	1,270	10,100	1,040
		25	0.022	11,700	1,720	10,500	1,550	9,900	1,460	14,000	2,060	8,700	1,150	8,200	940
		30	0.014	9,100	1,720	8,200	1,550	7,700	1,460	10,900	2,060	6,800	1,150	6,400	940
	0.2	8	0.09	14,400	2,120	13,000	1,910	12,200	1,800	17,300	2,550	10,800	1,270	10,100	1,040
		12	0.07	14,400	2,120	13,000	1,910	12,200	1,800	17,300	2,550	10,800	1,270	10,100	1,040
		16	0.05	14,400	2,120	13,000	1,910	12,200	1,800	17,300	2,550	10,800	1,270	10,100	1,040
		20	0.05	11,700	1,720	10,500	1,550	9,900	1,460	14,000	2,060	8,700	1,150	8,200	940
		25	0.045	11,700	1,720	10,500	1,550	9,900	1,460	14,000	2,060	8,700	1,150	8,200	940
		30	0.04	9,100	1,720	8,200	1,550	7,700	1,460	10,900	2,060	6,800	1,150	6,400	940
	0.3	8	0.13	14,400	2,360	13,000	2,120	12,200	2,010	17,300	2,830	10,800	1,410	10,100	1,160
		16	0.075	14,400	2,360	13,000	2,120	12,200	2,010	17,300	2,830	10,800	1,410	10,100	1,160
		20	0.075	11,700	1,910	10,500	1,720	9,900	1,620	14,000	2,290	8,700	1,270	8,200	1,040
		25	0.067	11,700	1,910	10,500	1,720	9,900	1,620	14,000	2,290	8,700	1,270	8,200	1,040
		30	0.06	9,100	1,910	8,200	1,720	7,700	1,620	10,900	2,290	6,800	1,270	6,400	1,040
	0.5	8	0.18	14,400	2,360	13,000	2,120	12,200	2,010	17,300	2,830	10,800	1,410	10,100	1,160
		12	0.13	14,400	2,360	13,000	2,120	12,200	2,010	17,300	2,830	10,800	1,410	10,100	1,160
		16	0.1	14,400	2,360	13,000	2,120	12,200	2,010	17,300	2,830	10,800	1,410	10,100	1,160
		20	0.1	11,700	1,910	10,500	1,720	9,900	1,620	14,000	2,290	8,700	1,270	8,200	1,040
		25	0.09	11,700	1,910	10,500	1,720	9,900	1,620	14,000	2,290	8,700	1,270	8,200	1,040
		30	0.08	9,100	1,910	8,200	1,720	7,700	1,620	10,900	2,290	6,800	1,270	6,400	1,040
		35	0.065	9,100	1,910	8,200	1,720	7,700	1,620	10,900	2,290	6,800	1,270	6,400	1,040

【Note】 Please refer to P625

Recommended Cutting Data (High Precision)

SPM200-RN4/SHM200-RN4

4 Flute, Corner Radius

» Continuation

Micro Diameter Endmills for Deep Machining

Workpiece Material				P						N		H			
				Carbon Steel, Alloy Steel (180~250HB)		Alloy Steel, Tool Steel (25~35HRC)		PH, Ferrite, Martensite Steel (35~45HRC)		Copper, Copper Alloys		Hardened Steel (45~55HRC)		Hardened Steel (55~65HRC)	
Ratio to standard depth of cut(ap)				1.00		0.90		0.80		1.20		0.65		0.60	
Mill Dia. (mm)	r (mm)	Under Neck Length (mm)	ap	n r/min	Vf mm/min	n r/min	Vf mm/min	n r/min	Vf mm/min	n r/min	Vf mm/min	n r/min	Vf mm/min	n r/min	Vf mm/min
4	0.1	12	0.065	10,400	2,790	9,300	2,520	8,800	2,240	12,400	3,350	7,800	1,750	7,200	1,300
		20	0.055	10,400	2,790	9,300	2,520	8,800	2,240	12,400	3,350	7,800	1,750	7,200	1,300
		30	0.045	9,300	2,520	8,400	2,010	7,900	1,830	11,200	3,020	7,000	1,470	6,500	1,170
		40	0.03	9,300	2,520	8,400	2,010	7,900	1,830	11,200	3,020	7,000	1,470	6,500	1,170
	0.2	12	0.13	10,400	2,790	9,300	2,520	8,800	2,240	12,400	3,350	7,800	1,750	7,200	1,300
		20	0.1	10,400	2,790	9,300	2,520	8,800	2,240	12,400	3,350	7,800	1,750	7,200	1,300
		30	0.08	9,300	2,520	8,400	2,010	7,900	1,830	11,200	3,020	7,000	1,470	6,500	1,170
		40	0.06	9,300	2,520	8,400	2,010	7,900	1,830	11,200	3,020	7,000	1,470	6,500	1,170
	0.3	12	0.17	10,400	2,790	9,300	2,520	8,800	2,380	12,400	3,350	7,800	1,860	7,200	1,410
		20	0.13	10,400	2,790	9,300	2,520	8,800	2,380	12,400	3,350	7,800	1,860	7,200	1,410
		30	0.1	9,300	2,520	8,400	2,260	7,900	1,900	11,200	3,020	7,000	1,570	6,500	1,170
		40	0.08	9,300	2,520	8,400	2,260	7,900	1,900	11,200	3,020	7,000	1,570	6,500	1,170
	0.5	12	0.24	10,400	2,790	9,300	2,520	8,800	2,380	12,400	3,350	7,800	1,860	7,200	1,410
		20	0.2	10,400	2,790	9,300	2,520	8,800	2,380	12,400	3,350	7,800	1,860	7,200	1,410
		30	0.17	9,300	2,520	8,400	2,260	7,900	1,900	11,200	3,020	7,000	1,570	6,500	1,170
		40	0.1	9,300	2,520	8,400	2,260	7,900	1,900	11,200	3,020	7,000	1,570	6,500	1,170
5	0.1	20	0.07	8,100	2,190	7,300	1,970	6,900	1,760	9,700	2,620	6,100	1,370	5,700	1,020
		40	0.035	7,300	1,970	6,600	1,570	6,200	1,430	8,700	2,360	5,500	1,150	5,100	920
	0.2	20	0.15	8,100	2,190	7,300	1,970	6,900	1,760	9,700	2,620	6,100	1,370	5,700	1,020
		40	0.08	7,300	1,970	6,600	1,570	6,200	1,430	8,700	2,360	5,500	1,150	5,100	920
	0.3	20	0.21	8,100	2,190	7,300	1,970	6,900	1,860	9,700	2,620	6,100	1,460	5,700	1,110
		40	0.1	7,300	1,970	6,600	1,770	6,200	1,490	8,700	2,360	5,500	1,230	5,100	920
	0.5	20	0.28	8,100	2,190	7,300	1,970	6,900	1,860	9,700	2,620	6,100	1,460	5,700	1,110
		40	0.14	7,300	1,970	6,600	1,770	6,200	1,490	8,700	2,360	5,500	1,230	5,100	920
1	20	0.35	8,100	2,190	7,300	1,970	6,900	1,860	9,700	2,620	6,100	1,460	5,700	1,110	
	40	0.18	7,300	1,970	6,600	1,770	6,200	1,490	8,700	2,360	5,500	1,230	5,100	920	

【Note】 Please refer to P625

Recommended Cutting Data (High Precision)

SPM200-RN4/SHM200-RN4

4 Flute, Corner Radius

» Continuation

Micro Diameter Endmills for Deep Machining

Workpiece Material				P						N		H			
				Carbon Steel, Alloy Steel (180~250HB)		Alloy Steel, Tool Steel (25~35HRC)		PH,Ferrite, Martensite Steel (35~45HRC)		Copper, Copper Alloys		Hardened Steel (45~55HRC)		Hardened Steel (55~65HRC)	
Ratio to standard depth of cut(ap)				1.00		0.90		0.80		1.20		0.65		0.60	
Mill Dia. (mm)	r (mm)	Under Neck Length (mm)	ap	n r/min	Vf mm/min	n r/min	Vf mm/min	n r/min	Vf mm/min	n r/min	Vf mm/min	n r/min	Vf mm/min	n r/min	Vf mm/min
6	0.2	30	0.15	7,200	1,940	6,500	1,750	6,100	1,560	8,600	2,330	5,400	1,220	5,000	910
		54	0.1	6,500	1,750	5,800	1,400	5,500	1,270	7,800	2,100	4,900	1,020	4,500	820
		72	0.07	6,500	1,750	5,800	1,400	5,500	1,270	7,800	2,100	4,900	1,020	4,500	820
	0.3	30	0.25	7,200	1,940	6,500	1,750	6,100	1,560	8,600	2,330	5,400	1,300	5,000	980
		54	0.18	6,500	1,750	5,800	1,570	5,500	1,270	7,800	2,100	4,900	1,090	4,500	820
		72	0.1	6,500	1,750	5,800	1,570	5,500	1,270	7,800	2,100	4,900	1,090	4,500	820
	0.5	30	0.35	7,200	1,940	6,500	1,750	6,100	1,650	8,600	2,330	5,400	1,300	5,000	980
		54	0.25	6,500	1,750	5,800	1,570	5,500	1,320	7,800	2,100	4,900	1,090	4,500	820
		72	0.15	6,500	1,750	5,800	1,570	5,500	1,320	7,800	2,100	4,900	1,090	4,500	820
	1	30	0.55	7,200	1,940	6,500	1,750	6,100	1,650	8,600	2,330	5,400	1,300	5,000	980
		54	0.4	6,500	1,750	5,800	1,570	5,500	1,320	7,800	2,100	4,900	1,090	4,500	820
		72	0.22	6,500	1,750	5,800	1,570	5,500	1,320	7,800	2,100	4,900	1,090	4,500	820

【Note】

- For different materials, adjust the cutting depth (ap) according to the cutting depth factors in the above table. E.g. for hardened Steel (45~55HRC), $ap \times 0.5$.
- Use the appropriate coolant such as air cooling or emulsion for the work material and machining shape.
- In actual machining, the condition should be adjusted according to the machining shape, purpose and the machine type.
- If the rpm of the machine is lower than the data in the above table, the feed rate should also be lowered in the same ratio.

Recommended Cutting Data (General Type)

SPM200-BN2/SHM200-BN2

2 Flute, Ballnose

Micro Diameter Endmills for Deep Machining

Workpiece Material				P				N		H					
				Carbon Steel, Alloy Steel (180~250HB)		Alloy Steel, Tool Steel (25~35HRC)		PH,Ferrite, Martensite Steel (35~45HRC)		Copper, Copper Alloys		Hardened Steel (45~55HRC)		Hardened Steel (55~65HRC)	
Ratio to standard depth of cut(ap)				1.00		0.90		0.80		1.20		0.65		0.60	
R (mm)	Mill Dia. (mm)	Under Neck Length (mm)	ap	n r/min	Vf mm/min	n r/min	Vf mm/min	n r/min	Vf mm/min	n r/min	Vf mm/min	n r/min	Vf mm/min	n r/min	Vf mm/min
0.05	0.1	0.2	0.008	50,000	250	50,000	250	50,000	225	50,000	300	50,000	200	50,000	188
		0.3	0.006	50,000	250	50,000	250	50,000	225	50,000	300	50,000	200	50,000	188
		0.5	0.004	50,000	250	50,000	250	50,000	225	50,000	300	50,000	200	50,000	188
0.1	0.2	0.5	0.02	45,000	315	45,000	315	45,000	293	45,000	378	40,950	246	37,800	189
		0.75	0.017	45,000	315	45,000	315	45,000	293	45,000	378	40,950	246	37,800	189
		1	0.014	45,000	315	45,000	315	45,000	293	45,000	378	40,950	246	37,800	189
		1.25	0.011	45,000	284	43,740	275	41,310	242	45,000	340	36,450	197	34,020	153
		1.5	0.008	45,000	284	43,740	275	41,310	242	45,000	340	36,450	197	34,020	153
		2	0.008	45,000	284	43,740	275	41,310	242	45,000	340	36,450	197	34,020	153
		2.5	0.006	43,200	242	38,880	218	36,720	191	43,200	291	32,400	156	30,240	121
3	0.004	43,200	242	38,880	218	36,720	191	43,200	291	32,400	156	30,240	121		
0.15	0.3	0.5	0.027	45,000	450	45,000	450	45,000	405	45,000	540	40,500	345	37,800	302
		0.75	0.024	45,000	450	45,000	450	45,000	405	45,000	540	40,500	345	37,800	302
		1	0.021	45,000	450	45,000	450	45,000	405	45,000	540	40,500	345	37,800	302
		1.25	0.019	45,000	450	45,000	450	45,000	405	45,000	540	40,500	345	37,800	302
		1.5	0.016	45,000	450	45,000	450	45,000	405	45,000	540	40,500	345	37,800	302
		2	0.012	45,000	405	43,740	393	41,310	335	45,000	486	36,450	279	34,020	245
		2.5	0.01	45,000	405	43,740	393	41,310	335	45,000	486	36,450	279	34,020	245
3	0.008	45,000	405	43,740	393	41,310	335	45,000	486	36,450	279	34,020	245		
0.2	0.4	0.75	0.043	45,000	756	45,000	755	45,000	693	45,000	870	42,120	590	39,312	551
		1	0.04	45,000	756	45,000	755	45,000	693	45,000	870	42,120	590	39,312	551
		1.5	0.034	45,000	648	45,000	647	45,000	594	45,000	746	42,120	421	39,312	393
		2	0.028	45,000	540	45,000	540	45,000	495	45,000	622	42,120	421	39,312	393
		2.5	0.022	38,880	420	34,992	378	33,048	328	45,000	504	29,160	263	32,659	245
		3	0.016	38,880	420	34,992	378	33,048	328	45,000	504	29,160	263	32,659	245
		3.5	0.012	38,880	420	34,992	378	33,048	328	45,000	504	29,160	263	32,659	245
		4	0.01	38,880	420	34,992	378	33,048	328	45,000	504	29,160	263	32,659	245
4.5	0.008	34,560	353	31,104	318	29,376	275	41,472	423	25,920	221	24,192	205		
0.25	0.5	1	0.045	45,000	1,350	42,120	1,264	39,780	1,074	45,000	1,350	35,100	948	32,760	669
		1.5	0.04	45,000	1,350	42,120	1,264	39,780	1,074	45,000	1,350	35,100	948	32,760	613
		2	0.035	45,000	1,080	42,120	1,011	39,780	860	45,000	1,080	35,100	758	32,760	613
		2.5	0.033	45,000	900	37,908	682	35,802	581	45,000	973	31,590	511	29,484	452

【Note】 Please refer to P636

Recommended Cutting Data (General Type)

SPM200-BN2/SHM200-BN2

2 Flute, Ballnose

» Continuation

Micro Diameter Endmills for Deep Machining

Workpiece Material				P						N		H			
				Carbon Steel, Alloy Steel (180~250HB)		Alloy Steel, Tool Steel (25~35HRC)		PH,Ferrite, Martensite Steel (35~45HRC)		Copper, Copper Alloys		Hardened Steel (45~55HRC)		Hardened Steel (55~65HRC)	
Ratio to standard depth of cut(ap)				1.00		0.90		0.80		1.20		0.65		0.60	
R (mm)	Mill Dia. (mm)	Under Neck Length (mm)	ap	n r/min	Vf mm/min	n r/min	Vf mm/min	n r/min	Vf mm/min	n r/min	Vf mm/min	n r/min	Vf mm/min	n r/min	Vf mm/min
0.25	0.5	3	0.03	42,120	758	37,908	682	35,802	581	45,000	810	31,590	511	22,680	347
		4	0.02	32,400	583	29,160	525	27,540	446	38,880	700	29,160	472	22,680	347
		5	0.018	32,400	583	29,160	525	27,540	446	38,880	700	29,160	472	22,680	347
		5.5	0.015	28,800	490	25,920	441	24,480	374	34,560	588	21,600	330	20,160	292
		6	0.013	28,800	490	25,920	441	24,480	374	34,560	588	21,600	330	20,160	292
		8	0.008	28,800	490	25,920	441	24,480	374	34,560	588	21,600	330	20,160	292
0.3	0.6	1	0.075	45,000	2,025	45,000	2,025	45,000	1,755	45,000	2,025	43,200	1,555	40,320	1,210
		2	0.063	45,000	2,025	45,000	2,025	45,000	1,755	45,000	2,025	43,200	1,555	40,320	1,210
		2.5	0.046	45,000	1,620	45,000	1,620	45,000	1,404	45,000	1,620	43,200	1,244	40,320	887
		3	0.041	45,000	1,620	45,000	1,620	45,000	1,404	45,000	1,620	43,200	1,244	40,320	887
		3.5	0.035	45,000	1,539	45,000	1,538	44,064	1,307	45,000	1,539	38,880	1,065	36,288	759
		4	0.026	45,000	1,539	45,000	1,538	44,064	1,307	45,000	1,539	38,880	1,065	36,288	689
		4.5	0.022	45,000	1,215	43,740	1,182	41,310	967	45,000	1,215	36,450	788	34,020	613
		5	0.02	42,120	1,138	37,908	1,024	35,802	838	45,000	1,215	31,590	682	29,484	531
		5.5	0.017	42,120	1,138	37,908	1,024	35,802	838	45,000	1,215	31,590	682	29,484	531
		6	0.015	42,120	1,138	37,908	1,024	35,802	838	45,000	1,215	31,590	682	29,484	531
		7	0.015	28,800	734	25,920	793	24,480	541	34,560	881	21,600	441	20,160	446
		8	0.015	28,800	734	25,920	661	24,480	541	34,560	881	21,600	441	20,160	343
9	0.012	28,800	734	25,920	661	24,480	541	34,560	881	21,600	441	20,160	343		
10	0.009	25,200	643	22,680	579	21,420	473	30,240	771	18,900	385	17,640	300		
12	0.007	21,600	518	19,440	466	18,360	382	25,920	622	16,200	311	15,120	242		
0.35	0.7	2	0.092	45,000	2,228	45,000	2,228	45,000	1,940	45,000	2,228	43,200	1,739	37,800	1,069
		4	0.041	45,000	1,692	45,000	1,692	44,064	1,443	45,000	1,692	38,880	1,189	34,020	761
		6	0.027	42,120	1,251	37,908	1,126	35,802	925	45,000	1,337	31,590	763	27,216	577
		8	0.02	28,800	760	25,920	684	24,480	563	34,560	912	21,600	464	20,160	380
0.4	0.8	2	0.12	45,000	2,430	45,000	2,430	45,000	2,160	45,000	2,430	43,200	2,333	40,320	1,694
		4	0.078	45,000	2,430	45,000	2,430	45,000	2,160	45,000	2,430	43,200	2,333	40,320	1,694
		5	0.059	45,000	2,186	45,000	2,188	44,064	1,903	45,000	2,188	38,880	1,911	36,288	1,372
		6	0.042	45,000	2,040	40,824	1,852	38,556	1,554	45,000	2,042	34,020	1,286	31,752	1,121
		8	0.02	37,440	1,213	33,696	1,092	31,824	916	44,928	1,455	28,080	758	26,208	660
		10	0.02	28,800	881	25,920	793	24,480	666	34,560	1,058	21,600	551	20,160	480
0.45	0.9	2	0.135	45,000	2,877	45,000	2,877	45,000	2,539	45,000	2,877	41,040	2,170	38,304	1,924

【Note】 Please refer to P636

Recommended Cutting Data (General Type)

SPM200-BN2/SHM200-BN2

2 Flute, Ballnose

» Continuation

Micro Diameter Endmills for Deep Machining

Workpiece Material				P						N		H			
				Carbon Steel, Alloy Steel (180~250HB)		Alloy Steel, Tool Steel (25~35HRC)		PH,Ferrite, Martensite Steel (35~45HRC)		Copper, Copper Alloys		Hardened Steel (45~55HRC)		Hardened Steel (55~65HRC)	
Ratio to standard depth of cut(ap)				1.00		0.90		0.80		1.20		0.65		0.60	
R (mm)	Mill Dia. (mm)	Under Neck Length (mm)	ap	n r/min	Vf mm/min	n r/min	Vf mm/min	n r/min	Vf mm/min	n r/min	Vf mm/min	n r/min	Vf mm/min	n r/min	Vf mm/min
0.45	0.9	4	0.081	45,000	2,494	45,000	2,494	43,605	2,132	45,000	2,494	38,475	1,763	35,910	1,563
		6	0.05	43,092	1,818	38,783	1,636	36,628	1,364	45,000	2,072	32,319	1,128	30,164	1,000
		8	0.036	32,832	1,259	29,549	1,133	27,907	944	39,398	1,511	24,624	781	22,982	693
0.5	1	2	0.2	45,000	3,375	43,740	3,281	41,310	2,788	45,000	3,375	38,880	2,450	34,020	2,041
		3	0.2	45,000	3,375	43,740	3,281	41,310	2,788	45,000	3,375	38,880	2,450	34,020	2,041
		4	0.14	45,000	3,375	43,740	3,281	41,310	2,788	45,000	3,375	38,880	2,450	34,020	2,041
		5	0.09	42,120	2,948	37,908	2,653	35,802	2,336	45,000	3,150	38,880	2,286	29,484	1,652
		6	0.06	37,908	2,389	36,742	2,302	34,700	2,087	45,000	2,836	34,992	2,118	26,536	1,241
		7	0.06	34,992	1,575	31,493	1,417	29,743	1,204	41,990	1,890	28,431	1,191	24,494	955
		8	0.06	34,992	1,575	31,493	1,417	29,743	1,204	41,990	1,890	28,431	1,191	24,494	881
		9	0.045	34,992	1,575	31,493	1,417	29,743	1,204	41,990	1,890	28,431	1,191	24,494	881
		10	0.038	34,992	1,575	31,493	1,417	29,743	1,204	41,990	1,890	28,431	1,191	24,494	881
		12	0.025	25,920	1,102	23,328	992	22,032	842	31,104	1,322	19,440	694	18,144	617
		13	0.023	25,920	1,102	23,328	992	22,032	842	31,104	1,322	19,440	694	18,144	617
		14	0.02	25,920	1,102	23,328	992	22,032	842	31,104	1,322	19,440	694	18,144	617
		16	0.015	25,920	1,102	23,328	992	22,032	842	31,104	1,322	19,440	694	18,144	617
18	0.012	22,680	907	20,412	816	19,278	694	27,216	1,089	17,010	572	15,876	508		
20	0.01	19,440	778	17,496	700	16,524	595	23,328	933	14,580	490	13,608	436		
0.55	1.1	2	0.2	45,000	3,532	40,824	3,204	38,556	2,634	45,000	3,532	34,020	2,207	31,752	1,958
		4	0.14	45,000	3,532	40,824	3,204	38,556	2,634	45,000	3,532	34,020	2,207	31,752	1,958
		6	0.06	35,802	2,075	32,222	1,868	30,432	1,535	42,962	2,490	26,852	1,287	25,061	1,141
		8	0.06	35,802	2,075	32,222	1,556	28,091	1,181	42,962	2,075	24,786	990	23,134	878
		10	0.038	35,802	1,597	32,222	1,556	28,091	1,181	42,962	2,075	24,786	990	23,134	878
0.6	1.2	4	0.16	41,539	3,369	37,384	2,934	35,307	2,445	45,000	3,532	33,231	2,300	29,076	1,674
		8	0.06	33,696	1,928	30,326	1,893	28,642	1,862	40,435	2,313	27,216	1,856	23,587	943
		10	0.053	31,104	1,537	27,994	1,310	26,438	1,190	37,325	1,746	24,300	962	21,773	784
		12	0.045	31,104	1,456	27,994	1,310	26,438	1,190	37,325	1,746	23,328	923	21,773	784
0.7	1.4	8	0.11	29,484	2,123	26,536	1,911	25,061	1,625	35,381	2,547	22,113	1,380	20,639	1,238
		12	0.053	27,216	1,470	24,494	1,323	23,134	1,124	32,659	1,764	20,412	956	19,051	858
		16	0.035	20,160	1,028	18,144	925	17,136	787	24,192	1,234	15,120	669	14,112	599
0.75	1.5	4	0.2	37,800	3,742	34,020	3,368	32,130	2,892	45,000	4,456	28,350	2,297	26,460	1,985
		6	0.2	37,800	3,742	34,020	3,368	32,130	2,892	45,000	4,456	28,350	2,297	26,460	1,985
		8	0.09	29,484	2,364	26,536	1,891	25,061	1,625	35,381	2,522	22,113	1,291	20,639	1,115

[Note] Please refer to P636

Recommended Cutting Data (General Type)

SPM200-BN2/SHM200-BN2

2 Flute, Ballnose

Micro Diameter Endmills for Deep Machining

» Continuation

Workpiece Material				P						N		H			
				Carbon Steel, Alloy Steel (180~250HB)		Alloy Steel, Tool Steel (25~35HRC)		PH,Ferrite, Martensite Steel (35~45HRC)		Copper, Copper Alloys		Hardened Steel (45~55HRC)		Hardened Steel (55~65HRC)	
Ratio to standard depth of cut(ap)				1.00		0.90		0.80		1.20		0.65		0.60	
R (mm)	Mill Dia. (mm)	Under Neck Length (mm)	ap	n r/min	Vf mm/min	n r/min	Vf mm/min	n r/min	Vf mm/min	n r/min	Vf mm/min	n r/min	Vf mm/min	n r/min	Vf mm/min
0.75	1.5	10	0.09	27,216	1,940	24,494	1,746	23,134	1,499	32,659	2,327	20,412	1,191	19,051	1,029
		12	0.09	27,216	1,616	24,494	1,454	23,134	1,249	32,659	1,940	20,412	993	19,051	858
		14	0.075	27,216	1,616	21,773	1,221	20,563	1,049	29,030	1,629	18,144	833	16,934	719
		16	0.038	20,160	1,131	18,144	1,018	17,136	874	24,192	1,357	15,120	694	14,112	599
		18	0.038	20,160	1,131	18,144	1,018	17,136	874	24,192	1,357	15,120	694	14,112	599
		20	0.038	20,160	1,131	18,144	1,018	17,136	874	24,192	1,357	15,120	694	14,112	599
0.8	1.6	8	0.22	32,760	2,752	29,484	2,477	27,846	2,244	39,312	3,302	24,570	1,916	21,294	1,431
		12	0.098	29,484	2,600	26,536	2,341	25,061	1,958	35,381	3,120	22,113	1,672	19,165	1,160
		16	0.06	25,272	1,592	22,745	1,433	21,481	1,199	30,326	1,911	18,954	1,024	17,690	892
		20	0.04	18,720	1,114	16,848	1,003	15,912	839	22,464	1,337	14,040	716	13,104	624
0.9	1.8	8	0.26	30,420	2,921	27,378	2,628	25,857	2,172	36,504	3,505	22,815	1,807	21,294	1,534
		12	0.105	25,272	1,820	22,745	1,637	21,481	1,354	30,326	2,183	18,954	1,125	17,690	956
		16	0.068	25,272	1,820	22,745	1,637	21,481	1,354	30,326	2,183	18,954	1,125	17,690	956
		20	0.045	18,720	1,273	16,848	1,146	15,912	947	22,464	1,527	14,040	788	13,104	669
1	2	3	0.4	28,350	4,253	25,515	3,828	24,098	3,254	34,020	5,103	21,263	2,744	19,845	2,381
		4	0.4	28,350	4,253	25,515	3,828	24,098	3,254	34,020	5,103	21,263	2,744	19,845	2,381
		6	0.4	28,350	3,828	25,515	3,444	24,098	2,892	34,020	4,593	21,263	2,424	19,845	2,143
		8	0.28	28,350	3,828	25,515	3,444	24,098	2,892	34,020	4,593	21,263	2,424	19,845	2,143
		10	0.21	26,460	3,175	23,814	2,858	22,491	2,429	31,752	3,811	19,845	2,024	17,199	1,321
		12	0.12	23,814	2,858	21,433	2,572	20,242	2,187	28,577	3,428	17,861	1,846	15,479	1,189
		13	0.12	23,814	2,858	21,433	2,572	20,242	2,187	28,577	3,428	17,861	1,822	14,288	914
		14	0.12	23,814	2,477	21,433	2,229	20,242	1,895	28,577	2,971	16,585	1,466	14,288	914
		16	0.12	22,113	1,592	19,902	1,434	18,797	1,218	26,536	1,911	16,585	1,320	14,288	823
		18	0.09	20,412	1,470	18,371	1,323	17,350	1,124	24,494	1,764	16,585	1,219	14,288	823
		20	0.075	20,412	1,470	18,371	1,323	17,350	1,124	24,494	1,764	16,585	1,015	14,288	823
		22	0.05	16,065	1,093	14,459	983	13,656	836	19,278	1,311	12,049	697	13,495	734
		25	0.05	15,120	1,028	13,608	925	12,852	787	18,144	1,234	11,340	655	12,701	691
		30	0.03	15,120	1,028	13,608	925	12,852	787	18,144	1,234	11,340	655	12,701	691
35	0.025	13,230	847	11,907	762	11,246	648	15,876	1,016	9,923	540	9,261	474		
40	0.022	11,340	725	10,206	653	9,639	555	13,608	871	8,505	463	7,938	407		
1.25	2.5	6	0.5	24,975	4,557	22,478	4,100	21,229	3,417	29,970	5,468	18,732	2,779	17,483	2,278
		10	0.34	24,975	4,557	22,478	4,100	21,229	3,417	29,970	5,468	18,732	2,779	17,483	2,278
		15	0.15	19,481	2,558	17,533	2,302	16,558	1,919	23,377	3,070	14,611	1,821	13,637	1,279

【Note】 Please refer to P636

Recommended Cutting Data (General Type)

SPM200-BN2/SHM200-BN2

2 Flute, Ballnose

» Continuation

Micro Diameter Endmills for Deep Machining

Workpiece Material				P						N		H			
				Carbon Steel, Alloy Steel (180~250HB)		Alloy Steel, Tool Steel (25~35HRC)		PH,Ferrite, Martensite Steel (35~45HRC)		Copper, Copper Alloys		Hardened Steel (45~55HRC)		Hardened Steel (55~65HRC)	
Ratio to standard depth of cut(ap)				1.00		0.90		0.80		1.20		0.65		0.60	
R (mm)	Mill Dia. (mm)	Under Neck Length (mm)	ap	n r/min	Vf mm/min	n r/min	Vf mm/min	n r/min	Vf mm/min	n r/min	Vf mm/min	n r/min	Vf mm/min	n r/min	Vf mm/min
1.25	2.5	20	0.12	17,982	1,967	16,184	1,771	15,285	1,476	21,578	2,362	14,611	1,301	12,587	984
		25	0.098	17,982	1,770	16,184	1,593	15,285	1,328	21,578	2,124	13,487	1,080	12,587	885
		30	0.055	13,320	1,377	11,988	1,239	11,322	1,033	15,984	1,652	9,990	840	9,324	689
1.5	3	8	0.6	21,600	4,860	19,440	4,374	18,360	3,690	25,920	5,832	16,200	3,062	15,120	2,722
		10	0.42	21,600	4,860	19,440	4,374	18,360	3,690	25,920	5,832	16,200	3,062	15,120	2,722
		13	0.315	20,160	3,629	18,144	3,266	17,136	2,755	24,192	4,354	15,120	2,286	14,112	2,032
		16	0.315	20,160	3,266	18,144	2,939	17,136	2,480	24,192	3,920	15,120	2,057	13,104	1,699
		20	0.18	16,848	2,274	15,163	2,048	14,321	1,727	20,218	2,730	12,636	1,434	10,886	1,176
		25	0.12	16,848	2,274	15,163	2,048	14,321	1,727	20,218	2,730	12,636	1,434	10,886	1,176
		30	0.12	15,552	2,100	13,997	1,890	13,219	1,594	18,662	2,520	11,664	1,323	10,886	1,176
		35	0.08	11,520	1,469	10,368	1,322	9,792	1,115	13,824	1,762	8,640	925	9,677	987
1.75	3.5	15	0.36	16,088	3,299	14,479	2,969	13,675	2,475	19,305	3,959	12,065	2,012	11,262	1,650
		25	0.21	13,365	2,052	12,029	1,847	11,361	1,539	16,038	2,462	10,024	1,252	9,356	1,026
		35	0.09	13,365	2,052	12,029	1,847	11,361	1,539	16,038	2,462	10,024	1,252	9,356	1,026
		45	0.09	9,900	1,438	8,910	1,294	8,415	1,079	11,880	1,726	7,425	878	6,930	719
2	4	10	0.6	15,525	4,658	13,973	4,192	13,197	3,564	18,630	5,589	11,644	2,969	10,868	2,608
		13	0.48	15,525	4,658	13,973	4,192	13,197	3,564	18,630	5,589	11,644	2,969	10,868	2,608
		16	0.42	15,525	4,658	13,973	4,192	13,197	3,564	18,630	5,589	11,644	2,969	10,868	2,608
		20	0.42	13,455	3,229	12,110	2,906	11,437	2,471	16,146	3,875	10,092	2,058	9,419	1,808
		25	0.24	12,110	2,615	10,899	2,354	10,293	2,001	14,531	3,139	9,083	1,946	8,477	1,464
		30	0.16	11,178	2,012	10,060	1,811	9,502	1,539	13,414	2,415	8,384	1,283	7,825	1,127
		35	0.1	11,178	2,012	10,060	1,811	9,502	1,539	13,414	2,415	8,384	1,283	7,825	1,127
		40	0.1	11,178	2,012	10,060	1,811	9,502	1,539	13,414	2,415	8,384	1,283	7,825	1,127
		45	0.1	8,280	1,408	7,452	1,267	7,038	1,076	9,936	1,689	6,210	897	5,796	788
		50	0.1	8,280	1,408	7,452	1,267	7,038	1,076	9,936	1,689	6,210	897	5,796	788
2.5	5	20	0.525	11,340	4,082	10,206	3,674	9,639	2,892	13,608	4,899	8,505	2,552	7,938	2,143
		25	0.525	10,530	3,285	9,477	3,412	8,951	2,686	12,636	4,549	7,898	2,370	7,371	1,990
		30	0.3	9,477	2,502	8,529	3,072	8,056	2,417	11,372	4,094	7,108	2,132	6,634	1,792
		40	0.2	8,748	1,890	7,873	1,701	7,436	1,338	10,498	2,268	6,561	1,182	6,124	993
3	6	12	0.6	12,150	5,103	10,935	4,593	10,328	3,828	14,580	6,124	9,113	3,113	8,505	2,552
		20	0.5	11,475	4,476	10,328	4,028	9,754	3,356	13,770	5,370	8,607	2,730	8,033	2,237
		30	0.42	9,360	2,696	8,424	2,426	7,956	1,910	11,232	3,235	7,020	1,825	6,552	1,415
		50	0.15	7,776	2,015	6,998	1,814	6,610	1,428	9,331	2,418	5,832	1,260	5,443	1,058

【Note】 Please refer to P636

Recommended Cutting Data (High Precision)

SPM200-BN2/SHM200-BN2

2 Flute, Ballnose

Micro Diameter Endmills for Deep Machining

» Continuation

Workpiece Material				P						N		H			
				Carbon Steel, Alloy Steel (180~250HB)		Alloy Steel, Tool Steel (25~35HRC)		PH,Ferrite, Martensite Steel (35~45HRC)		Copper, Copper Alloys		Hardened Steel (45~55HRC)		Hardened Steel (55~65HRC)	
Ratio to standard depth of cut(ap)				1.00		0.90		0.80		1.20		0.65		0.60	
R (mm)	Mill Dia. (mm)	Under Neck Length (mm)	ap	n r/min	Vf mm/min	n r/min	Vf mm/min	n r/min	Vf mm/min	n r/min	Vf mm/min	n r/min	Vf mm/min	n r/min	Vf mm/min
0.05	0.1	0.2	0.004	50,000	250	50,000	250	50,000	225	50,000	300	50,000	200	50,000	188
		0.3	0.003	50,000	250	50,000	250	50,000	225	50,000	300	50,000	200	50,000	188
		0.5	0.002	50,000	250	50,000	250	50,000	225	50,000	300	50,000	200	50,000	188
0.1	0.2	0.5	0.015	45,000	315	45,000	315	45,000	293	45,000	378	40,950	246	37,800	189
		0.75	0.013	45,000	315	45,000	315	45,000	293	45,000	378	40,950	246	37,800	189
		1	0.011	45,000	315	45,000	315	45,000	293	45,000	378	40,950	246	37,800	189
		1.25	0.008	45,000	284	43,740	275	41,310	242	45,000	340	36,450	197	34,020	153
		1.5	0.007	45,000	284	43,740	275	41,310	242	45,000	340	36,450	197	34,020	153
		2	0.006	45,000	284	43,740	275	41,310	242	45,000	340	36,450	197	34,020	153
		2.5	0.005	43,200	242	38,880	218	36,720	191	43,200	291	32,400	156	30,240	121
3	0.003	43,200	242	38,880	218	36,720	191	43,200	291	32,400	156	30,240	121		
0.15	0.3	0.5	0.02	45,000	450	45,000	450	45,000	405	45,000	540	40,500	345	37,800	302
		0.75	0.018	45,000	450	45,000	450	45,000	405	45,000	540	40,500	345	37,800	302
		1	0.016	45,000	450	45,000	450	45,000	405	45,000	540	40,500	345	37,800	302
		1.25	0.014	45,000	450	45,000	450	45,000	405	45,000	540	40,500	345	37,800	302
		1.5	0.012	45,000	450	45,000	450	45,000	405	45,000	540	40,500	345	37,800	302
		2	0.009	45,000	405	43,740	393	41,310	335	45,000	486	36,450	279	34,020	245
		2.5	0.008	45,000	405	43,740	393	41,310	335	45,000	486	36,450	279	34,020	245
3	0.006	45,000	405	43,740	393	41,310	335	45,000	486	36,450	279	34,020	245		
0.2	0.4	0.75	0.043	43,200	518	38,880	466	36,720	404	45,000	622	32,400	324	30,240	302
		1	0.04	43,200	518	38,880	466	36,720	404	45,000	622	32,400	324	30,240	302
		1.5	0.034	43,200	518	38,880	466	36,720	404	45,000	622	32,400	324	30,240	302
		2	0.028	43,200	518	38,880	466	36,720	404	45,000	622	32,400	324	30,240	302
		2.5	0.016	38,880	420	34,992	378	33,048	328	45,000	504	29,160	263	27,216	245
		3	0.011	38,880	420	34,992	378	33,048	328	45,000	504	29,160	263	27,216	245
		3.5	0.008	38,880	420	34,992	378	33,048	328	45,000	504	29,160	263	27,216	245
		4	0.005	38,880	420	34,992	378	33,048	328	45,000	504	29,160	263	27,216	245
4.5	0.004	34,560	353	31,104	318	29,376	275	41,472	423	25,920	221	24,192	205		
0.25	0.5	1	0.045	36,000	720	32,400	648	30,600	551	43,200	864	27,000	486	25,200	428
		1.5	0.04	36,000	720	32,400	648	30,600	551	43,200	864	27,000	486	25,200	428
		2	0.035	36,000	720	32,400	648	30,600	551	43,200	864	27,000	486	25,200	428
		2.5	0.033	36,000	720	29,160	525	27,540	446	38,880	700	24,300	393	22,680	347

【Note】 Please refer to P636

Recommended Cutting Data (High Precision)

SPM200-BN2/SHM200-BN2

2 Flute, Ballnose

» Continuation

Micro Diameter Endmills for Deep Machining

Workpiece Material				P				N		H					
				Carbon Steel, Alloy Steel (180~250HB)		Alloy Steel, Tool Steel (25~35HRC)		PH,Ferrite, Martensite Steel (35~45HRC)		Copper, Copper Alloys		Hardened Steel (45~55HRC)		Hardened Steel (55~65HRC)	
Ratio to standard depth of cut(ap)				1.00		0.90		0.80		1.20		0.65		0.60	
R (mm)	Mill Dia. (mm)	Under Neck Length (mm)	ap	n r/min	Vf mm/min	n r/min	Vf mm/min	n r/min	Vf mm/min	n r/min	Vf mm/min	n r/min	Vf mm/min	n r/min	Vf mm/min
0.25	0.5	3	0.03	32,400	583	29,160	525	27,540	446	38,880	700	24,300	393	22,680	347
		4	0.02	32,400	583	29,160	525	27,540	446	38,880	700	24,300	393	22,680	347
		5	0.018	32,400	583	29,160	525	27,540	446	38,880	700	24,300	393	22,680	347
		5.5	0.008	28,800	490	25,920	441	24,480	374	34,560	588	21,600	330	20,160	292
		6	0.007	28,800	490	25,920	441	24,480	374	34,560	588	21,600	330	20,160	292
		8	0.004	28,800	490	25,920	441	24,480	374	34,560	588	21,600	330	20,160	292
0.3	0.6	1	0.05	36,000	1,080	32,400	972	30,600	796	43,200	1,296	27,000	648	25,200	504
		2	0.042	36,000	1,080	32,400	972	30,600	796	43,200	1,296	27,000	648	25,200	504
		2.5	0.038	36,000	1,080	32,400	972	30,600	796	43,200	1,296	27,000	648	25,200	504
		3	0.034	36,000	1,080	32,400	972	30,600	796	43,200	1,296	27,000	648	25,200	504
		3.5	0.029	32,400	923	29,160	831	27,540	680	38,880	1,108	24,300	554	22,680	431
		4	0.024	32,400	923	29,160	831	27,540	680	38,880	1,108	24,300	554	22,680	431
		4.5	0.022	32,400	875	29,160	788	27,540	644	38,880	1,049	24,300	525	22,680	409
		5	0.02	32,400	875	29,160	788	27,540	644	38,880	1,049	24,300	525	22,680	409
		5.5	0.017	32,400	875	29,160	788	27,540	644	38,880	1,049	24,300	525	22,680	409
		6	0.015	32,400	875	29,160	788	27,540	644	38,880	1,049	24,300	525	22,680	409
		7	0.008	28,800	734	25,920	661	24,480	541	34,560	881	21,600	441	20,160	343
		8	0.008	28,800	734	25,920	661	24,480	541	34,560	881	21,600	441	20,160	343
9	0.006	28,800	734	25,920	661	24,480	541	34,560	881	21,600	441	20,160	343		
10	0.005	25,200	643	22,680	579	21,420	473	30,240	771	18,900	385	17,640	300		
12	0.004	21,600	518	19,440	466	18,360	382	25,920	622	16,200	311	15,120	242		
0.35	0.7	2	0.061	36,000	1,188	32,400	1,069	30,600	879	43,200	1,426	27,000	725	25,200	594
		4	0.034	32,400	1,015	29,160	914	27,540	752	38,880	1,219	24,300	619	22,680	508
		6	0.027	32,400	962	29,160	866	27,540	712	38,880	1,155	24,300	587	22,680	482
		8	0.01	28,800	760	25,920	684	24,480	563	34,560	912	21,600	464	20,160	380
0.4	0.8	2	0.08	36,000	1,296	32,400	1,166	30,600	979	43,200	1,555	27,000	810	25,200	706
		4	0.056	36,000	1,296	32,400	1,166	30,600	979	43,200	1,555	27,000	810	25,200	706
		5	0.045	32,400	1,049	29,160	945	27,540	793	38,880	1,260	24,300	656	22,680	572
		6	0.032	32,400	1,049	29,160	945	27,540	793	38,880	1,260	24,300	656	22,680	572
		8	0.02	28,800	933	25,920	840	24,480	705	34,560	1,120	21,600	583	20,160	508
10	0.01	28,800	881	25,920	793	24,480	666	34,560	1,058	21,600	551	20,160	480		
0.45	0.9	2	0.09	34,200	1,458	30,780	1,312	29,070	1,094	41,040	1,750	25,650	904	23,940	802

【Note】 Please refer to P636

Recommended Cutting Data (High Precision)

SPM200-BN2/SHM200-BN2

2 Flute, Ballnose

» Continuation

Micro Diameter Endmills for Deep Machining

Workpiece Material				P						N		H			
				Carbon Steel, Alloy Steel (180~250HB)		Alloy Steel, Tool Steel (25~35HRC)		PH,Ferrite, Martensite Steel (35~45HRC)		Copper, Copper Alloys		Hardened Steel (45~55HRC)		Hardened Steel (55~65HRC)	
Ratio to standard depth of cut(ap)				1.00		0.90		0.80		1.20		0.65		0.60	
R (mm)	Mill Dia. (mm)	Under Neck Length (mm)	ap	n r/min	Vf mm/min	n r/min	Vf mm/min	n r/min	Vf mm/min	n r/min	Vf mm/min	n r/min	Vf mm/min	n r/min	Vf mm/min
0.45	0.9	4	0.058	34,200	1,458	30,780	1,312	29,070	1,094	41,040	1,750	25,650	904	23,940	802
		6	0.042	30,780	1,181	27,702	1,063	26,163	886	36,936	1,417	23,085	732	21,546	650
		8	0.03	27,360	1,049	24,624	944	23,256	788	32,832	1,259	20,520	651	19,152	577
0.5	1	2	0.1	32,400	1,620	29,160	1,458	27,540	1,239	38,880	1,944	24,300	1,021	22,680	907
		3	0.1	32,400	1,620	29,160	1,458	27,540	1,239	38,880	1,944	24,300	1,021	22,680	907
		4	0.07	32,400	1,620	29,160	1,458	27,540	1,239	38,880	1,944	24,300	1,021	22,680	907
		5	0.06	32,400	1,620	29,160	1,458	27,540	1,239	38,880	1,944	24,300	1,021	22,680	907
		6	0.04	29,160	1,312	26,244	1,181	24,786	1,004	34,992	1,575	21,870	827	20,412	734
		7	0.04	29,160	1,312	26,244	1,181	24,786	1,004	34,992	1,575	21,870	827	20,412	734
		8	0.04	29,160	1,312	26,244	1,181	24,786	1,004	34,992	1,575	21,870	827	20,412	734
		9	0.03	29,160	1,312	26,244	1,181	24,786	1,004	34,992	1,575	21,870	827	20,412	734
		10	0.025	29,160	1,312	26,244	1,181	24,786	1,004	34,992	1,575	21,870	827	20,412	734
		12	0.013	25,920	1,102	23,328	992	22,032	842	31,104	1,322	19,440	694	18,144	617
		13	0.011	25,920	1,102	23,328	992	22,032	842	31,104	1,322	19,440	694	18,144	617
		14	0.01	25,920	1,102	23,328	992	22,032	842	31,104	1,322	19,440	694	18,144	617
		16	0.008	25,920	1,102	23,328	992	22,032	842	31,104	1,322	19,440	694	18,144	617
18	0.006	22,680	907	20,412	816	19,278	694	27,216	1,089	17,010	572	15,876	508		
20	0.005	19,440	778	17,496	700	16,524	595	23,328	933	14,580	490	13,608	436		
0.55	1.1	2	0.1	30,240	1,582	27,216	1,424	25,704	1,171	36,288	1,899	22,680	981	21,168	870
		4	0.07	30,240	1,582	27,216	1,424	25,704	1,171	36,288	1,899	22,680	981	21,168	870
		6	0.04	27,540	1,330	24,786	1,197	23,409	985	33,048	1,597	20,655	824	19,278	732
		8	0.04	27,540	1,330	24,786	1,197	23,409	985	33,048	1,597	20,655	824	19,278	732
		10	0.025	27,540	1,330	24,786	1,197	23,409	985	33,048	1,597	20,655	824	19,278	732
0.6	1.2	4	0.08	27,692	1,449	24,923	1,304	23,539	1,087	33,231	1,739	20,769	898	19,384	797
		8	0.04	25,920	1,348	23,328	1,213	22,032	992	31,104	1,617	19,440	855	18,144	725
		10	0.035	25,920	1,281	23,328	1,092	22,032	992	31,104	1,455	19,440	770	18,144	653
		12	0.03	25,920	1,213	23,328	1,092	22,032	992	31,104	1,455	19,440	770	18,144	653
0.7	1.4	8	0.055	22,680	1,361	20,412	1,225	19,278	1,041	27,216	1,633	17,010	885	15,876	794
		12	0.035	22,680	1,225	20,412	1,103	19,278	937	27,216	1,470	17,010	797	15,876	715
		16	0.017	20,160	1,028	18,144	925	17,136	787	24,192	1,234	15,120	669	14,112	599
0.75	1.5	4	0.1	25,200	1,663	22,680	1,497	21,420	1,285	30,240	1,996	18,900	1,021	17,640	882
		6	0.1	25,200	1,663	22,680	1,497	21,420	1,285	30,240	1,996	18,900	1,021	17,640	882

【Note】 Please refer to P636

Recommended Cutting Data (High Precision)

SPM200-BN2/SHM200-BN2

2 Flute, Ballnose

» Continuation

Micro Diameter Endmills for Deep Machining

Workpiece Material				P						N		H			
				Carbon Steel, Alloy Steel (180~250HB)		Alloy Steel, Tool Steel (25~35HRC)		PH,Ferrite, Martensite Steel (35~45HRC)		Copper, Copper Alloys		Hardened Steel (45~55HRC)		Hardened Steel (55~65HRC)	
Ratio to standard depth of cut(ap)				1.00		0.90		0.80		1.20		0.65		0.60	
R (mm)	Mill Dia. (mm)	Under Neck Length (mm)	ap	n r/min	Vf mm/min	n r/min	Vf mm/min	n r/min	Vf mm/min	n r/min	Vf mm/min	n r/min	Vf mm/min	n r/min	Vf mm/min
0.75	1.5	8	0.06	22,680	1,347	20,412	1,212	19,278	1,041	27,216	1,616	17,010	827	15,876	715
		10	0.06	22,680	1,347	20,412	1,212	19,278	1,041	27,216	1,616	17,010	827	15,876	715
		12	0.06	22,680	1,347	20,412	1,212	19,278	1,041	27,216	1,616	17,010	827	15,876	715
		14	0.05	22,680	1,347	18,144	1,018	17,136	874	24,192	1,357	15,120	694	14,112	599
		16	0.019	20,160	1,131	18,144	1,018	17,136	874	24,192	1,357	15,120	694	14,112	599
		18	0.019	20,160	1,131	18,144	1,018	17,136	874	24,192	1,357	15,120	694	14,112	599
		20	0.019	20,160	1,131	18,144	1,018	17,136	874	24,192	1,357	15,120	694	14,112	599
0.8	1.6	8	0.11	23,400	1,638	21,060	1,474	19,890	1,233	28,080	1,966	17,550	1,053	16,380	917
		12	0.065	21,060	1,327	18,954	1,194	17,901	999	25,272	1,592	15,795	853	14,742	743
		16	0.04	21,060	1,327	18,954	1,194	17,901	999	25,272	1,592	15,795	853	14,742	743
		20	0.02	18,720	1,114	16,848	1,003	15,912	839	22,464	1,337	14,040	716	13,104	624
0.9	1.8	8	0.13	23,400	1,872	21,060	1,685	19,890	1,392	28,080	2,246	17,550	1,158	16,380	983
		12	0.07	21,060	1,517	18,954	1,364	17,901	1,128	25,272	1,820	15,795	938	14,742	797
		16	0.045	21,060	1,517	18,954	1,364	17,901	1,128	25,272	1,820	15,795	938	14,742	797
		20	0.022	18,720	1,273	16,848	1,146	15,912	947	22,464	1,527	14,040	788	13,104	669
1	2	3	0.2	18,900	1,890	17,010	1,701	16,065	1,446	22,680	2,268	14,175	1,220	13,230	1,058
		4	0.2	18,900	1,890	17,010	1,701	16,065	1,446	22,680	2,268	14,175	1,220	13,230	1,058
		6	0.2	18,900	1,701	17,010	1,531	16,065	1,285	22,680	2,041	14,175	1,077	13,230	952
		8	0.14	18,900	1,701	17,010	1,531	16,065	1,285	22,680	2,041	14,175	1,077	13,230	952
		10	0.14	18,900	1,512	17,010	1,361	16,065	1,157	22,680	1,814	14,175	964	13,230	847
		12	0.08	17,010	1,361	15,309	1,225	14,459	1,041	20,412	1,633	12,758	868	11,907	762
		13	0.08	17,010	1,361	15,309	1,225	14,459	1,041	20,412	1,633	12,758	868	11,907	762
		14	0.08	17,010	1,361	15,309	1,225	14,459	1,041	20,412	1,633	12,758	868	11,907	762
		16	0.08	17,010	1,225	15,309	1,103	14,459	937	20,412	1,470	12,758	781	11,907	686
		18	0.06	17,010	1,225	15,309	1,103	14,459	937	20,412	1,470	12,758	781	11,907	686
		20	0.05	17,010	1,225	15,309	1,103	14,459	937	20,412	1,470	12,758	781	11,907	686
		22	0.042	16,065	1,093	14,459	983	13,656	836	19,278	1,311	12,049	697	11,246	612
		25	0.035	15,120	1,028	13,608	925	12,852	787	18,144	1,234	11,340	655	10,584	576
		30	0.015	15,120	1,028	13,608	925	12,852	787	18,144	1,234	11,340	655	10,584	576
35	0.012	13,230	847	11,907	762	11,246	648	15,876	1,016	9,923	540	9,261	474		
40	0.01	11,340	725	10,206	653	9,639	555	13,608	871	8,505	463	7,938	407		
1.25	2.5	6	0.25	16,650	2,025	14,985	1,823	14,153	1,519	19,980	2,430	12,488	1,236	11,655	1,013

【Note】 Please refer to P636

Recommended Cutting Data (High Precision)

SPM200-BN2/SHM200-BN2

2 Flute, Ballnose

» Continuation

Micro Diameter Endmills for Deep Machining

Workpiece Material				P						N		H			
				Carbon Steel, Alloy Steel (180~250HB)		Alloy Steel, Tool Steel (25~35HRC)		PH,Ferrite, Martensite Steel (35~45HRC)		Copper, Copper Alloys		Hardened Steel (45~55HRC)		Hardened Steel (55~65HRC)	
Ratio to standard depth of cut(ap)				1.00		0.90		0.80		1.20		0.65		0.60	
R (mm)	Mill Dia. (mm)	Under Neck Length (mm)	ap	n r/min	Vf mm/min	n r/min	Vf mm/min	n r/min	Vf mm/min	n r/min	Vf mm/min	n r/min	Vf mm/min	n r/min	Vf mm/min
1.25	2.5	10	0.17	16,650	2,025	14,985	1,823	14,153	1,519	19,980	2,430	12,488	1,236	11,655	1,013
		15	0.1	14,985	1,640	13,487	1,476	12,738	1,230	17,982	1,967	11,239	1,000	10,490	820
		20	0.08	14,985	1,640	13,487	1,476	12,738	1,230	17,982	1,967	11,239	1,000	10,490	820
		25	0.065	14,985	1,475	13,487	1,328	12,738	1,106	17,982	1,770	11,239	900	10,490	738
		30	0.044	13,320	1,377	11,988	1,239	11,322	1,033	15,984	1,652	9,990	840	9,324	689
1.5	3	8	0.3	14,400	2,160	12,960	1,944	12,240	1,640	17,280	2,592	10,800	1,361	10,080	1,210
		10	0.21	14,400	2,160	12,960	1,944	12,240	1,640	17,280	2,592	10,800	1,361	10,080	1,210
		13	0.21	14,400	2,160	12,960	1,944	12,240	1,640	17,280	2,592	10,800	1,361	10,080	1,210
		16	0.21	14,400	1,944	12,960	1,750	12,240	1,476	17,280	2,333	10,800	1,225	10,080	1,089
		20	0.12	12,960	1,750	11,664	1,575	11,016	1,328	15,552	2,100	9,720	1,103	9,072	980
		25	0.08	12,960	1,750	11,664	1,575	11,016	1,328	15,552	2,100	9,720	1,103	9,072	980
		30	0.08	12,960	1,750	11,664	1,575	11,016	1,328	15,552	2,100	9,720	1,103	9,072	980
1.75	3.5	15	0.24	12,375	2,115	11,138	1,904	10,519	1,587	14,850	2,538	9,282	1,291	8,663	1,058
		25	0.14	11,138	1,710	10,024	1,539	9,467	1,283	13,365	2,052	8,353	1,043	7,797	855
		35	0.09	11,138	1,710	10,024	1,539	9,467	1,283	13,365	2,052	8,353	1,043	7,797	855
		45	0.072	9,900	1,438	8,910	1,294	8,415	1,079	11,880	1,726	7,425	878	6,930	719
2	4	10	0.4	10,350	2,070	9,315	1,863	8,798	1,584	12,420	2,484	7,763	1,319	7,245	1,159
		13	0.32	10,350	2,070	9,315	1,863	8,798	1,584	12,420	2,484	7,763	1,319	7,245	1,159
		16	0.28	10,350	2,070	9,315	1,863	8,798	1,584	12,420	2,484	7,763	1,319	7,245	1,159
		20	0.28	10,350	2,070	9,315	1,863	8,798	1,584	12,420	2,484	7,763	1,319	7,245	1,159
		25	0.16	9,315	1,677	8,384	1,509	7,918	1,283	11,178	2,012	6,987	1,069	6,521	939
		30	0.16	9,315	1,677	8,384	1,509	7,918	1,283	11,178	2,012	6,987	1,069	6,521	939
		35	0.1	9,315	1,677	8,384	1,509	7,918	1,283	11,178	2,012	6,987	1,069	6,521	939
		40	0.1	9,315	1,677	8,384	1,509	7,918	1,283	11,178	2,012	6,987	1,069	6,521	939
		45	0.08	8,280	1,408	7,452	1,267	7,038	1,076	9,936	1,689	6,210	897	5,796	788
2.5	5	20	0.35	8,100	1,944	7,290	1,750	6,885	1,377	9,720	2,333	6,075	1,215	5,670	1,021
		25	0.35	8,100	1,944	7,290	1,750	6,885	1,377	9,720	2,333	6,075	1,215	5,670	1,021
		30	0.2	7,290	1,750	6,561	1,575	6,197	1,239	8,748	2,100	5,468	1,094	5,103	919
		40	0.2	7,290	1,575	6,561	1,418	6,197	1,115	8,748	1,890	5,468	985	5,103	827

【Note】 Please refer to P636

Recommended Cutting Data (High Precision)

SPM200-BN2/SHM200-BN2

2 Flute, Ballnose

Micro Diameter Endmills for Deep Machining

Workpiece Material				P				N		H					
				Carbon Steel, Alloy Steel (180~250HB)		Alloy Steel, Tool Steel (25~35HRC)		PH,Ferrite, Martensite Steel (35~45HRC)		Copper, Copper Alloys		Hardened Steel (45~55HRC)		Hardened Steel (55~65HRC)	
Ratio to standard depth of cut(ap)				1.00		0.90		0.80		1.20		0.65		0.60	
R (mm)	Mill Dia. (mm)	Under Neck Length (mm)	ap	n r/min	Vf mm/min	n r/min	Vf mm/min	n r/min	Vf mm/min	n r/min	Vf mm/min	n r/min	Vf mm/min	n r/min	Vf mm/min
3	6	12	0.6	8,100	2,268	7,290	2,041	6,885	1,701	9,720	2,722	6,075	1,383	5,670	1,134
		20	0.5	7,650	1,989	6,885	1,790	6,503	1,492	9,180	2,387	5,738	1,213	5,355	995
		30	0.42	7,200	1,728	6,480	1,555	6,120	1,224	8,640	2,074	5,400	1,080	5,040	907
		50	0.15	6,480	1,400	5,832	1,260	5,508	992	7,776	1,679	4,860	875	4,536	734

【Note】

1. For different materials, adjust the cutting depth (ap) according to the cutting depth factors in the above table. E.g. for hardened Steel (45~55HRC), $ap \times 0.5$.
2. When performing cutting where cutting chips may cause clogging, such as for rib cutting, blind grooves, etc., cutting depth setting should be set by multiplying a cutting depth factor to calculate the cutting depth amount, and this amount should then be reduced to 80% of the calculated value.
3. Adjust by setting ae to $(3 \text{ to } 5) \times (ap) \times (\text{cutting depth ratio})$. When performing finishing processing, calculate the theoretical cusp height and set accordingly.
4. Use the appropriate coolant such as air cooling or emulsion for the work material and machining shape.
5. In actual machining, the condition should be adjusted according to the machining shape, purpose and the machine type.
6. If the rpm of the machine is lower than the data in the above table, the feed rate should be lowered in the same ratio.

C

APPENDIX

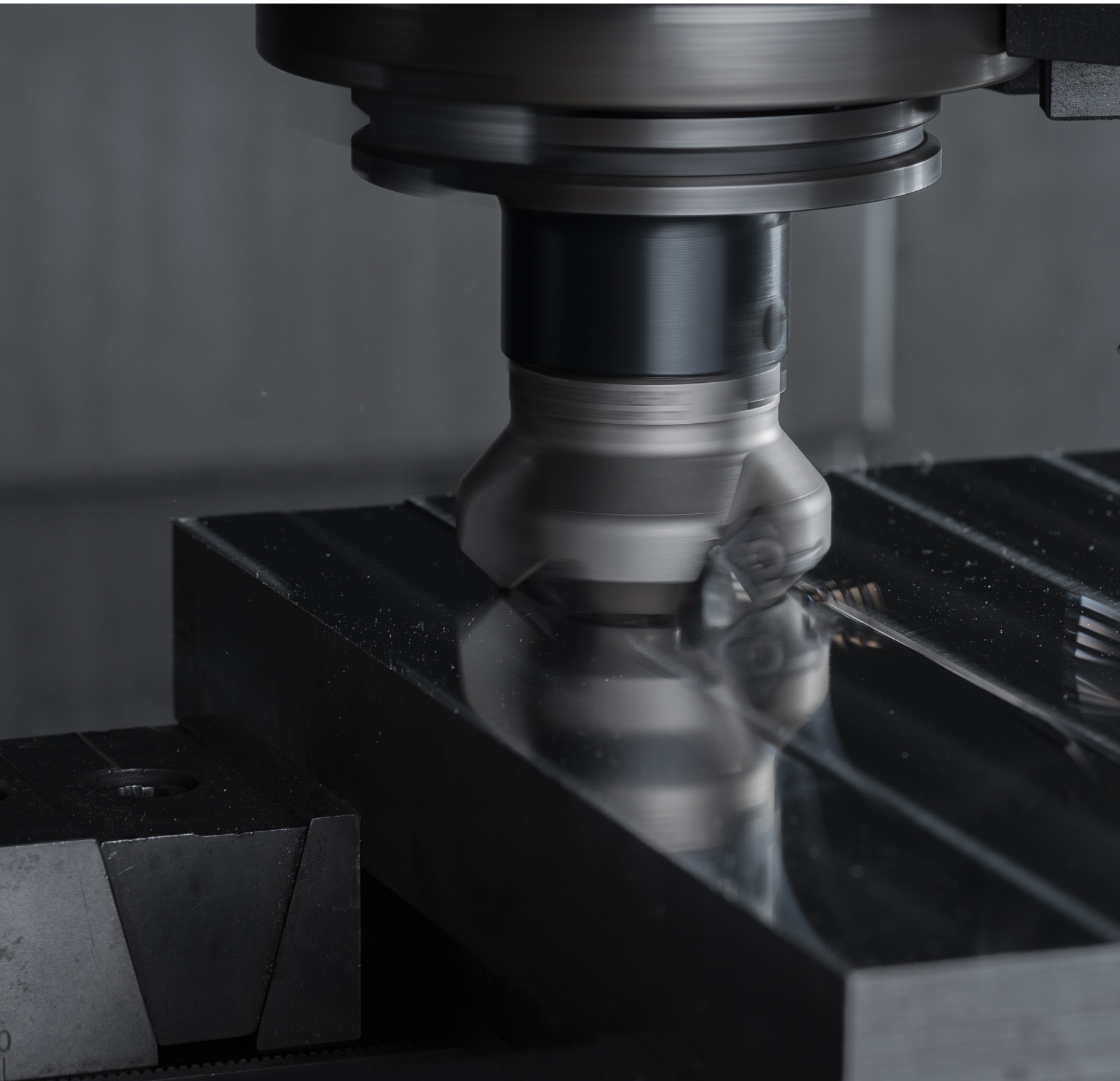

Cutting Calculations and Definitions

Parameter and Unit		
D Diameter	(mm)	F _n Feed per Revolution (mm/rev)
a _p Cutting Depth	(mm)	f _z Feeding per Teeth (mm/tooth)
a _e Cutting Width	(mm)	Z Number of Teeth
V _f Feed Rate	(mm/min)	n Spindle Speed (rev/min)
V _c Cutting Speed	(m/min)	L Length (mm)
Q Rate of Metal Removal	(cm ³ /min)	T _c Processing Time (min)

General Formula	
n Spindle Speed	$n = \frac{V_c \cdot 1000}{\pi \cdot D} \text{ (rev/min)}$
V _c Cutting Speed	$V_c = \frac{\pi \cdot D \cdot n}{1000} \text{ (m/min)}$
V _f Feed Rate	$V_f = f_z \cdot z \cdot n \text{ (mm/min)}$
f _z Feed per Teeth	$f_z = \frac{V_f}{z \cdot n} \text{ (mm)}$
Q Rate of Metal Removal	$Q = \frac{a_e \cdot a_p \cdot V_f}{1000} \text{ (cm}^3\text{/min)}$
T _c Processing Time	$T_c = \frac{L}{V_f} \text{ (min)}$

Workpiece Material Table

ISO Material Group	MC	Workpiece Material	Content	Tensile Strength N/mm ²	Brinell Hardness HB	Rockwell Hardness HRC
P Steel	P1	Low-carbon Steel, Long Chipping	C<0.25%	<530	<125	
	P2	Low-carbon Steel, Short Chipping, Free-cutting Steel	C<0.25%	<530	<125	
	P3	High-carbon Steel, Medium-carbon Steel	C>0.25%	>530	<220	<25
	P4	Alloy Steel, Tool Steel.	C>0.25%	600-850	<330	<35
	P5	Alloy Steel, Tool Steel.	C>0.25%	850-1400	340-450	35-48
	P6	Ferritic Stainless Steel, Martensitic Stainless Steel, PH Stainless Steel	C=(0-0.4)%	600-900	<330	<35
	P7	High-strength Ferritic Stainless Steel, Martensitic Stainless Steel, PH Stainless Steel.	C=(0.1-0.6)%	900-1350	330-450	35-48
M Stainless Steel	M1	Austenitic Stainless Steel	C=(0.05-0.15)%	<600	130-200	
	M2	High-Strength Austenitic Stainless Steel and Cast Stainless Steel	C=(0.05-0.15)%	600-800	150-230	<25
	M3	Duplex Stainless Steel	C=(0.05-0.20)%	<800	135-275	<30
K Cast Iron	K1	Grey Cast Iron		125-500	120-290	< 32
	K2	Moderately Difficult Alloy Cast iron, Nodular Cast Iron.		<600	130-260	< 28
	K3	Difficult High-alloy Cast Iron, Nodular Cast Iron		>600	180-350	< 43
N Non-ferrous Materials	N1	Wrought Aluminium Alloys		<520	60-90	
	N2	Cast Aluminium Alloys	Si<12%	<350	70-100	
	N3	Cast Aluminium Alloys	Si>12%	200-320	60-120	
	N4	Copper, Copper Alloys		200-650	60-200	
	N5	Graphite, CFK, CFRP Graphite, Composite Materials		600-1500		
	N6	GFK, CFK Aluminium-based Composite Materials (MMCs)		<700	<210	
S Heat-resistant SuperAlloys, Titanium Alloys	S1	Iron-based Heat-resistant Alloys		500-1200	160-260	25-48
	S2	Cobalt-based Heat-resistant Alloys		1000-1450	250-450	25-48
	S3	Nickel-based Heat-resistant Alloys		600-1700	160-450	<48
	S4	Titanium and Titanium Alloys		900-1600	300-400	33-48
H Hardened Materials	H1	Hardened Steel				45-55
	H2	Hardened Steel				55-60
	H3	Hardened Steel				60-65
	H4	Hardened Steel				>65

The Structure of Shank-DIN Standard

DIN 6535-HA

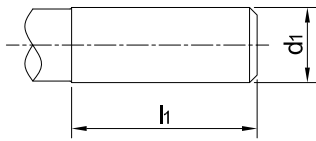

d_1, h_6	2	3	4	5	6	8	10	12	14	16	18	20	25	32
l_1	28				36		40	45	48		50	56	60	

DIN 6535-HB

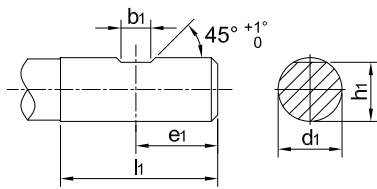

$d_1=6\sim 20\text{mm}$

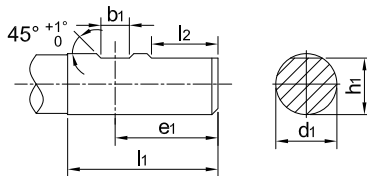

$d_1=25\sim 32\text{mm}$

d_1 h_6	b_1 $+0.05$ 0	e_1 0 -1	h_1 h_{11}	l_1 $+2$ 0	l_2 $+1$ 0	
6	4.2	18	5.1	36	-	
8	5.5		6.9			
10	7	20	8.5	40		
12	8	22.5	10.4	45		
14			12.7			
16	10	24	14.2	48		
18			16.2			
20	11	25	18.2	50		
25	12	32	23	56		17
32	14	36	30	60		19

DIN 6535-HE

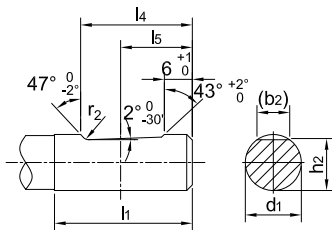

$d_1=6\sim 20\text{mm}$

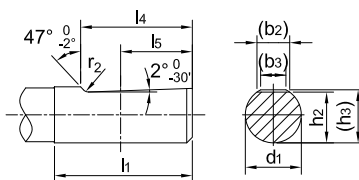

$d_1=25\sim 32\text{mm}$

d_1 h_6	(b_2)	(b_3)	h_2 h_{11}	(h_3)	l_1 $+2$ 0	l_4 0 -1	l_5 Nominal size	r_2 min		
6	4.3	-	5.1	-	36	25	18	1.2		
8	5.5		6.9							
10	7.1		8.5		40	28	20			
12	8.2		10.4		45	33	22.5			
14	8.1		12.7							
16	10.1		14.2		48	36	24	1.6		
18	10.8		16.2							
20	11.4		18.2		50	38	25			
25	13.6		9.3		23	24.1	56		44	32
32	15.5		9.9		30	31.2	60		48	35

Comparison Table for Tensile Strength , Brinell Hardness and Rockwell Hardness

N/mm2	HV10	HB	HRC
240	75	71	
255	80	76	
270	85	81	
285	90	86	
305	95	90	
320	100	95	
335	105	100	
350	110	105	
370	115	109	
385	120	114	
400	125	119	
415	130	124	
430	135	128	
450	140	133	
465	145	138	
480	150	143	
495	155	147	
510	160	152	
530	165	157	
545	170	162	
560	175	166	
575	180	171	
595	185	176	
610	190	181	
625	195	185	
640	200	190	
660	205	195	
675	210	199	
690	215	204	
705	220	209	
720	225	214	
740	230	219	
755	235	223	
770	240	228	
785	245	233	
800	250	238	22
820	255	242	23
835	260	247	24
860	268	255	25
870	272	258	26
900	280	266	27

N/mm2	HV10	HB	HRC
920	287	273	28
940	293	278	29
970	302	287	30
995	310	295	31
1020	317	301	32
1050	327	311	33
1080	336	319	34
1110	345	328	35
1140	355	337	36
1170	364	346	37
1200	373	354	38
1230	382	363	39
1260	392	372	40
1260	403	383	41
1330	413	393	42
1360	423	402	43
1400	434	413	44
1440	446	424	45
1480	458	435	46
1530	473	449	47
1570	484	460	48
1620	497	472	49
1680	514	488	50
1730	527	501	51
1790	544	517	52
1845	560	632	53
1910	578	549	54
1980	596	567	55
2050	615	584	56
2140	639	607	57
	655	622	58
	675		59
	698		60
	720		61
	745		62
	773		63
	800		64
	829		65
	864		66
	900		67
	940		68

Spare Parts Specifications List

Plough Bolt

Form	Ordering Code	Torsion	Dimension							Applicable Tools	
		N·m	A	ΦB	C	D	E	F	α°		
	SI60M020037-02806S	0.6	M2X0.4	2.8	3.7				TT06	60	MPA100-RD05
	SI60M025050-03509S	1.0	M2.5X0.45	3.5	5.0				TT07	60	MPA100-RD07
	SI60M025065-03509S	1.0	M2.5X0.45	3.5	6.4				TT07	60	MEA190-AP11,MEJ190-AP10, MPA100-RD08,MPB100-RP08
	SI60M025065-03610IS	1.2	M2.5X0.45	3.5	6.4				TI07	60	MEE190-WN04,MKA110-UD08
	SI60M030072-04210S	1.8	M3X0.5	4.2	7.2				TT09	60	MEB190/MHB190-AP11
	SI60M030072-04205WW	1.8	M3X0.5	4.2	7.2				TT09	60	MKM113-SD09
	SI60M030090-04205S	1.8	M3X0.5	4.2	9.0				TT09	60	MSA110~113-CN07
	SI60M035080-05314S	3.0	M3.5X0.6	5.3	8.0				TT15	60	MEB190/MHB190-AP16, MPC100-RC12
	SI60M035080-05410B	3.0	M3.5X0.6	5.6	8.6				TT15	60	MFA145-SE13
	SI60M035094-04909IB	3.0	M3.5X0.6	4.8	9.4				TI10	60	MVA*-LN11
	SI60M035100-05018IS	3.0	M3.5X0.6	5.0	10.0				TI15	60	MES190-SD14
	SI60M035116-05410IB	3.0	M3.5X0.6	5.4	12.0				TI15	60	MFA145-SE13(With shim)
	SI60M035120-05314S	3.0	M3.5X0.6	5.3	12.0				TT15	60	MEC190/MHC190-AN12
	SI60M040075-05505WW	3.5	M4X0.7	5.5	7.5				TT15	60	MEH190-XD19
	SI60M040085-05609IB	3.5	M4X0.7	5.6	8.5				TI15	60	MKA110-UD12
	SI60M040089-05313S	3.5	M4X0.7	5.7	9.0				TT15	60	MCA*-SP09,MEA190-AP16, MPA100-RD10/RD12, MPB100-RP10/RP12, MPC100-RC10
	SI60M040094-05311IWW	3.5	M4X0.7	5.3	9.4				TI15	60	MKM113-SD12
	SI60M040100-05510IS	3.5	M4X0.7	5.7	10.0				TI15	60	MEE190-WN08,MKB113-SD12
	SI60M040110-05708IB	4.0	M4X0.7	5.7	11.0				TI15	60	MVA*-LN15
	SI60M040158-07108B	4.0	M4X0.7	7.1	16.0				TT15	60	MFB145-SN12
	SI60M045120-06412S	4.5	M4.5X0.75	6.4	12.0				TT20	60	MEC190/MHC190-AN16
	SI60M050108-07209S	5.0	M5X0.8	7.2	10.8				TT20	60	MCA*-SP12,MFA143-OD06, MPA100-RD16,MPB100-RP16, MPC100-RC16
	SI60M050108-07214IB	5.0	M5X0.8	7.2	10.9				TI20	60	MKA110-UP17,MKB113-SD15
	SI83M050140-07010IB	5.0	M5X0.8	7.0	14				TI20	83	MFB245/MFB275/MFB288-SN12
	SI60M060160-08509S	7.5	M6X1	8.4	15.8				TT25	60	MPC100-RC20
	SI90M040032-06003IFQ	1.7	M4X0.5	6.0	3.2				TI08	90	MSA104-SN12
	SI90M040042-06003IFQ	1.7	M4X0.5	6.0	4.2				TI08	90	MSA105-SN12
	SI90M040051-06003IFQ	1.7	M4X0.5	6.0	5.1				TI08	90	MSA106-SN12
	SI90M040061-06003IFQ	1.7	M4X0.5	6.0	6.1				TI08	90	MSA107-SN12
	SI90M040071-06003IFQ	1.7	M4X0.5	6.0	7.1				TI08	90	MSA108-SN12
	SR30M040100K	3.5	M4X0.7	5.7	10.0				TT15		MFC*-HN06/HN09
	SR45M060160IK	8.0	M6X1	9.5	16.0				TI25		MFC145-HN13

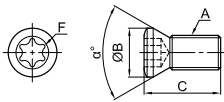

Spare Parts Specifications List

Plough Bolt

Form	Ordering Code	Torsion	Dimension							Applicable Tools
		N·m	A	ΦB	C	D	E	F	α°	
	SBM035095Q	2.0	M3.5X0.6	4.8	9.7			TT10	40	MBA100-QT12
	SBM040135Q	3.0	M4X0.7	5.8	13.3			TT15	40	MBA100-QT16
	SBM050165Q	4.0	M5X0.8	6.8	16.6			TT20	40	MBA100-QT20
	SBM060200Q	5.0	M6X1	8.3	20.6			TT20	40	MBA100-QT25
	SBM080250Q	6.0	M8X1.25	11.1	25.0			TT30	40	MBA100-QT30

Platen Screw

Form	Ordering Code	Torsion	Dimension							Applicable Tools
		N·m	A	ΦB	C	D	E	F	α°	
	SI60M035100-05510S	-	M3.5X0.6	5.0	10.0			TT15	50	MPA100-RD10,MPB100-RP10
	SI60M035120-05314S	-	M3.5X0.6	5.3	12.0			TT15	60	MPA100-RD12,MPB100-RP12

Dowel Screw

Form	Ordering Code	Torsion	Dimension						Applicable Tools	
		N·m	A	ΦB	C	D	E	F		
	SDAM060200B	-	M6X1			20.5	8.3	8.3	3.0	MFB160/MFB260-HN09
	SDAM080245B	-	M8X1.25			24.5	8.7	12.2	4.0	MFB160-HN09

刀垫螺钉

Form	Ordering Code	Torsion	Dimension						Applicable Tools
		N·m	A	ΦB	C	D	E	F	
	SSAM050070B	-	M5X0.5	6.3	7	3		3.5	MFA145-SE13
	SSAM060075B	-	M6X0.75	7.8	7.5	3.6		4	MFB145-SN12

Spare Parts Specifications List

Wrench

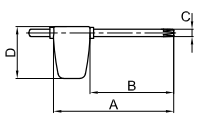
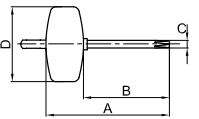
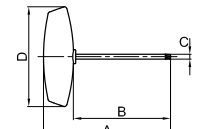
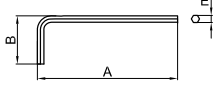
Form	Ordering Code	Dimension						Applicable Tools
		A	B	C	D	E	F	
	TT06PQ	51	35	TT06	15			MPA100-RD05
	TI07PB	54	35	TI07	19			MEE190-WN04,MKA110-UD08
	TT07PQ	54	35	TT07	19			MEA190-AP11,MEJ190-AP10,MPA100-RD07,MPA100-RD08,MPB100-RP08
	TI08PQ	60	40	TI08	19			MSA104~108-SN12
	TT09PQ	60	40	TT09	24			MEB190/MHB190-AP11,MSA110~113-CN07,MKM113-SD09
	TI10PB	60	40	TI10	24			MVA*-LN11
	TI15PB	66	45	TI15	28			MEE190-WN08,MES190-SD14,MFA145-SE13,MKA110-UD12,MKB113-SD12,MVA*-LN15
	TT15PB	66	45	TT15	28			MEH190-XD19,MFA145-SE13,MFB145-SN12
	TT15PQ	66	45	TT15	28			MCA*-SP09,MEA190-AP16,MEB190/MHB190-AP16,MEC190/MHC190-AN12,MFC*-HN06/HN09,MPA100-RD10/RD12,MPB100-RP10/RP12,MPC100-RC10/RC12
	TI20PB	66	45	TI20	28			MFB245/MFB275/288-SN12,MKA110-UP17,MKB113-SD15
	TT20PQ	66	45	TT20	28			MCA*-SP12,MEC190/MHC190-AN16,MPA100-RD16,MPB100-RP16,MPC100-RC16
		TT10KQ	60	40	TT10	40		
TT15KQ		66	45	TT15	40			MBA100-QT16
TT20KQ		66	45	TT20	40			MBA100-QT20,MBA100-QT25
	TT09TQ	126	100	TT09	80			MEB190-AP11
	TI10TB	126	100	TI10	80			MVA*-LN11
	TI15TB	126	100	TI15	80			MEE190-WN08,MES190-SD14,MFA145-SE13,MKB113-SD12,MVA*-LN15,MKM113-SD12
	TT15TB	126	100	TT15	80			MEH190-XD19,MFB145-SN12
	TT15TQ	126	100	TT15	80			MEA190-AP16,MEB190-AP16,MFC*-HN06/HN09
	TI20TB	132	100	TI20	100			MFB245/MFB275/288-SN12,MKA110-UP17,MKB113-SD15
	TT20TQ	132	100	TT20	100			MEC190-AN16,MFA143-OD06,MPA100-RD16,MPB100-RP16,MPC100-RC16
	TI25TQ	182	150	TI25	100			MFC145-HN13
	TT25TQ	132	100	TT25	100			MPC100-RC20
	TT30TQ	132	100	TT30	100			MBA100-QT30
	TH30LB	64	22			3		MFB160/MFB260-HN09
	TH35LB	67	25			3.5		MFA145-SE13
	TH40LB	71	28			4		MFB145-SN12,MFB160-HN09

Note: For Tool-holder diameters > 80 mm, use a T-wrench (except for MFB160/260 series)

Spare Parts Specifications List

Wedge

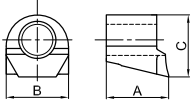
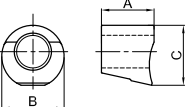
Form	Ordering Code	Dimension						Applicable Tools
		A	B	C	D	E	F	
	CWA01B	10	10	10				MFB160/MFB260-HN09
	CWA02B	11	13	12.5				MFB160-HN09

Adjustable Clamps

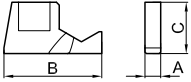
Form	Ordering Code	Dimension						Applicable Tools
		A	B	C	D	E	F	
	AMFB1601RAB	5.5	34.3	18				MFB160-HN09

Shim

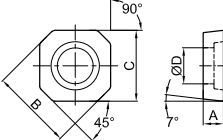
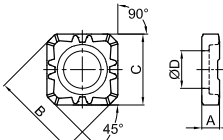
Form	Ordering Code	Dimension						Applicable Tools
		A	B	C	ΦD	E	F	
	H0K30DSE1300S	3	12.1	10.5	5.4			MFA145-SE13
	H0K30SSN12	3.15	15.6	12.6	6.7			MFB145-SN12

Plate

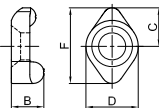
Form	Ordering Code	Dimension						Applicable Tools
		A	B	C	D	E	F	
	PCAX01RQ		5	5.2	7.6		10.2	MPA100-RD10,MPB100-RP10
	PCAX02RQ		5.9	5.9	9		12.3	MPA100-RD12,MPB100-RP12



XIAMEN GOLDEN EGRET SPECIAL ALLOY CO.,LTD.

Add: No.69 Xinglong Road Huli District Xiamen CHINA
Factory Add: No.1601-1629 Jicheng Road Industrial
Concentration Area Tongan Xiamen CHINA
Tel: +86-592-7107392
Fax: +86-0592-7107322
P C : 361006
Email: GJ.GLB@CXTC.COM

www.gesac.net

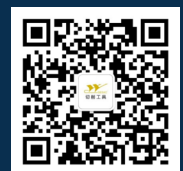

GE202306be
