

GENERAL CATALOG - VOL. 4

TOOLING SYSTEM

we improve, we evolve, we **ADD**

2023/2024





Tungaloy's Insights – Smart Manufacturing

Tungaloy, as one of the leaders in the metal removal industry, offers the latest innovations in grades and geometries for superb performance and tool life.

*Tungaloy's latest
innovations in cutting
tools contribute to
carbon neutrality*



VOL. 4

TOOLING SYSTEM

A	Grade	A001 -
B	Insert	B001 -
C	External Toolholder	C001 -
D	Internal Toolholder	D001 -
E	Threading Tool	E001 -
F	Parting, Grooving	F001 -
G	Miniature Machining	G001 -
H	Milling Cutter	H001 -
I	Endmill	I001 -
J	Drilling Tool	J001 -
K	Tooling System	K001 -
L	User's Guide	L001 -
M	Alphanumeric Index	M001 -

About Tungaloy Cutting Tool Catalog

Note in using this catalog:

- ★ This catalog provides the information of Tungaloy's cutting tools as of March 2023.
- ★ The specifications are subject to change without prior notice for product improvements. Also, the products may be discontinued in the future due to the development of new products.
- ★ The dimensions of all products are shown in millimeters (mm).
- ★ For indexable tools, such as toolholders, cutters, drill bodies, applicable inserts or heads need to be ordered separately.

How to use this catalog:

The image shows a navigation menu on the left with categories like Grade, Insert, External Toolholder, Internal Toolholder, Threading Tool, Parting, Grooving, Miniature Machining, Milling Cutter, Endmill, Drilling Tool, Tooling System, and User's Guide. The 'Alphanumeric Index' is highlighted with a red box and the number 2. The main content area shows two pages of tool specifications for C-ACLNRL and C-ACLNRP tool types. Each page includes diagrams of the tool, a table of designations with dimensions (DOCNMS, LF, L2, WF, DMEN, DMEN2, RE, Insert), and a list of spare parts. Red boxes and numbers 1 and 2 indicate the selection of tool type and the use of the alphanumeric index.

- 1 Select the tool type at the application index on the left pages.
- 2 The index is in the alphanumeric order. Use it for your product search.

How to read the list for the standard items:

- ★ Designations for tooling products - TungCap toolholders, colletchuck holders, etc.
 - Orders are to be received for the tools with the designations in the catalog.
 - For the tool with right- and left-hand options, the designation includes ****R/L**** as shown below.
 - Ex. 1: Designation: C4PDUN**R**/L17080-11
You can order both right- and left-hand tools. C4PDUN**R**17080-11 (a right-hand tool) and C4PDUN**L**17080-11 (a left-hand tool) will be available.
 - Ex. 2: Designation: C3SDX**R**R13080-07
You can order only right-hand tools. Please contact us when you need left-hand tools.

About Tungaloy Cutting Tool Catalog

■ Icons at the left side of each page

External toolholder (cutting edge shape / angle)

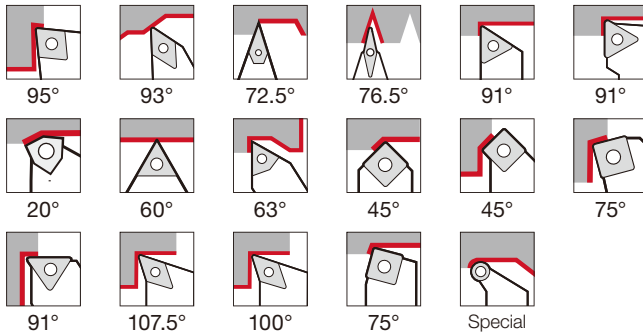

Internal toolholder (cutting edge shape / angle)

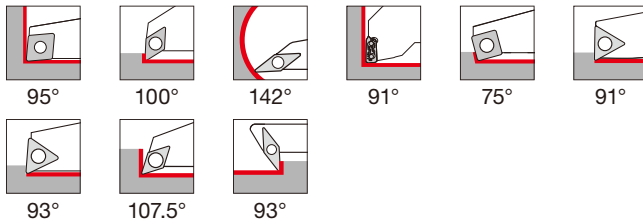

Parting, Grooving

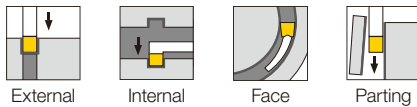

Miniature machining



Mill

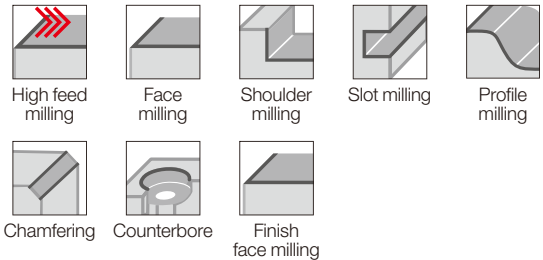

Endmill

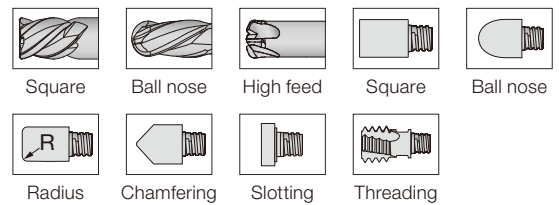

Drill

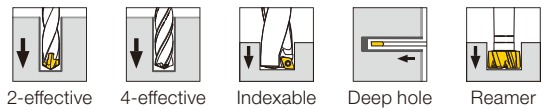

■ Icons for applications of each product

Threading

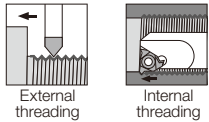

Grooving

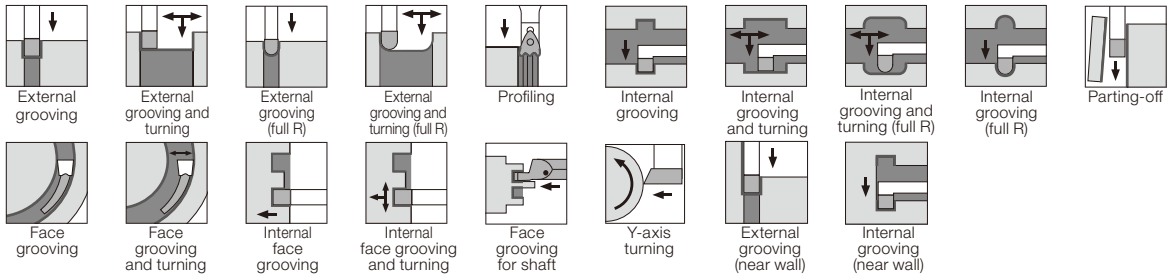

Milling

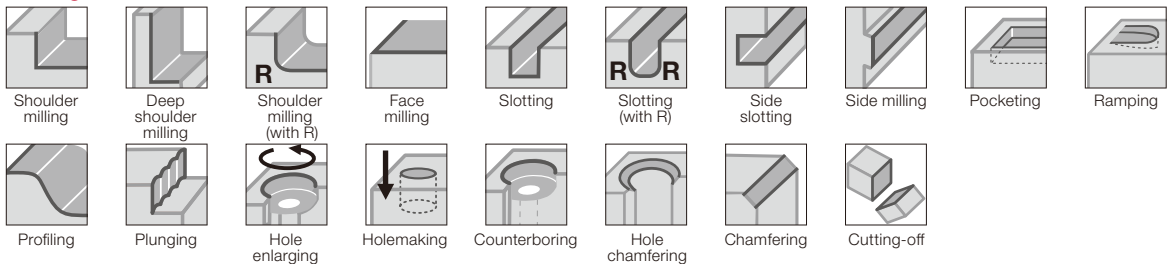

Drilling



About the dimension symbols conforming to ISO13399

■ What is ISO13399?

ISO13399 is an international standard for the purpose of standardizing the electronic data of tools in the world.

■ Switching to the dimension symbols conforming to ISO13399

In this catalog, we use the dimension symbols (properties) conforming to ISO13399 international standard.

Below are the examples of the change.

■ Examples of the change:

	Before	After
Insert		
Turning		
Milling		
Drilling		

ISO13399 standardizes not only the format of 2D and 3D CAD data but also the tool dimension symbols (properties) and reference position information. This allows the tool information to be read and combined into NC programs and CAM software, regardless of any tool maker's data. In addition to General Catalog (paper catalog), we are also updating the symbols in e-catalog (electronic catalog on our website) to the properties conforming to ISO13399. The e-catalog also provides 2D and 3D CAD data in accordance with ISO13399 standard.

■ Insert

New symbol	Old symbol	Description
AN	-	Main cutting edge relief angle
APMX	Max. ap	Maximum depth of cut
AS	A	Side cutting edge relief angle
BW	B	Body width
BS	bs	Side cutting edge (wiper) length
CDX	T max	Maximum groove depth
CW	W	Grooving edge width
D1	ød1	Mounting hole diameter
DCONMS	øDs	Mounting part diameter on the machine
DMIN	øDm	Minimum machining diameter
EPSR	-	Nose angle
GAN	-	Rake angle (insert)
IC	ød	Inscribed circle diameter
INSD	A	Insert diameter (round type)
INSL	B	Insert length
KAPR	κ	Approach angle
LBB	-	Chipbreaker width
LE	A	Effective cutting edge length
LF	L1	Standard length
M	m	Distance from inscribed circle to cutting edge (m dimension)
PDX	t	Thread position (X direction)
PDY	ℓ3	Thread position (Y direction)
PNA	θ	Cutting edge angle
PSIRL	θ	Left-hand front cutting edge angle
PSIRR	θ	Right-hand front cutting edge angle
RE	r	Corner radius
S	T	Thickness
W1	-	Insert width

■ Turning, Grooving

New symbol	Old symbol	Description
B	b	Shank width
BD	øD1, øD2, øD3	Body external diameter
CDX	ar	Maximum groove depth
CND	-	Oil hole diameter
CNT	-	Oil hole plug size
CUTDIA	øDmax	Maximum parting diameter
CW	W	Grooving edge width
CWN	-	Minimum grooving edge width
CWX	-	Maximum grooving edge width
DAXN	øDm	Minimum diameter in face grooving
DAXX	øDmax	Maximum diameter in face grooving
DCONMS	øDs	Mounting part diameter on the machine
DCONWS	øD, ød2	Mounting part diameter on the workpiece
DMIN	øDm	Minimum machining diameter
GAMF	α	Radial rake angle
GAMP	θ	Axial rake angle
H	h	Shank length
HBH	h2	Height of offset on the bottom of head
HBKL	f2	Length of uneven level on the back of head
HBKW	L2	Width of uneven level on the back of head
HBL	L2	Length of offset on the bottom of head
HF	h1	Standard height
KAPR	κ	Approach angle
LB	L	Body length
LF	L1	Standard length
LH	L2	Head length
OAH	h4	Overall height
OAL	L1	Overall length
OAW	L3	Overall width
PSIR	β	Lead angle
WB	-	Body width
WF	f	Standard width
WFS	f2	Standard width (the second corner)

About the dimension symbols conforming to ISO13399

■ Tooling system

New symbol	Old symbol	Description
APMX	Max. ap	Maximum depth of cut
BD	$\varnothing D1, \varnothing D2, \varnothing D3$	Body external diameter
BHTA	α	Neck taper angle (half of nose angle)
BTED	$\varnothing d1$	Taper tip diameter
CRKS	S	Mounting screw size
DBC	$\varnothing d3$	Bolt hole pitch diameter
DCONMS	$\varnothing Ds$	Mounting part diameter on the machine
DCONWS	$\varnothing D, \varnothing d2$	Mounting part diameter on the workpiece
DMIN	$\varnothing Dm$	Minimum machining diameter
GAMF	$\alpha, R.R.$	Radial rake angle
GAMP	$\theta, A.R.$	Axial rake angle
KAPR	κ	Cutting edge angle
LB	L2, L3	Body length
LF	L	Standard length
LPR	L1	Parting length
LS	ℓs	Shank length
LSC	Lmin	Clamp length
LSCX	Lmax	Maximum clamp length
OAH	H4	Overall height
OAL	L	Overall length
OAW	W	Overall width
THID	-	Mounting screw size
WB	W	Body width
WF	f	Standard width

■ Drilling

New symbol	Old symbol	Description
BD	$\varnothing D1, \varnothing D2, \varnothing D3$	Body external diameter
CND	-	Oil hole diameter
CNT	-	Oil hole plug size
CRKS	S	Mounting screw size
DC	$\varnothing Dc$	Machining diameter
DCONMS	$\varnothing Ds$	Mounting part diameter on the machine
DCONWS	$\varnothing D, \varnothing d2$	Mounting part diameter on the workpiece
DCSFMS	$\varnothing D$	Connecting part diameter
KAPR	κ	Cutting edge angle
LCF	ℓ	Flute length
LF	Lf	Standard length (from the drill shoulder)
LPR	-	Parting length (from flange to tip)
LS	ℓs	Shank length
LU	ℓ	Machinable depth
NOF	z	Number of flutes
OAL	L	Overall length (from tip)
PL	PL	Distance from drill tip to shoulder
ZEFP	Z eff	Number of effective cutting edges on periphery

■ Milling

New symbol	Old symbol	Description
APMX	Max. ap	Maximum depth of cut
BD	$\varnothing D1, \varnothing D2, \varnothing D3$	Body external diameter
BHTA	α	Neck taper angle (half of nose angle)
CBDP	ℓ	Mounting hole depth
CDX	Max. ae	Maximum slot width
CHW	k	Chamfer width on the corner
CICT	z	Number of inserts
CRKS	S	Mounting screw size
CW	W	Slotting edge width
CWN	-	Minimum slotting edge width
CWX	-	Maximum slotting edge width
DBC	$\varnothing d3$	Bolt hole pitch diameter
DC	$\varnothing Dc$	Machining diameter
DCONMS	$\varnothing d$	Mounting part diameter on the machine
DCONWS	$\varnothing D, \varnothing d2$	Mounting part diameter on the workpiece
DCSFMS	$\varnothing Db$	Mounting surface diameter on the machine
DCX	$\varnothing Dc1$	Maximum machining diameter
GAMF	R.R.	Radial rake angle
GAMP	A.R.	Axial rake angle
H	T	Width across flat
KAPR	κ	Cutting edge angle
KWW	a	Drive key width
LF	Lf	Standard length
LH	Lf	Neck length
LS	ℓs	Shank length
NOF	z	Number of flutes
OAL	L, L6	Overall length
PDX	t	Thread position (X direction)
PNA	θ	Cutting edge angle
PSIR	β	Lead angle
RMPX	θ	Maximum ramping angle
THUB	T	Hub height (slot mill)
WT	Kg	Weight
ZEFP	Z eff	Number of effective cutting edges on the periphery

Note:

- Symbols unspecified in ISO13399 standard and Tungaloy's original symbols are not included.
- The symbols still under discussion are included. Please note any change or addition may occur.

■ CAD data provided in e-catalog

● 2D data (DXF format file)

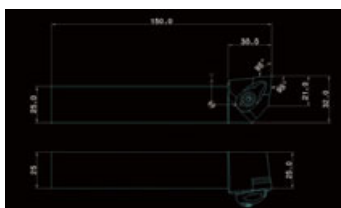

Turning:
Shows the insert with standard corner radius.

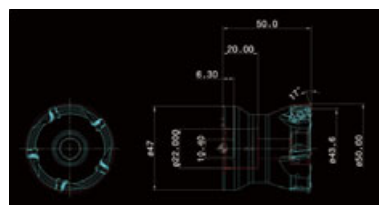

Milling:
Includes actual cutting edge curve (CUT layer) and body cross section (NOCUT layer).

● 3D data Light type (STP format file): Can be used to check tool path and interference.

Turning: Equipped with an insert with a standard corner radius.

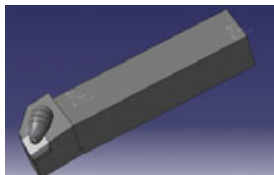

Milling: A rotating body model of an actual cutting edge curve and a body cross section.



● 3D data Detail type (STP format file): Can be used to create a new tool layout chart. (Can be combined with any insert model on a CAD software.)

Turning

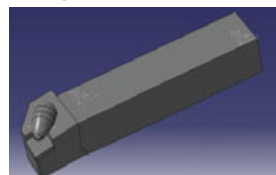

Milling



Tooling System



Tooling System - Content structure

Products are listed by series.

Please refer the table of contents.

Tooling items in the catalog are our standard items.

How to use the page

Method 1.

Select the series name (1) described at the left end of each page and choose a designation you need (4) in the dimension table (3).

Method 2.

Select the series name on **K003** and check the details on the product page.

1 Name of the series
2 Series name and item
3 Dimension
4 Designation
5 Dimension drawing (conforming to ISO 13399)
6 Spare parts
7 Cutting edge shape
8 Holder type
9 Reference pages

1 Name of the series
2 Series name and item
3 Dimension
4 Designation
5 Dimension drawing (conforming to ISO 13399)
6 Spare parts
7 Cutting edge shape
8 Holder type
9 Reference pages

1 Name of the series
2 Series name and item
3 Dimension
4 Designation
5 Dimension drawing (conforming to ISO 13399)
6 Spare parts
7 Cutting edge shape
8 Holder type
9 Reference pages

When ordering

- Please specify the designation and quantity for PINZBOHR® boring system.

e.g. Head: **AC5ACLN00090-12** ... 1 (one head per package)

Arbor: **BT34032100** ... 1 (one arbor per package)

*The designation in the catalog may be described with spaces. Please remove such spaces.

*Inserts are sold separately.

- PINZBOHR® Boring System is a product of MYFHE, S. A., in Spain.

Please see the MYFHE website: <http://www.pinzbohr.com/ingles.htm>

Tooling System



TUNGCAP

Quick change system with polygon PSC coupling tooling

K004 -



TUNGHOLD

Tooling system for holders with unique functions in wide varieties

DIN69871 K060 - HSK A/E K073 -
BT MAS K088 - DIN2080 K108 -

K060 -



SPINJET

Coolant-driven high speed compact spindle

K156 -



SWISSBORE

Fine boring head system
High accuracy diameter adjustment mechanism with no backlash
Easy-to-read digital display window

K164 -

Other tooling system

FixedTorqueWrench K162 - PINZBOHR® K178 -
Cartridge K180 - Boring bar tool K199 -
Top borer tool K202 -

K178 -

Tool management system



MATRIX

Total management of tools simplifies inventory control

K204 -



Productivity increases when used on CNC turret lathes / turning centers

Reduce downtime in your machine

- Short setup time - no tool adjustment required on the machine
- Once adjusted outside the machine, high precision

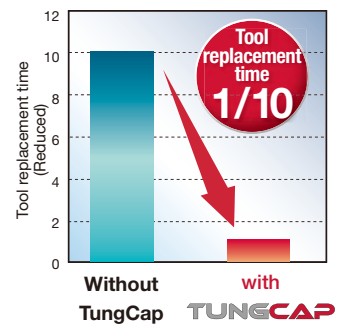

Measurement outside the machine



Input measured data



Short tool change time



High precision in simple process

Breakdown for total operation time

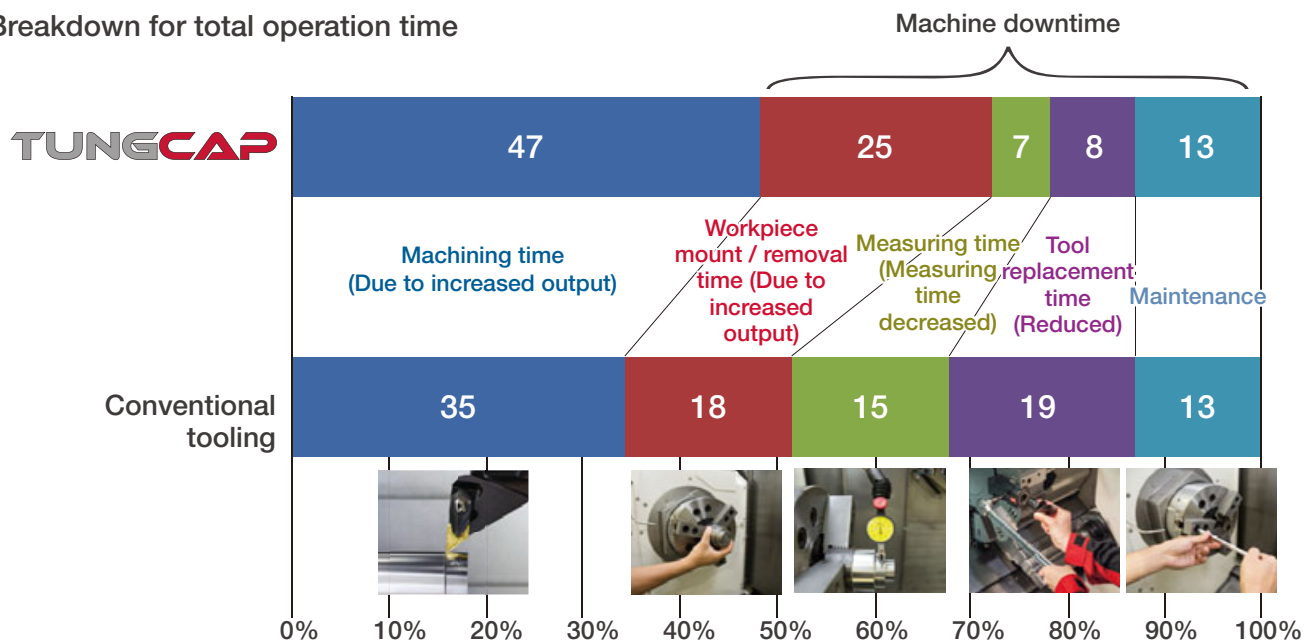

Toolings for multi-tasking machine

A multi-tasking machine is a combination of a turning center and a machining center, which allows a workpiece to be completed in a single machine setup.

TungCap offers a complete range of efficient tooling solutions in such a highly advanced machine-tool.

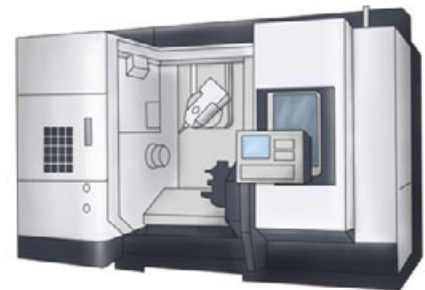

Easy tool management

Suitable for a wide range of applications

- TungCap modular system enhances tooling flexibility in a wide range of applications, without compromising other interface adapters
- Adaptors for HSK and dual-contact BT taper are also available

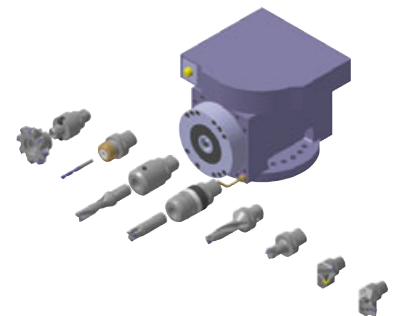

Ideal tooling

An optimized overhang length can be set with an extension or reduction holder































Cutting heads for a B-axis locked at 45° in multi-tasking machines

- A large radial stroke is possible for B-axis
- Heavy-duty machining is possible due to diverse cutting force
- No interference in machining corner radii



Turning tools

 CN**1204 CN**0904	 C*PCLNR/L****-CHP K009	 C*PCLNR/L****-12N K008	 C*ACLR/L****-N K008	 C6PCMNN**-CHP K018	 C*ACLRN00****-N K009	Cutting head for external turning & facing
 TN**1604 TN**1104	 C*A/PTJNR/L****-N K013	 C*ACMNN00****-N K018	 WN**0804 WN**0604	 C*PWLNR/L****-CHP K010	 C*AWLNR/L****-N K010	
 DN**1504 (DN**1506)	 C*PDJNR/L****-CHP K012	 C*PDJNR/L****-15N K012	 C*ADJNR/L****-N K011	 C6PDMNL**-CHP K019	 C*ADNN00****-15N K016	
 VN**1604	 C*PVJNR/L****-16-CHP K014	 C*AVJNR/L****-16N K014	 VC**1604**	 C*SVJCR/L****-16N K015	 C*SVVCN00****-16N K016	
 DN**1104	 C4PDUNR/L****-11 K024	 DN**1504	 C*ADUNR/L****-15 K024	 CN**1204 CN**0904	 C4PCLNR/L****-N K023	
 WXGU0403**L	 C*SWLXR**-04 K024	 DXGU0703**L	 C*SDXXR**-07 K025	 VB**1103 VB**1604	 C*SVQBR**-11/16 K026	
Boring bar		Sleeve SC****		Boring bar Adaptor C*ABB**-*** K026 C*ADI** K028		
DRILLMEISTER TUNGDRILL TUNGSIX-DRILL		Side-lock holder (For weldon-shank) C*EM**X** K038 Side-lock holder (For whistle-notch shank) C*EM**X**E K039		TungDrillTwisted C*TDX**L***-3 K036		
 DGS, SGS, DGM, SGM, DTX, DTE, DGG, DTR, SGN	 16ER/L***		 C*CER/L****-16ERN K029			Cutting head for threading
Blade	Adaptor for parting-off blade  K036	 C*CHSR/L****N K032	 C*CHFVR/L****N K032	 C*CHSN**-CHP K034	 C*CHFVN**-CHP K034	Cutting head for grooving
Toolholder for external turning	 C*ADES-20 K022	 C*ASHR/L*** K021	 C*ASHR/L**-45 K022	 C*ASHA** K021	 C*ADE-**R/L K021	Adaptor for toolholder with square shank
 C*ASHA-HPMC K021	 C*ASHR/L-HPMC K022	 C*ASHR/L-45-HPMC K022				

Please see page K*** for the product details.

System for Multi-Tasking Machine

Grade
Insert
Ext. Toolholder
Int. Toolholder
Threading
Grooving
Miniature tool
Milling cutter
Endmill
Drilling tool
Tooling System
User's Guide
Index

A
B
C
D
E
F
G
H
I
J
K
L
M

TOOLING SYSTEM



Tool spindle



Rotating tools

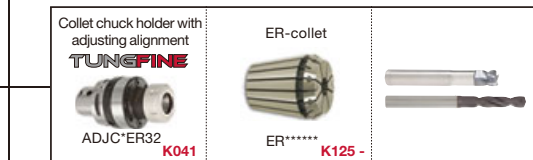
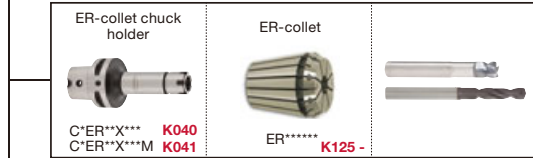

Multi clamp
MULTICLAMPC*
K050



Clamping unit
K055
For machines
K056

Please see page K*** for the product details.

Double-clamp toolholder, with 95° approach angle, for negative 80° rhombic inserts

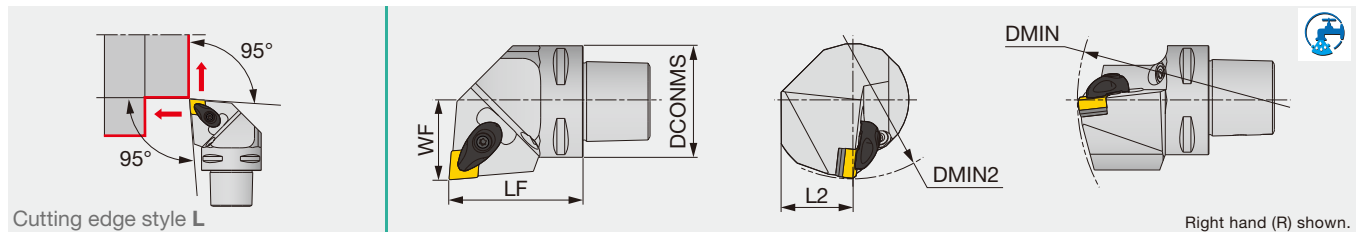

Designation	DCONMS	LF	L2	WF	DMIN	DMIN2	RE	Insert
C3ACLNR/L22040-0904N	32	40	20	22	110	121	0.8	CN**0904**E
C3ACLNR/L22040-12N	32	40	20	22	121	116	0.8	CN**1204...
C4ACLNR/L27050-0904N	40	50	25	27	140	110	0.8	CN**0904**E
C4ACLNR/L27050-12N	40	50	25	27	140	110	0.8	CN**1204...
C5ACLNR/L35060-12N	50	60	32	35	165	110	0.8	CN**1204...
C6ACLNR/L45065-0904N	63	65	35	45	190	110	0.8	CN**0904**E
C6ACLNR/L45065-12N	63	65	41	45	190	125	0.8	CN**1204...
C6ACLNR/L45065-16N	63	65	41	45	190	125	1.2	CN**1606...
C6ACLNR/L45135-12N	63	135	41	45	190	110	0.8	CN**1204...

Applicable for 7 MPa coolant

Designation	Clamp	Clamping screw	Coolant parts	Shim	Shim screw	Spring	Spring pin	Wrench 1	Wrench 2
C*ACLN***-0904N	ACP3S-E	ACS-5W	SATZ-M10X1-5	ASC322	CSTB-3.5	BP-7	SP-2.5	-	T-15F
C*ACLN***-12N	ACP4S	ACS-5W	SATZ-M8X1-M3	ASC422	CSTB-3.5	BP-7	SP-2.5	-	T-15F
C6ACLN*45065-16N	ACP5S	ACS-6W	SATZ-M8X1-M3	ASC533	CSTB-5	BP-8.8	SP-2.5	KEYV-T20	-

C-PCLNR/L

Lever-lock toolholder, with 95° approach angle, for negative 80° rhombic inserts

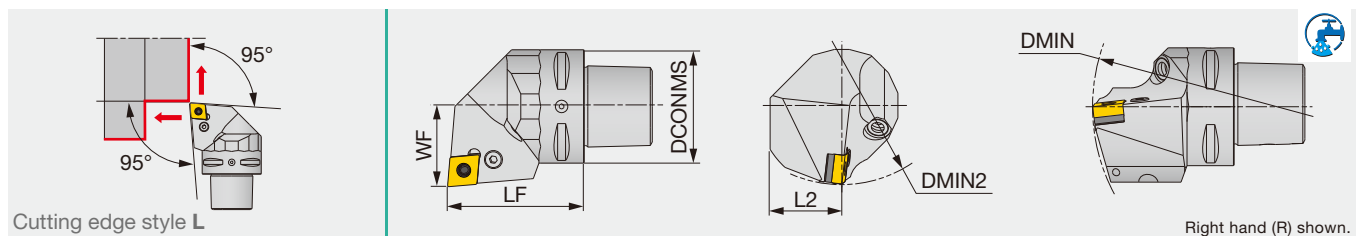

Designation	DCONMS	LF	L2	WF	DMIN	DMIN2	RE	Insert
C5PCLNR/L35060-12	50	60	32	35	-	-	0.8	CN**1204...
C5PCLNR/L35060-12N	50	60	32	35	165	110	0.8	CN**1204...
C6PCLNR/L45065-12N	63	65	41	45	190	125	0.8	CN**1204...

Applicable for 7 MPa coolant

The item without DMIN and DMIN2 cannot be used for boring.

Designation	Coolant parts	Lever	Clamping screw	Shim	Spring pin	Wrench
C5PCLN*35060-12	EZ104	LCL4	LCS4	LSC42	LSP4	P-3
C*PCLN***-12N	SATZ-M10X1-M5	LCL4	LCS4	LSC42	LSP4	P-3

Reference pages: C-ACLNR/L, C-PCLNR/L: Inserts → **B054 -**, CBN → **B168 -**, PCD → **B211 -**

C-PCLNR/L-CHP

Lever-lock toolholder, with 95° approach angle, for negative 80° rhombic inserts, with high pressure coolant capability

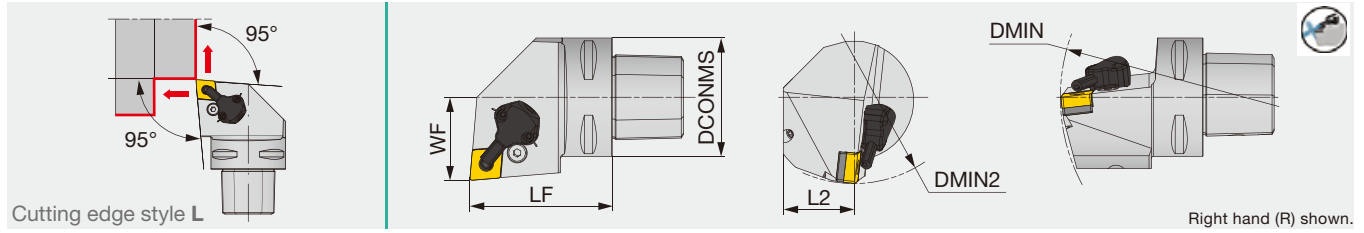

Designation	DCONMS	LF	L2	WF	DMIN	DMIN2	RE	Insert
C4PCLNR/L27050-0904-CHP	40	50	25	27	140	110	0.8	CN**0904...
C4PCLNR/L27050-12-CHP	40	50	25	27	140	110	0.8	CN**1204...
C5PCLNR/L35060-12-CHP	50	60	32	35	165	110	0.8	CN**1204...
C6PCLNR/L45065-0904-CHP	63	65	41	45	195	125	0.8	CN**0904...
C6PCLNR/L45065-12-CHP	63	65	41	45	195	125	0.8	CN**1204...

Applicable for 14 MPa coolant

SPARE PARTS						COOLANT SET				
Designation	Shim	Clamping screw	Spring pin	Lever	Wrench	Designation	Coolant unit	Mounting screw	Wrench	O-ring
C*PCLNR/L**-12-CHP	LSC42	LCS4	LSP4	LCL4	P-3	C*PCLNR/L**-CHP	CU-CW-CHP	SRM3	T-8F	OR6.4X0.9N
C*PCLNR/L**0904-CHP	LSC317	LCS3	LSP3	LCL33	P-2.5					

C-ACLNN

Double-clamp toolholder, with 95° approach angle, for negative 80° rhombic inserts

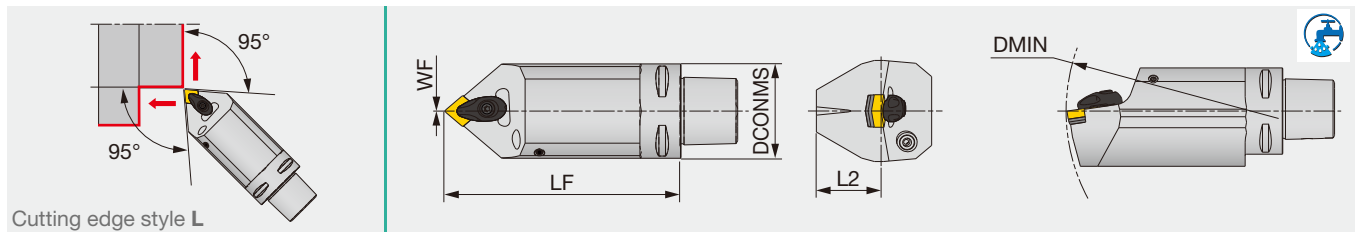

Designation	DCONMS	LF	L2	WF	DMIN	RE	Insert
C5ACLNN00090-12 ⁽¹⁾	50	90	32	0	-	0.8	CN**1204...
C5ACLNN00090-12N ⁽²⁾	50	90	32	0	165	0.8	CN**1204...
C5ACLNN00125-12 ⁽¹⁾	50	125	32	0	-	0.8	CN**1204...
C5ACLNN00125-12N ⁽²⁾	50	125	32	0	165	0.8	CN**1204...
C6ACLNN00100-12N ⁽²⁾	63	100	37.5	0	190	0.8	CN**1204...
C6ACLNN00140-12N ⁽²⁾	63	140	37.5	0	190	0.8	CN**1204...

The items without DMIN cannot be used for boring.
 (1) Applicable for 3 MPa coolant (2) Applicable for 7 MPa coolant

SPARE PARTS								
Designation	Clamp	Clamping screw	Coolant parts	Shim	Shim screw	Spring	Spring pin	Wrench
C5ACLNN00090-12	ACP4S	ACS-5W	EZ83	ASC422	CSTB-3.5	BP-7	SP-2.5	T-15F
C5ACLNN00090-12N	ACP4S	ACS-5W	SATZ-M8X1-M3	ASC422	CSTB-3.5	BP-7	SP-2.5	T-15F
C5ACLNN00125-12	ACP4S	ACS-5W	EZ83	ASC422	CSTB-3.5	BP-7	SP-2.5	T-15F
C*ACLNN001**-12N	ACP4S	ACS-5W	SATZ-M8X1-M3	ASC422	CSTB-3.5	BP-7	SP-2.5	T-15F

Reference pages: C-PCLNR/L-CHP, C-ACLNN: Inserts → **B054** -, CBN → **B168** -, PCD → **B211** -



TUNGCAP

C-AWLNR/L

Double-clamp toolholder, with 95° approach angle, for negative 80° trigon inserts

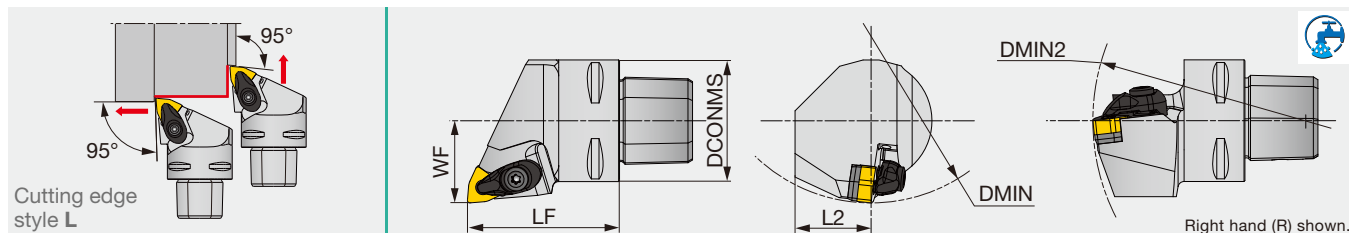

Designation	DCONMS	LF	L2	WF	DMIN	DMIN2	RE	Insert
C3AWLNR/L22045-0604N	32	45	20	22	140	120	0.8	WN**0604...
C3AWLNR/L22045-08N	32	45	20	22	110	170	0.8	WN**0804...
C4AWLNR/L27050-0604N	40	50	25	27	140	110	0.8	WN**0604...
C4AWLNR/L27050-08N	40	50	25	27	-	-	0.8	WN**0804...
C6AWLNR/L45065-08N	63	65	35	45	190	110	0.8	WN**0804...

Applicable for 7 MPa coolant

The items without DMIN and DMIN2 cannot be used for boring.

SPARE PARTS

Designation	Clamp	Clamp screw	Shim	Shim screw	Spring	Spring pin	Wrench
C-AWLNR/L	ACP4S	ACS-5W	ASW422	CSTB-3.5	BP-7	SP-2.5	T-15F

C-PWLNR/L-CHP

Lever-lock toolholder, for negative 80° trigon inserts, with high pressure coolant capability

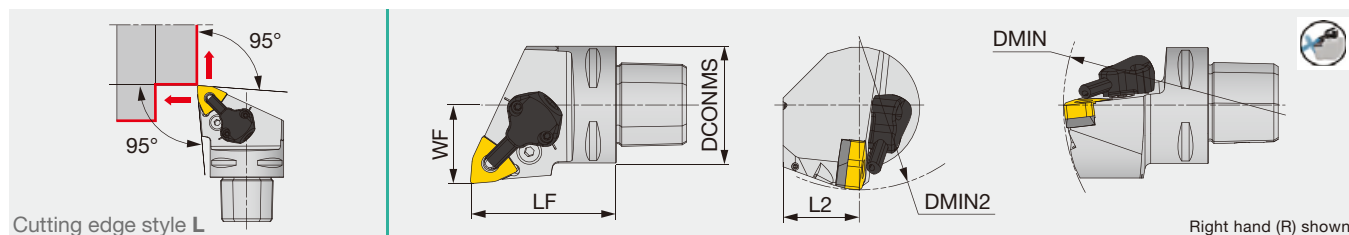

Designation	DCONMS	LF	L2	WF	DMIN	DMIN2	RE	Insert
C4PWLNR/L27050-0604-CHP	40	50	25	27	140	110	0.8	WN**0604...
C4PWLNR/L27050-08-CHP	40	50	25	27	140	110	0.8	WN**0804...
C6PWLNR/L45065-08-CHP	63	65	41	45	190	125	0.8	WN**0804...

Applicable for 14 MPa coolant

SPARE PARTS

Designation	Shim	Clamping screw	Spring pin	Lever	Wrench
C*PWLNR/L**-08-CHP	LSW42BL	LCS4	LSP4	LCL4	P-3
C*PWLNR/L**0604-CHP	LSW312	LCS3	LSP3	LCL3	P-2.5

COOLANT SET

Designation	Coolant unit	Mounting screw	Wrench	O-ring
C*PWLNR/L**-CHP	CU-CW-CHP	SRM3	T-8F	OR6.4X0.9N

Reference pages: C-AWLNR/L, C-PWLNR/L-CHP: Inserts → **B099 -**, CBN → **B179**

C-SCLCL-CHP

Screw-on toolholder, with 95° approach angle, for positive 80° rhombic inserts, with high pressure coolant capability

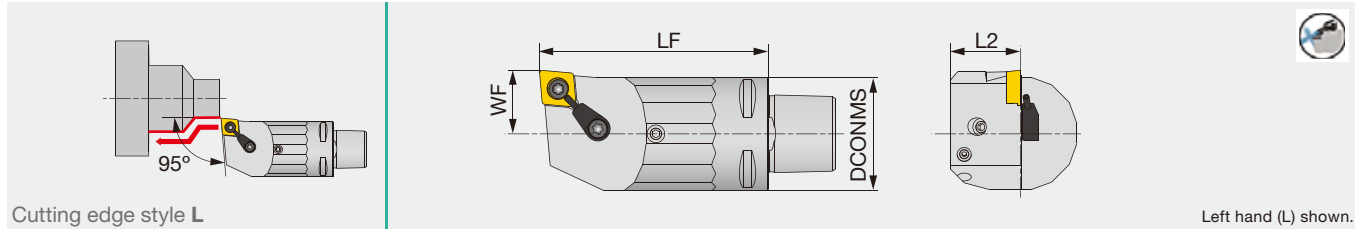

Cutting edge style L

Left hand (L) shown.

Designation	DCONMS	LF	L2	WF	RE	Insert
C3SCLCL18040-09-CHP	32	40	20	18	0.8	CC**09T3...
C3SCLCL18065-09-CHP	32	65	20	18	0.8	CC**09T3...

Applicable for 14 MPa coolant
Cannot be used for boring

SPARE PARTS

Designation	Clamping screw	Coolant unit	Wrench
C3SCLCL...	CSTB-4S	S-CU-CHP	T-15F

C-ADJNR/L

Double-clamp toolholder, with 93° approach angle, for negative 55° rhombic inserts

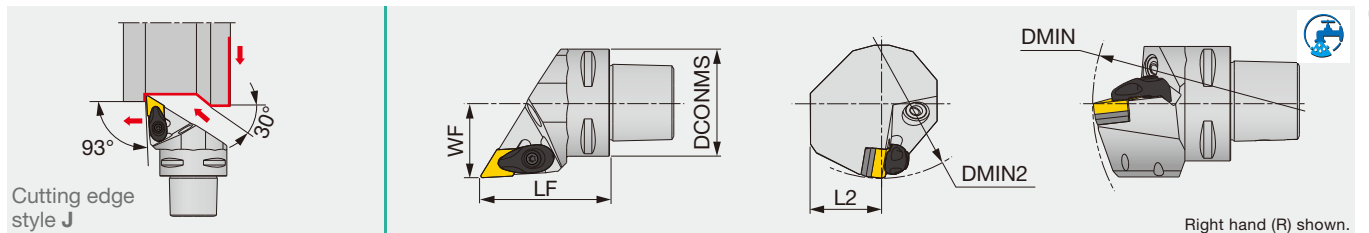

Cutting edge style J

Right hand (R) shown.

Designation	DCONMS	LF	L2	WF	DMIN	DMIN2	RE	Insert
C3ADJNR/L22045-1104N	32	45	20	22	121	85	0.8	DN**1104...
C3ADJNR/L22050-1104N	32	50	20	22	121	85	0.8	DN**1104...
C3ADJNR/L22050-15N	32	50	20	22	121	85	0.8	DN**1504...
C4ADJNR/L27050-1104N	40	50	25	27	145	110	0.8	DN**1104...
C4ADJNR/L27050-15N	40	50	25	27	145	110	0.8	DN**15...
C5ADJNR/L35060-15N	50	60	32	35	165	110	0.8	DN**15...
C6ADJNR/L45065-1104N	63	65	35	45	190	110	0.8	DN**1104...
C6ADJNR/L45065-15N	63	65	41	45	190	110	0.8	DN**15...
C6ADJNR/L45135-15N	63	135	41	45	190	110	0.8	DN**15...

Applicable for 7 MPa coolant

SPARE PARTS

Designation	Clamp	Clamping screw	Coolant parts	Shim	Shim screw	Spring	Spring pin	Wrench
C3ADJNR/L*-1104N	ACP3S-E	ACS-5W	-	ASD322	CSTB-3.5	BP-7	SP-2.5	T-15F
C3ADJNR/L*-15N	ACP4S	ACS-5W	-	ASD432	CSTB-3.5	BP-7	SP-2.5	T-15F
C4ADJNR/L*-1104N	ACP3S-E	ACS-5W	SATZ-M10X1-M5	ASD322	CSTB-3.5	BP-7	SP-2.5	T-15F
C4ADJNR/L*-15N	ACP4S	ACS-5W	SATZ-M10X1-M5	ASD432	CSTB-3.5	BP-7	SP-2.5	T-15F

Option: ASD423 (Shim for DN**1506**)

Reference pages: C-SCLCL-CHP: Inserts → **B112 -**, CBN → **B191**, PCD → **B213**
C-ADJNR/L: Inserts → **B066 -**, CBN → **B172 -**, PCD → **B211**

Lever-lock toolholder, with 93° approach angle, for negative 55° rhombic inserts

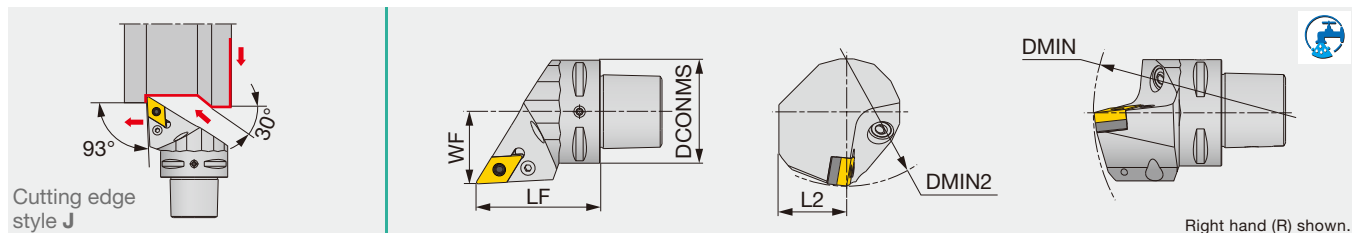

Designation	DCONMS	LF	L2	WF	DMIN	DMIN2	RE	Insert
C5PDJNR/L35060-15N	50	60	32	35	165	110	0.8	DN**1504(06)
C6PDJNR/L45065-15N	63	65	41	45	195	95	0.8	DN**1504(06)

Applicable for 7 MPa coolant

SPARE PARTS

Designation	Coolant parts	Shim	Lever	Clamping screw	Spring pin	Wrench
C5PDJN*35060-15N	SATZ-M10X1-M5	LSD43A	LCL4	LCS4	LSP4	P-3
C6PDJN*45065-15N	SATZ-M10X1-M5	LSD43A	LCL4	LCS4	LSP4S	P-3

Option: LSD42A (Shim for DN**1506**), LSP4S (Spring pin for DN**1506**)

C-PDJNR/L-CHP

Lever-lock toolholder, with 93° approach angle, for negative 55° rhombic inserts, with high pressure coolant capability

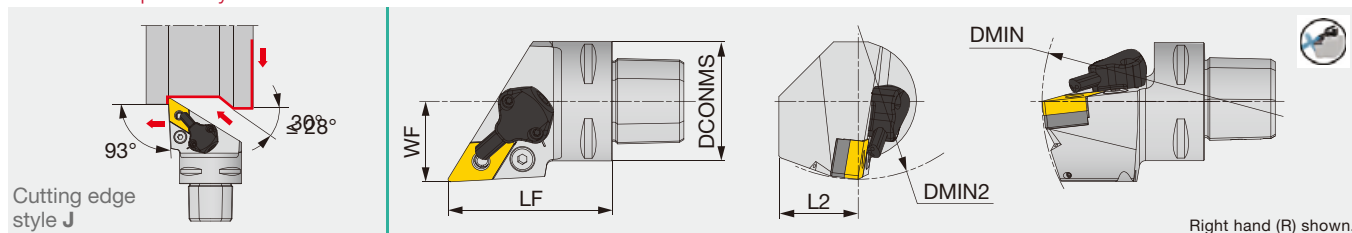

Designation	DCONMS	LF	L2	WF	DMIN	DMIN2	RE	Insert
C4PDJNR/L27055-1104-CHP	40	55	27	27	145	110	0.8	DN**1104...
C4PDJNR/L27055-15-CHP	40	55	27	27	145	110	0.8	DN**1504(06)...
C5PDJNR/L35060-15-CHP	50	60	32	35	165	110	0.8	DN**1504(06)...
C6PDJNR/L45065-1104-CHP	63	65	35	45	195	95	0.8	DN**1104...
C6PDJNR/L45065-15-CHP	63	65	35	45	195	95	0.8	DN**1504(06)...

Applicable for 14 MPa coolant

SPARE PARTS

Designation	Shim	Clamping screw	Spring pin	Lever	Wrench
C*PDJNR/L**-15-CHP	LSD43A	LCS4	LSP4	LCL4	P-3
C*PDJNR/L**1104-CHP	ELSD32	LCS3	LSP3	LCL33L	P-2.5

Option: LSD42A (Shim for DN**1506**), LSP4S (Spring pin for DN**1506**)

COOLANT SET

Designation	Coolant unit	Mounting screw	Wrench	O-ring
C*PDJLNR/L**-CHP	CU-D-CHP	SRM3	T-8F	OR6.4X0.9N

Reference pages: C-PDJNR/L, C-PDJNR/L-CHP: Inserts → **B066 -**, CBN → **B172 -**, PCD → **B211**

C-ATJNR/L

Double-clamp toolholder, with 93° approach angle, for negative 60° triangular inserts

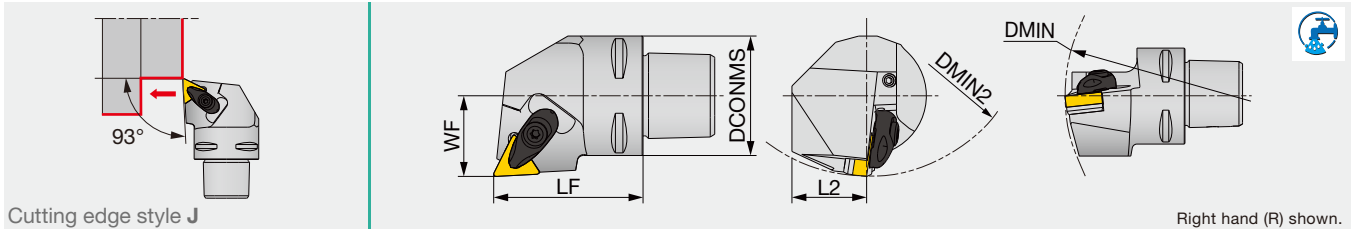

Designation	DCONMS	LF	L2	WF	DMIN	DMIN2	RE	Insert
C3ATJNR/L22040-16N	32	40	20	22	200	140	0.8	TN**1604...
C4ATJNR/L27050-16N	40	50	25	27	140	110	0.8	TN**1604...

Applicable for 7 MPa coolant

Designation	Clamp	Clamp screw	Shim	Shim screw	Spring	Spring pin	Wrench
C4ATJNR/L...	ACP3S	ACS-5W	AST322	CSTB-3.5	BP-7	SP-2.5	T-15F

C-PTJNR/L

Lever-lock toolholder, with 93° approach angle, for negative 60° triangular inserts

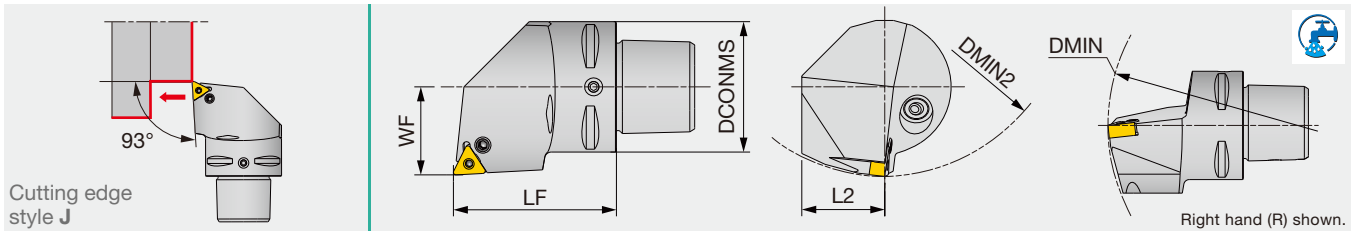

Designation	DCONMS	LF	L2	WF	DMIN	DMIN2	RE	Insert
C4PTJNR/L27050-1104N	40	50	25	27	140	110	0.8	TN**1104**E

Applicable for 7 MPa coolant

Designation	Coolant parts	Lever	Clamping screw	Wrench
C4PTJNR/L27050-1104N	SATZ-M8X1-M3	LCL23	LCS23A	P-2.5

Double-clamp toolholder, with 93° approach angle, for negative 35°/25° rhombic inserts

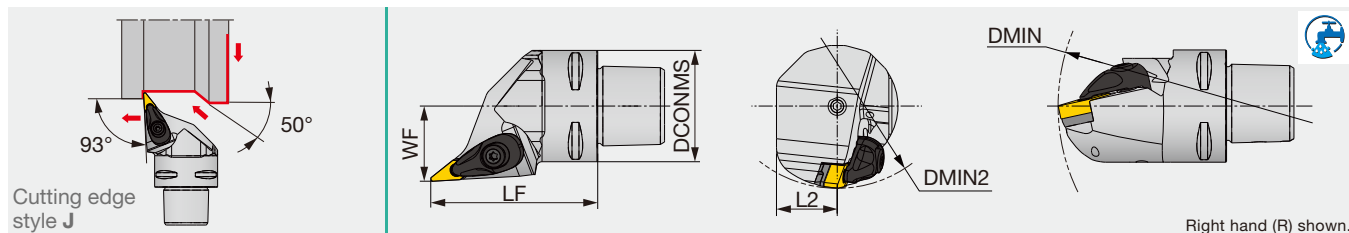

Designation	DCONMS	LF	L2	WF	DMIN	DMIN2	RE	Insert
C3AVJNR/L22050-1204N	32	50	20	22	121	70	0.8	VN**1204...
C4AVJNR/L27060-1204N	40	60	20	27	140	55	0.8	VN**1204...
C4AVJNR/L27060-16N	40	60	25	27	140	110	0.8	V/YN**1604...
C6AVJNR/L45065-1204N	63	65	31.5	45	190	81	0.8	VN**1204...
C6AVJNR/L45065-16N	63	65	35	45	190	81	0.8	V/YN**1604...

Applicable for 7 MPa coolant

SPARE PARTS

Designation	Clamp	Clamp screw	Coolant parts	Shim	Shim screw	Spring	Spring pin	Wrench 1	Wrench 2
C4AVJNR/L27060-1204N	ACP3L-E	ACS-5W	-	ASV222	CSTB-3	BP-7	SP-2.5	T-9F	T-15F
C4AVJNR/L27060-16N	ACP3L	ACS-5W	-	ASV322	CSTB-3.5	BP-7	SP-2.5	-	T-15F
C6AVJNR/L45065-1204N	ACP3L-E	ACS-5W	SATZ-M10X1-M5	ASV222	CSTB-3	BP-7	SP-2.5	T-9F	T-15F
C6AVJNR/L45065-16N	ACP3L	ACS-5W	SATZ-M10X1-M5	ASV322	CSTB-3.5	BP-7	SP-2.5	-	T-15F

C-PVJNR/L-CHP

Lever-lock toolholder, with 93° approach angle, for negative 35°/25° rhombic inserts, with high pressure coolant capability

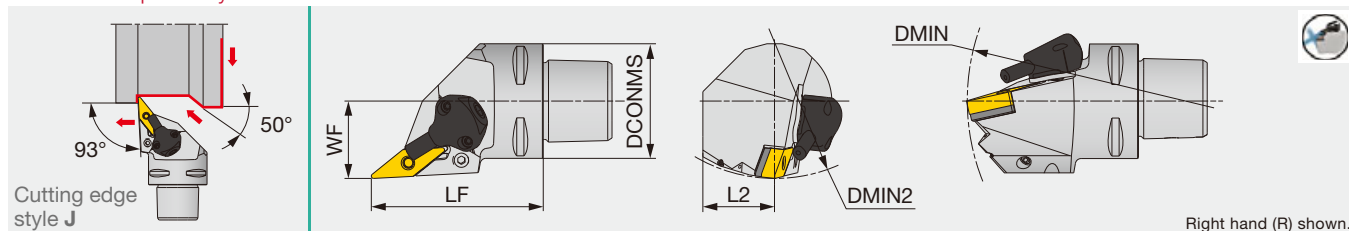

Designation	DCONMS	LF	L2	WF	DMIN	DMIN2	RE	Insert
C4PVJNR/L27060-16-CHP	40	60	25	27	140	110	0.8	V/YN**1604...
C6PVJNR/L45065-16-CHP	63	65	32	45	190	81	0.8	V/YN**1604...

Applicable for 14 MPa coolant

SPARE PARTS

Designation	Shim	Spring pin	Lever	Clamping screw	Wrench	Coolant unit
C*PVJNR/L...16-CHP	LSV317	LSP3	LCL3V	LCS3V	P-2.5	CU-V-CHP

COOLANT SET

Designation	Coolant unit	Mounting screw	Wrench 2	O-ring
C*PVJNR/L...16-CHP	CU-V-CHP	SRM3	T-8F	OR6.4X0.9N

Reference pages: C-AVJNR/L, C-PVJNR/L-CHP: Inserts → **B094 - , B110**, CBN → **B186 - B188**, PCD → **B212**

C-SDJCR/L-CHP

Screw-on toolholder, with 93° approach angle, for positive 55° rhombic inserts, with high pressure coolant capability

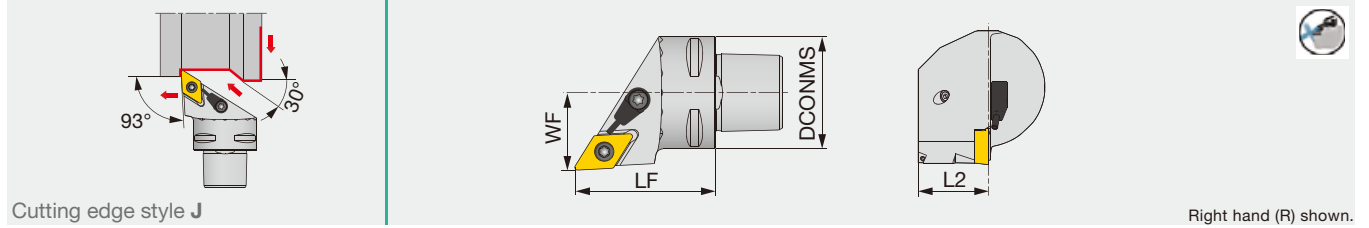

Designation	DCONMS	LF	L2	WF	RE	Insert
C3SDJCR/L22040-11-CHP	32	40	20	22	0.8	DC**11T3...

Applicable for 14 MPa coolant
Cannot be used for boring

SPARE PARTS

Designation	Clamping screw	Coolant unit	Wrench
C3SDJCR/L22040-11-CHP	CSTB-4S	S-CU-CHP	T-15F

C-SVJCR/L

Screw-on toolholder, with 93° approach angle, for positive 35° rhombic inserts

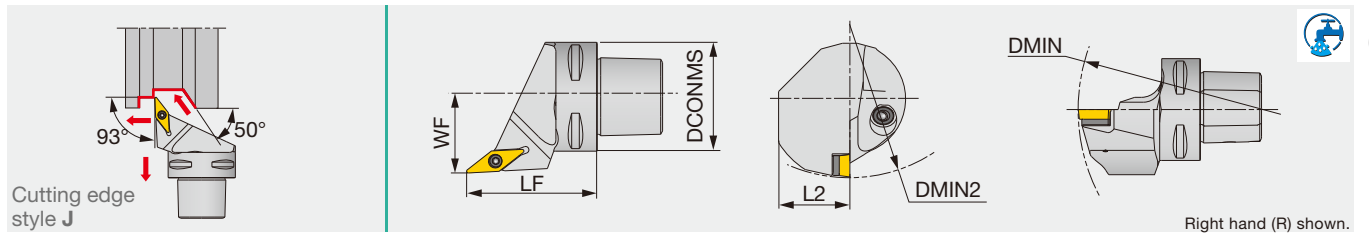

Designation	DCONMS	LF	L2	WF	DMIN	DMIN2	RE	Insert
C3SVJCR/L22040-11N ⁽²⁾	32	40	20	22	-	-	0.4	VC**1103...
C3SVJCR/L22045-16N	32	45	20	22	-	-	0.8	VC**1604...
C4SVJCR/L27050-16N ⁽²⁾	40	50	25	27	140	155	0.8	VC**1604...
C5SVJCL35060-16 ⁽¹⁾	50	60	32	35	-	-	0.8	VC**1604...
C5SVJCR/L35060-16N ⁽²⁾	50	60	32	35	170	160	0.8	VC**1604...
C6SVJCR/L45065-16 ⁽¹⁾	63	65	41	45	-	-	0.8	VC**1604...
C6SVJCR/L45065-16N ⁽²⁾	63	65	41	45	170	190	0.8	VC**1604...

• The items without DMIN and DMIN2 cannot be used for boring
(1) Applicable for 3 MPa coolant (2) Applicable for 7 MPa coolant

SPARE PARTS

Designation	Clamping screw	Coolant parts	Shim	Shim screw	Wrench 1	Wrench 2
C3SVJC*22040-11N	CSTB-2.5	SATZ-M8X1-M3	-	-	-	T-8F
C3SVJC*22045-16N	CSTB-3.5L	-	SSV32	DTS5-3.5	P-3.5	T-15F
C4SVJC*27050-16N	CSTB-3.5L	SATZ-M10X1-M5	SSV32	DTS5-3.5	P-3.5	T-15F
C5SVJC*35060-16	CSTB-3.5L	EZ104	SSV32	DTS5-3.5	P-3.5	T-15F
C5SVJC*35060-16N	CSTB-3.5L	SATZ-M10X1-M5	SSV32	DTS5-3.5	P-3.5	T-15F
C6SVJC*45065-16	CSTB-3.5L	EZ104	SSV32	DTS5-3.5	P-3.5	T-15F
C6SVJC*45065-16N	CSTB-3.5L	SATZ-M10X1-M5	SSV32	DTS5-3.5	P-3.5	T-15F

Reference pages: C-SDJCR/L-CHP: Inserts → **B121** -, CBN → **B194** -, PCD → **B214** -
C-SVJCR/L: Inserts → **B152** -, CBN → **B209** -, PCD → **B220**

Screw-on toolholder, with 72.5° approach angle, for positive 35° rhombic inserts

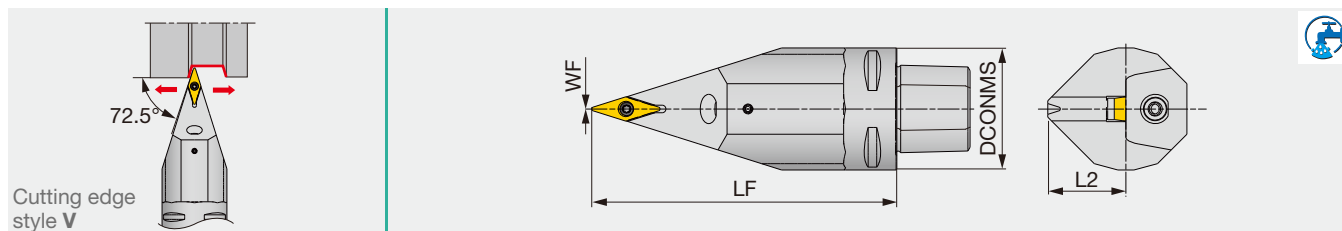

Designation	DCONMS	LF	L2	WF	RE	Insert
C5SVVCN00090-16 ⁽¹⁾	50	90	32	0	0.8	VC**1604...
C5SVVCN00090-16N ⁽²⁾	50	90	32	0	0.8	VC**1604...
C5SVVCN00125-16 ⁽¹⁾	50	125	32	0	0.8	VC**1604...
C5SVVCN00125-16N ⁽²⁾	50	125	32	0	0.8	VC**1604...
C6SVVCN00100-16N ⁽²⁾	63	100	37.5	0	0.8	VC**1604...
C6SVVCN00140-16N ⁽²⁾	63	140	37.5	0	0.8	VC**1604...

(1) Applicable for 3 MPa coolant (2) Applicable for 7 MPa coolant

SPARE PARTS

Designation	Clamping screw	Coolant parts	Shim	Shim screw	Wrench 1	Wrench 2
C5SVVCN00090-16	CSTB-3.5L	EZ104	SSV32	DTS5-3.5	P-3.5	T-15F
C5SVVCN00090-16N	CSTB-3.5L	SATZ-M10X1-M5	SSV32	DTS5-3.5	P-3.5	T-15F
C5SVVCN00125-16	CSTB-3.5L	EZ104	SSV32	DTS5-3.5	P-3.5	T-15F
C5SVVCN00125-16N	CSTB-3.5L	SATZ-M10X1-M5	SSV32	DTS5-3.5	P-3.5	T-15F
C6SVVCN00100-16	CSTB-3.5L	EZ104	SSV32	DTS5-3.5	P-3.5	T-15F
C6SVVCN00100-16N	CSTB-3.5L	SATZ-M10X1-M5	SSV32	DTS5-3.5	P-3.5	T-15F
C6SVVCN00140-16	CSTB-3.5L	EZ104	SSV32	DTS5-3.5	P-3.5	T-15F
C6SVVCN00140-16N	CSTB-3.5L	SATZ-M10X1-M5	SSV32	DTS5-3.5	P-3.5	T-15F

C-ADNNN

Double-clamp toolholder, with 63° approach angle, for negative 55° rhombic inserts

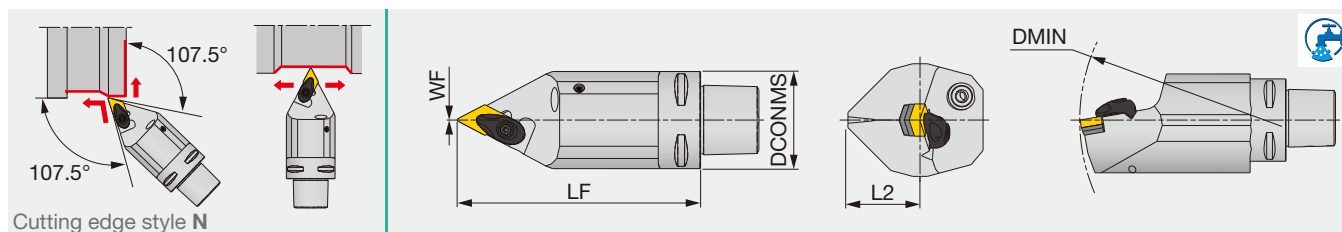

Designation	DCONMS	LF	L2	WF	DMIN	RE	Insert
C5ADNNN00090-15 ⁽¹⁾	50	90	32	0	-	0.8	DN**1504(06)
C5ADNNN00090-15N ⁽²⁾	50	90	32	0	165	0.8	DN**1504(06)
C5ADNNN00125-15 ⁽¹⁾	50	125	32	0	-	0.8	DN**1504(06)
C5ADNNN00125-15N ⁽²⁾	50	125	32	0	165	0.8	DN**1504(06)
C6ADNNN00100-15N ⁽²⁾	63	100	37.5	0	190	0.8	DN**1504(06)
C6ADNNN00140-15 ⁽¹⁾	63	140	37.5	0	-	0.8	DN**1504(06)
C6ADNNN00140-15N ⁽²⁾	63	140	37.5	0	190	0.8	DN**1504(06)

• The items without DMIN cannot be used for boring

(1) Applicable for 3 MPa coolant (2) Applicable for 7 MPa coolant

SPARE PARTS

Designation	Clamp	Clamp screw	Coolant parts	Shim	Shim screw	Spring	Spring pin	Wrench
C5ADNNN00090-15	ACP4S	ACS-5W	EZ104	ASD432	CSTB-3.5	BP-7	SP-2.5	T-15F
C5ADNNN00090-15N	ACP4S	ACS-5W	SATZ-M10X1-M5	ASD432	CSTB-3.5	BP-7	SP-2.5	T-15F
C5ADNNN00125-15	ACP4S	ACS-5W	EZ104	ASD432	CSTB-3.5	BP-7	SP-2.5	T-15F
C5ADNNN00125-15N	ACP4S	ACS-5W	SATZ-M10X1-M5	ASD432	CSTB-3.5	BP-7	SP-2.5	T-15F
C6ADNNN00100-15	ACP4S	ACS-5W	EZ104	ASD432	CSTB-3.5	BP-7	SP-2.5	T-15F
C6ADNNN00100-15N	ACP4S	ACS-5W	SATZ-M10X1-M5	ASD432	CSTB-3.5	BP-7	SP-2.5	T-15F
C6ADNNN00140-15	ACP4S	ACS-5W	EZ104	ASD432	CSTB-3.5	BP-7	SP-2.5	T-15F
C6ADNNN00140-15N	ACP4S	ACS-5W	SATZ-M10X1-M5	ASD432	CSTB-3.5	BP-7	SP-2.5	T-15F

Option: ASD423 (Shim for DN**1506**)

Reference pages: C-SVVCN: Inserts → **B152 -**, CBN → **B209**, PCD → **B220**

C-ADNNN: Inserts → **B066 -**, CBN → **B172 -**, PCD → **B211**

C-ADQNR/L

Double-clamp toolholder, with 107.5° approach angle, for negative 55° rhombic inserts

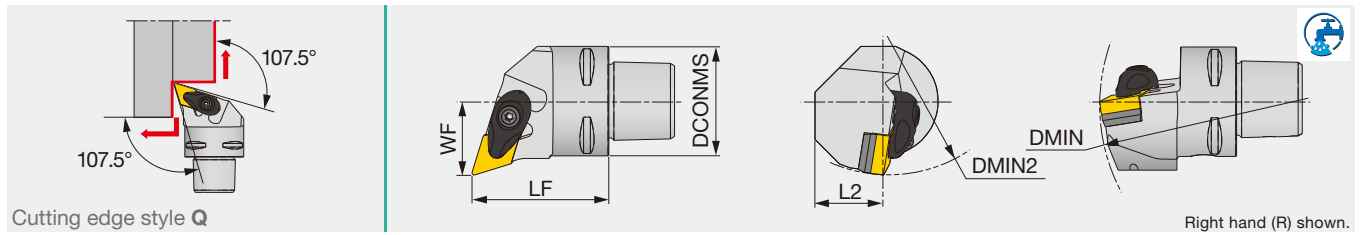

Designation	DCONMS	LF	L2	WF	DMIN	DMIN2	RE	Insert
C3ADQNR/L22040-15N	32	40	20	22	121	85	0.8	DN**1504...
C4ADQNR/L27050-15N	40	50	25	27	145	110	0.8	DN**1504...

Applicable for 7 MPa coolant

SPARE PARTS							
Designation	Clamp	Clamp screw	Shim	Shim screw	Spring	Spring pin	Wrench
C*ADQNR/L...	ACP4S	ACS-5W	ASD432	CSTB-3.5	BP-7	SP-2.5	T-15F

Option: ASD423 (Shim for DN**1506**)

C-AVQNR/L

Double-clamp toolholder, with 117.5° approach angle, for negative 35°/25° rhombic inserts

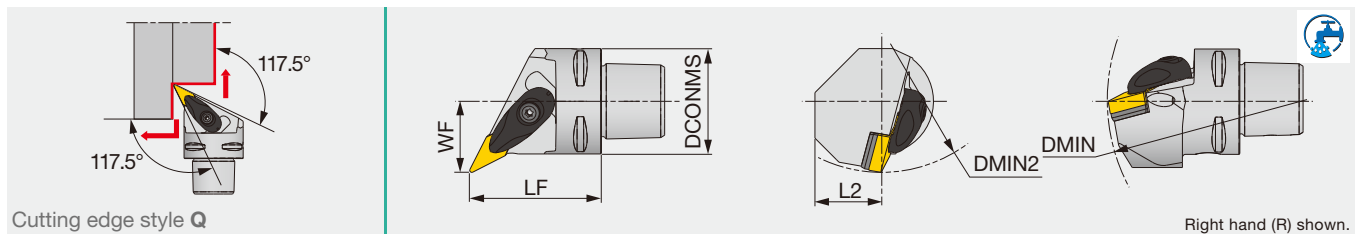

Designation	DCONMS	LF	L2	WF	DMIN	DMIN2	RE	Insert
C4AVQNR/L27050-16N	40	50	25	27	145	110	0.8	V/YN**1604...

Applicable for 7 MPa coolant

SPARE PARTS							
Designation	Clamp	Clamp screw	Shim	Shim screw	Spring	Spring pin	Wrench
C4AVQNR/L27050-16N	ACP3L	ACS-5W	ASV322	CSTB-3.5	BP-7	SP-2.5	T-15F

Reference pages: C-ADQNR/L: Inserts → **B066 -**, CBN → **B172 -**, PCD → **B211**
 C-AVQNR/L: Inserts → **B098 -**, **B110**, CBN → **B186 - B188**, PCD → **B212**

Double-clamp toolholder, with 50° approach angle, for negative 80° rhombic inserts

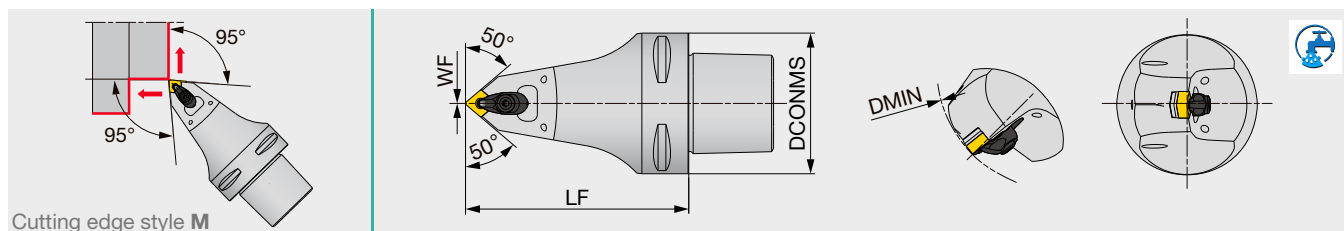

Cutting edge style M

Designation	DCONMS	LF	WF	DMIN	RE	Insert
C6ACMNN00100-0904N	63	100	0	110	0.8	CN**0904**E
C6ACMNN00140-0904N	63	140	0	110	0.8	CN**0904**E
C6ACMNN00100-12N	63	100	0	110	0.8	CN**1204...
C6ACMNN00140-12N	63	140	0	110	0.8	CN**1204...

Applicable for 7 MPa coolant

SPARE PARTS

Designation	Clamp	Clamping screw	Shim	Shim screw	Spring	Spring pin	Wrench
C6ACMNN001*-0904N	ACP3S-E	ACS-5W	ASC322	CSTB-3.5	BP-7	SP-2.5	T-15F
C6ACMNN001*-12N	ACP4S	ACS-5W	ASC422	CSTB-3.5	BP-7	SP-2.5	T-15F

C-PCMNN-CHP

Lever-lock toolholder, with 50° approach angle, for negative 80° rhombic inserts, with high pressure coolant capability

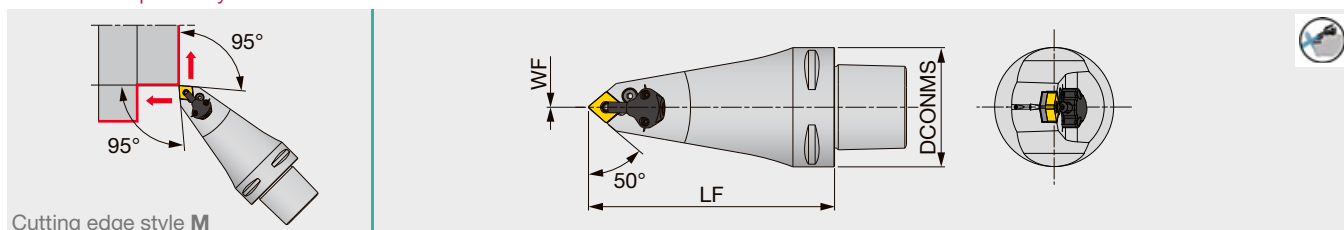

Cutting edge style M

Designation	DCONMS	LF	WF	RE	Insert
C6PCMNN00130-12-CHP	63	130	0	0.8	CN**1204...

Applicable for 14 MPa coolant

Cannot be used for boring.

SPARE PARTS

Designation	Shim	Spring pin	Lever	Clamping screw	Wrench	Coolant unit
C6PCMNN00130-12-CHP	LSC42	LSP4	LCL4	LCS4	P-3	CU-CW-CHP

COOLANT SET

Designation	Coolant unit	Mounting screw	Wrench 2	O-ring
C6PCMNN00130-12-CHP	CU-CW-CHP	SRM3	T-8F	OR6.4X0.9N

Reference pages: C-ACMNN, C-PCMNN-CHP: Inserts → **B054** -, CBN → **B168** -, PCD → **B211** -

C-PDMNL-CHP

Lever-lock toolholder, with 48° approach angle, for negative 55° rhombic inserts, with high pressure coolant capability

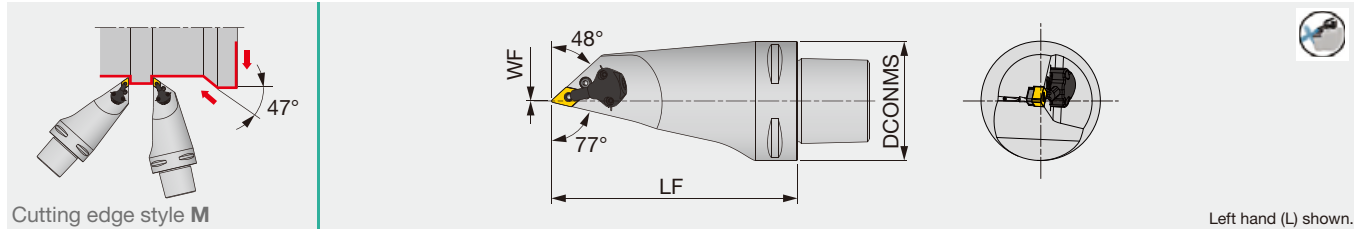

Cutting edge style M

Left hand (L) shown.

Designation	DCONMS	LF	WF	RE	Insert
C6PDMNL00130-1104-CHP	63	130	0	0.8	DN**1104...

Applicable for 14 MPa coolant Cannot be used for boring

SPARE PARTS

Designation	Shim	Spring pin	Lever	Clamping screw	Wrench	Coolant unit
C6PDMNL00130-1104-CHP	ELSD32	LSP3	LCL33L	LCS3	P-2.5	CU-D-CHP

COOLANT SET

Designation	Coolant unit	Mounting screw	Wrench 2	O-ring
C6PDMNL00130-1104-CHP	CU-D-CHP	SRM3	T-8F	OR6.4X0.9N

C-ADUNR/L

Double-clamp toolholder, with 93° approach angle, for negative 55° rhombic inserts

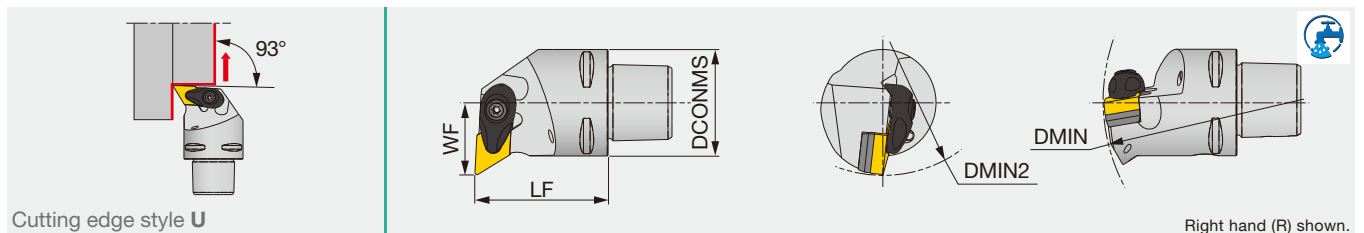

Cutting edge style U

Right hand (R) shown.

Designation	DCONMS	LF	L2	WF	DMIN	DMIN2	RE	Insert
C4ADUNR/L27050-15N	40	50	-	27	140	110	0.8	DN**1504...

Applicable for 7 MPa coolant

SPARE PARTS

Designation	Clamp	Clamp screw	Shim	Shim screw	Spring	Spring pin	Wrench
C4ADUNR/L27050-15N	ACP4S	ACS-5W	ASD432	CSTB-3.5	BP-7	SP-2.5	T-15F

Option: ASD423 (Shim for DN**1506**)

Reference pages: C-PDMNL-CHP: Inserts → **B066 -**, CBN → **B172**

C-ADUNR/L: Inserts → **B066 -**, CBN → **B172 -**, PCD → **B211**



Screw-on toolholder, with 93° approach angle, for positive 55° rhombic inserts, with high pressure coolant capability

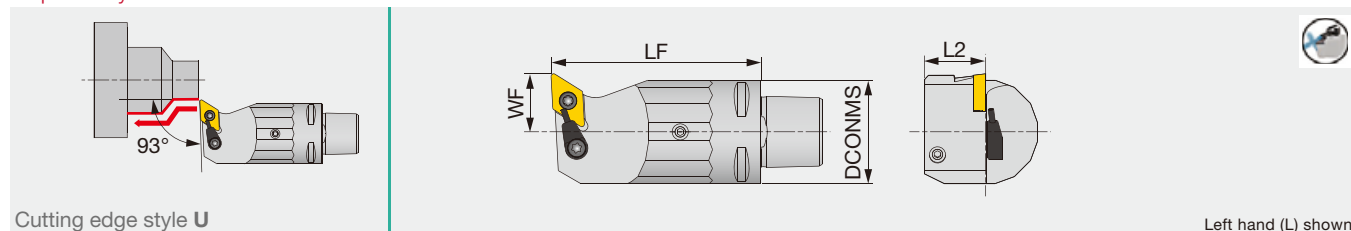

Cutting edge style U

Left hand (L) shown.

Designation	DCONMS	LF	L2	WF	RE	Insert
C3SDUCL18040-11-CHP	32	40	19	18	0.8	DC**11T3...
C3SDUCL18065-11-CHP	32	65	19	18	0.8	DC**11T3...

Applicable for 14 MPa coolant
Cannot be used for boring

SPARE PARTS

Designation	Clamping screw	Coolant unit	Wrench
C3SDUCL...	CSTB-4S	S-CU-CHP	T-15F

C-PTUNL-CHP

Lever-lock toolholder, with 93° approach angle, for negative 60° triangular inserts, with high pressure coolant capability

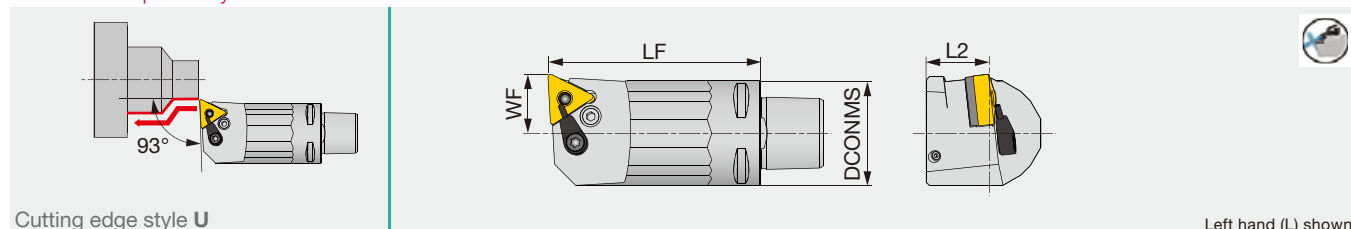

Cutting edge style U

Left hand (L) shown.

Designation	DCONMS	LF	L2	WF	RE	Insert
C3PTUNL18040-16-CHP	32	40	19	18	0.8	TN**1604...
C3PTUNL18065-16-CHP	32	65	19	18	0.8	TN**1604...

Applicable for 14 MPa coolant
Cannot be used for boring

SPARE PARTS

Designation	Coolant unit	Shim	Lever	Clamping screw	Spring pin	Wrench
C3PTUNL...	S-CU-CHP	LST317	LCL3	LCS3	LSP3	P-2.5

C-SVUCL-CHP

Screw-on toolholder, with 93° approach angle, for positive 35° rhombic inserts, with high pressure coolant capability

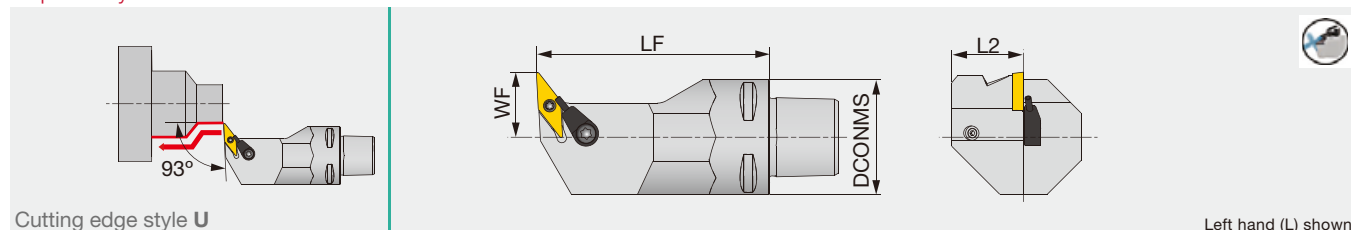

Cutting edge style U

Left hand (L) shown.

Designation	DCONMS	LF	L2	WF	RE	Insert
C3SVUCL18065-11-CHP	32	65	20	18	0.4	VC**1103...

Applicable for 14 MPa coolant
Cannot be used for boring

SPARE PARTS

Designation	Clamping screw	Coolant unit	Wrench
C3SVUCL18065-11-CHP	CSTB-2.5	S-CU-CHP	T-8F

Reference pages: C-SDUCL-CHP: Inserts → **B121 -**, CBN → **B194**, PCD → **B214**
C-PTUNL-CHP: Inserts → **B087 -**, CBN → **B182 -**, PCD → **B212**
C-SVUCL-CHP: Inserts → **B152**

C-ADER/L

Adapter for square shank toolholders

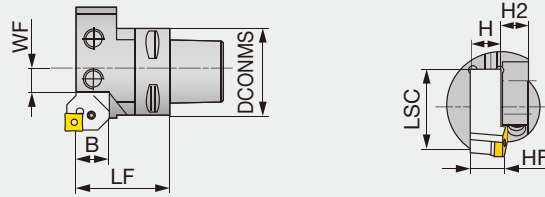

Designation	DCONMS	WF	LF	B	HF	H2	H	LSC
C3ADE-16R/L	32	17	45	16	16	26	16	45
C4ADE-20R/L	40	8	49.2	20	20	26	20	57
C5ADE-20R/L	50	8	55.2	20	20	20	20	57

Regular shank should be shortened. Applicable for 10 MPa coolant

C-ASHA

Adapter for square shank toolholders

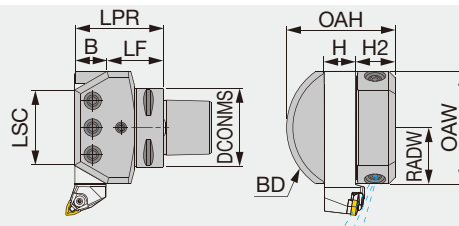

Designation	DCONMS	H	B	LPR	LSC	LF	RADW	OAW	H2	OAH	BD
C5ASHA20	50	20	20	58	46	38	38	76	31.5	76.5	90
C6ASHA20	63	20	20	60	46	40	38	76	31.5	76.5	90
C6ASHA25	63	25	25	71	61	46	45	90	31.6	86.5	110

Applicable for 10 MPa coolant

C-ASHA

Adapter for square shank tool holder, with hose-free direct coolant supply

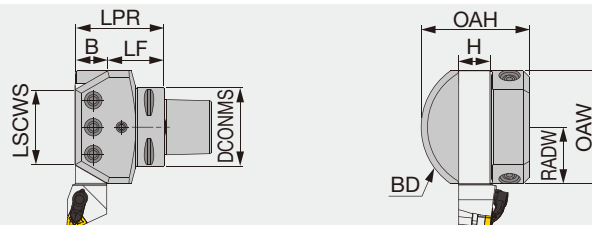

Designation	DCONMS	H	B	LPR	LSCWS	LF	RADW	OAW	OAH	BD
C6ASHA25-HPMC	63	25	25	71	61	46	45	90	86.6	110

Applicable for 7 MPa coolant

C-ASHR/L

Adapter for square shank toolholders

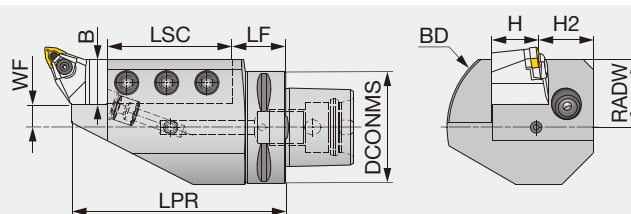

Left hand (L) shown.

Designation	DCONMS	LPR	LSC	LF	WF	H	B	H2	RADW	BD
C4ASHR/L161	40	104	70	34	7	16	16	20	23	60
C5ASHR/L201	50	98	63.5	24.5	10	20	20	33	30	90
C6ASHR/L20-1	63	100	63.5	26.5	10	20	20	33	30	90
C6ASHR251-J	63	120	82	38	4.5	25	25	31.5	29.5	90
C6ASHL251	63	120	70	30	13	25	25	32	38	100
C8ASHR/L32-1	80	140	90	40	8	32	32	32	40	110

Regular shank should be shortened. Applicable for 10 MPa coolant

Adapter for square shank tool holder, with hose-free direct coolant supply

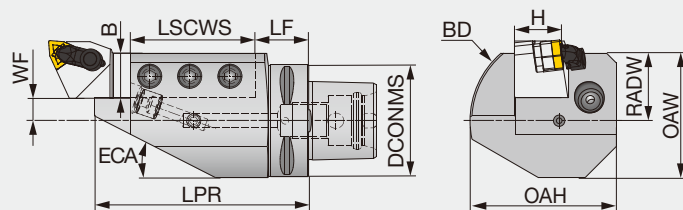

Left hand (L) shown.

Designation	DCONMS	LPR	LSCWS	LF	WF	H	B	OAH	RADW	OAW	BD	ECA
C6ASHR251-J-HPMC*	63	120	82	38	4.5	25	25	76.5	29.5	61	90	27
C6ASHL251-HPMC	63	120	70	30	13	25	25	82	38	70	100	27

* Recommended for Mazak INTEGREX No interference problem on machine magazine.
Applicable for 7 MPa coolant

C-ADES

Adapter for square shank toolholders

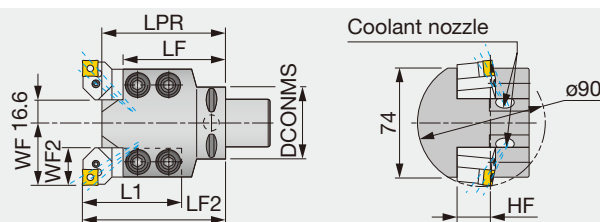

Designation	DCONMS	WF	LF2	LPR	LF	HF	WF2	L1
C4ADES-20	40	41.6	98	85	71	20	25	67
C5ADES-20	50	41.6	98	85	71	20	25	67

Regular shank should be shortened.
Applicable for 10 MPa coolant

C-ASHR/L-45

Adapter for square shank toolholders (with 45° slanted)

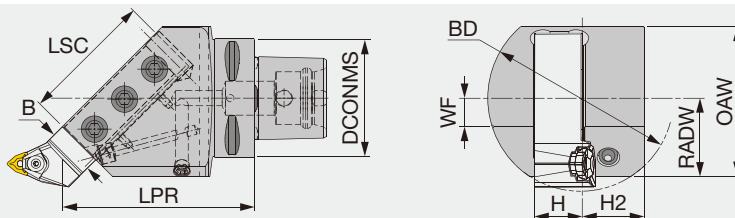

Right hand (R) shown.

Designation	DCONMS	H	B	LSC	LPR	H2	RADW	OAW	WF	BD
C5ASHR/L20-45	50	20	20	-	96.3	26	36	67.5	15	72
C6ASHR/L20-45	63	20	20	70	98.3	26	36	67.5	15	72
C6ASHR/L25-45	63	25	25	70	101.3	33	41.6	79.6	15	100

Regular shank should be shortened.
Applicable for 10 MPa coolant

C-ASHR/L-45-HPMC

Adapter for square shank tool holder, with hose-free direct coolant supply

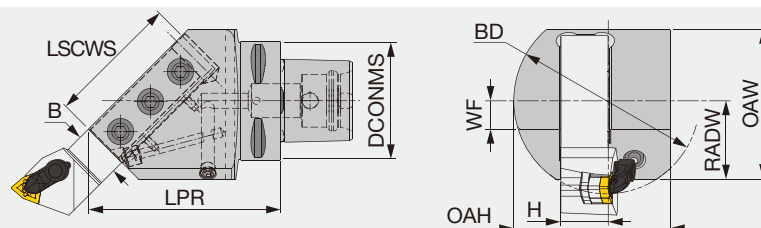

Right hand (R) shown.
Left hand (L) shown for the turning holder.

Designation	DCONMS	H	B	LSCWS	LPR	OAH	RADW	OAW	WF	BD
C6ASHR/L25-45-HPMC	63	25	25	70	102	83	41.6	79.6	15	100

Applicable for 7 MPa coolant

C-SCLCR

Screw-on internal toolholder, for positive 80° rhombic inserts

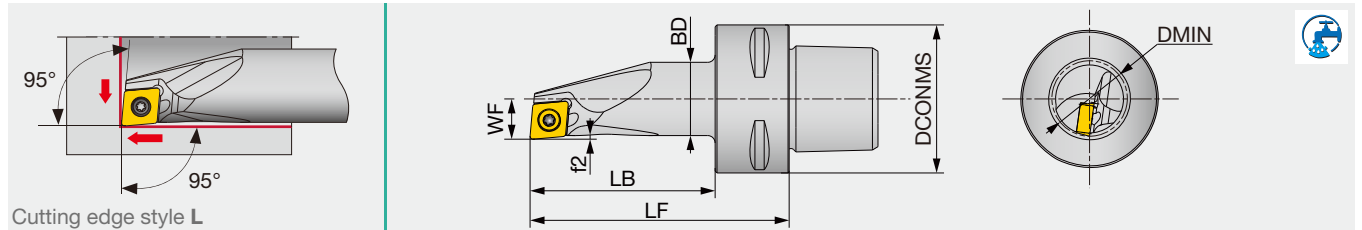

Designation	DMIN	DCONMS	BD	LF	LB	WF	f2	RE	Insert
C3SCLCR11070-09	22	32	19.8	70	52	11	1.0	0.8	CC**09...
C4SCLCR11070-09	22	40	19.8	70	47	11	1.0	0.8	CC**09...

Applicable for 14 MPa coolant
Note: Use right-hand toolholders (R) with left-hand inserts (L).

C-PCLNR/L-IN

Lever-lock internal toolholder, for negative 80° rhombic inserts

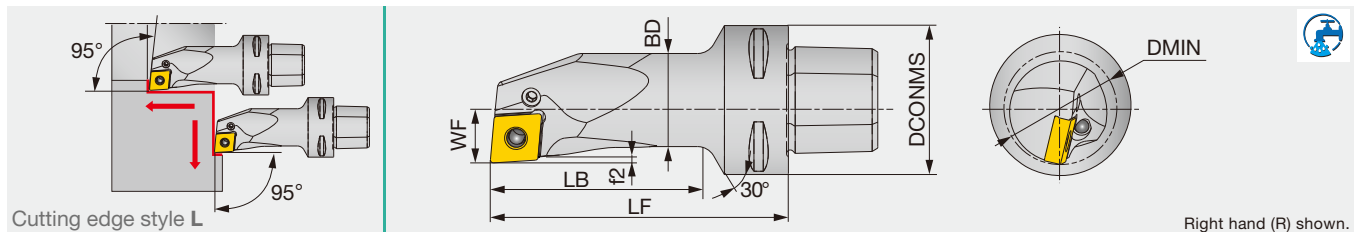

Designation	DMIN	DCONMS	BD	LB	LF	WF	f2	RE	Insert
C3PCLNR17090-12	32	32	25	90	71	17	1.6	0.8	CN**1204...
C4PCLNR17090-0904	32	40	25	90	63	17	1.3	0.8	CN**0904**E
C4PCLNR/L17080-12	32	40	25	80	58.5	17	1.6	0.8	CN**1204...
C4PCLNR22110-0904	40	40	32	110	86.5	22	1.3	0.8	CN**0904**E
C4PCLNR27120-0904	50	40	39.5	120	100	27	1.7	0.8	CN**0904**E

Applicable for 10 MPa coolant

SPARE PARTS

Designation	Lever	Clamping screw	Wrench
C*PCLNR/L...	LCL43N	LCS43	P-2.5

C-PCLNR/L-CHP

Lever-lock internal toolholder, for negative 80° rhombic inserts

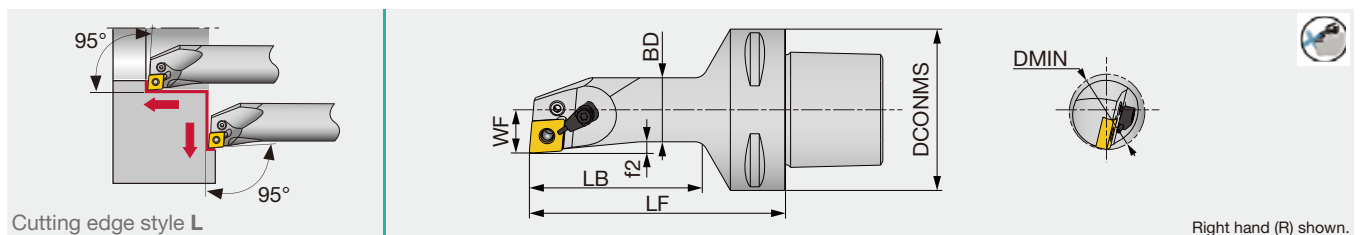

Designation	DMIN	DCONMS	BD	LF	LB	WF	f2	RE	Insert
C6PCLNL17100-12-CHP	32	63	25	100	67.5	17	4.5	0.8	CN**1204...

SPARE PARTS

Designation	Clamping screw	Coolant unit	Wrench	Lever
C6PCLNL17100-12-CHP	LCS43	S-CU-CHP	P-2.5F	LCL43N

Reference pages: C-SCLCR: Inserts → **B112 -**, CBN → **B191**, PCD → **B213**

C-PCLNR/L-IN, C-PCLNR/L-CHP: Inserts → **B054 -**, CBN → **B168 -**, PCD → **B211 -**

Screw-on internal toolholder, for WXGU inserts

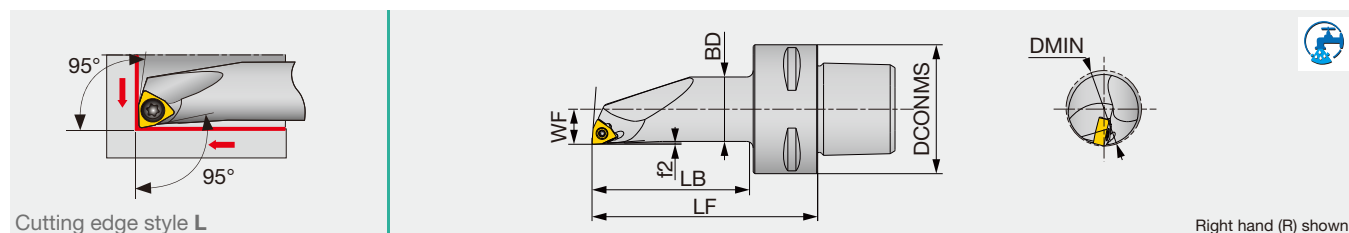

Cutting edge style L

Right hand (R) shown.

Designation	DMIN	DCONMS	BD	LF	LB	WF	f2	RE	Insert
C4SWLXR11070-04	22	40	20	70	47	11	0.4	0.4	WXGU0403**L...

Applicable for 14 MPa coolant

SPARE PARTS

Designation	Clamping screw	Wrench
C4SWLXR11070-04	SR34-514	T-7F

C-ADUNR/L

Double-clamp internal toolholder, for negative 55° rhombic inserts

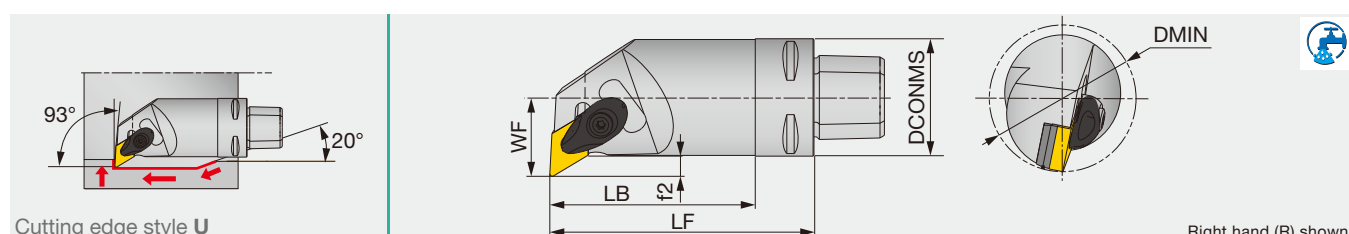

Cutting edge style U

Right hand (R) shown.

Designation	DMIN	DCONMS	LF	LB	WF	f2	RE	Insert
C4ADUNR20070-15	38	40	70	50	20	5	0.8	DN**1504...
C4ADUNR27090-15	50	40	90	-	27	7	0.8	DN**1504...

Applicable for 10 MPa coolant

SPARE PARTS

Designation	Clamp	Clamp screw	Shim	Shim screw	Spring	Spring pin	Wrench
C*ADUNR/L...	ACP4S	ACS-5W	ASD423(04)	CSTB-3.5	BP-7	SP-2.5	T-15F

Option: ASD423 (Shim for DN**1506**)

C-PDUNR/L

Lever-lock internal toolholder, for negative 55° rhombic inserts

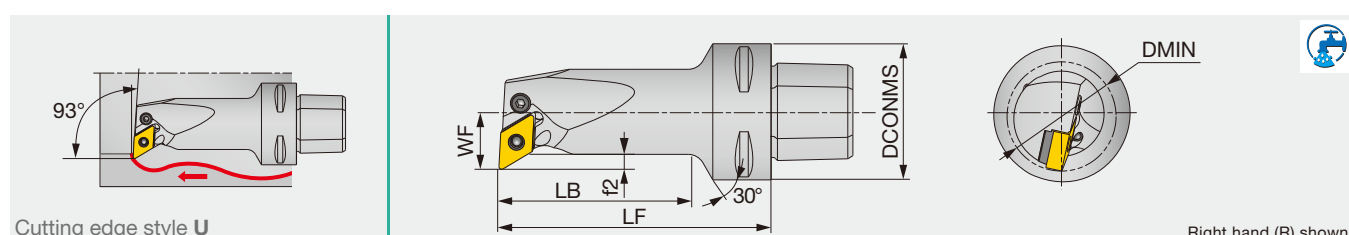

Cutting edge style U

Right hand (R) shown.

Designation	DMIN	DCONMS	LF	LB	WF	f2	RE	Insert
C4PDUNR/L17080-11	32	40	80	58.5	17	4.4	0.8	DN**1104...

Applicable for 10 MPa coolant

SPARE PARTS

Designation	Lever	Clamping screw	Shim	Spring pin	Wrench
C4PDUNR17080-11	LCL33L	LCS3	ELSD317BR	LSP3	P-2.5
C4PDUNL17080-11	LCL33L	LCS3	ELSD317BL	LSP3	P-2.5

Reference pages: C-SWLXR/L: Inserts → **B157 -**

C-ADUNR/L: Inserts → **B066 -**, CBN → **B172 -**, PCD → **B211**

C-PDUNR/L: Inserts → **B066 -**, CBN → **B172**

C-PDUNR/L

Lever-lock internal toolholder, for negative 55° rhombic inserts

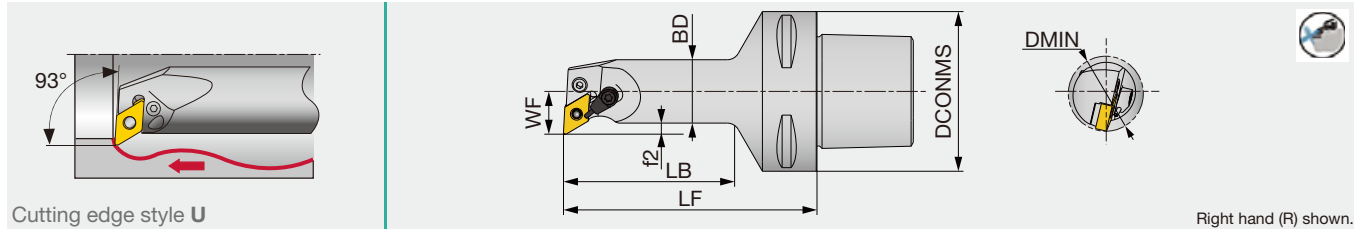

Designation	DMIN	DCONMS	BD	LF	LB	WF	f2	RE	Insert
C6PDUNL17100-1104-CHP	32	63	25	100	67.5	17	4.5	0.8	DN**1104...

Applicable for 14 MPa coolant

SPARE PARTS

Designation	Shim	Clamping screw	Coolant unit	Wrench	Spring pin	Lever
C6PDUNL17100-1104-CHP	ELSD317BL	LCS43	S-CU-CHP	P-2.5	LSP3	LCL33L

C-SDXXR

Screw-on internal toolholder, for DXGU inserts

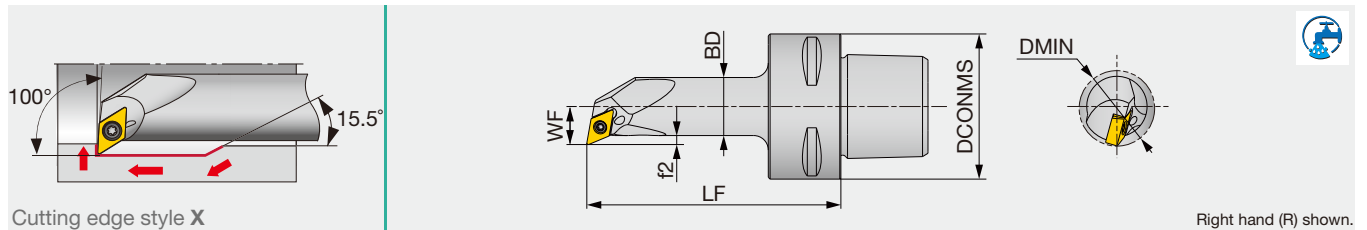

Designation	DMIN	DCONMS	BD	LF	LB	WF	f2	RE	Insert
C3SDXXR11065-07	20	32	16	65	45	10.6	2.5	0.4	DXGU0703**L...
C3SDXXR13080-07	24	32	20	80	62	12.6	2.5	0.4	DXGU0703**L...
C4SDXXR11070-07	20	40	16	70	46	10.6	2.5	0.4	DXGU0703**L...
C4SDXXR13080-07	24	40	20	80	58	12.6	2.5	0.4	DXGU0703**L...

Applicable for 14 MPa coolant

Note: Use right-hand toolholders (R) with left-hand inserts (L).

SPARE PARTS

Designation	Clamping screw	Wrench
C*SDXXR...	SR34-514	T-7F

Reference pages: C-PDUNR/L: Inserts → **B066 -**, CBN → **B172**
C-SDXXR: Inserts → **B126 -**

Screw-on internal toolholder, for positive 35° rhombic inserts

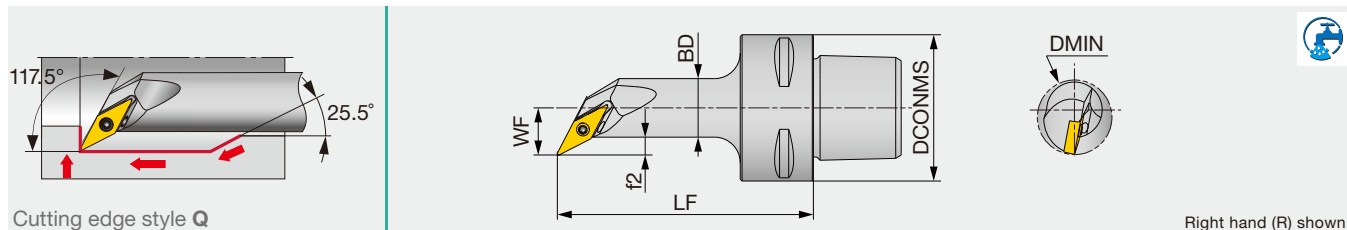

Cutting edge style Q

Right hand (R) shown.

Designation	DMIN	DCONMS	BD	LF	LB	WF	f2	RE	Insert
C3SVQBR13065-11	21.5	32	16	65	45	13	4.9	0.4	VB**11...
C3SVQBR15080-11	25.5	32	20	80	59	15	4.9	0.4	VB**11...
C3SVQBR18090-16	30.5	32	25	90	71	17.5	4.9	0.8	VB**16...
C4SVQBR13070-11	21.5	40	16	70	43	13	4.9	0.4	VB**11...
C4SVQBR15080-11	25.5	40	20	80	52	15	4.9	0.4	VB**11...
C4SVQBR18095-16	30.5	40	25	95	68	17.5	4.9	0.8	VB**16...

Applicable for 14 MPa coolant

SPARE PARTS



Designation	Clamping screw	Wrench
C*SVQBR**-11	CSTB-2.5	T-6F
C*SVQBR**-16	CSTB-3.5	T-15F

C-ABB

Adapter for boring bars

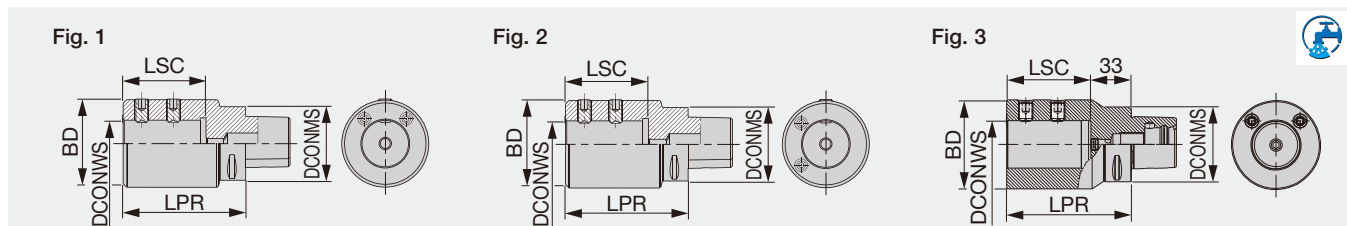

Designation	DCONMS	DCONWS	BD	LPR	LSC	Fig.
C4ABB-25-60	40	25	63	100	60	2
C5ABB-25-60	50	25	63	100	60	2
C6ABB-25-60C*	63	25	63	95	60	1
C6ABB-40-70C*	63	40	75	105	71	3
C8ABB25-60	80	25	63	100	60	2
C8ABB40-72	80	40	75	105	71	2

Use the appropriate outlet screw according to the tool setup.
Applicable for 7 MPa coolant

SPARE PARTS

Designation	Clamp screw		Coolant outlet screw for internal supply	Coolant outlet screw for external supply
	Used on A-type sleeves	Used on B-type sleeves		
C...ABB-25-60/C	SRM10X20DIN915	SRM10X12DIN1835-B	SRM10X6DIN913	SRM6X8DIN913
C6ABB-40-70/C	SRM12X20DIN915	SRM12X16DIN1835-B	SRM10X6DIN913	SRM6X8DIN913
C8ABB25-60	SRM10X20DIN915	SRM10X12DIN1835-B	SRM10X6DIN913	-
C8ABB40-72	SRM12X20DIN915	SRM12X16DIN1835-B	SRM10X6DIN913	-

Reference pages: C-SVQBR/L: Inserts → **B098 -**, CBN → **B207 -**, PCD → **B221 -**

SC

Sleeve for C-ABB adapter

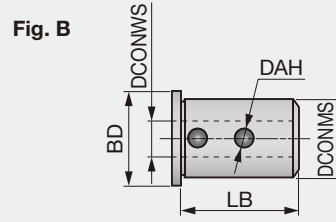
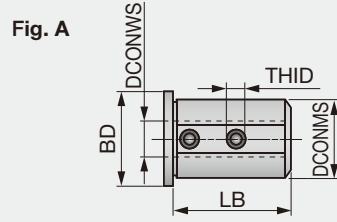

Designation	DCONMS	DCONWS	BD	LB	THID	DAH	Fig.
SC25T6A*	25	6	31	56	M6	-	A
SC25T8A*	25	8	31	56	M8	-	A
SC25T10A*	25	10	31	56	M8	-	A
SC25T12A*	25	12	31	56	M8	-	A
SC25T16B	25	16	31	56	-	12	B
SC25T20B	25	20	31	56	-	12	B
SC40T6A*	40	6	46	58	M6	-	A
SC40T8A*	40	8	46	58	M6	-	A
SC40T10A*	40	10	46	58	M8	-	A
SC40T12A*	40	12	46	58	M8	-	A
SC40T16B	40	16	46	58	-	15	B
SC40T20B	40	20	46	58	-	15	B
SC40T25B	40	25	46	58	-	15	B
SC40T32B	40	32	46	58	-	15	B

*: For machining on standard CNC lathes, always use CxADI holder.
Do not use with CxABB holder due to tool orientation reason.

Grade
Insert
Ext. Toolholder
Int. Toolholder
Threading
Grooving
Miniature tool
Milling cutter
Endmill
Drilling tool
Tooling System
User's Guide
Index



Adapter for boring bars

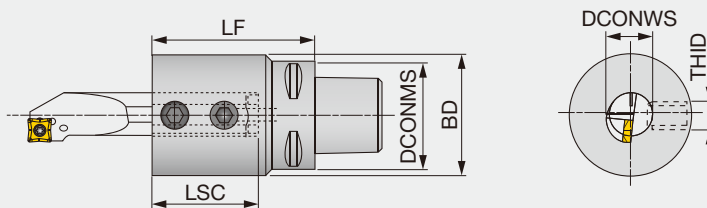

Designation	DCONMS	LF	LSC	DCONWS	BD	THID
C3ADI08x35T	32	35	30	8	28	M6
C3ADI10x35T	32	35	30	10	28	M6
C3ADI10	32	50	20	10	36	M6
C3ADI12x35T	32	35	30	12	32	M6
C3ADI12	32	50	21.5	12	36	M8
C3ADI16x40T	32	40	30	16	36	M8
C3ADI16	32	50	29.5	16	36	M8
C3ADI20x40T	32	40	34	20	36	M8
C4ADI10	40	50	20	10	36	M6
C4ADI12	40	50	24	12	36	M8
C4ADI16	40	50	32	16	36	M8
C4ADI20	40	60	35	20	36	M10
C4ADI25	40	70	45	25	54	M12
C5ADI10	50	60	26	10	36	M6
C5ADI12	50	60	26	12	36	M8
C5ADI16	50	60	32	16	36	M8
C5ADI20	50	60	40	20	36	M10
C5ADI25	50	70	50	25	54	M12
C5ADI32	50	100	76	32	68	M12
C6ADI12	63	65	36	12	36	M8
C6ADI16	63	65	36	16	36	M8
C6ADI20	63	65	40	20	36	M10
C6ADI25	63	76	51	25	54	M12
C6ADI32	63	100	76	32	68	M12
C6ADI40	63	100	76	40	98	M12
C6ADI50	63	115	86	50	98	M12
C8ADI12	80	70	36	12	36	M8
C8ADI16	80	70	36	16	36	M8
C8ADI20	80	70	40	20	36	M10
C8ADI25	80	80	51	25	54	M12
C8ADI32	80	110	86	32	68	M12
C8ADI40	80	115	86	40	98	M12
C8ADI50	80	115	86	50	98	M12

Applicable for 7 MPa coolant

C-CER/L

External threading toolholder, alternative clamping of screw-on or clamp-on

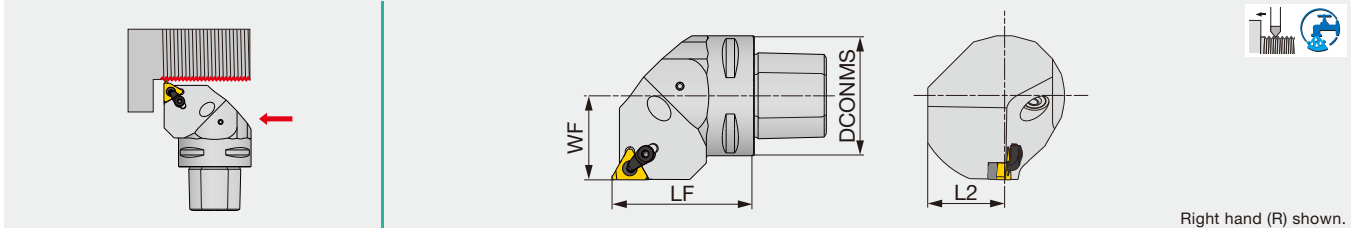

Designation	DCONMS	LF	L2	WF	Insert
C3CER/L22040-16ERN ⁽³⁾	32	40	20	22	16ER/L...
C4CER/L27050-16ERN ⁽³⁾	40	50	25	27	16ER/L...
C5CEL35060-16ER ⁽¹⁾	50	60	32	35	16ER/L...
C5CER/L35060-16ERN ⁽²⁾	50	60	32	35	16ER/L...
C6CEL45065-16ER ⁽¹⁾	63	65	41	45	16ER/L...
C6CER/L45065-16ERN ⁽²⁾	63	65	41	45	16ER/L...

(1) Applicable for 3 MPa coolant (2), (3) Applicable for 7 MPa coolant

Designation	Shim	Shim screw	Clamp screw	Clamping screw	Wrench 1	Wrench 2	Coolant parts
C*CER/L*****-16ER...	A16-1DT	DTS5-3.5	CSTB-3.5ST	CSP16	T-15F	P-3.5	EZ104 ⁽¹⁾
C*CER/L*****-16ER...	A16-1DT	DTS5-3.5	CSTB-3.5ST	CSP16	T-15F	P-3.5	SATZ-M10X1-M5 ⁽²⁾
C*CER/L*****-16ER...	A16-1DT	DTS5-3.5	CSTB-3.5ST	CSP16	T-15F	P-3.5	SATZ-M8X1-M3 ⁽³⁾

(1) Applicable for 3 MPa coolant (2), (3) Applicable for 7 MPa coolant

C-CEL-ERN-B

External threading toolholder, alternative clamping of screw-on or clamp-on

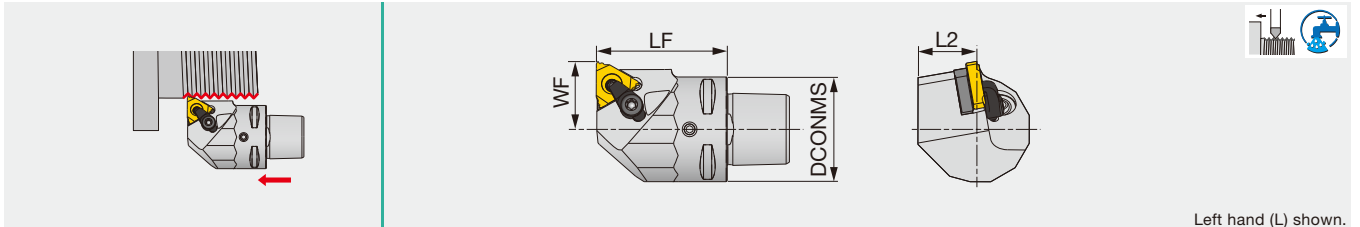

Designation	DCONMS	LF	L2	WF	Insert
C3CEL22040-16ERN-B	32	40	18	22	16ER...

Applicable for 7 MPa coolant
Cannot be used for boring

Designation	Shim	Shim screw	Clamp screw	Clamping screw	Wrench 1	Wrench 2	Coolant parts
C3CEL22040-16ERN-B	A16-1DT	DTS5-3.5	CSTB-3.5ST	CSP16	T-15F	P-3.5	SATZ-M8X1-M3

TUNGCAP

C-CEL-ERB-CHP

External threading toolholder, alternative clamping of screw-on or clamp-on, with high pressure coolant capability

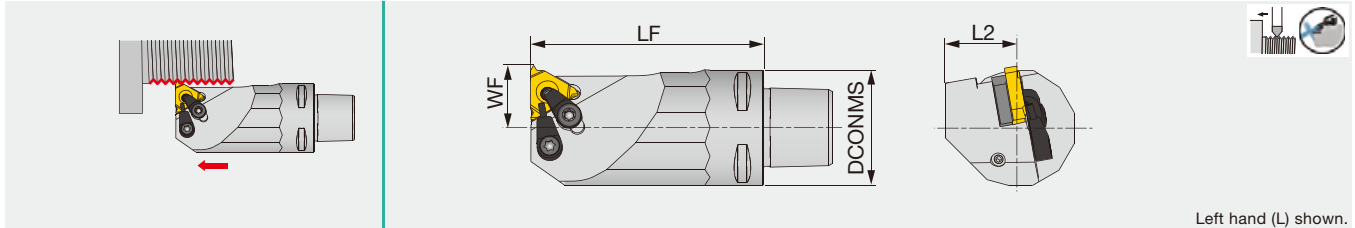

Left hand (L) shown.

Designation	DCONMS	LF	L2	WF	Insert
C3CEL18065-16ERB-CHP	32	65	20	18	16ER...

Applicable for 14 MPa coolant
Cannot be used for boring

SPARE PARTS

Designation	Shim	Shim screw	Clamp screw	Clamping screw	Wrench 1	Wrench 2	Coolant unit
C3CEL18065-16ERB-CHP	A16-1DT	DTS5-3.5	CSTB-3.5ST	CSP16	T-15F	P-3.5	S-CU-CHP

C-STCR/L-18-CHP

External grooving and threading toolholder, with high pressure coolant capability

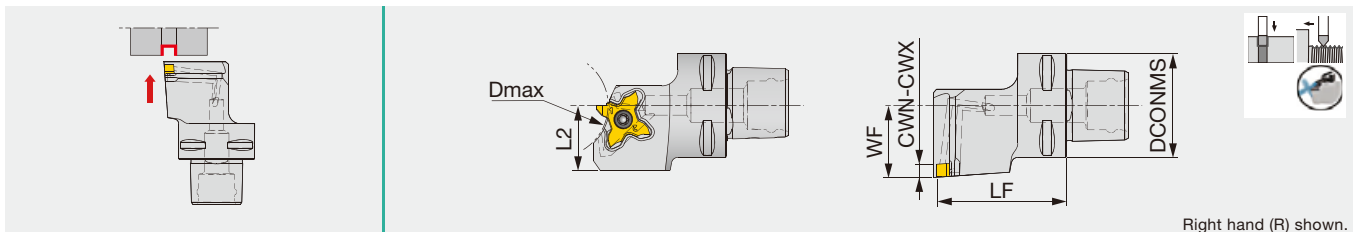

Right hand (R) shown.

Designation	CWN	CWX	DCONMS	LF	L2	WF	Dmax	Insert	Torque*
C3STCR/L22040-18-CHP	0.33	3	32	40	20	22	32	TC*18...	1.2
C4STCR/L27050-18-CHP	0.33	3	40	50	25	27	75 ⁽¹⁾	TC*18...	1.2

Applicable for 14 MPa coolant

Use the right hand insert (TC*18R...) with the right hand holder (STCR...). Use the left hand insert (TC*18L...) with the left hand holder (STCL...).

(1) The value for 3.5 mm groove depth. *Dmax* varies according to the grooving depth required. For further information, see Tungaloy Report #416 TetraMini-Cut/TetraForce-Cut.

*Torque: Recommended clamping torque (N·m)

SPARE PARTS

Designation	Clamping screw	Wrench
C*STCL*-18-CHP	CSTC-4L100DR	T-1008/5
C*STCR*-18-CHP	CSTC-4L100DL	T-1008/5

Reference pages: C-CEL-ERB-CHP: Inserts → **E010 -**
C-STCR/L-18-CHP: Inserts → **F052 -**

C-STCR/L-27-CHP

External grooving toolholder, with high pressure coolant capability

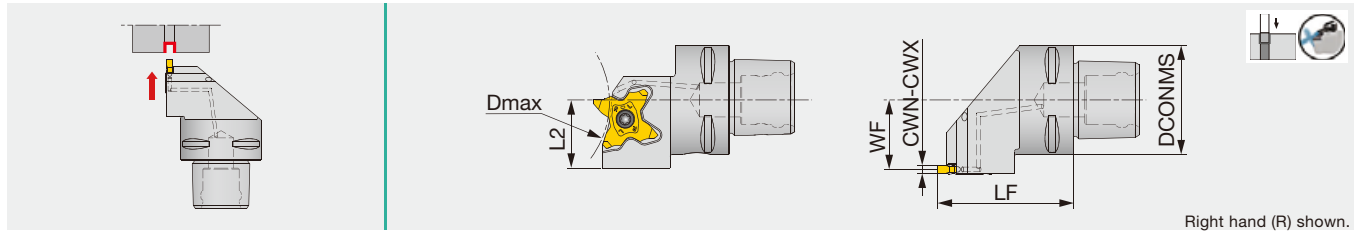

Designation	CWN	CWX	DCONMS	LF	L2	WF	Dmax	Insert	Torque*
C4STCR/L27050-27-CHP	0.5	3.18	40	50	25	25.5	68 ⁽¹⁾	TC*27R/L...	2.5

Applicable for 14 MPa coolant

(1) The value for 6.4 mm groove depth. *Dmax* varies according to the grooving depth required. For further information, see Tungaloy Report #416 TetraMini-Cut/TetraForce-Cut.

*Torque: Recommended clamping torque (N·m)

SPARE PARTS

Designation	Screw	Wrench
C4STCR27050-27-CHP	SR16-212-01397L	T-2010/5
C4STCL27050-27-CHP	SR16-212-01397	T-2010/5

C-STCFL-18-CHP

External grooving and threading toolholder, with high pressure coolant capability

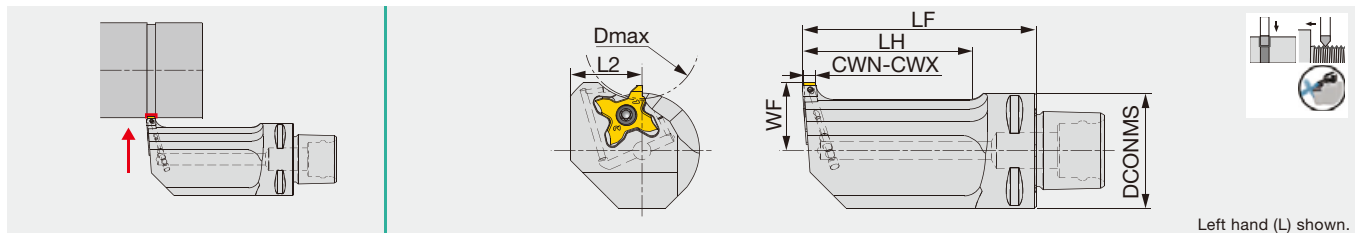

Designation	CWN	CWX	DCONMS	LF	LH	L2	WF	Dmax	Insert	Torque*
C3STCFL18040-18-CHP	0.33	3	32	40	21.5	20	18	32	TC*18R...	1.2
C3STCFL18065-18-CHP	0.33	3	32	65	46.5	20	18	32	TC*18R...	1.2

Applicable for 14 MPa coolant

Use the right hand insert (TC*18R...) with the left hand holder (STCFL...).

*Torque: Recommended clamping torque (N·m)

SPARE PARTS

Designation	Clamping screw	Wrench
C3STCFL*-18-CHP	CSTC-4L100DL	T-1008/5

Reference pages: C-STCR/L-27-CHP: Inserts → **F066** -
C-STCFL-18-CHP: Inserts → **F052** -

Toolholder for CAER/L and CAFR/L adapters

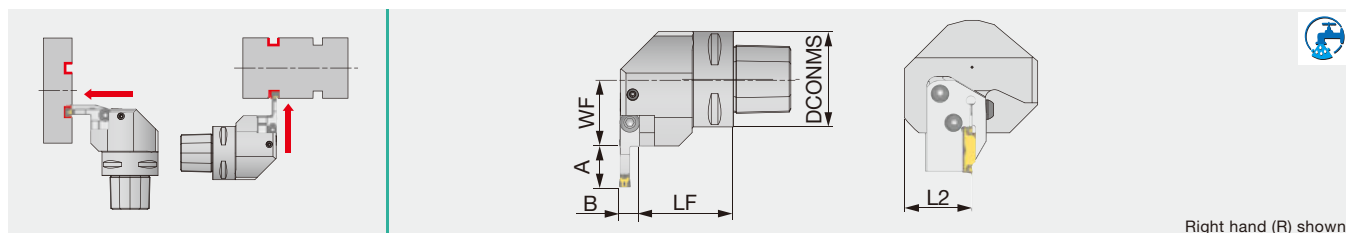

Right hand (R) shown.

Designation	DCONMS	LF	L2	WF	A	B
C3CHFVR/L22040N	32	32.5	35	22	*Table:	*Table:
C4CHFVR/L27050N	40	42.5	36	27	*Table:	*Table:
C5CHFVR/L35060N	50	49.5	36	35	*Table:	*Table:
C6CHFVR/L45065N	63	54.5	41	45	*Table:	*Table:

Applicable for 7 MPa coolant

Depend on the adapter type, the value of A or B may change. If needed, the coolant direction can be adjusted by the nozzle. See the table below for the offset dimensions.

SPARE PARTS

Designation	Coolant parts1	Coolant parts2	Clamping screw	Wrench
C5CHFV*35060N	SATZ-M10X1-M5	-	CSHB-6-A	P-4
C6CHFV*45065	CNZ125	PNZ5	CSHB-6-A	P-4
C6CHFV*45065N	SATZ-M10X1-M5	-	CSHB-6-A	P-4

Combination of adapter and toolholder

Toolholder	Adapter			
	CAER...	CAEL...	CAFR...	CAFL...
C*CHFVR...	-	●	●	-
C*CHFVL...	●	-	-	●

●: Corresponding

C-CHSR/L

Toolholder for CAER/L and CAFR/L adapters

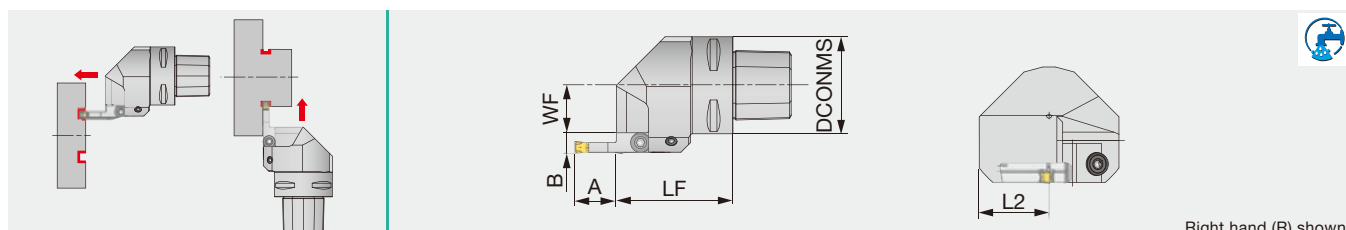

Right hand (R) shown.

Designation	DCONMS	LF	L2	WF	A	B
C3CHSR/L22050N	32	50	35	11.5	*Table:	*Table:
C4CHSR/L27050N	40	50	36	16.5	*Table:	*Table:
C5CHSR/L35060N	50	60	36	24.5	*Table:	*Table:
C6CHSR/L45065N	63	65	41	34.5	*Table:	*Table:

Applicable for 7 MPa coolant

Depend on the adapter type, the value of A or B may change. If needed, the coolant direction can be adjusted by the nozzle. See the table below for the offset dimensions.

SPARE PARTS

Designation	Coolant parts1	Coolant parts2	Clamping screw	Wrench
C4CHS*27050N	SATZ-M8X1-M3	-	CSHB-6-A	P-4
C5CHS*35060	CNZ125	PNZ5	CSHB-6-A	P-4
C*CHS**506*N	SATZ-M10X1-M5	-	CSHB-6-A	P-4

Combination of adapter and toolholder

Toolholder	Adapter			
	CAER...	CAEL...	CAFR...	CAFL...
C*CHSR...	●	-	-	●
C*CHSL...	-	●	●	-

●: Corresponding

*Table: Off set dimensions for adapter

Application	Adapter	A	B
For external grooving	CAER/L-3T16	16	10.4
	CAER/L-4T16	16	10.5
	CAER/L-5T20	20	10.5
	CAER/L-6T20	20	10.5
For face grooving	CAFR/L-3T12-*	12	10.4
	CAFR/L-4T16-*	16	10.5
	CAFR/L-5T20-*	20	10.5
	CAFR/L-6T20-*	25	10.5

CAER/L

Adapter for external grooving and turning

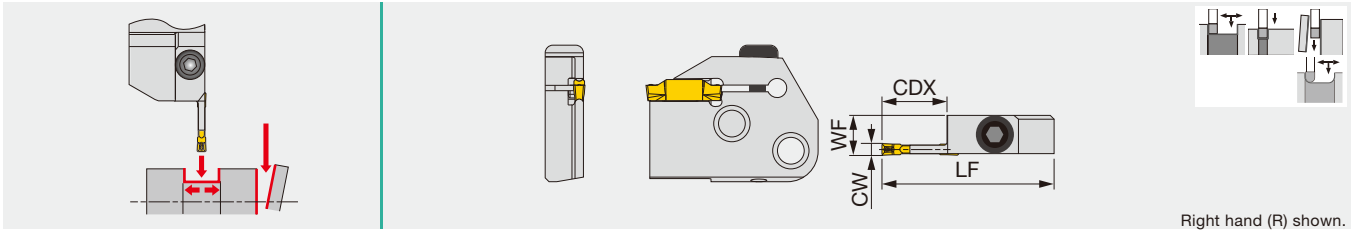

Right hand (R) shown.

Designation	CW	Seat size	CDX	LF	WF	Toolholder
CAER/L-3T16	3	3	16	45	10.4	C*CHSR/L, C*CHFVL/R
CAER/L-4T16	4	4	16	45	10.5	C*CHSR/L, C*CHFVL/R
CAER/L-5T20	5	5	20	49	10.5	C*CHSR/L, C*CHFVL/R
CAER/L-6T20	6	6	20	49	10.5	C*CHSR/L, C*CHFVL/R

SPARE PARTS

Designation	Clamping screw	Wrench
CAER/L...	BHM6-20-A	P-4

CAFR/L

Adapter for face grooving and turning

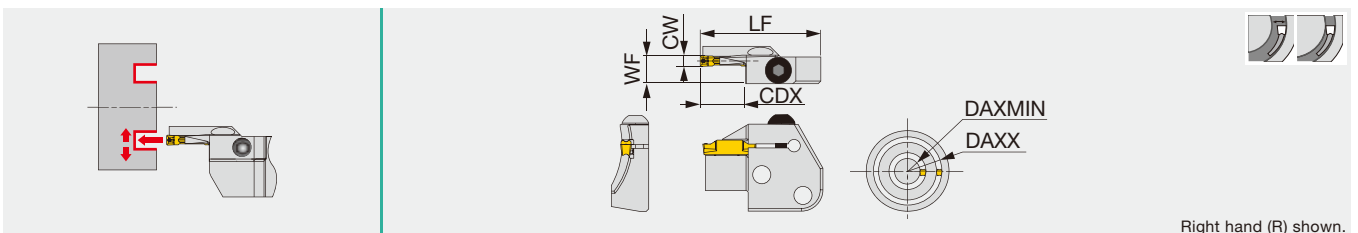

Right hand (R) shown.

Designation	CW	DAXMIN	DAXX	Seat size	CDX	LF	WF ⁽¹⁾
CAFR/L-3T12-040055	3	40	55	3	12	45	10.4
CAFR/L-3T12-055075	3	55	75	3	12	45	10.4
CAFR/L-3T12-075100	3	75	100	3	12	45	10.4
CAFR/L-3T12-100140	3	100	140	3	12	45	10.4
CAFR/L-3T12-140200	3	140	200	3	12	45	10.4
CAFR/L-4T16-050070	4	50	70	4	16	45	10.5
CAFR/L-4T16-070100	4	70	100	4	16	45	10.5
CAFR/L-4T16-100150	4	100	150	4	16	45	10.5
CAFR/L-4T16-150250	4	150	250	4	16	45	10.5
CAFR/L-5T20-055080	5	55	80	5	20	49	10.5
CAFR/L-5T20-080120	5	80	120	5	20	49	10.5
CAFR/L-5T20-120180	5	120	180	5	20	49	10.5
CAFR/L-5T20-180300	5	180	300	5	20	49	10.5
CAFR/L-5T20-300000	5	300	∞	5	20	49	10.5
CAFR/L-6T25-060090	6	60	90	6	25	55	10.5
CAFR/L-6T25-090150	6	90	150	6	25	55	10.5
CAFR/L-6T25-150250	6	150	250	6	25	55	10.5
CAFR/L-6T25-250400	6	250	400	6	25	55	10.5

When groove depth is larger than (insert length - 1.5 mm), please use 1-cornered insert.

(1) WF is calculated with the groove width CW in the above table.

(2) Not applicable to CAFR/L-3T12-040055

(3) Seat sizes of DTF are only 3 and 4.

SPARE PARTS

Designation	Clamping screw	Wrench
CAFR/L...	BHM6-20-A	P-4

Minimum machining diameter in face grooving with each insert

Insert	DAXMIN	Note
DTE 3 / DGS 3 / DGM 3	ø92	When the machining diameter is smaller than DAXMIN, please use DTF or DTX.
DTE 4 / DGS 4 / DGM 4	ø42	
DTE 5 / DGS 5 / DGM 5	ø64	
DTE 6 / DGS 6 / DGM 6	ø61	

Reference pages: CAFR/L: Inserts → **F037** -

Toolholder for adapter with high pressure coolant capability

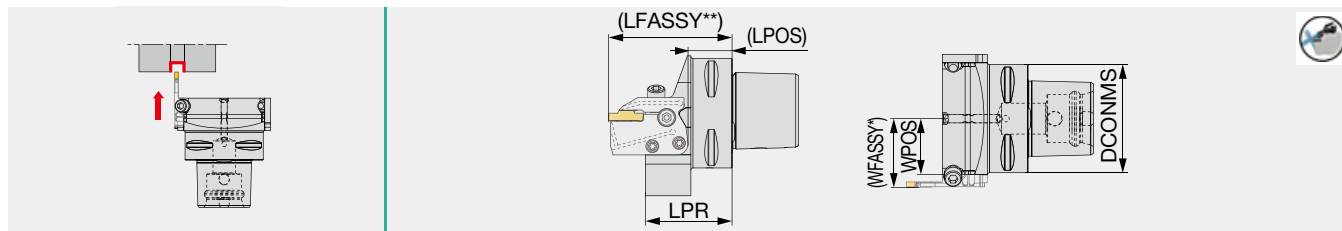

Designation	DCONMS	LPR	LPOSS	WPOS	Adapter (Option)	Torque*
C3CHSN19045-CHP	32	45	17.5	18.5	CAER/L...-CHP	6.5
C4CHSN21047-CHP	40	46.5	21.5	21	CAER/L...-CHP	6.5
C5CHSN26047-CHP	50	47	22.5	26	CAER/L...-CHP	6.5
C6CHSN33050-CHP	63	50	24.5	32.5	CAER/L...-CHP	6.5

When groove depth is larger than (insert length - 1.5 mm), please use 1-cornered insert

WFASSY*: Toolholder (WPOS) + adapter (WF) LFASSY**: Toolholder (LPOSS) + adapter (LF) Torque*: Recommended clamping torque (N-m)

Applicable for 30 MPa coolant

Please see page L053 for the instruction on installing and removing the adapter or the insert.

SPARE PARTS

Designation	Clamping screw1	Clamping screw2	Clamping screw3	Wrench 1	Wrench 2	O-ring
C*CHSN...-CHP	SR M5-04451	SR M6X12DIN6912	SR M6X20-XT	T-20/5	HW5.0	OR 5X1N

C-CHFVN-CHP

Toolholder for adapter with high pressure coolant capability

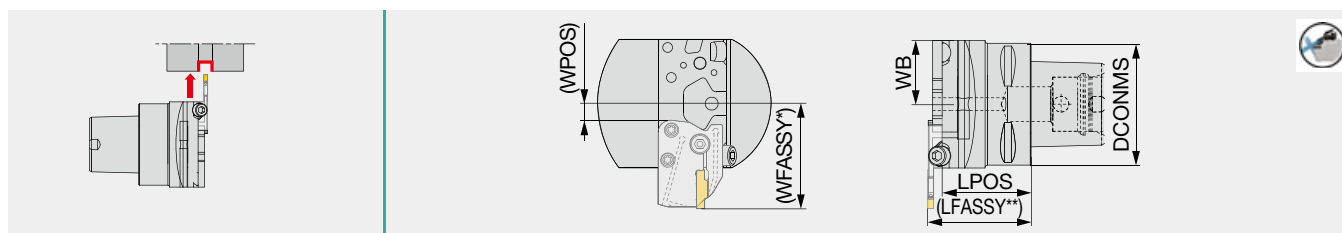

Designation	DCONMS	LPOSS	WB	WPOS	Adapter (Option)	Torque*
C3CHFVN26040-CHP	32	40	26	1.5	CAER/L...-CHP	6.5
C4CHFVN26046-CHP	40	46	26	1.5	CAER/L...-CHP	6.5
C5CHFVN26046-CHP	50	46	26	1.5	CAER/L...-CHP	6.5
C6CHFVN33046-CHP	63	46	33	8.5	CAER/L...-CHP	6.5

When groove depth is larger than (insert length - 1.5 mm), please use 1-cornered insert

WFASSY*: Toolholder (WPOS) + adapter (LF) LFASSY**: Toolholder (LPOSS) + adapter (WF) Torque*: Recommended clamping torque (N-m)

Applicable for 30 MPa coolant

Please see page L053 for the instruction on installing and removing the adapter or the insert.

SPARE PARTS

Designation	Clamping screw1	Clamping screw2	Clamping screw3	Wrench 1	Wrench 2	O-ring
C*CHFVN...-CHP	SR M5-04451	SR M6X12DIN6912	SR M6X20-XT	T-20/5	HW5.0	OR 5X1N

STCAR/L18-CHP

Modular-type external grooving and parting adapter, with high pressure coolant capability

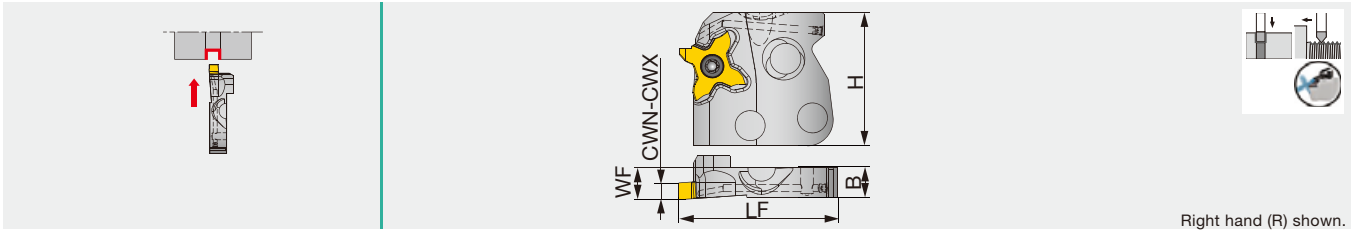

Designation	CWN	CWX	WF	H	LF	B	Insert	Torque*
STCAR/L18-CHP	0.33	3	7.5	33	38	7.2	TC*18...	1.2

Use the right hand insert (TC*18R...) with the right hand adapter (STCAR...). Use the left hand insert (TC*18L...) with the left hand adapter (STCAL...).
*Torque: Recommended clamping torque (N·m)

SPARE PARTS

Designation	Clamping screw	Wrench
STCAL18-CHP	CSTC-4L100DR	T-1008/5
STCAR18-CHP	CSTC-4L100DL	T-1008/5

STCAR/L27-CHP

Modular-type external grooving and parting adapter, with high pressure coolant capability

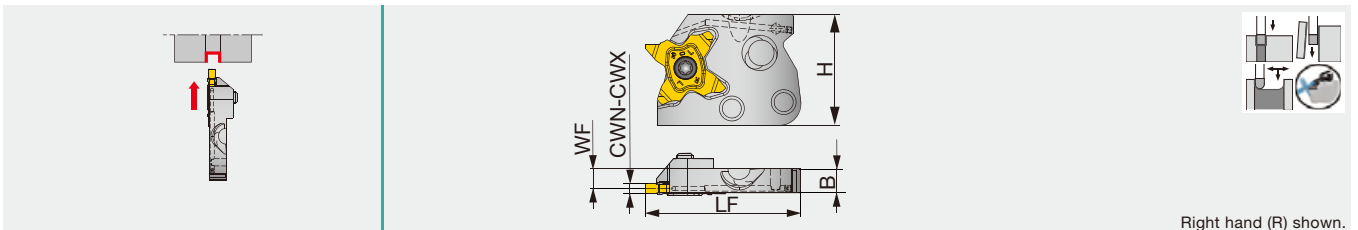

Designation	CWN	CWX	WF	H	LF	B	Insert	Torque*
STCAR/L27-CHP	0.5	3.18	6	33	46	7.2	TC*27...	2.5

*Torque: Recommended clamping torque (N·m)

SPARE PARTS

Designation	Screw	Wrench
STCAR27-CHP	SR16-212-01397L	T-2010/5
STCAL27-CHP	SR16-212-01397	T-2010/5

CAER/L-CHP

Modular-type external grooving and parting adapter, with high pressure coolant capability

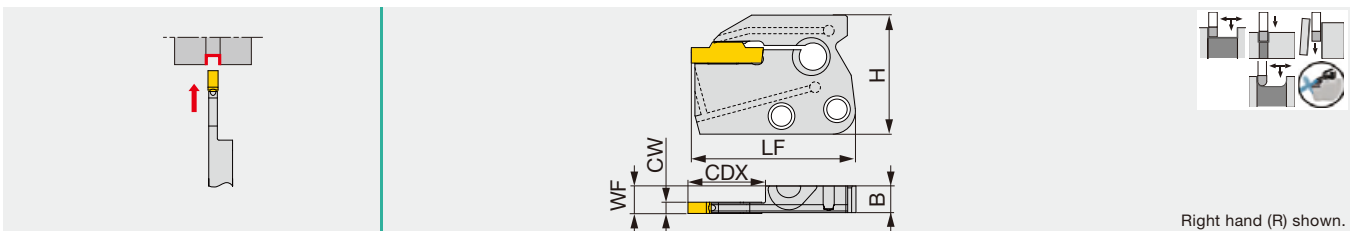

Designation	CW	Seat size	CDX	WF ⁽¹⁾	H	LF	B
CAER/L-2T16-CHP	2	2	16	7.3	33	41.5	7.2
CAER/L-2T20-CHP	2	2	20	7.3	33	45.5	7.2
CAER/L-3T16-CHP	3	3	16	7.4	33	41.5	7.2
CAER/L-3T20-CHP	3	3	20	7.5	33	45.5	7.2
CAER/L-4T16-CHP	4	4	16	7.7	33	41.5	7.2
CAER/L-4T20-CHP	4	4	20	7.7	33	45.5	7.2
CAER/L-5T20-CHP	5	5	20	7.8	33	46.3	7.2
CAER/L-6T20-CHP	6	6	20	7.8	33	46.3	7.2
CAER/L-8T25-CHP	8	8	25	8.3	33	51.1	7.2

When groove depth is larger than (insert length - 1.5 mm), please use 1-cornered insert
(1) "WF" value is calculated with groove width "CW" shown in the table.

Reference pages: STCAR/L18-CHP: Inserts → **F052 -**, STCAR/L27-CHP: Inserts → **F066 -**
CAER/L-CHP: Inserts → **F028 -**

Adapter for parting blades

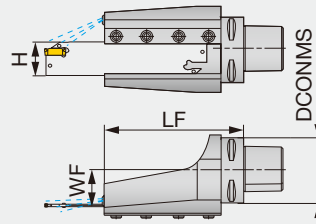

Designation	DCONMS	WF	LF	H
C6TBK-32R/L	63	32	138	32

Applicable for 3 MPa coolant

C-TDX

Indexable drill L/D=3

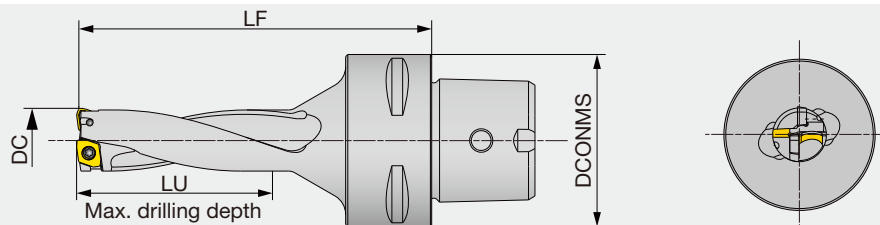

Designation	DC	DCONMS	LF	LU	Max. offset (radial)	Insert
C4TDX150L082-3	15	40	82	45.5	0.9	XPMT050204R-D*
C4TDX200L101-3	20	40	101	60.5	0.5	XPMT06X308R-D*
C4TDX250L125-3	25	40	125	75.6	0.4	XPMT07H308R-D*
C4TDX300L139-3	30	40	139	90.7	0.7	XPMT08T308R-D*
C6TDX200L101-3	20	63	101	60.5	0.5	XPMT06X308R-D*
C6TDX250L121-3	25	63	121	75.6	0.4	XPMT07H308R-D*
C6TDX300L139-3	30	63	139	90.7	0.7	XPMT08T308R-D*
C6TDX350L159-3	35	63	159	106.1	1.8	XPMT110412R-D*
C6TDX400L177-3	40	63	177	121.1	0.5	XPMT110412R-D*

Applicable for 14 MPa coolant

SPARE PARTS



Designation	Clamping screw	Wrench
C4TDX150L082-3	CSTB-2L040	T-6D
C4TDX200L101-3	CSTB-2.2R	T-7D
C4TDX250L125-3	CSTB-2.5	T-8D
C4TDX300L139-3	CSTB-3	T-9D
C6TDX200L101-3	CSTB-2.2R	T-7D
C6TDX250L121-3	CSTB-2.5	T-8D
C6TDX300L139-3	CSTB-3	T-9D
C6TDX350L159-3	CSTB-4	T-15D
C6TDX400L177-3	CSTB-4	T-15D

Reference pages: C-TDX: Inserts → **J076**

C-EPA

Square shoulder milling

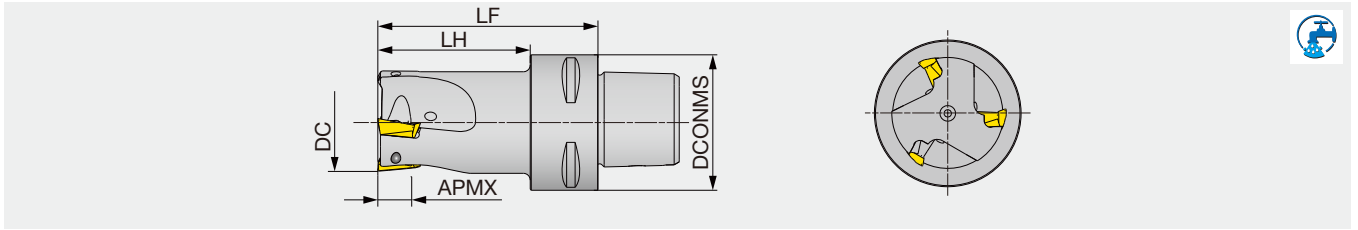

Designation	DC	APMX	DCONMS	CICT	LF	LH	Air hole	Insert
C4EPA10M032R03L065	32	10	40	3	65	45	with	TOMT1004...
C4EPA10M035R03L065	35	10	40	3	65	45	with	TOMT1004...
C6EPA15M040R03L080	40	15	63	3	80	58	with	TOMT1506...
C6EPA15M050R04L080	50	15	63	4	80	58	with	TOMT1506...

Applicable for 14 MPa coolant

SPARE PARTS

Designation	Clamping screw	Torx bit	Grip
C4EPA10M0**R03L065	SR14-562/S	BLDT10/S7	SW6-SD
C6EPA15M0**R0L080	TS45120I	BT20S	H-TB2W

C-TLA

Square shoulder milling (for large depth of cut)

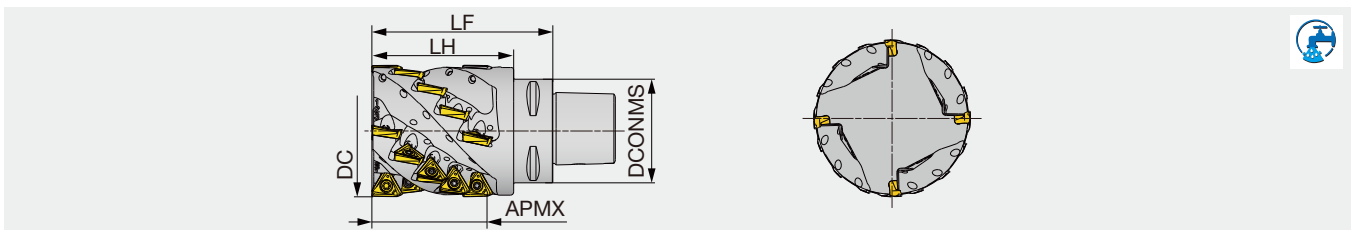

Designation	DC	APMX	DCONMS	CICT	ZEPF	LF	LH	Air hole	Insert
C6TLA15M063R03L100	63	55	63	12	3	100	78	with	TOMT1506...
C6TLA15M080R04L110	80	70	63	20	4	110	86.2	with	TOMT1506...

Applicable for 14 MPa coolant

SPARE PARTS

Designation	Clamping screw	Torx bit	Grip
C6TLA15M0**R0L1**	TS45120I	BT20S	H-TB2W

Reference pages: C-EPA, C-TLA: Inserts → **H136**

Side-lock holder for weldon endmills (DIN1835 Form B)

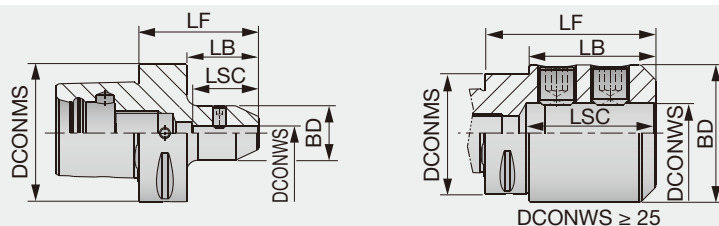

Designation	DCONMS	DCONWS	BD	LF	LB	LSC	Designation	DCONMS	DCONWS	BD	LF	LB	LSC
C3EM6X45	32	6	25	45	30	29	C6EM10X60	63	10	35	60	38	39
C3EM8X45	32	8	28	45	25	35	C6EM12X60	63	12	42	60	38	43
C3EM10X50	32	10	35	50	30	39	C6EM14X60	63	14	44	60	38	43
C3EM12X55	32	12	42	55	35	43	C6EM16X65	63	16	48	65	43	47
C4EM06X50	40	6	25	50	30	29	C6EM18X65	63	18	50	65	43	47
C4EM08X50	40	8	28	50	30	35	C6EM20X65	63	20	52	65	43	49
C4EM10X50	40	10	35	50	30	39	C6EM25X80	63	25	65	80	58	68
C4EM12X55	40	12	42	55	35	43	C6EM32X90	63	32	72	90	68	68
C4EM14X55	40	14	44	55	35	43	C6EM40X100	63	40	90	100	78	78
C4EM16X60	40	16	48	60	40	47	C8EM06X70	80	6	25	70	40	30
C5EM06X50	50	6	25	50	30	29	C8EM08X70	80	8	28	70	40	35
C5EM08X50	50	8	28	50	30	35	C8EM10X70	80	10	35	70	40	39
C5EM10X55	50	10	35	55	35	39	C8EM12X70	80	12	42	70	40	43
C5EM12X60	50	12	42	60	40	43	C8EM14X70	80	14	44	70	40	43
C5EM14X60	50	14	44	60	40	43	C8EM16X70	80	16	48	70	40	47
C5EM16X60	50	16	48	60	40	47	C8EM18X70	80	18	50	70	40	47
C5EM18X60	50	18	50	60	40	47	C8EM20X70	80	20	52	70	40	49
C5EM20X60	50	20	52	60	40	49	C8EM25X90	80	25	65	90	60	68
C5EM25X85	50	25	65	85	65	64	C8EM32X95	80	32	72	95	65	68
C6EM6X55	63	6	25	55	33	29	C8EM40X110	80	40	90	110	80	68
C6EM8X55	63	8	28	55	33	35	C8EM50X120	80	50	98	120	90	90

Applicable for 7 MPa coolant

Side lock

Collet chuck

Face mill

Milling chuck

Hydro chuck

Shrinking chuck

Others

C-EM-E

Side-lock holder for drills (DIN1835 Form E whistle notch)

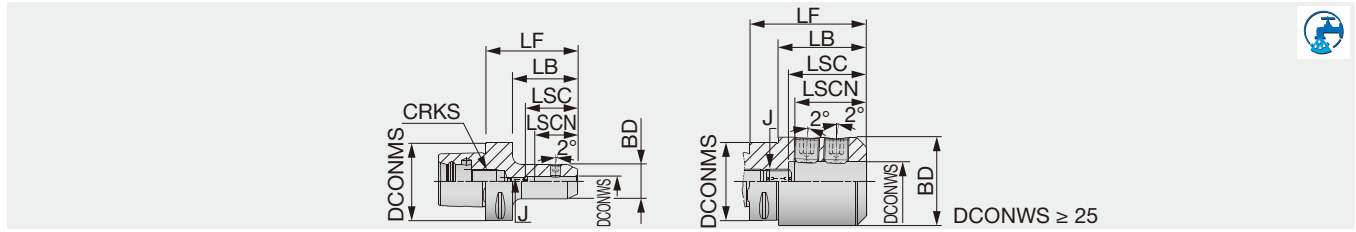

Designation	DCONMS	DCONWS	BD	LF	LSCN	LSC	LB	J	CRKS
C3EM06X70E	32	6	25	70	30	35	50	5	M14
C3EM12X75E	32	12	42	75	44	49	55	10	M14
C4EM06X70E	40	6	25	70	30	35	50	M5	M14
C4EM08X70E	40	8	28	70	35	43	50	M6	M14
C4EM10X70E	40	10	35	70	39	45	50	M8	M14
C4EM12X75E	40	12	42	75	44	49	55	M10	M14
C4EM14X75E	40	14	44	75	44	49	55	M10	M14
C5EM10X70E	50	10	35	70	39	45	50	M8	M16
C5EM12X75E	50	12	42	75	44	49	55	M10	M16
C5EM14X75E	50	14	44	75	44	49	55	M10	M16
C5EM16X80E	50	16	48	80	47	52	60	M12	M16
C5EM18X80E	50	18	50	80	47	52	60	M12	M16
C5EM20X85E	50	20	52	85	49	55	65	M16	M16
C6EM06X75E	63	6	25	75	30	36	53	M5	M20
C6EM08X75E	63	8	28	75	35	43	53	M6	M20
C6EM10X75E	63	10	35	75	39	46	53	M8	M20
C6EM12X80E	63	12	42	80	44	49	58	M10	M20
C6EM14X80E	63	14	44	80	44	49	58	M10	M20
C6EM16X85E	63	16	48	85	47	52	63	M12	M20
C6EM18X85E	63	18	50	85	47	52	63	M12	M20
C6EM20X85E	63	20	52	85	49	55	63	M16	M20
C6EM25X90E	63	25	65	90	54	60	68	M20	M20
C6EM32X95E	63	32	72	95	58	63	73	M20	M20
C8EM08X65E	80	8	28	65	35	43	35	M6	M20
C8EM10X65E	80	10	35	65	39	46	35	M8	M20
C8EM12X70E	80	12	42	70	44	49	40	M10	M20
C8EM14X70E	80	14	44	70	44	49	40	M10	M20
C8EM16X75E	80	16	48	75	47	52	45	M12	M20
C8EM18X75E	80	18	50	75	47	52	45	M12	M20
C8EM20X80E	80	20	52	80	49	57	50	M16	M20
C8EM25X90E	80	25	65	90	54	60	60	M20	M20
C8EM32X95E	80	32	72	95	58	64	65	M20	M20

Applicable for 7 MPa coolant

Grade
Insert
Ext. Toolholder
Int. Toolholder
Threading
Grooving
Miniature tool
Milling cutter
Endmill
Drilling tool
Tooling System
User's Guide
Index



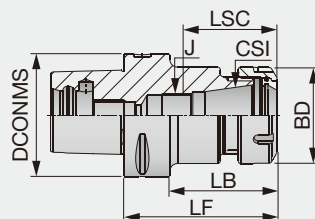

Designation	Range min	Range Max.	DCONMS	CSI	BD	LF	LB	J	LSC	Designation	Range min	Range Max.	DCONMS	CSI	BD	LF	LB	J	LSC	
C3ER16X30T	1	10	32	ER16	30	30	-	-	33	C6ER20X100	1	13	63	ER20	34	100	78	M12	52.5	
C3ER16X45	1	10	32	ER16	28	45	25	-	39	C6ER20X130	1	13	63	ER20	34	130	108	M12	52.5	
C3ER20X35T	1	13	32	ER20	36	35	-	-	38.5	C6ER20X160	1	13	63	ER20	34	160	138	M12	52.5	
C3ER20X45	1	13	32	ER20	34	45	30	-	39.8	C6ER25X060	1	16	63	ER25	42	60	38	-	40.4	
C4ER16X70	1	10	40	ER16	28	70	50	M10	41.6	C6ER25X100	1	16	63	ER25	42	100	78	M16	65	
C4ER20X35*	1	13	40	ER20	34	35	27	-	39.8	C6ER25X130	1	16	63	ER25	42	130	108	M16	73	
C4ER20X52	1	13	40	ER20	34	52	32	-	39.1	C6ER25X160	1	16	63	ER25	42	160	138	M16	73	
C4ER25X38*	1	16	40	ER25	42	38	30	-	43.3	C6ER32X060	2	20	63	ER32	50	60	36	-	47.8	
C4ER25X52	1	16	40	ER25	42	52	32	-	40.8	C6ER32X100	2	20	63	ER32	50	100	78	M22X1.5	59.4	
C4ER32X54	2	20	40	ER32	50	54	34	-	46.7	C6ER32X130	2	20	63	ER32	50	130	108	M22X1.5	69.4	
C5ER16X100	1	10	50	ER16	28	100	80	M10	61.6	C6ER32X160	2	20	63	ER32	50	160	138	M22X1.5	69.4	
C5ER16X130	1	10	50	ER16	28	130	110	M10	71.6	C6ER40X065	3	26	63	ER40	63	65	37	-	55	
C5ER20X055	1	13	50	ER20	34	55	35	-	39.3	C6ER40X100	3	26	63	ER40	63	100	78	M28X1.5	60	
C5ER20X100	1	13	50	ER20	34	100	80	M12	52.5	C6ER40X130	3	26	63	ER40	63	130	108	M28X1.5	70	
C5ER20X130	1	13	50	ER20	34	130	110	M12	52.5	C8ER32X70	2	20	80	ER32	50	70	40	-	47.8	
C5ER25X055	1	16	50	ER25	42	55	35	-	40.5	C8ER32X100	2	20	80	ER32	50	100	70	M22x1.5	60.4	
C5ER25X100	1	16	50	ER25	42	100	80	M16	65	C8ER32X160	2	20	80	ER32	50	160	130	M22x1.5	65.4	
C5ER32X057	2	20	50	ER32	50	57	36	-	47.2	C8ER40X70	3	26	80	ER40	63	70	40	-	54.8	
C5ER32X100	2	20	50	ER32	50	100	36	M22X1.5	59.4	C8ER40X100	3	26	80	ER40	63	100	70	M28x1.5	60	
C6ER16X100	1	10	63	ER16	28	100	78	M10	61.6	C8ER40X160	3	26	80	ER40	63	160	130	M28x1.5	71	
C6ER16X130	1	10	63	ER16	28	130	108	M10	71.6											
C6ER16X160	1	10	63	ER16	28	160	138	M10	71.6											
C6ER20X060	1	13	63	ER20	34	60	38	-	39.5											

Option: Wrench for ER collet

* Without V grooves, for manual use only.
Applicable for 10 MPa coolant

Side lock

Collet chuck

Face mill

Milling chuck

Hydro chuck

Shrinking chuck

Others

C-ER-M

ER Mini collet chuck holder (DIN6499)

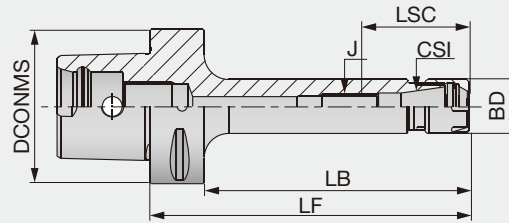

Designation	Range min	Range max	DCONMS	CSI	BD	LF	LB	J	LSC
C4ER16X70M	0.5	10	40	ER16	22	70	50	M10	41
C5ER16X100M	0.5	10	50	ER16	22	100	80	M10	46
C5ER16X130M	0.5	10	50	ER16	22	130	110	M10	46
C6ER16X100M	0.5	10	63	ER16	22	100	78	M10	46
C6ER16X130M	0.5	10	63	ER16	22	130	108	M10	46
C6ER16X160M	0.5	10	63	ER16	22	160	138	M10	46

Applicable for 10 MPa coolant

Option: Wrench for ER collet

ADJ C-ER

ER collet chuck with center alignment

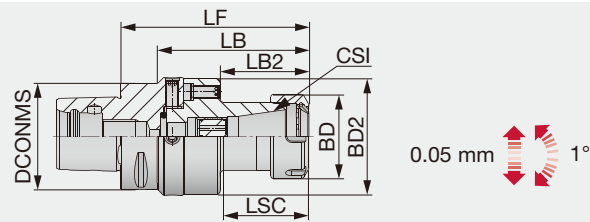

Designation	DCONMS	CSI	Range min	Range max	BD2	BD	LF	LB	LB2	LSC
ADJC5ER32	50	ER32	2	20	70	50	115	95	52.5	57
ADJC6ER32	63	ER32	2	20	70	50	111.5	89.5	52.5	57

Applicable for 10 MPa coolant

Option: Wrench for ER collet

WRENCH-ER / ER DIN 6499

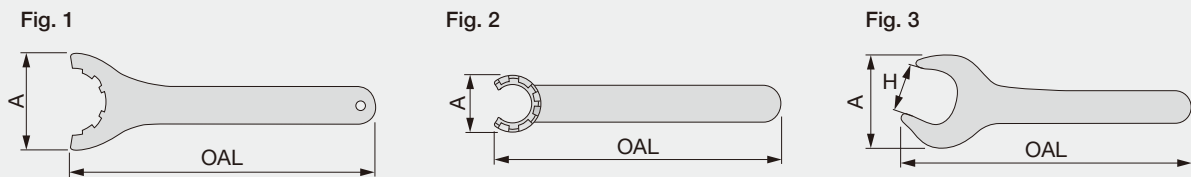

Designation	A	H	OAL	Fig.
WRENCHER11MINI	16.8	-	95	2
WRENCHER11	32	17	95	3
WRENCHER16MINI	22.5	-	117	2
WRENCHER16	42.8	25	143	3
WRENCHER20MINI	28	-	128	2
WRENCHER20	53.5	30	172	3
WRENCHER25MINI	29	-	120	2
WRENCHER25	70	-	207	1
WRENCHER32	78	-	255	1
WRENCHER40	95	-	285	1
WRENCHER50	110	-	350	1
WRENCHER20SHORTRING22	48	22	260	3
WRENCHER32SHORT	75	36	303	3
WRENCHER40SHORT	94	46	378	3

PRESET ER-JET (Preset screw)

Fig. 1

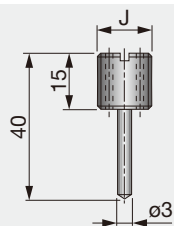
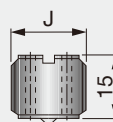

Fig. 2



Designation	J	Fig.
PRESETER-JET8X1	M8X1.0	2
PRESETER-JET8X1.25	M8X1.25	2
PRESETER-JET10X1.5	M10X1.5	2
PRESETER-JET12X1	M12X1.0	2
PRESETER-JET12X1.75L	M12X1.75	1
PRESETER-JET12X1.75	M12X1.75	2
PRESETER-JET14X1	M14X1.0	2
PRESETER-JET16X2	M16X2	2
PRESETER-JET16X2L	M16X2	1
PRESETER-JET18X1	M18X1.0	2
PRESETER-JET18X1.5	M18X1.5	2
PRESETER-JET18X1.5L	M18X1.5	1
PRESETER-JET22X1.5	M22X1.5	2
PRESETER-JET22X1.5L	M22X1.5	1
PRESETER-JET28X1.5	M28X1.5	2

Side lock

Collet chuck

Face mill

Milling chuck

Hydro chuck

Shrinking chuck

Others

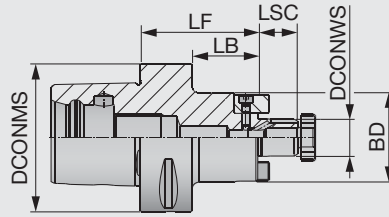

Designation	DCONMS	DCONWS	BD	LF	LSC	LB	Width of key	Height of key	Designation	DCONMS	DCONWS	BD	LF	LSC	LB	Width of key	Height of key
C4SEM16X32C	40	16	38	32	17	12	8	5	C6SEM27X100C	63	27	58	100	21	78	12	6.3
C4SEM16X55C	40	16	38	55	17	35	8	5	C6SEM31.75X60C	63	31.75	64	60	30	-	12.7	6
C4SEM22X40C	40	22	47	40	19	20	10	5.4	C6SEM32X60C	63	32	66	60	24	38	14	7
C4SEM22X55C	40	22	47	55	19	35	10	5.4	C6SEM38.1X60C	63	38.1	78	60	34	-	15.875	8
C5SEM16X35C	50	16	38	35	17	15	8	5	C6SEM40X60C	63	40	82	60	27	38	16	8
C5SEM16X70C	50	16	38	70	17	50	8	5	C8SEM16X50C	80	16	38	50	17	20	8	5
C5SEM22X35C	50	22	47	35	19	15	10	5.4	C8SEM16X100C	80	16	38	100	17	70	8	5
C5SEM22X70C	50	22	47	70	19	50	10	5.4	C8SEM22X50C	80	22	47	50	20	19	10	5.4
C5SEM25.4X37C	50	25.4	55	37	22	-	9.525	4.6	C8SEM22X100C	80	22	47	100	19	70	10	5.4
C5SEM27X40C	50	27	58	40	21	20	12	6.3	C8SEM25.4X50C	80	25.4	50	50	22	20	9.525	4.6
C5SEM31.75X60C	50	31.75	64	60	30	-	12.7	6	C8SEM27X50C	80	27	58	50	21	20	12	6.3
C5SEM32X40C	50	32	63	40	24	20	14	7	C8SEM27X100C	80	27	58	100	21	70	12	6.3
C6SEM16X50C	63	16	38	50	17	28	8	5	C8SEM31.75X50C	80	31.75	60	50	30	20	12.7	7
C6SEM16X100C	63	16	38	100	17	78	8	5	C8SEM32X50C	80	32	66	50	24	20	14	7
C6SEM22X50C	63	22	47	50	19	28	10	5.4	C8SEM32X100C	80	32	66	100	24	70	14	7
C6SEM22X100C	63	22	47	100	19	78	10	5.4	C8SEM38.1X50C	80	38.1	80	50	34	-	15.875	8
C6SEM25.4X37C	63	25.4	55	37	22	15	9.525	4.6	C8SEM40X60C	80	40	82	60	27	30	16	8
C6SEM27X60C	63	27	58	60	21	38	12	6.3									

Option: Wrench for lock screw

Applicable for 7 MPa coolant

WRENCH SEMC / DIN6368

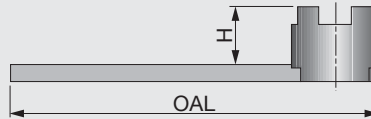

Designation	Inner diameter of cutter body	Screw size	H	OAL
WRENCHM8SEMC16	16	M8	20	180
WRENCHM10SEMC22	22	M10	25	200
WRENCHM12SEMC27	25.4 / 27	M12	32	225
WRENCHM16SEMC32	31.75 / 32	M16	36	250
WRENCHM20SEMC40	38.1 / 40	M20	40	280
WRENCHM24SEMC50	50	M24	50	315

Arbor for face mill

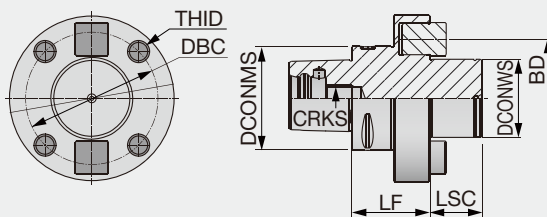

Designation	DCONMS	DCONWS	LSC	LF	BD	DBC	THID	CRKS	Width of key	Height of key
C8FM60X60	80	60	40	60	128	101.6	M16	M20	25.4	12.4

C-ODP

Screw-clamp holder for modular heads

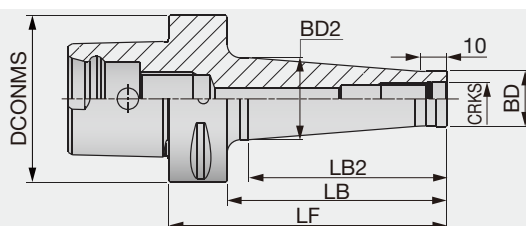

Designation	CRKS	DCONMS	BD	BD2	LF	LB	LB2
C4ODP10X53	M10	40	18	23	53	33	23
C4ODP12X53	M12	40	21	26	53	33	23
C4ODP16X53	M16	40	29	34	53	33	23
C5ODP10X53	M10	50	18	19.5	53	33	25
C5ODP10X103	M10	50	18	28	103	83	75
C5ODP12X53	M12	50	21	23.5	53	33	25
C5ODP12X103	M12	50	21	31	103	83	75
C5ODP16X53	M16	50	29	34	53	33	25
C5ODP16X103	M16	50	29	36	103	83	75
C6ODP10X55	M10	63	18	19.5	55	33	25
C6ODP10X105	M10	63	18	28	105	83	75
C6ODP10X130	M10	63	18	32	130	108	100
C6ODP12X55	M12	63	21	23.5	55	33	25
C6ODP12X105	M12	63	21	31	105	83	75
C6ODP12X130	M12	63	21	36	130	108	100
C6ODP16X55	M16	63	29	34	55	33	25
C6ODP16X105	M16	63	29	34	105	83	75
C6ODP16X130	M16	63	29	41	130	108	100

Applicable for 10 MPa coolant



C-TUNGMAX

Power chuck holder

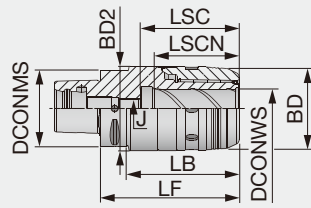

Designation	DCONMS	Range	DCONWS	BD	BD2	LF	LB	LSCN	LSC	J
C5MAXIN20X100	50	6-20	20	51	53	95.5	75	55	67	M16
C6MAXIN20X95	63	6-20	20	51	53	95	73	55	67	M16
C6MAXIN32X115	63	6-32	32	69	70	115	93	70	82	M16
C8MAXIN20X95	80	6-20	20	51	53	95	65	55	67	M16
C8MAXIN32X115	80	6-32	32	69	70	115	85	70	82	M16

Applicable for 10 MPa coolant

Option : Wrench for TungMax collet

SC-SEAL

SC sealed straight collet

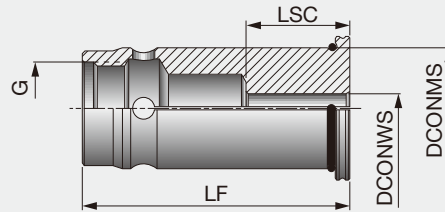

Designation	DCONWS	DCONMS	LF	LSC	G
SC20SEAL6	6	20	60	28	M16
SC20SEAL8	8	20	60	28	M16
SC20SEAL10	10	20	60	35	M16
SC20SEAL12	12	20	60	40	M16
SC20SEAL14	14	20	60	40	M16
SC20SEAL15	15	20	60	40	M16
SC20SEAL16	16	20	60	39	M16
SC32SEAL6	6	32	72	28	M24x1.5
SC32SEAL8	8	32	72	28	M24x1.5
SC32SEAL10	10	32	72	35	M24x1.5
SC32SEAL12	12	32	72	40	M24x1.5
SC32SEAL14	14	32	72	40	M24x1.5
SC32SEAL15	15	32	72	40	M24x1.5
SC32SEAL16	16	32	72	44	M24x1.5
SC32SEAL18	18	32	72	44	M24x1.5
SC32SEAL19	19	32	72	44	M24x1.5
SC32SEAL20	20	32	72	46	M24x1.5
SC32SEAL24	24	32	72	46	M24x1.5
SC32SEAL25	25	32	72	51	M24x1.5

Applicable for 10 MPa coolant

Grade
Insert
Ext. Toolholder
Int. Toolholder
Threading
Grooving
Miniature tool
Milling cutter
Endmill
Drilling tool
Tooling System
User's Guide
Index

A
B
C
D
E
F
G
H
I
J
K
L
M

SC-SPR

SC straight collet

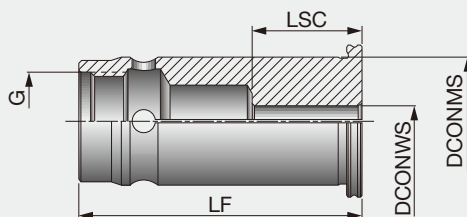

Designation	DCONWS	DCONMS	LF	LSC	G
SC20SPR6	6	20	60	28	M16
SC20SPR8	8	20	60	28	M16
SC20SPR10	10	20	60	35	M16
SC20SPR12	12	20	60	40	M16
SC20SPR14	14	20	60	40	M16
SC20SPR15	15	20	60	40	M16
SC20SPR16	16	20	60	39	M16
SC32SPR6	6	32	72	28	M24x1.5
SC32SPR8	8	32	72	28	M24x1.5
SC32SPR10	10	32	72	35	M24x1.5
SC32SPR12	12	32	72	40	M24x1.5
SC32SPR14	14	32	72	40	M24x1.5
SC32SPR15	15	32	72	40	M24x1.5
SC32SPR16	16	32	72	44	M24x1.5
SC32SPR18	18	32	72	44	M24x1.5
SC32SPR19	19	32	72	44	M24x1.5
SC32SPR20	20	32	72	46	M24x1.5
SC32SPR24	84	32	72	45	M24x1.5
SC32SPR25	25	32	72	51	M24x1.5

PRESET SC CAP

Preset screw for SC collets

Fig. 1

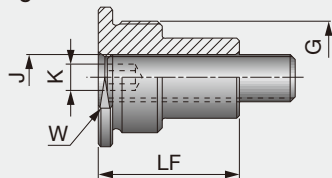
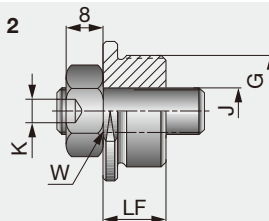
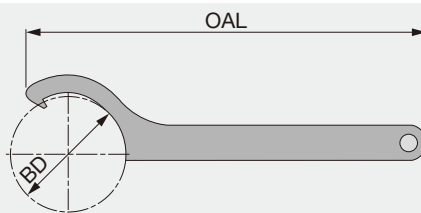

Fig. 2



Designation	LF	W	J	G	Range	Key	Collet size	Fig.
PRESETSCCAP8X1.25L	28	16	M8x25	M16	6-8	4	SC20	1
PRESETSCCAP8X1.25	15	16	M8x25	M16	10-16	4	SC20	2
PRESETSCCAP10X1.5L	30	27	M10x30	M24x1.5	6-14	5	SC32	1
PRESETSCCAP10X1.5	13.5	27	M10x30	M24x1.5	16-25	5	SC32	2

Wrench



Designation	BD	OAL
WRENCHMAXIN20HOOK	26	205
WRENCHMAXIN32HOOK	68	240

SC collet extracting hook

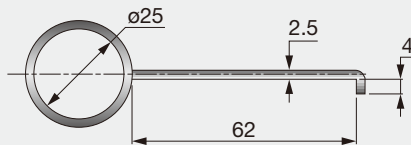

Designation

EXTRACTORSCCOLLETS

Preset screw

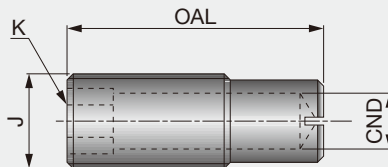

Designation	J	OAL	CND	K
PRESETMAXIN16X30	M16	30	8	8
PRESETMAXIN16X44	M16	44	8	8
PRESETMAXIN20X55	M20	55	12	12

TUNGCAP C-SRKIN

Shrink holder

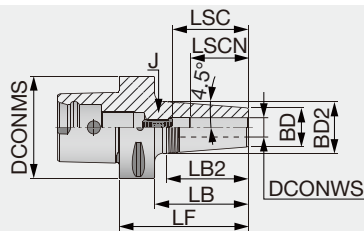

Designation	DCONMS	DCONWS	BD	BD2	LF	LB	LB2	LSCN	LSC	J
C4SRKIN6X75	40	6	21	27	75	55	38.1	25	36	M5
C4SRKIN8X75	40	8	21	27	75	55	38.1	25	36	M6
C4SRKIN10X75	40	10	24	32	75	55	50.8	31	42	M8
C4SRKIN12X75	40	12	24	32	75	55	50.8	36	47	M10
C4SRKIN14X80	40	14	27	34	80	60	44.5	36	47	M10
C4SRKIN16X80	40	16	27	34	80	60	44.5	39	50	M12
C4SRKIN18X80	40	18	33	42	80	60	57.2	39	50	M12
C4SRKIN20X85	40	20	33	42	85	65	57.2	41	52	M16
C5SRKIN6X75	50	6	21	27	75	55	38.1	25	36	M5
C5SRKIN8X75	50	8	21	27	75	55	38.1	25	36	M6
C5SRKIN10X75	50	10	24	32	75	55	51.3	31	42	M8
C5SRKIN12X75	50	12	24	32	75	55	51.3	36	47	M10
C5SRKIN14X80	50	14	27	34	80	60	44.5	36	47	M10
C5SRKIN16X80	50	16	27	34	80	60	44.5	39	50	M12
C5SRKIN18X80	50	18	33	42	80	60	57.2	39	50	M12
C5SRKIN20X85	50	20	33	42	85	65	57.2	41	52	M16
C5SRKIN25X90	50	25	44	53	90	70	57.2	47	58	M16
C6SRKIN6X80	63	6	21	27	80	58	38.1	25	36	M5
C6SRKIN8X80	63	8	21	27	80	58	38.1	25	36	M6
C6SRKIN10X80	63	10	24	32	80	58	50.8	31	42	M8
C6SRKIN12X80	63	12	24	32	80	58	50.8	36	47	M10
C6SRKIN14X85	63	14	27	34	85	63	44.5	36	47	M10
C6SRKIN16X85	63	16	27	34	85	63	44.5	39	50	M12
C6SRKIN18X85	63	18	33	42	85	63	57.2	39	50	M12
C6SRKIN20X85	63	20	33	42	85	63	57.2	41	52	M16
C6SRKIN25X90	63	25	44	53	90	68	57.2	47	58	M16
C6SRKIN32X95	63	32	44	53	95	73	57.2	47	58	M16

Applicable for 10 MPa coolant

Slot milling holder

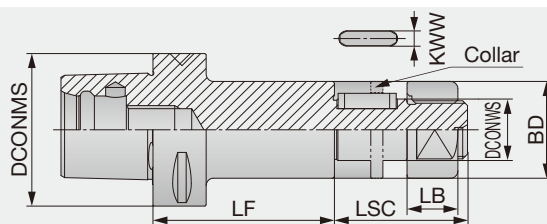

Designation	DCONMS	DCONWS	LF	BD	LSC	LB	Width of key KWM	Height of key
C6SCA25.4-075	63	25.4	75	40	55	21	6.35	2.38
C6SCA31.75-075	63	31.75	75	46	60	26	7.92	3.17
C8SCA25.4-090	80	25.4	90	40	55	21	6.35	2.38
C8SCA31.75-090	80	31.75	90	46	60	26	7.92	3.17

Collars for slot mills are not included

SCA

Collar for slot milling holders

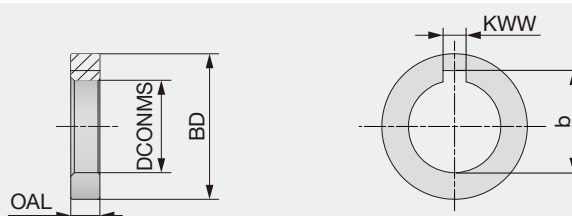

Designation	BD	DCONMS	b	KWW	OAL
SCA25.4-02	40	25.4	28.1	6.35	3, 5, 7, 8, 10, 12, 14
SCA31.75-02	46	31.75	35.2	7.92	3, 5, 7, 8, 10, 12, 14

BT-FC

Basic holder for BT shank with dual contact

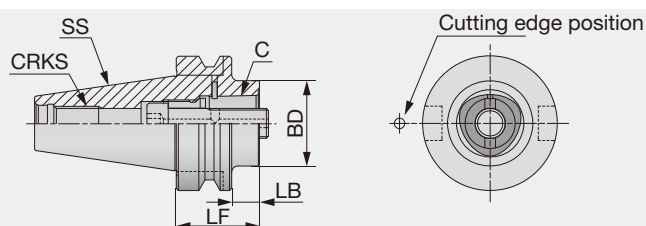

Designation	C	SS	BD	LF	LB	CRKS	Nm ⁽¹⁾	Wrench size
BT40FC-C4-040	C4	40	40	40	13	M16	55	8
BT40FC-C5-050	C5	40	50	50	23	M16	95	10
BT40FC-C6-075	C6	40	63	75	48	M16	170	10
BT50FC-C4-040	C4	50	40	40	2	M24	55	8
BT50FC-C4-070	C4	50	40	70	32	M24	55	8
BT50FC-C5-040	C5	50	50	40	2	M24	95	10
BT50FC-C5-080	C5	50	50	80	42	M24	95	10
BT50FC-C6-050	C6	50	63	50	12	M24	170	14
BT50FC-C6-100	C6	50	63	100	62	M24	170	14
BT50FC-C8-070	C8	50	80	70	32	M24	170	14
BT50FC-C8-120	C8	50	80	120	82	M24	170	14

Applicable for 7 MPa coolant

(1) Recommended clamping torque (N·m)



BT-FC-T

Basic holder for BT shank with dual contact (for turning on multi task machines)

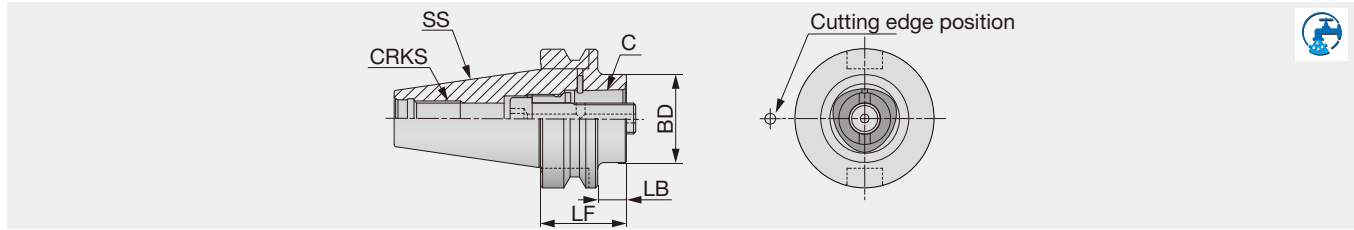

Designation	C	SS	BD	LF	LB	CRKS	Nm ⁽¹⁾	Wrench size
BT40FC-C4-040T	C4	40	40	40	13	M16	55	8
BT40FC-C5-050T	C5	40	50	50	23	M16	95	10
BT50FC-C6-050T	C6	50	63	50	12	M24	170	14
BT50FC-C8-070T	C8	50	80	70	32	M24	170	14

Applicable for 7 MPa coolant

(1) Recommended clamping torque (N-m)

HSK-A-C/-T

Basic holder for HSK shank

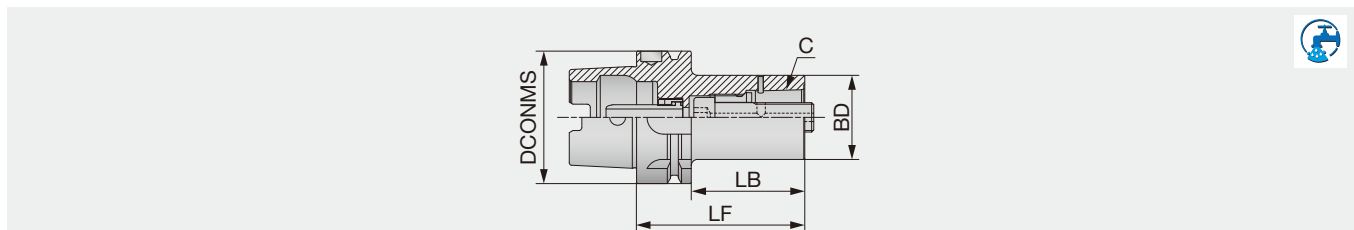

Designation	DCONMS	C	BD	LF	LB	Nm ⁽¹⁾	Wrench size
HSK63A-C4-080T*	63	C4	40	80	54	55	8
HSK63A-C5-090T*	63	C5	50	90	64	95	10
C5ADHСКА100WHX100*	100	C5	50	100	71	95	10
HSK63A-C6-110T*	63	C6	63	110	74	170	14
C6ADHСКА100WHX110*	100	C6	63	110	81	170	14
HSK100A-C6-110	100	C6	63	110	81	170	14
C8ADHСКА100WHX120*	100	C8	80	120	91	170	14
HSK100A-C8-120	100	C8	80	120	91	170	14

* HSK Standards ICTM with ISO 12164-3

Applicable for 7 MPa coolant. To enable clamping the part to be attached, first remove the cooling tube. Option: Cooling tube wrench

(1) Recommended clamping torque (N-m)

C-ADSKA

Basic holder for DIN69871 Form AD/ADB tapered shank

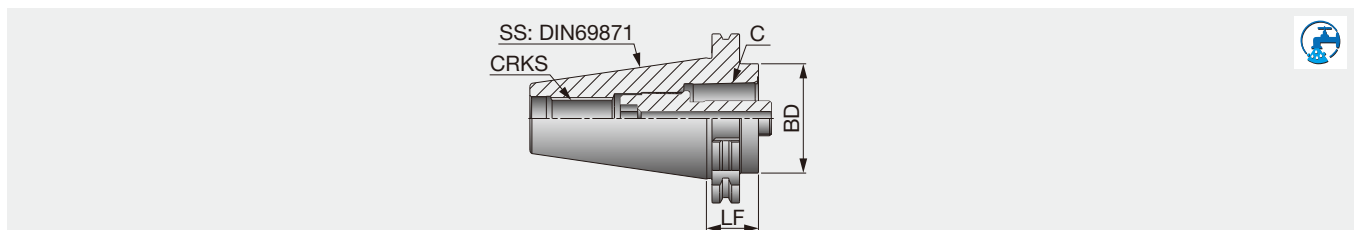

Designation	C	SS	BD	LF	CRKS	Nm ⁽¹⁾	Wrench size
C4ADSKA40X30	C4	40	40	30	M16	55	8
C5ADSKA40X30	C5	40	50	30	M16	95	10
C5ADSKA50X30ADB	C5	50	50	30	M24	95	10
C6ADSKA50X30	C6	50	63	30	M24	170	14
C8ADSKA50X70ADB	C8	50	80	70	M24	170	14

Applicable for 7 MPa coolant

(1) Recommended clamping torque (N-m)

Basic holder for caterpillar AD/ADB tapered shank

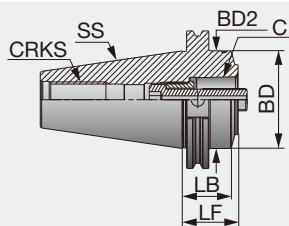

Designation	C	SS	BD	BD2	LF	LB	CRKS	Nm ⁽¹⁾	Wrench size
C4ADCATI40X40ADB	C4	40	40	44.5	40	35	5/8-11	55	8
C5ADCATI40X90ADB	C5	40	50	45.2	90	35	5/8-11	95	10
C5ADCATI50X40ADB	C5	50	50	69.9	40	35	1-8	95	10
C6ADCATI50X50	C6	50	63	69.85	50	37	1-8	170	14
C8ADCATI50X100ADB	C8	50	80	70.1	100	35	1-8	170	14

Applicable for 7 MPa coolant

(1) Recommended clamping torque (N-m)

C-EX

Extension adapter

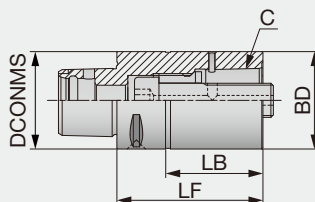

Designation	C	DCONMS	BD	LF	LB	Nm ⁽¹⁾	Wrench size
C3EXC3X060	C3	32	32	60	-	45	7
C3EXC3X080	C3	32	32	80	-	45	7
C4EX-060	C4	40	40	60	40	65	8
C4EX-080	C4	40	40	80	60	65	8
C5EX-080	C5	50	50	80	60	95	10
C5EX-100	C5	50	50	100	80	95	10
C6EX-100	C6	63	63	100	78	170	14
C6EX-140	C6	63	63	140	118	170	14
C8EX-100	C8	80	80	100	70	170	14
C8EX-160	C8	80	80	160	130	170	14

Applicable for 7 MPa coolant

(1) Recommended clamping torque (N-m)

Side lock

Collet chuck

Face mill

Milling chuck

Hydro chuck

Shrinking chuck

Others

C-RE

Reduction adapter

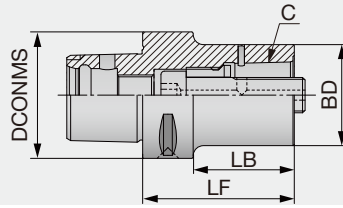

Designation	C	DCONMS	BD	LF	LB	Nm ⁽¹⁾	Wrench size
C5-C4RE-060	C4	50	40	60	40	55	8
C5-C4RE-080	C4	50	40	80	60	55	8
C6-C4RE-080	C4	63	40	80	58	55	8
C6-C5RE-080	C5	63	50	80	58	95	10
C6-C5RE-120	C5	63	50	120	98	95	10
C8-C4RE-070	C4	80	40	70	40	55	8
C8-C5RE-080	C5	80	50	80	50	95	10
C8-C6RE-080	C6	80	63	80	50	170	14
C8-C6RE-120	C6	80	63	120	90	170	14

Applicable for 7 MPa coolant

(1) Recommended clamping torque (N·m)

MULTI CLAMP (TungCap)

Multi-clamp fixture for TungCap

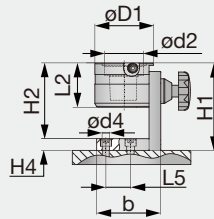

Designation	CSI	ød2	øD1	L2	H1	H2	H4	b	L5	ød4
MULTICLAMPC3	C3	32	70	64	128	109	19	104	40	12.5
MULTICLAMPC4	C4	40	78	67	137	118	19	104	40	12.5
MULTICLAMPC5	C5	50	85	72	142	123	19	104	40	12.5
MULTICLAMPC6	C6	63	95	72	142	123	19	104	40	12.5
MULTICLAMPC8	C8	80	130	90	178	159	19	144	85	12.5

TungCap Test bar

Test bar

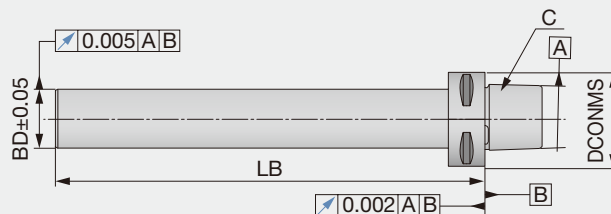

Designation	C	DCONMS	BD	LB
C3-TB-160	C3	32	25	160
C4-TB-160	C4	40	25	160
C5-TB-160	C5	50	30	180
C6-TB-220	C6	63	35	220
C8-TB-250	C8	80	40	250

TUNGCAP

SWISS TOOLS®

Fine boring heads with digital display



Fine boring head system makes **micron adjustment easy and simple in the machine**

- Easy but accurate adjustment: 1 μm accuracy is possible on the machine
- Digital display: the display unit is docked on the boring head for micron adjustment
- Economy: One digital unit can be used with all fine boring heads
- Internal coolant for smooth chip control
- Also available with TungCap connection, allowing it for use in multi-tasking machines

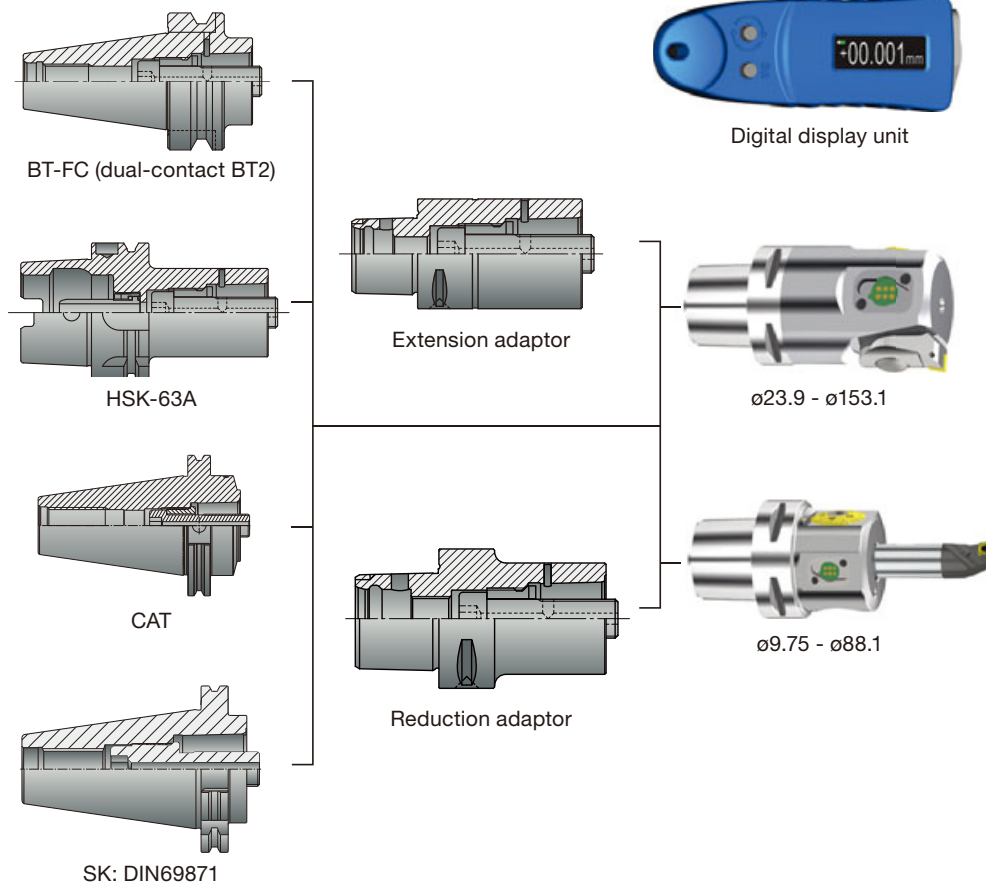

Reference pages: **K053 - K054**

TungCap FBHO-DE

Fine boring head for digital display $\varnothing 9.75$ mm - $\varnothing 88.1$ mm

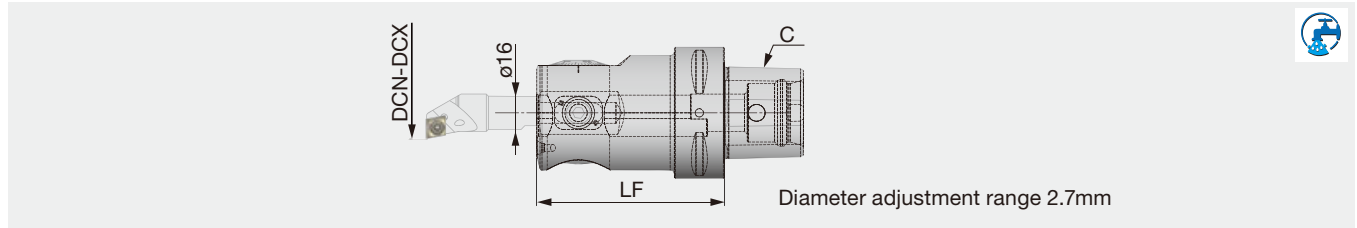

Designation	C	DCN	DCX	LF	Boring bar
BT4-FBHO-DE-1690	BT40	9.75	88.1	90	254.0**.006... / 256...
HA6-FBHO-DE-1695	HSK-A63	9.75	88.1	95	254.0**.006... / 256...
PSC63-FBHO-DE-1690	C6	9.75	88.1	90	254.0**.006... / 256...
PSC50-FBHO-DE-1670	C5	9.75	88.1	70	254.0**.006... / 256...
PSC40-FBHO-DE-1665	C4	9.75	88.1	65	254.0**.006... / 256...

Applicable for 7 MPa coolant

TungCap 254.0**.006.**

Boring bar

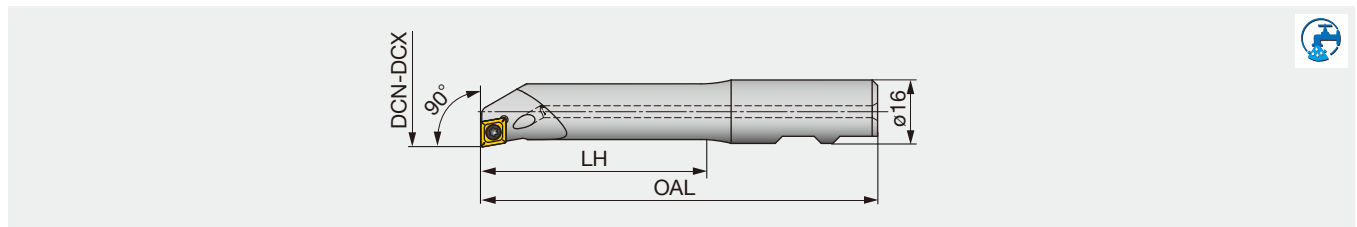

Designation	DCN	DCX	LH	OAL	Insert
254.010.006.075	9.75	15.1	30	75	CC**0602...
254.015.006.090	14.75	20.1	51	90	CC**0602...
254.020.006.105	19.75	25.1	72	105	CC**0602...
254.025.006.115	24.75	30.1	82	115	CC**0602...

Applicable for 7 MPa coolant

SPARE PARTS

Designation	Clamping screw	Wrench
254.0**.006.**	CSTB-2.5S	T-8F

TungCap 256.0**.0**.115

Boring bar

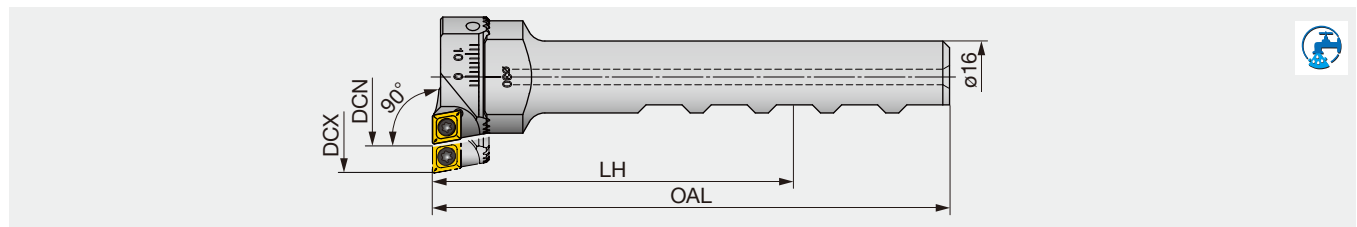

Designation (Shank)	Designation (Insert holder)	DCN	DCX	LH	OAL	Insert
256.030.048.115	256.030.006.012	29.75	48.1	85	115	CC**0602...
256.048.088.115	256.048.006.014	47.75	88.1	85	115	CC**0602...

Applicable for 7 MPa coolant

SPARE PARTS

Designation	Clamping screw	Wrench
256.0**.006.0**	CSTB-2.5S	T-8F

Reference pages: 254.0**.006.**: Inserts → **B112 -**, CBN → **B190**, PCD → **B213**
 256.0**.0**.115: Inserts → **B112 -**, CBN → **B190**, PCD → **B213**



Fine boring head for digital display $\varnothing 23.9$ mm - $\varnothing 153.1$ mm

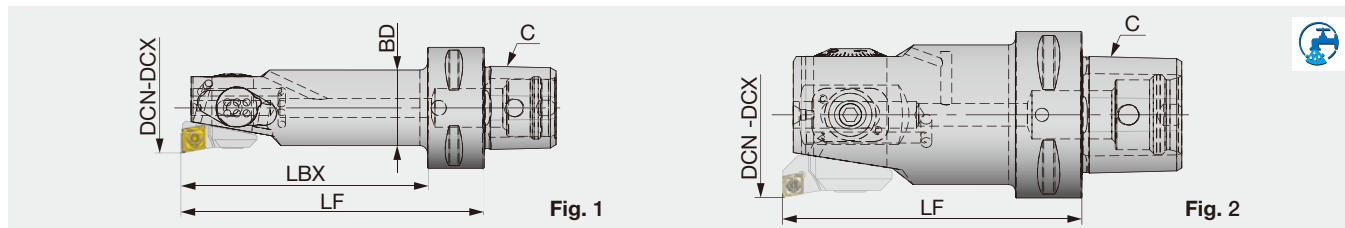

Designation	C	DCN	DCX	LF	LBX	BD	Fig.	Insert holder
PSC32-FBHS-DE-24	C3	23.9	31.1	80	65	20	1	314.011.024.006/007
PSC32-FBHS-DE-24	C3	29.9	37.1	80	65	20	1	314.011.030.006/007
PSC32-FBHS-DE-31	C3	30.9	40.1	90	75	25	1	314.013.031.006/007
PSC32-FBHS-DE-31	C3	37.5	47.1	90	75	25	1	314.013.038.006/007
PSC40-FBHS-DE-40	C4	39.9	51.1	90	70	32	1	314.017.040.006/007
PSC40-FBHS-DE-40	C4	47.5	59.1	90	70	32	1	314.017.048.006/007
PSC50-FBHS-DE-51	C5	50.9	67.1	90	-	-	2	314.022.051.006/007
PSC50-FBHS-DE-51	C5	64.9	81.1	90	-	-	2	314.022.065.006/007
PSC50-FBHS-DE-67	C5	66.9	87.1	100	-	-	2	314.030.067.009/011
PSC50-FBHS-DE-67	C5	84.9	105.1	100	-	-	2	314.030.085.009/011
PSC63-FBHS-DE-87	C6	86.9	116.1	120	-	-	2	314.030.067.009/011
PSC63-FBHS-DE-87	C6	104.9	134.1	120	-	-	2	314.030.085.009/011
PSC63-FBHS-DE-116	C6	115.9	153.1	150	-	-	2	314.030.067.009/011
PSC63-FBHS-DE-116	C6	133.9	171.1	150	-	-	2	314.030.085.009/011

Insert holders are sold separately.
Applicable for 7 MPa coolant

TungCap 314.0**.0**.0**

Insert holder of fine boring head for digital display $\varnothing 23.9$ mm - $\varnothing 153.1$ mm

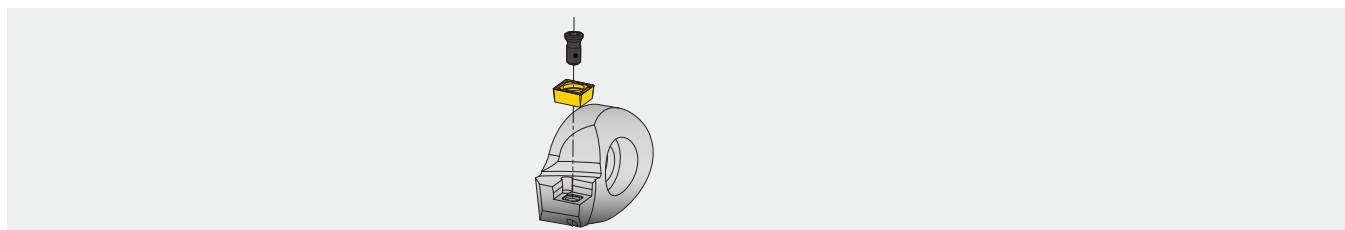

Designation (Insert holder)	Insert
314.011.024.006	CC**0602...
314.013.031.006	CC**0602...
314.017.040.006	CC**0602...
314.022.051.006	CC**0602...
314.030.067.009	CC**08T3..

SPARE PARTS

Designation	Clamping screw	Wrench
314.0**.0**.0**	CSTB-2.5S	T-8F

TungCap GH1-DA

Digital display unit



Designation
GH1-DA2.BG0.077

Reference pages: 314.0**.0**.0**: Inserts → **B112 -**, CBN → **B190**, PCD → **B213**

Nomenclature for clamping units

Clamping units

Clamping units for non-rotating and rotating tools, designed for turret lathes

- Clamping units for standard square and round shanks
- Clamping units for PSC Bolt-on clamp interface
- Clamping units for Vertical Disc Interface (VDI DIN69880)



Standard interface



PBI



VDI (DIN69880)

Clamping units

	For external (Tool setting direction cross X)	For internal (Tool setting direction straight Z)
Turning clamping unit	C*-DTO-*C-***-R/L 	C*-DTI-*C-***-R/L
	C*-DDC-*C-**** 	C*-DDS-*C-****

Nomenclature for clamping units

Nomenclature for static clamping unit

C4 - DTI - IC - ABC401 - R

1	2	3	4	5	6	7
PSC size	Device	Motion	Application	Coolant	Unit number	Hand
C3	D	T Static (turning tool)	O For external turning	IC Internal	Manufacturer's symbol	R Right
C4			I For internal turning	OC External		L Left
C5			S Others			
C6						
C8						

Nomenclature for driven clamping unit

C5 - DDC - OC - ABC501

1	2	3	4	5	6
PSC size	Device	Motion	Application	Coolant	Unit number
C3	D	D Driven (rotating tool)	S Straight: Z	OC External	Manufacturer's symbol
C4			C Cross: X	WC Internal / External	
C5			X Others		
C6					
C8					

Manual clamping unit, square shank

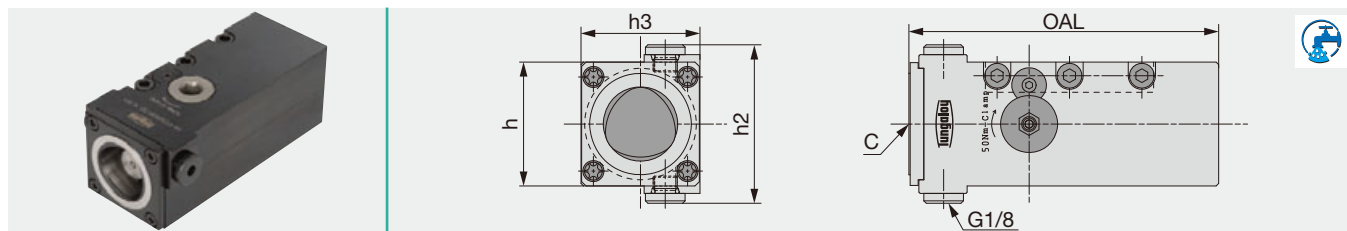

Designation	C	Turret size h	h3	h2	OAL	Torque ⁽¹⁾
C3-DTOS4038R/L	C3	40	38	62	95	35
C4-DTOS5048R/L	C4	50	48	64	125	50
C5-DTOS6464R/L	C5	60	64	68	145	70

Applicable for 7 MPa coolant

(1) Recommended clamping torque (N-m)

C-DTIR

Manual clamping unit, round shank

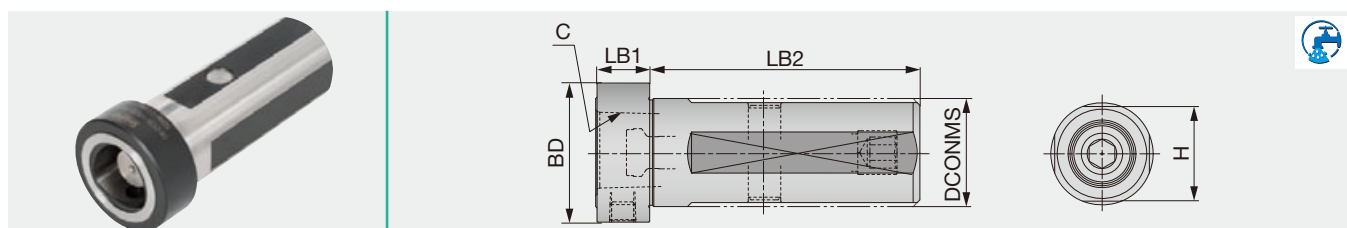

Designation	C	DCONMS	BD	H	LB2	LB1	Torque ⁽¹⁾
C3-DTIR-08018-D32	C3	32	41.5	30	80	18	35
C4-DTIR-10020-D40	C4	40	51.5	37	100	20	50
C4-DTIR-12020-D50	C4	50	51.5	47	120	20	50
C5-DTIR-12024-D50	C5	50	61.5	47	120	24	70

Applicable for 7 MPa coolant

(1) Recommended clamping torque (N-m)

C-DTOFR/L

Manual clamping unit, fixed type

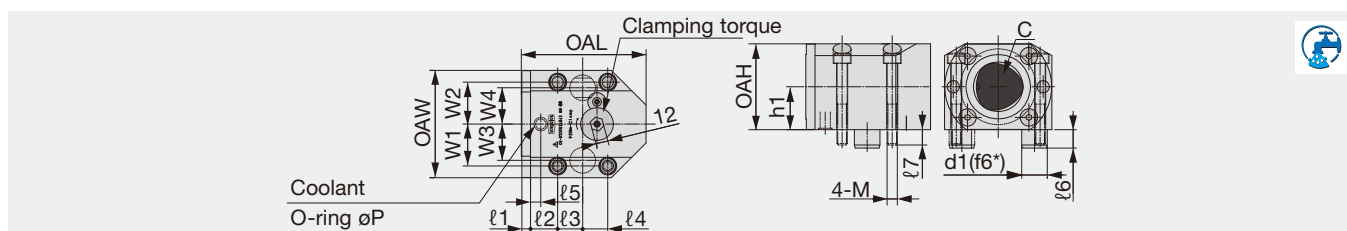

Designation	C	OAH	h1	OAL	OAW	W1	W2	W3	W4	l1	l2	l3	l4	l5	l6	l7	d1(f6*)	P	M	Torque ⁽¹⁾
C5-DTOFR/L32048	C5	64	32	100	92	35	31	8	19	21	7	11	15	20	P8	M10	70			
C6-DTOFR/L42060	C6	84	42	122	105	41	35.5	9	26.5	24.5	10	18	15	25	P10	M10	90			
C8-DTOFR/L50088	C8	100	50	146	133	55	46	12	33	43	13	19	20	32	P11	M12	130			

Applicable for 7 MPa coolant

*f6 tolerance: d20 & 25 = -0.022 / -0.033, d32 = -0.025 / -0.041
(1) Recommended clamping torque (N-m)

Clamping units & tools for CNC lathes

Selection for External turning

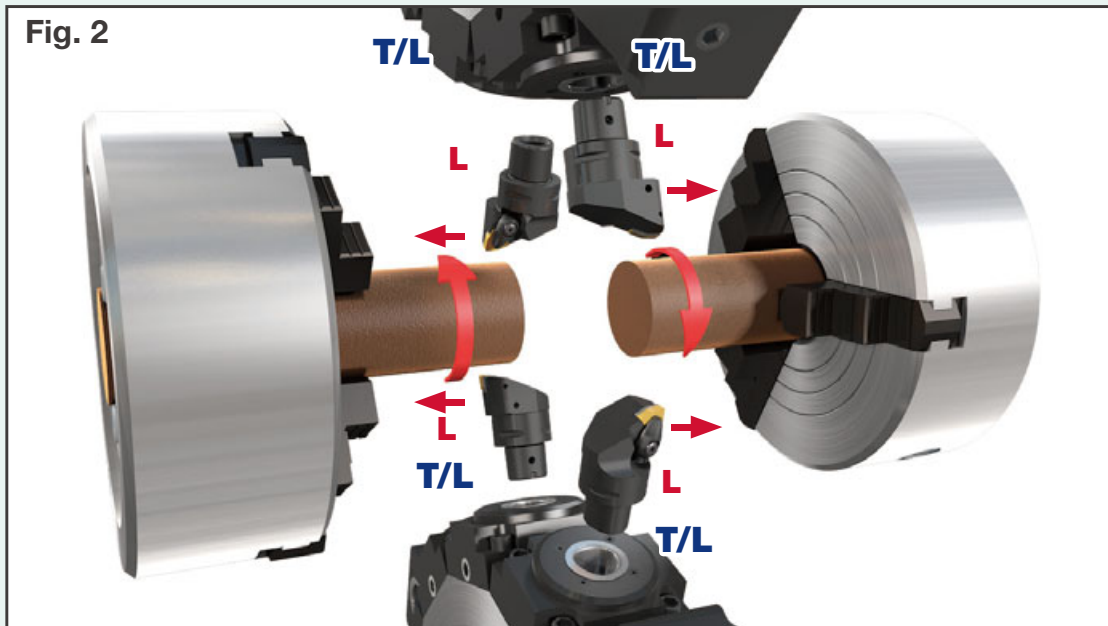
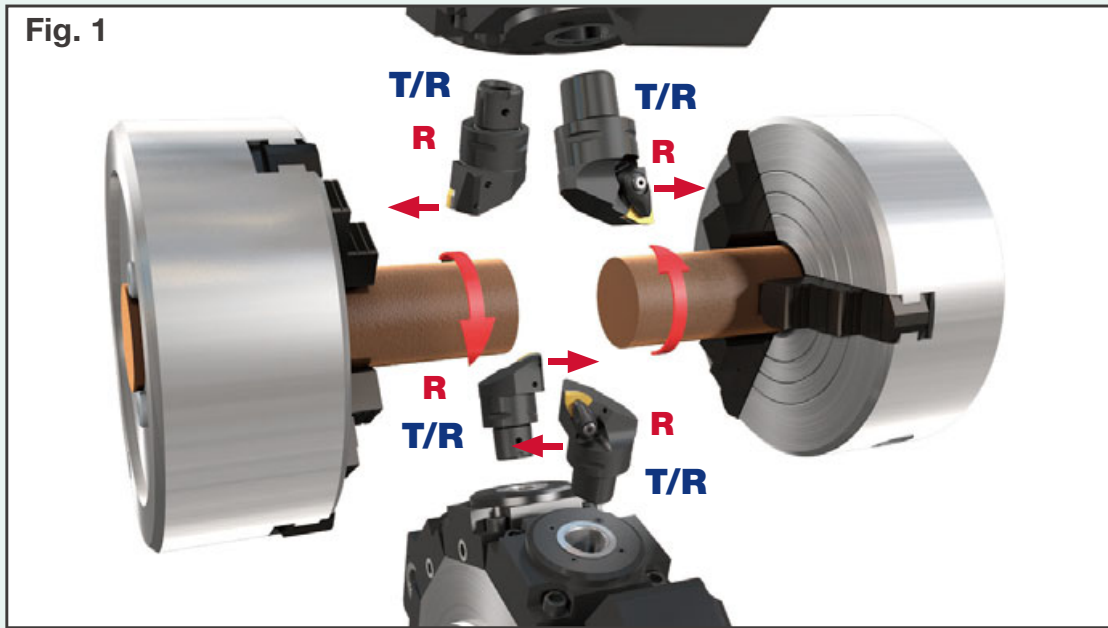

R: Right hand cutting tool **L:** Left hand cutting tool

T/R: Right hand clamping unit **T/L:** Left hand clamping unit

Grade

Insert

Ext. Toolholder

Int. Toolholder

Threading

Grooving

Miniature tool

Milling cutter

Endmill

Drilling tool

Tooling System

User's Guide

Index

Clamping units & tools for CNC lathes

Selection for Internal turning

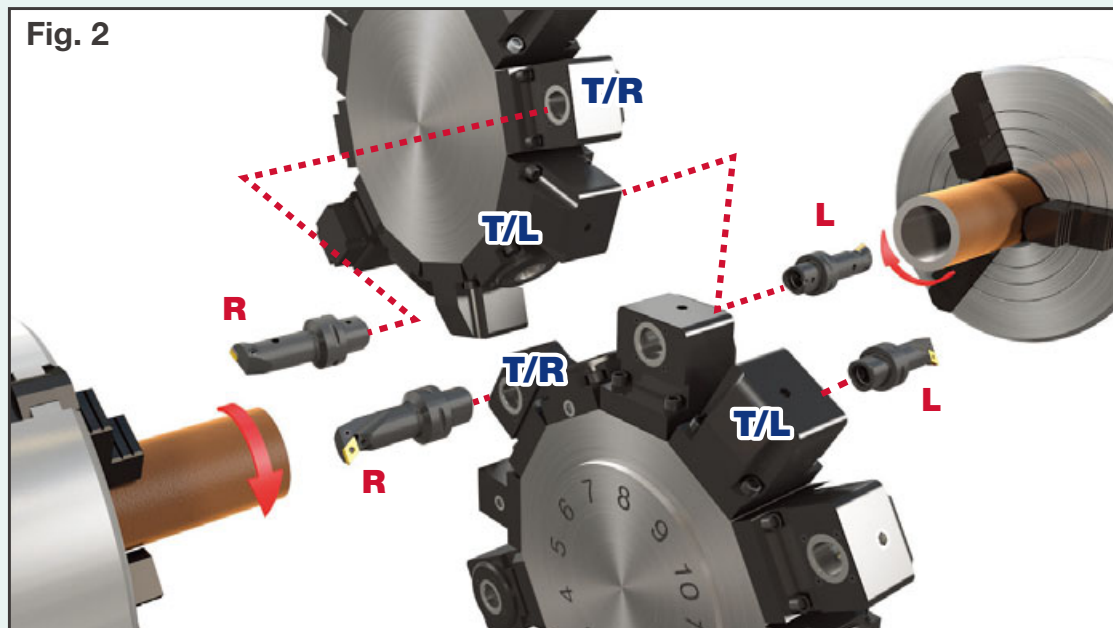
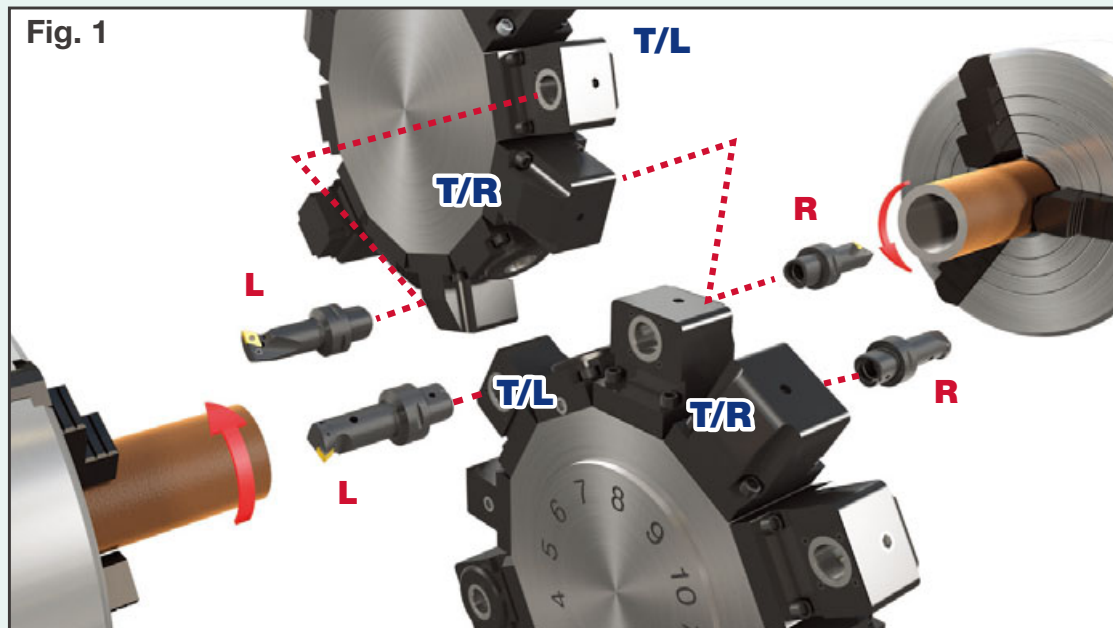

R: Right hand cutting tool **L:** Left hand cutting tool

T/R: Right hand clamping unit **T/L:** Left hand clamping unit

Side lock

Collet chuck

Face mill

Milling chuck

Hydro chuck

Shrinking chuck

Others

Clamping torque



PSC size	Tightening torque recommendation (N·m)	Clamping force (KN)	Torque wrench size	
			Static tool unit	Driven tool unit
C3	35	15	8	6
C4	50	20	10	8
C5	70 (75*)	25	12	10
C6	90 (110*)	30	12	12
C8	130	40	12	12

* Torque value for driven tool unit

Grade

Insert

Ext. Toolholder

Int. Toolholder

Threading

Grooving

Miniature tool

Milling cutter

Endmill

Drilling tool

Tooling System

User's Guide

Index

DIN69871-ER

ER collet chuck holder (DIN69871)

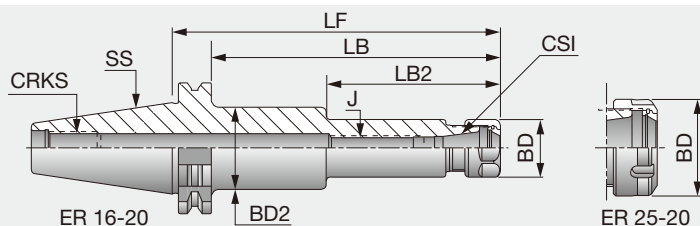

Designation	SS	CSI	Range	LF	LB	LB2	BD	BD2	J	CRKS
DIN6987130ER16X63 ⁽¹⁾	30	ER16	0.5-10	63	43.9	28	28	-	M10	M12
DIN6987140ER16X63	40	ER16	0.5-10	63	43.9	-	28	-	M12	M16
DIN6987140ER16X63B	40	ER16	0.5-10	63	43.9	-	28	-	M12	M16
DIN6987140ER16X100	40	ER16	0.5-10	100	80.9	-	28	-	M12	M16
DIN6987140ER16X160	40	ER16	0.5-10	160	140.9	85	28	40	M12	M16
DIN6987140ER16X160B	40	ER16	0.5-10	160	140.9	85	28	40	M12	M16
DIN6987140ER20X63	40	ER20	1-13	63	43.9	-	34	-	M12	M16
DIN6987140ER20X63B	40	ER20	1-13	63	43.9	-	34	-	M12	M16
DIN6987140ER20X100	40	ER20	1-13	100	80.9	-	34	-	M12	M16
DIN6987140ER20X100B	40	ER20	1-13	100	80.9	-	34	-	M12	M16
DIN6987140ER20X160	40	ER20	1-13	160	140.9	91	34	44	M12	M16
DIN6987150ER16X100 ⁽¹⁾	50	ER16	0.5-10	100	80.9	-	28	-	M12	M24
DIN6987150ER16X100B	50	ER16	0.5-10	100	80.9	-	28	-	M12	M24
DIN6987150ER16X160 ⁽¹⁾	50	ER16	0.5-10	160	140.9	85	28	40	M12	M24
DIN6987150ER16X200 ⁽¹⁾	50	ER16	0.5-10	200	180.9	110	28	40	M10	M24
DIN6987150ER20X100 ⁽¹⁾	50	ER20	1-13	100	80.9	-	34	-	M12	M24
DIN6987150ER20X100B	50	ER20	1-13	100	80.9	-	34	-	M12	M24
DIN6987150ER20X160 ⁽¹⁾	50	ER20	1-13	160	140.9	86	34	45	M12	M24
DIN6987130ER32X65 ⁽¹⁾	30	ER32	2-20	65	45.9	32	50	40.4	M18x1.5	M12
DIN6987140ER25X65	40	ER25	1-16	65	45.9	28	42	32.4	M16x2	M16
DIN6987140ER25X65B	40	ER25	1-16	65	45.9	28	42	32.4	M16X2	M16
DIN6987140ER25X100	40	ER25	1-16	100	80.9	-	42	-	M16x2	M16
DIN6987140ER25X150	40	ER25	1-16	150	130.9	-	42	-	M16x2	M16
DIN6987140ER25X150B	40	ER25	1-16	150	130.9	-	42	-	M16X2	M16
DIN6987140ER32X65	40	ER32	2-20	65	45.9	32	50	40.4	M22x1.5	M16
DIN6987140ER32X100	40	ER32	2-20	100	80.9	35	50	49	M22x1.5	M16
DIN6987140ER32X150	40	ER32	2-20	150	130.9	35	50	49	M22x1.5	M16
DIN6987140ER40X70	40	ER40	3-26	70	50.9	32	63	50.4	M28x1.5	M16
DIN6987140ER40X70B	40	ER40	3-26	70	50.9	32	63	50.4	M28X1.5	M16
DIN6987140ER40X100	40	ER40	3-26	100	80.9	32	63	50.4	M28x1.5	M16
DIN6987140ER40X100B	40	ER40	3-26	100	80.9	32	63	50.4	M28X1.5	M16
DIN6987150ER25X100 ⁽¹⁾	50	ER25	1-16	100	80.9	-	42	-	M16x2	M24
DIN6987150ER25X100B	50	ER25	1-16	100	80.9	-	42	-	M16X2	M24
DIN6987150ER25X150 ⁽¹⁾	50	ER25	1-16	150	130.9	80.9	42	50	M16x2	M24
DIN6987150ER25X150B	50	ER25	1-16	150	130.9	80.9	42	50	M16X2	M24
DIN6987150ER25X200 ⁽¹⁾	50	ER25	1-16	200	180.9	85	42	55	M16x2	M24
DIN6987150ER32X100 ⁽¹⁾	50	ER32	2-20	100	80.9	-	50	-	M22x1.5	M24
DIN6987150ER32X150 ⁽¹⁾	50	ER32	2-20	150	130.9	-	50	-	M22x1.5	M24
DIN6987150ER32X150B	50	ER32	2-20	150	130.9	-	50	-	M22X1.5	M24
DIN6987150ER32X200 ⁽¹⁾	50	ER32	2-20	200	180.9	-	50	-	M22x1.5	M24
DIN6987150ER40X100 ⁽¹⁾	50	ER40	3-26	100	80.9	-	63	-	M28x1.5	M24
DIN6987150ER40X100B	50	ER40	3-26	100	80.9	-	63	-	M28X1.5	M24
DIN6987150ER40X150 ⁽¹⁾	50	ER40	3-26	150	130.9	-	63	-	M28x1.5	M24
DIN6987150ER40X200 ⁽¹⁾	50	ER40	3-26	200	180.9	-	63	-	M28x1.5	M24
DIN6987150ER40X200B	50	ER40	3-26	200	180.9	-	63	-	M28X1.5	M24
DIN6987150ER50X100 ⁽¹⁾	50	ER50	10-34	100	80.9	-	78	-	M36x1.5	M24
DIN6987150ER50X100B	50	ER50	10-34	100	80.9	-	78	-	M36X1.5	M24
DIN6987150ER50X150 ⁽¹⁾	50	ER50	10-34	150	130.9	-	78	-	M36x1.5	M24

• Applicable for 10 MPa coolant •Add B at the end of the designation for the item with coolant through the flange.
 (1) Balanced to G6.3 max.n: 12,000 min⁻¹

Option: Wrench for ER collet

Reference pages



ER collet

K124 -



Nut

K148



Wrench

K150



Preset screw

K151



Pull stud

K147

TUNGSHORT

DIN69871-ER-SHORT

ER collet chuck holder, short type (DIN69871)

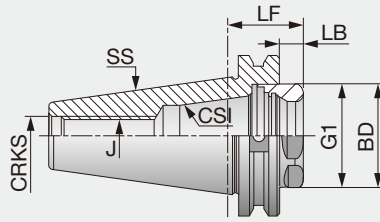

Designation	SS	CSI	Range	LF	LB	BD	J	CRKS	G1
DIN6987140ER32SHORT	40	ER32	2-20	25.1	6	40	M16	M16	M40x1.5
DIN6987150ER32SHORT	50	ER32	2-20	28.6	9.5	40	M22x1.5	M24	M40x1.5
DIN6987150ER40SHORT	50	ER40	3-26	28.6	9.5	50	M28x1.5	M24	M50x1.5

- Applicable for 10 MPa coolant
- Add B at the end of the designation for the item with coolant through the flange.

Option: Wrench for ER collet

TUNGMAX

DIN69871-TUNGMAX

Power chuck holder (DIN69871)

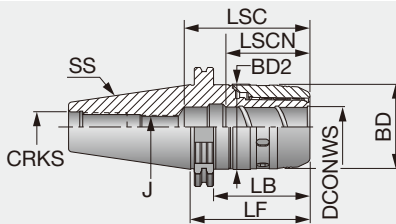

Designation	SS	DCONWS	Range	LF	LB	LSCN	LSC	BD	BD2	J	CRKS
DIN6987140MAXIN20X95	40	20	6-20	95	76	56	69	51	53	M16	M16
DIN6987150MAXIN20X105 ⁽¹⁾	50	20	6-20	105	86	56	69	51	53	M16	M24
DIN6987150MAXIN32X100 ⁽¹⁾	50	32	6-32	100	81	70	84	69	70	M20x2	M24
DIN6987150MAXIN32X135 ⁽¹⁾	50	32	6-32	135	116	71	85	69	70	M20x2	M24

- Applicable for 10 MPa coolant
 - Add B at the end of the designation for the item with coolant through the flange.
- (1) Balanced to G6.3 max.n: 8,000 min⁻¹

Option: Clamping wrench

Reference pages

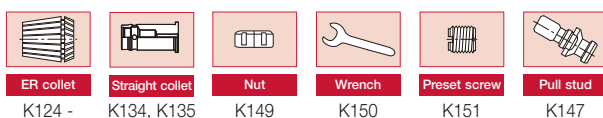

K124 -

K134, K135

K149

K150

K151

K147

TUNG HYDRO

DIN69871-HYDRO

Hydraulic endmill chuck holder (DIN69871)

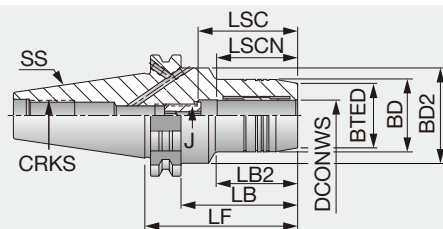

Designation	SS	DCONWS	BTED	BD	BD2	LF	LB	LB2	LSCN	LSC	J	CRKS
DIN6987130HYDRO6X60	30	6	23	26	45	60	41	25	27	37	M5	M12
DIN6987130HYDRO16X90	30	16	34	38	45	90	71	43	42	52	M12x1	M12
DIN6987130HYDRO20X90	30	20	38	42	42	90	71	-	42	52	M12x1	M12
DIN6987140HYDRO6X68	40	6	23	26	50	68	49	33	27	37	M5	M16
DIN6987140HYDRO8X68	40	8	25	28	50	68	49	33	27	37	M6	M16
DIN6987140HYDRO10X72	40	10	27	30	50	72	53	37	32	42	M8x1	M16
DIN6987140HYDRO12X77	40	12	29	32	50	77	58	42	37	47	M10x1	M16
DIN6987140HYDRO14X77	40	14	30	34	50	77	58	42	37	47	M10x1	M16
DIN6987140HYDRO16X80	40	16	34	38	50	80	61	43	42	52	M12x1	M16
DIN6987140HYDRO18X80	40	18	36	40	50	80	61	43	42	52	M12x1	M16
DIN6987140HYDRO20X82	40	20	38	42	50	82	63	47	42	52	M12x1	M16
DIN6987140HYDRO25X117	40	25	46	50	63	117	98	51	48	58	M16x1	M16
DIN6987140HYDRO32X117	40	32	56	60	63	117	98	56	52	62	M16x1	M16
DIN6987150HYDRO6X68	50	6	23	26	80	68	49	33	27	37	M5	M24
DIN6987150HYDRO8X68	50	8	25	28	80	68	49	33	27	37	M6	M24
DIN6987150HYDRO10X72	50	10	27	30	80	72	53	37	32	42	M8x1	M24
DIN6987150HYDRO12X77	50	12	29	32	80	77	58	42	37	47	M10x1	M24
DIN6987150HYDRO14X77	50	14	30	34	80	77	58	42	37	47	M10x1	M24
DIN6987150HYDRO16X80	50	16	34	38	80	80	61	45	42	52	M12x1	M24
DIN6987150HYDRO18X80	50	18	36	40	80	80	61	45	42	52	M12x1	M24
DIN6987150HYDRO20X82	50	20	38	42	80	82	63	47	42	52	M16x1	M24
DIN6987150HYDRO25X87	50	25	46	50	80	87	68	52	48	58	M16x1	M24
DIN6987150HYDRO32X91	50	32	56	60	80	91	72	56	54	64	M16x1	M24
DIN6987140HYDRO20X64.5 ⁽¹⁾	40	20	40	49.5	-	64.5	45	-	42	52	M16x1	M16
DIN6987150HYDRO32X81 ⁽¹⁾	50	32	56	72	-	81	62	-	54	64	M16x1	M24

- Applicable for 10 MPa coolant
 - Clamping wrench (WRENCH HYDRO HEX 4) is sold separately.
 - Reduction sleeves are available for DCONWS = 12, 20, 25, and 32mm (sold separately). Chucking force will reduce when using a reduction sleeve.
- (1) Holders for heavy duty

Reference pages



Straight collet

K137



Pull stud

K147



Wrench

K150

DIN69871-EM

Side lock holder for weldon endmills (DIN69871)

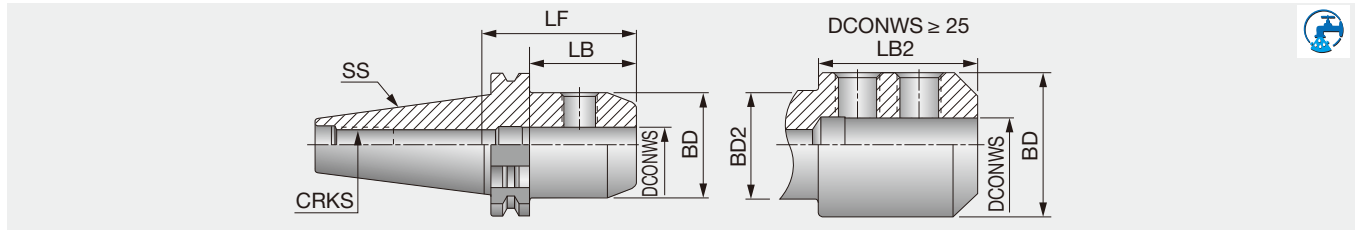

Designation	SS	DCONWS	BD	BD2	LF	LB	LB2	CRKS
DIN6987130EM6X50	30	6	26	-	50	30.9	-	M12
DIN6987130EM8X50	30	8	28	-	50	30.9	-	M12
DIN6987130EM10X50	30	10	35	-	50	30.9	-	M12
DIN6987130EM16X63	30	16	48	44.9	63	43.9	28	M12
DIN6987130EM18X72	30	18	50	44.9	72	52.9	37	M12
DIN6987130EM20X72	30	20	52	44	72	52.9	37	M12
DIN6987140EM6X50	40	6	25	-	50	30.9	-	M16
DIN6987140EM8X50	40	8	28	-	50	30.9	-	M16
DIN6987140EM10X50	40	10	35	-	50	30.9	-	M16
DIN6987140EM12X50	40	12	42	-	50	30.9	-	M16
DIN6987140EM14X63	40	14	44	-	63	43.9	-	M16
DIN6987140EM16X63	40	16	48	-	63	43.9	-	M16
DIN6987140EM18X63	40	18	50	49	63	43.9	28.5	M16
DIN6987140EM20X63	40	20	52	49	63	43.9	28.5	M16
DIN6987140EM20X63B	40	20	52	49	63	43.9	28.5	M16
DIN6987140EM25X100	40	25	65	49	100	80.9	65	M16
DIN6987140EM25X100B	40	25	65	49	100	80.9	65	M16
DIN6987140EM32X100	40	32	71	49	100	80.9	65	M16
DIN6987150EM6X63	50	6	25	-	63	43.9	-	M24
DIN6987150EM8X63	50	8	28	-	63	43.9	-	M24
DIN6987150EM8X63B	50	8	28	-	63	43.9	-	M24
DIN6987150EM10X63	50	10	35	-	63	43.9	-	M24
DIN6987150EM12X63	50	12	42	-	63	43.9	-	M24
DIN6987150EM14X63	50	14	44	-	63	43.9	-	M24
DIN6987150EM16X63	50	16	48	-	63	43.9	-	M24
DIN6987150EM18X63	50	18	50	-	63	43.9	-	M24
DIN6987150EM20X63	50	20	52	-	63	43.9	-	M24
DIN6987150EM25X80	50	25	65	-	80	60.9	-	M24
DIN6987150EM25X80B	50	25	65	-	80	60.9	-	M24
DIN6987150EM32X100	50	32	72	-	100	80.9	-	M24
DIN6987150EM32X100B	50	32	72	-	100	80.9	-	M24
DIN6987150EM40X100	50	40	90	79.9	100	80.9	43	M24
DIN6987150EM50X125	50	50	98	79.9	125	105.9	90	M24
DIN6987140EM10X45 ⁽¹⁾	40	10	35	-	45	25.9	-	M16
DIN6987140EM12X45 ⁽¹⁾	40	12	42	-	45	25.9	-	M16
DIN6987140EM14X45 ⁽¹⁾	40	14	44	-	45	25.9	-	M16
DIN6987140EM16X45 ⁽¹⁾	40	16	48	-	45	25.9	-	M16
DIN6987140EM18X45 ⁽¹⁾	40	18	49	-	45	25.9	-	M16
DIN6987140EM20X45 ⁽¹⁾	40	20	49	-	45	25.9	-	M16
DIN6987140EM25X45 ⁽¹⁾	40	25	49	-	45	25.9	-	M16

- Applicable for 10 MPa coolant
- Add B at the end of the designation for the item with coolant through the flange.
- (1) Short endmill holder

Reference pages

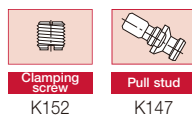

DIN69871-EM E

Side lock holder for whistle notch (DIN69871)

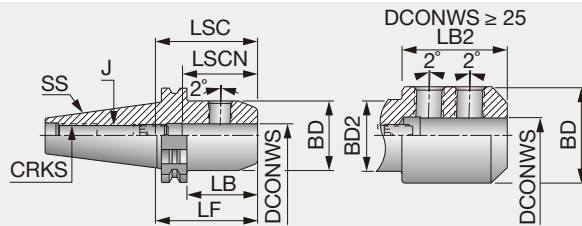

Designation	SS	DCONWS	BD	BD2	LF	LB	LB2	LSCN	LSC	J ⁽¹⁾	CRKS	Wrench
DIN6987140EM8X50E	40	8	28	-	50	30.9	-	35	45	M6	M16	3
DIN6987140EM10X50E	40	10	35	-	50	30.9	-	39	49	M8	M16	4
DIN6987140EM12X50E	40	12	42	-	50	30.9	-	44	54	M10	M16	5
DIN6987140EM16X63E	40	16	48	-	63	43.9	-	47	57	M12	M16	6
DIN6987140EM18X63E	40	18	50	49	63	43.9	28.5	47	57	M12	M16	6
DIN6987140EM20X63E	40	20	52	49	63	43.9	29	49	59	M16	M16	8
DIN6987140EM25X100E	40	25	65	49	100	80.9	65	54	64	M20X1.5	M16	10
DIN6987140EM32X100E	40	32	72	49	100	80.9	65	58	68	M20X1.5	M16	10
DIN6987150EM10X63E	50	10	35	-	63	43.9	-	39	49	M8	M24	4
DIN6987150EM12X63E	50	12	42	-	63	43.9	-	44	54	M10	M24	5
DIN6987150EM14X63E	50	14	44	-	63	43.9	-	44	54	M10	M24	5
DIN6987150EM16X63E	50	16	48	-	63	43.9	-	47	57	M12	M24	6
DIN6987150EM20X63E	50	20	52	-	63	43.9	-	49	49	M16	M24	8
DIN6987150EM20X63EB	50	20	52	-	63	43.9	-	49	49	M16	M24	8
DIN6987150EM25X80E	50	25	65	-	80	60.9	-	54	64	M20X1.5	M24	10
DIN6987150EM32X100E	50	32	72	-	100	80.9	-	58	68	M20X1.5	M24	10
DIN6987150EM40X100E	50	40	90	79.9	100	80.9	43	68	78	M20X1.5	M24	10

- Applicable for 10 MPa coolant
- Add B at the end of the designation for the item with coolant through the flange.
- (1) Preset screw has an internal coolant hole.

TUNGSHRINK

DIN69871-SRK

Thermal shrinking holder for carbide shank (DIN69871)

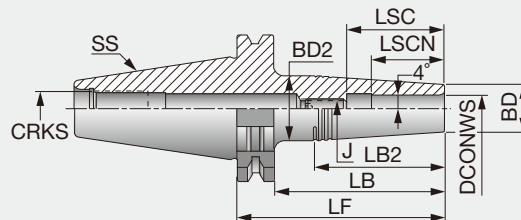

Designation	SS	DCONWS	BD	BD2	LF	LB	LB2	LSCN	LSC	J	CRKS	Wrench
DIN6987140SRK3X50	40	3	10	15	69.1	50	35.55	10	16	M6	M16	3
DIN6987140SRK3X85	40	3	10	19	104.1	85	64.15	10	16	M6	M16	3
DIN6987140SRK4X50	40	4	10	15	69.1	50	35.55	12	18	M6	M16	3
DIN6987140SRK4X85	40	4	10	19	104.1	85	64.15	12	18	M6	M16	3
DIN6987140SRK5X50	40	5	10	15	69.1	50	35.55	15	21	M6	M16	3
DIN6987140SRK5X85	40	5	10	19	104.1	85	64.15	12	18	M6	M16	3
DIN6987140SRK6X50	40	6	11	16	69.1	50	35.55	18	24	M8	M16	4
DIN6987140SRK6X85	40	6	11	20	104.1	85	64.1	18	24	M8	M16	4
DIN6987140SRK8X50	40	8	14	20	69.1	50	42.5	25	31	M10	M16	5
DIN6987140SRK8X85	40	8	14	23	104.1	85	63.95	25	31	M10	M16	5
DIN6987140SRK10X50	40	10	16	22	69.1	50	42.4	30	36	M12	M16	6
DIN6987140SRK10X85	40	10	16	24.5	104.1	85	60.28	30	36	M12	M16	6
DIN6987140SRK12X50	40	12	20	26	69.1	50	42.3	32	42	M10	M16	5
DIN6987140SRK12X85	40	12	20	28	104.1	85	56.6	32	42	M10	M16	5

- Applicable for 10 MPa coolant
- Please use an induction heating unit for SRKIN holder.
- (1) Balanced to G2.5 max.n: 20,000 min⁻¹

Reference pages

Pull stud
K147Induction heating unit
K143Heating unit
K143Preset screw
K152

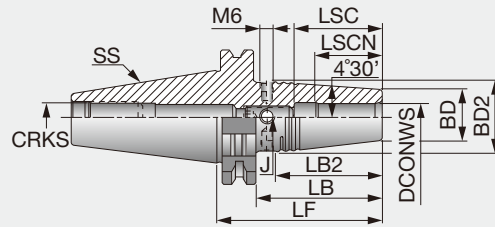

Designation	SS	DCONWS	BD	BD2	LF	LB	LB2	LSCN	LSC	J	CRKS	Wrench
DIN6987140SRKIN6X80	40	6	21	27	80	60.9	38	25	36	M5	M16	2.5
DIN6987140SRKIN8X80	40	8	21	27	80	60.9	38	25	36	M6	M16	3
DIN6987140SRKIN10X80	40	10	24	32	80	60.9	50.5	31	42	M8	M16	4
DIN6987140SRKIN12X80	40	12	24	32	80	60.9	50.5	31	47	M10	M16	5
DIN6987140SRKIN14X80	40	14	27	34	80	60.9	44.2	36	47	M10	M16	5
DIN6987140SRKIN16X80	40	16	27	34	80	60.9	44.2	39	50	M12	M16	6
DIN6987140SRKIN18X80	40	18	33	42	80	60.9	57	39	50	M12	M16	6
DIN6987140SRKIN20X80	40	20	33	42	80	60.9	57	41	52	M16	M16	8
DIN6987140SRKIN25X100	40	25	44	53	100	80.9	57	47	58	M16	M16	8
DIN6987150SRKIN6X80 ⁽¹⁾	50	6	21	27	80	60.9	38	25	36	M5	M24	2.5
DIN6987150SRKIN8X80 ⁽¹⁾	50	8	21	27	80	60.9	38	25	36	M6	M24	3
DIN6987150SRKIN10X80 ⁽¹⁾	50	10	24	32	80	60.9	51	31	42	M8	M24	4
DIN6987150SRKIN12X80 ⁽¹⁾	50	12	24	32	80	60.9	51	36	47	M10	M24	5
DIN6987150SRKIN14X80 ⁽¹⁾	50	14	27	34	80	60.9	44.5	36	47	M10	M24	5
DIN6987150SRKIN16X80 ⁽¹⁾	50	16	27	34	80	60.9	44.5	39	50	M12	M24	6
DIN6987150SRKIN18X80 ⁽¹⁾	50	18	33	42	80	60.9	57	39	50	M12	M24	6
DIN6987150SRKIN20X80 ⁽¹⁾	50	20	33	42	80	60.9	57	41	52	M16	M24	8
DIN6987150SRKIN25X100 ⁽¹⁾	50	25	44	53	100	80.9	57	47	58	M16	M24	8
DIN6987150SRKIN32X100 ⁽¹⁾	50	32	44	53	100	80.9	57	47	58	M16	M24	8

- Applicable for 10 MPa coolant
- Please use an induction heating unit for SRKIN holder
- (1) Balanced to G2.5 max.n: 20,000 min⁻¹

DIN69871 -SEM

Shell mill holder (DIN69871)

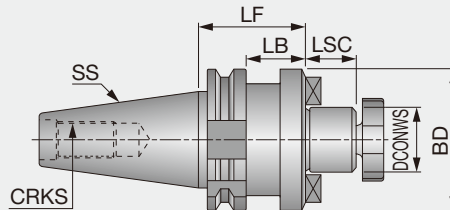

Designation	SS	DCONWS	LSC	BD	LF	LB	CRKS
DIN6987130SEM16X35	30	16	17	38	35	15.9	M12
DIN6987130SEM22X50	30	22	19	47	50	30.9	M12
DIN6987130SEM27X50	30	27	21	58	50	30.9	M12
DIN6987140SEM16X35	40	16	17	38	35	15.9	M16
DIN6987140SEM22X35	40	22	19	47	35	15.9	M16
DIN6987140SEM27X60	40	27	21	58	60	40.9	M16
DIN6987140SEM32X60	40	32	24	66	60	40.9	M16
DIN6987140SEM40X60	40	40	27	82	60	40.9	M16
DIN6987150SEM16X35	50	16	17	38	35	15.9	M24
DIN6987150SEM22X35	50	22	19	47	35	15.9	M24
DIN6987150SEM22X50X200	50	22	19	50	200	180.9	M24
DIN6987150SEM27X35	50	27	21	58	35	15.9	M24
DIN6987150SEM32X35	50	32	24	66	35	15.9	M24
DIN6987150SEM32X78X370	50	32	24	78	370	350.9	M24
DIN6987150SEM40X50	50	40	27	82	50	30.9	M24
DIN6987150SEM50X60	50	50	30	95	60	40.9	M24

Option: Wrench for center bolt

Reference pages

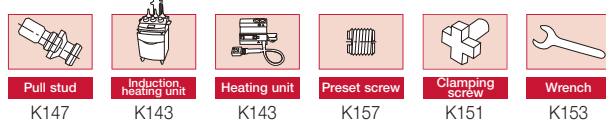

DIN69871-FM

Face mill holder (DIN69871)

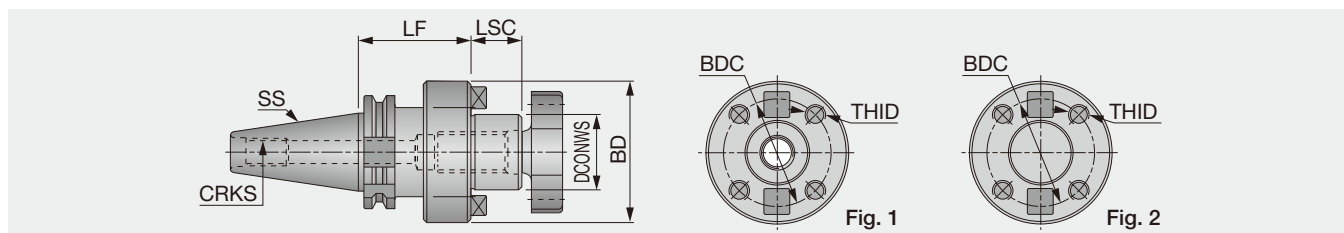

Designation	SS	DCONWS	LSC	BD	LF	BDC	THID	CRKS	Fig.
DIN6987140FM40	40	40	27	88	60	66.7	M12	M16	1
DIN6987150FM40	50	40	27	88	70	66.7	M12	M24	1
DIN6987150FM60	50	60	40	128	70	101.6	M16	M24	2

DIN69871-SEM

Shell mill holder with coolant hole, long type (DIN69871)

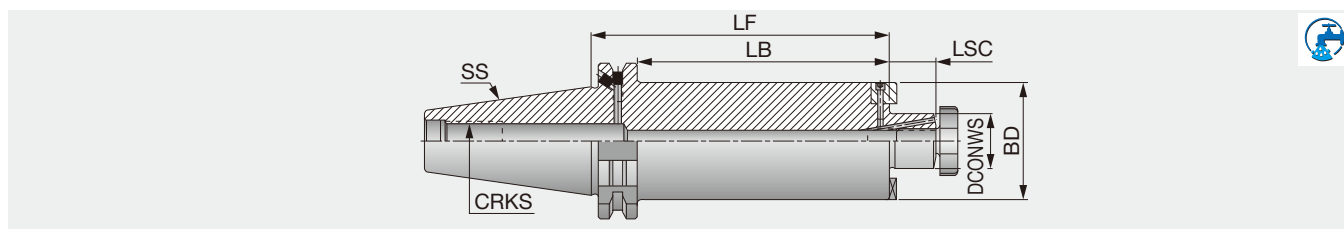

Designation	SS	DCONWS	LSC	BD	LF	LB	CRKS
DIN6987150SEM22X48X200C	50	22	19	48	200	181	M24
DIN6987150SEM22X61X300C	50	22	19	61	300	281	M24
DIN6987150SEM27X61X300C	50	27	21	61	300	281	M24
DIN6987150SEM32X78X370C	50	32	24	78	370	351	M24

- Applicable for 10 MPa coolant
- When being used as a flange-through type, the plug screw must be removed from the flange with a 2-mm hex key.

Option: Wrench for center bolt

Side lock

Collet chuck

Face mill

Milling chuck

Hydro chuck

Shrinking chuck

Others

Reference pages

Pull stud
K147Clamping screw
K151Wrench
K153

DIN69871-SEMC

Combination holder for slot mill and shell mill (DIN69871)

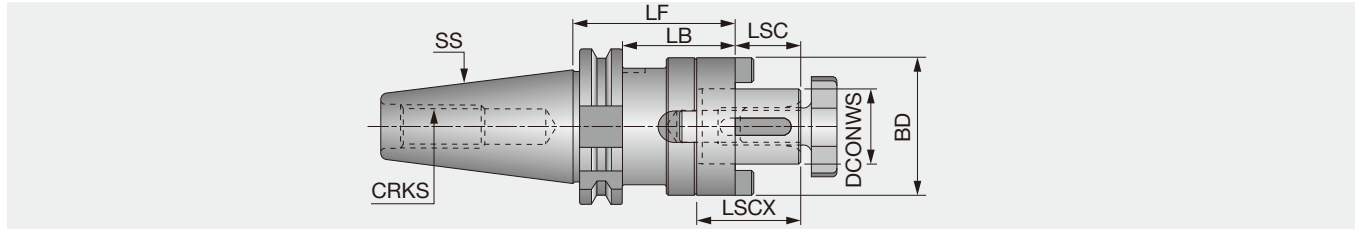

Designation	SS	DCONWS	LSC	BD	LF	LB	LSCX	CRKS
DIN6987130SEMC16X50	30	16	17	32	50	30.9	27	M12
DIN6987130SEMC22X50	30	22	19	40	50	30.9	31	M12
DIN6987140SEMC16X55	40	16	17	32	55	35.9	27	M16
DIN6987140SEMC16X100	40	16	17	32	100	80.9	27	M16
DIN6987140SEMC22X55	40	22	19	40	55	35.9	31	M16
DIN6987140SEMC22X100	40	22	19	40	100	80.9	31	M16
DIN6987140SEMC27X55	40	27	21	48	55	35.9	33	M16
DIN6987140SEMC27X100	40	27	21	48	100	80.9	33	M16
DIN6987140SEMC32X60	40	32	24	58	60	45.9	38	M16
DIN6987140SEMC32X100	40	32	24	58	100	80.9	38	M16
DIN6987140SEMC40X60	40	40	27	70	60	40.9	41	M16
DIN6987150SEMC16X55	50	16	17	32	55	35.9	27	M24
DIN6987150SEMC16X100	50	16	17	32	100	80.9	27	M24
DIN6987150SEMC22X55	50	22	19	40	55	35.9	31	M24
DIN6987150SEMC22X100	50	22	19	40	100	80.9	31	M24
DIN6987150SEMC27X55	50	27	21	48	55	35.9	33	M24
DIN6987150SEMC27X100	50	27	21	48	100	80.9	33	M24
DIN6987150SEMC32X55	50	32	24	58	55	35.9	38	M24
DIN6987150SEMC32X100	50	32	24	58	100	80.9	38	M24
DIN6987150SEMC40X55	50	40	27	70	55	35.9	41	M24
DIN6987150SEMC40X100	50	40	27	70	100	80.9	41	M24
DIN6987150SEMC50X70	50	50	30	90	70	50.9	46	M24

Option: Wrench for center bolt

DIN69871-DC

Jacobs taper holder (DIN69871)

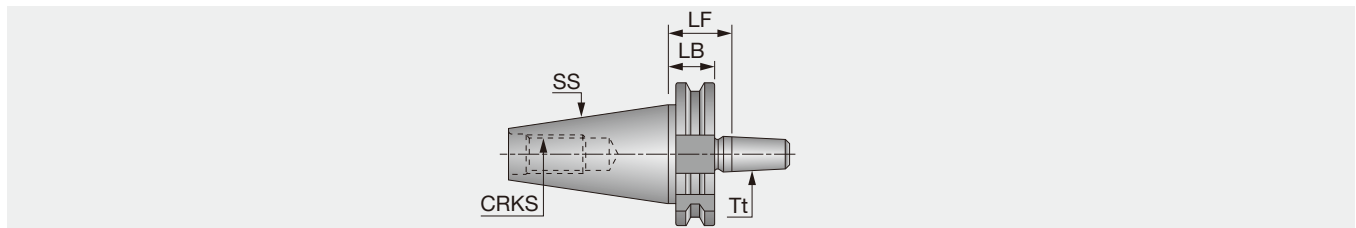

Designation	SS	Tt	LF	LB	CRKS
DIN6987140DCB12X26	40	B12	26	19.1	M16
DIN6987140DCB16X26	40	B16	26	19.1	M16
DIN6987140DCB18X26	40	B18	26	19.1	M16
DIN6987150DCB16X26	50	B16	26	19.1	M24
DIN6987150DCB18X26	50	B18	26	19.1	M24

Reference pages

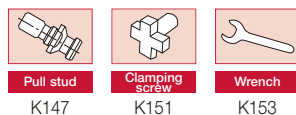

DIN69871 AD

Conversion adapter (DIN69871)

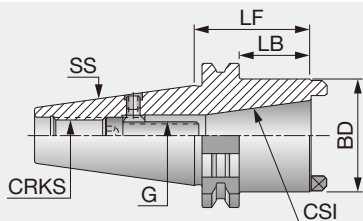

Designation	SS	CSI	LF	BD	LB	G	CRKS
DIN6987140ADDIN208030	40	DIN2080 30	50	50	30.9	M12	M16
DIN6987150ADBT/SK40	50	BT/SK 40	70	66	50.9	M16	M24

DIN69871 -MT

Morse taper holder (DIN69871)

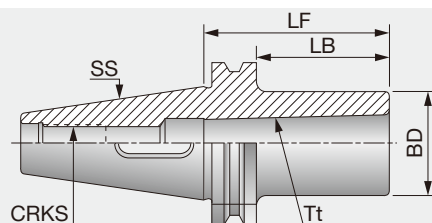

Designation	SS	Tt	LF	BD	LB	CRKS
DIN6987140MT1X50	40	MT1	50	25	30.9	M16
DIN6987140MT2X50	40	MT2	50	32	30.9	M16
DIN6987140MT3X70	40	MT3	70	40	50.9	M16
DIN6987140MT4X95	40	MT4	95	48	75.9	M16
DIN6987150MT1X45	50	MT1	45	25	25.9	M24
DIN6987150MT2X60	50	MT2	60	32	40.9	M24
DIN6987150MT3X65	50	MT3	65	40	45.9	M24
DIN6987150MT4X95	50	MT4	95	48	75.9	M24
DIN6987150MT5X105	50	MT5	105	63	85.9	M24

Side lock

Collet chuck

Face mill

Milling chuck

Hydro chuck

Shrinking chuck

Others

Reference pages



Pull stud

K147

DIN69871-MT DRW

Morse taper holder with draw bar (DIN69871)

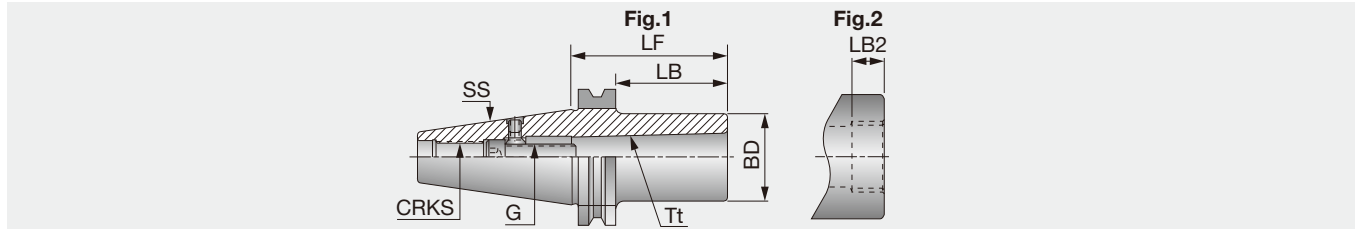

Designation	SS	Tt	LF	BD	LB	LB2	G	CRKS	Fig.
DIN6987140MT1DRW	40	MT1	50	25	30.9	-	M6	M16	1
DIN6987140MT2DRW	40	MT2	50	32	30.9	-	M10	M16	1
DIN6987140MT3DRW	40	MT3	70	40	50.9	-	M12	M16	1
DIN6987140MT4DRW ⁽¹⁾	40	MT4	95	63	75.9	15	M16	M16	2
DIN6987150MT1DRW	50	MT1	45	25	25.9	-	M6	M24	1
DIN6987150MT2DRW	50	MT2	60	32	40.9	-	M10	M24	1
DIN6987150MT3DRW	50	MT3	65	40	45.9	-	M12	M24	1
DIN6987150MT4DRW ⁽¹⁾	50	MT4	70	63	50.9	15	M16	M24	2
DIN6987150MT5DRW ⁽¹⁾	50	MT5	100	78	80.9	18	M20	M24	2

(1) DIN 2201.

Reference pages



Pull stud

K147

Grade
Insert
Toolholder
Ext. Toolholder
Int. Toolholder
Threading
Grooving
Miniature tool
Milling cutter
Endmill
Drilling tool
Tooling System
User's Guide
Index

A
B
C
D
E
F
G
H
I
J
K
L
M

TUNGFINE

ADJ DIN69871-ER collet

ER collet chuck holder with center alignment (DIN69871)

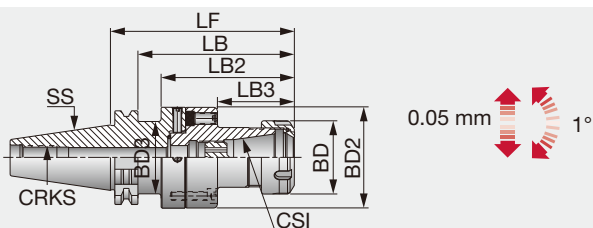

Designation	SS	CSI	Range	LF	LB	LB2	LB3	BD	BD2	BD3	CRKS
ADJDIN6987140D70ER32	40	ER32	2-20	124.5	105.4	89.5	52.5	50	70	46	M16
ADJDIN6987150D70ER32	50	ER32	2-20	124.5	105.4	-	52.5	50	70	-	M24

• Applicable for 10 MPa coolant

Option: Wrench for ER collet

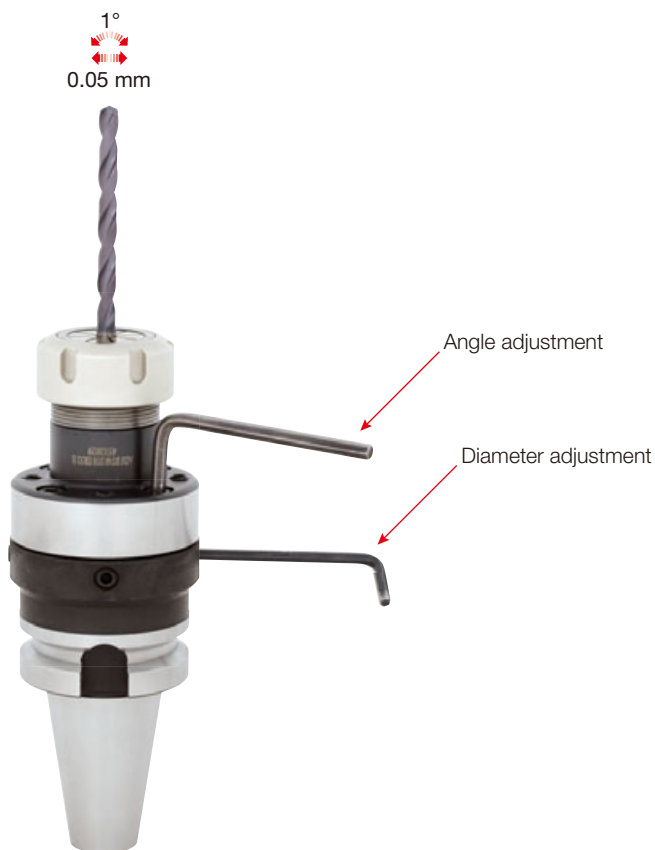
DIN
69871

HSK

BT
MASDIN
2080

Others

Side
lockCollet
chuckFace
millMilling
chuckHydro
chuckShrinking
chuck

Others

Reference pages



ER collet

K124 -



Nut

K148



Wrench

K150



Preset screw

K151



Pull stud

K147

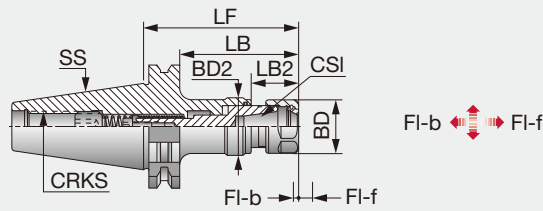

Designation	SS	CSI	Tap min	Tap max	Range	LF	LB	LB2	BD	BD2	FI-f	FI-b	CRKS
GTIDIN6987140ER16	40	ER16	M3	M10	0.5-10	81.2	62.1	24.6	28	29.5	8	3	M16
GTIDIN6987150ER16	50	ER16	M3	M10	0.5-10	106.8	87.7	24.6	28	29.5	8	3	M24
GTIDIN6987140ER32	40	ER32	M6	M20	2-20	112.6	93.5	33	50	56.5	9	4	M16
GTIDIN6987150ER32	50	ER32	M6	M20	2-20	115.3	96.2	33	50	56.5	9	4	M24
GTIDIN6987140ER40	40	ER40	M6	M28	3-26	130.6	111.5	51	63	56.5	9	4	M16
GTIDIN6987150ER40	50	ER40	M6	M28	3-26	133.3	114.2	51	63	56.5	9	4	M24

Option: Wrench for ER collet

TUNG^{FIT}

DIN69871-CF

Quick change holder (DIN69871)

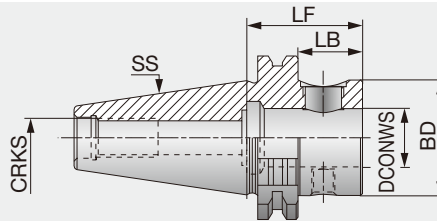

Designation	SS	DCONWS	BD	LF	LB	CRKS
DIN6987140CF4-S	40	25	44.5	44.1	25	M16
DIN6987140CF4-L	40	25	44.5	100	80.9	M16
DIN6987150CF4-S	50	25	44.5	44.1	25	M24
DIN6987150CF4-L	50	25	44.5	100	80.9	M24
DIN6987150CF4-LB	50	25	44.5	100	80.9	M24

- Applicable for 10 MPa coolant
- Clamping torque: 58.8 N·m Add B at the end of the designation for the item with coolant through the flange.

TUNG^{CLICK}

DIN69871-ER-CLICK

Quick change holder (DIN69871)

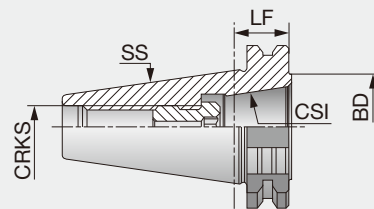

Designation	SS	CSI	BD	LF	CRKS
DIN6987140ER32CLICK-IN	40	ER32	41	20.1	M16

- Applicable for 10 MPa coolant • Clamping torque: 235 N·m

Reference pages

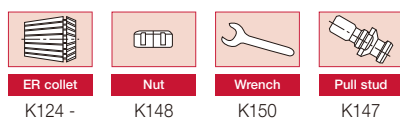

K124 -

K148

K150

K147

TUNGFLEX

DIN69871-ODP

Screw-clamp holder for modular heads (DIN69871)

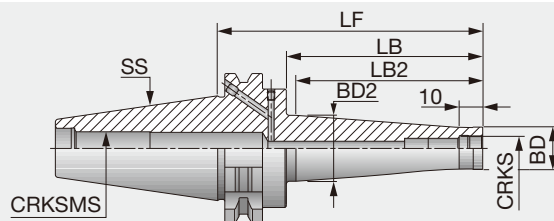

Designation	SS	CRKS	BD	BD2	LF	LB	LB2	CRKSMS
DIN6987140ODP6X58	40	M6	9.8	13	58	38.9	32	M16
DIN6987140ODP6X98	40	M6	9.8	23	98	78.9	74	M16
DIN6987140ODP8X58	40	M8	13.1	15	58	38.9	32	M16
DIN6987140ODP8X98	40	M8	13.1	23	98	78.9	74	M16
DIN6987140ODP10X58	40	M10	18	20	58	38.9	32	M16
DIN6987140ODP10X98	40	M10	18	28	98	78.9	74	M16
DIN6987140ODP12X58	40	M12	21	24	58	38.9	34	M16
DIN6987140ODP12X98	40	M12	21	31	98	78.9	75	M16
DIN6987140ODP16X58	40	M16	29	28.6	58	38.9	33	M16
DIN6987140ODP16X98	40	M16	29	34	98	78.9	75	M16
DIN6987150ODP12X78 ⁽¹⁾	50	M12	23	30	78	58.9	50	M24
DIN6987150ODP12X128 ⁽¹⁾	50	M12	23	40	128	108.9	100	M24
DIN6987150ODP12X178 ⁽¹⁾	50	M12	23	40	178	158.9	150	M24
DIN6987150ODP12X228 ⁽¹⁾	50	M12	23	46	228	208.9	200	M24
DIN6987150ODP16X78 ⁽¹⁾	50	M16	29	34	78	58.9	50	M24
DIN6987150ODP16X128 ⁽¹⁾	50	M16	29	40	128	108.9	100	M24
DIN6987150ODP16X178 ⁽¹⁾	50	M16	29	55	178	158.9	150	M24
DIN6987150ODP16X228 ⁽¹⁾	50	M16	29	55	228	208.9	200	M24

- Applicable for 10 MPa coolant
- (1) Balanced to G6.3 max.n: 12,000 min⁻¹

Reference pages



Pull stud

K146

HSK E-ER

ER collet chuck holder (HSK-E)

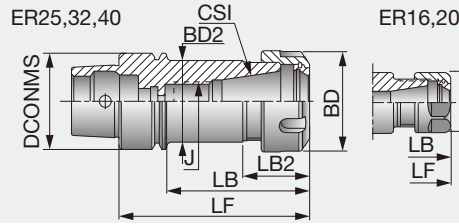

Designation	Range								
	DCONMS	CSI		LF	LB	LB2	BD	BD2	J
HSKE32ER16X60	32	ER16	0.5-10	60	40	21.5	28	22.4	-
HSKE32ER20X60	32	ER20	1-13	6	40	26	34	25.4	-
HSKE32ER25X65	32	ER25	1-16	65	45	30	42	25.8	-
HSKE40ER16X60	40	ER16	0.5-10	60	40	-	28	-	-
HSKE40ER16X80	40	ER16	0.5-10	80	60	-	28	-	M10
HSKE40ER20X80	40	ER20	1-13	80	60	-	34	-	M12
HSKE40ER25X80	40	ER25	1-16	80	60	28	42	34	M18X1.5
HSKE40ER32X80	40	ER32	2-20	80	60	31	50	40.1	M22X1.5
HSKE50ER16X100 ⁽¹⁾	50	ER16	0.5-10	100	74	-	28	-	M10
HSKE50ER16X100M ⁽¹⁾⁽³⁾	50	ER16	0.5-10	100	74	-	22	-	M10
HSKE50ER16X80 ⁽¹⁾	50	ER16	0.5-10	80	54	-	28	-	M10
HSKE50ER20X80 ⁽¹⁾	50	ER20	1-13	80	54	-	34	-	M10
HSKE50ER25X80 ⁽¹⁾	50	ER25	1-16	80	54	28	42	32.4	-
HSKE50ER32X80 ⁽¹⁾	50	ER32	2-20	80	54	31	50	40.4	-
HSKE50ER32X100 ⁽¹⁾	50	ER32	2-20	100	74	31	50	40.4	M22X1.5
HSKE63ER16X80 ⁽²⁾	63	ER16	0.5-10	80	54	-	28	-	M10
HSKE63ER16X100 ⁽²⁾	63	ER16	0.5-10	100	74	-	28	-	M10
HSKE63ER20X75 ⁽²⁾	63	ER20	1-13	75	49	-	34	-	-
HSKE63ER32X100 ⁽²⁾	63	ER32	2-20	100	75	-	50	-	M22X1.5

- Applicable for 10 MPa coolant
- Equipped with nut ER 16 MINI
- (1) Balanced to G2.5 max.n: 35,000 min⁻¹
- (2) Balanced to G2.5 max.n: 35,000 min⁻¹
- (3) Balanced to G2.5 max.n: 30,000 min⁻¹

Option: Wrench for ER collet

HSK A-ER M

ER Mini collet chuck holder (HSK-A)

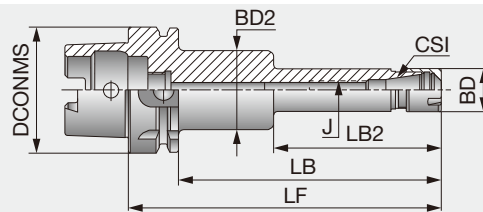

Designation	Range								
	DCONMS	CSI		LF	LB	LB2	BD	BD2	J
HSKA63ER16X100M	63	ER16	0.5-10	100	74	-	22	-	M10
HSKA63ER16X120M	63	ER16	0.5-10	120	94	78	22	40	M10
HSKA63ER16X160M	63	ER16	0.5-10	160	134	85	22	40	M10
HSKA63ER20X100M	63	ER20	1-13	100	74	-	28	-	M12
HSKA63ER20X120M	63	ER20	1-13	120	94	-	28	-	M12
HSKA63ER20X160M	63	ER20	1-13	160	134	85	28	45	M12
HSKA100ER16X100M ⁽¹⁾	100	ER16	0.5-10	100	71	-	22	-	M10
HSKA100ER16X160M ⁽¹⁾	100	ER16	0.5-10	160	131	85	22	40	M10
HSKA100ER20X100M ⁽¹⁾	100	ER20	1-13	100	71	-	28	-	M12
HSKA100ER20X160M ⁽¹⁾	100	ER20	1-13	160	131	85	28	45	M12

- Applicable for 10 MPa coolant
- (1) Balanced to G6.3 max.n: 12,000 min⁻¹

Option: Wrench for ER collet

Reference pages



K124 - K148, K149 K151 K150, K154 K153

HSK A-ER

ER collet chuck holder (HSK-A)

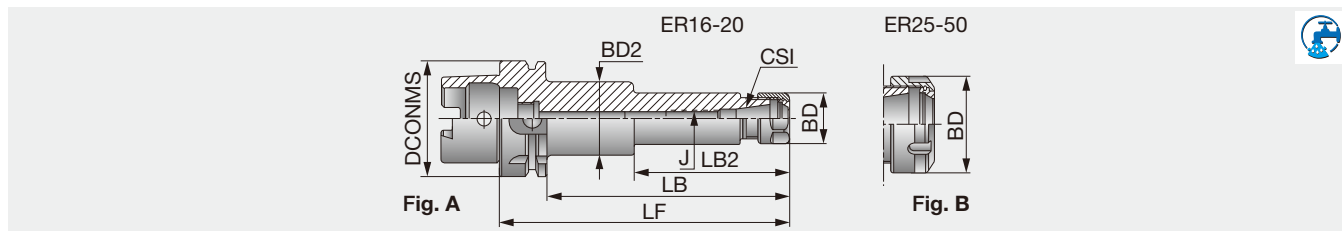

Designation	DCONMS	CSI	Range	LF	LB	LB2	BD	BD2	J	Fig.
HSKA40ER16X60	40	ER16	0.5-10	60	40	-	28	-	M10	A
HSKA40ER16X80	40	ER16	0.5-10	80	60	-	28	-	M10	A
HSKA50ER20X100	50	ER20	1-13	100	74	-	34	-	M12	A
HSKA63ER16X100	63	ER16	0.5-10	100	74	-	28	-	M10	A
HSKA63ER16X120	63	ER16	0.5-10	120	94	-	28	-	M10	A
HSKA63ER16X160	63	ER16	0.5-10	160	134	85.6	28	40	M10	A
HSKA63ER20X100	63	ER20	1-13	100	74	-	34	-	M12	A
HSKA63ER20X120	63	ER20	1-13	120	94	-	34	-	M12	A
HSKA63ER20X160	63	ER20	1-13	160	134	85.0	34	45	M12	A
HSKA100ER16X100 ⁽¹⁾	100	ER16	0.5-10	100	71	-	28	-	M10	A
HSKA100ER16X160 ⁽¹⁾	100	ER16	0.5-10	160	131	85	28	40	M10	A
HSKA100ER20X100 ⁽¹⁾	100	ER20	1-13	100	71	-	34	-	M12	A
HSKA100ER20X160 ⁽¹⁾	100	ER20	1-13	160	131	85	34	45	M12	A
HSKA40ER25X80	40	ER25	1-16	80	60	28	42	32.4	M18x1.5	B
HSKA40ER25X100	40	ER25	1-16	100	80	28	42	32.4	M16	B
HSKA40ER32X100	40	ER32	2-20	100	80	31	50	40.4	M22x1.5	B
HSKA63ER25X80	63	ER25	1-16	80	54	-	42	-	M16	B
HSKA63ER25X100	63	ER25	1-16	100	74	-	42	-	M16	B
HSKA63ER25X120	63	ER25	1-16	120	94	-	42	-	M16	B
HSKA63ER25X160	63	ER25	1-16	160	134	-	42	-	M16	B
HSKA63ER32X80	63	ER32	2-20	80	54	31	50	40.4	M22x1.5	B
HSKA63ER32X100	63	ER32	2-20	100	74	-	50	-	M22x1.5	B
HSKA63ER32X120	63	ER32	2-20	120	94	-	50	-	M22x1.5	B
HSKA63ER32X140	63	ER32	2-20	140	114	-	50	-	M22x1.5	B
HSKA63ER32X160	63	ER32	2-20	160	134	-	50	-	M22x1.5	B
HSKA63ER40X80	63	ER40	3-26	80	54	34	63	50.4	-	B
HSKA63ER40X100	63	ER40	3-26	100	74	34	63	50.4	M28x1.5	B
HSKA63ER40X120	63	ER40	3-26	120	94	34	63	50.4	M28x1.5	B
HSKA100ER25X100	100	ER25	1-16	100	71	-	42	-	M16	B
HSKA100ER25X120	100	ER25	1-16	120	91	-	42	-	M16	B
HSKA100ER25X160	100	ER25	1-16	160	134	-	42	-	M16	B
HSKA100ER32X100	100	ER32	2-20	100	71	-	50	-	M22x1.5	B
HSKA100ER32X120	100	ER32	2-20	120	91	-	50	-	M22x1.5	B
HSKA100ER32X160	100	ER32	2-20	160	131	-	50	-	M22x1.5	B
HSKA100ER40X100	100	ER40	3-26	100	71	-	63	-	M28x1.5	B
HSKA100ER40X120	100	ER40	3-26	120	91	-	63	-	M28x1.5	B
HSKA100ER40X160	100	ER40	3-26	160	131	-	63	-	M28x1.5	B
HSKA100ER50X100	100	ER50	10-34	100	71	-	78	-	-	B

• Applicable for 10 MPa coolant
(1) Balanced to G6.3 max.n: 12,000 min⁻¹

Option: Wrench for ER collet

Reference pages



ER collet

K124 -



Nut

K148



Preset screw

K151



Wrench

K150, K154



Cooling tube

K153

HSK FM-ER

ER collet chuck holder (HSK-FM)

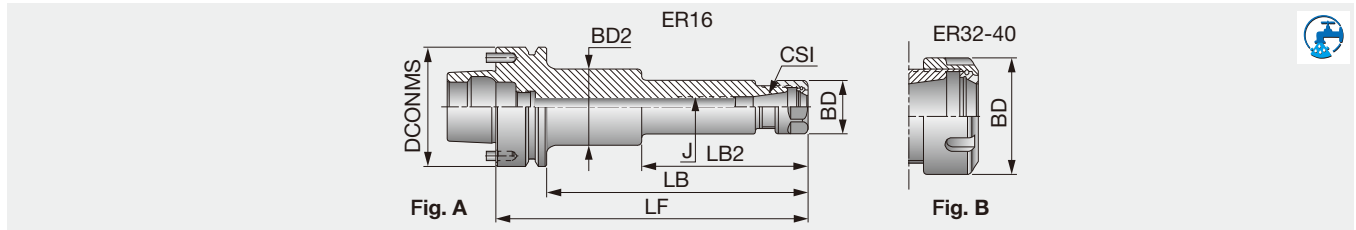

Designation	DCONMS	CSI	Range	LF	LB	LB2	BD	BD2	J	Fig.
HSKFM63ER16X80	63	ER16	0.5-10	80	54	-	28	-	M10	A
HSKFM63ER16X100	63	ER16	0.5-10	100	74	-	28	-	M10	A
HSKFM63ER16X120	63	ER16	0.5-10	120	94	-	28	-	M10	A
HSKFM63ER16X160	63	ER16	0.5-10	160	134	85.6	28	40	M10	A
HSKFM63ER32X80	63	ER32	2-20	80	54	-	50	-	-	B
HSKFM63ER32X100	63	ER32	2-20	100	74	-	50	-	M22x1.5	B
HSKFM63ER40X80	63	ER40	3-26	80	54	32	63	50	-	B
HSKFM63ER40X100	63	ER40	3-26	100	74	32	63	50	M28x1.5	B

- Applicable for 10 MPa coolant
- The driving pins can be removed, turning the toolholder into a standard HSK F63 type.

Option: Wrench for ER collet

TUNGSHORT HSK A-SHORT

ER collet chuck holder, short type (HSK-A)

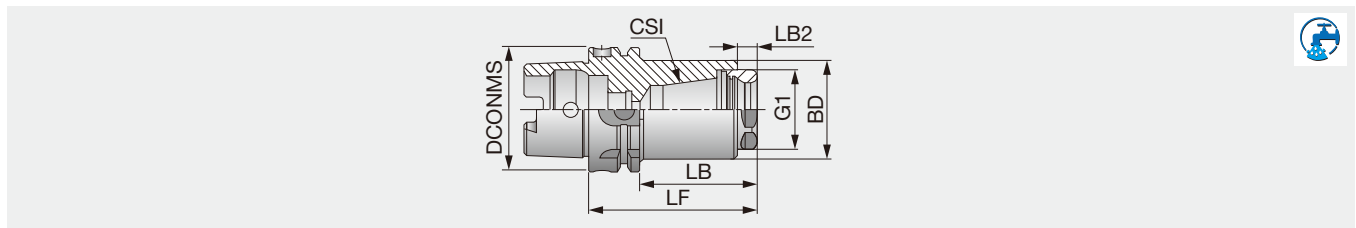

Designation	DCONMS	CSI	Range	LF	LB	LB2	BD	G1
HSKA63ER32SHORT	63	ER32	2-20	84.5	56.1	9.5	50	M40x1.5
HSKA100ER32SHORT	100	ER32	2-20	89.5	60.5	9.5	50	M40x1.5
HSKA100ER40SHORT	100	ER40	3-26	104.5	75.5	9.5	70	M50x1.5

- Applicable for 10 MPa coolant
- Balanced to G6.3 max.n: 8,000 min⁻¹

Option: Wrench for ER collet

TUNGMAX HSK A-TUNGMAX

Power chuck holder (HSK-A)

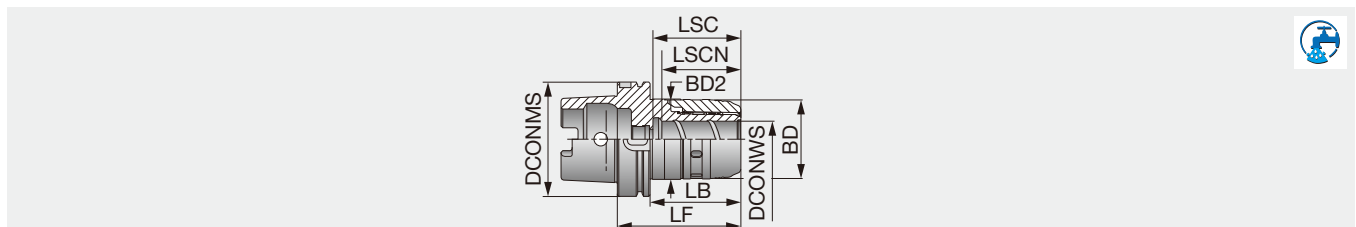

Designation	DCONMS	DCONWS	Range	LF	LB	LSCN	LSC	BD	BD2
HSKA63MAXIN20X95	63	20	6-20	95	69	56	66	51	53
HSKA63MAXIN32X113	63	32	6-32	113	87	70	85	69	70
HSKA100MAXIN20X115 ⁽¹⁾	100	20	6-20	115	86	56	69	51	53
HSKA100MAXIN32X135 ⁽¹⁾	100	32	6-32	135	106	71	87	69	70

- Applicable for 10 MPa coolant
- (1) Balanced to G6.3 max.n: 8,000 min⁻¹

Option: Wrench for TungMax collet

Reference pages

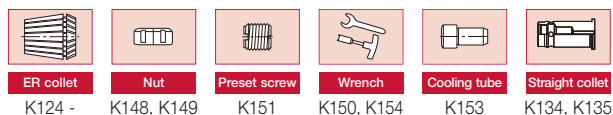

ER collet K124 - Nut K148, K149 Preset screw K151 Wrench K150, K154 Cooling tube K153 Straight collet K134, K135



TUNGBALANCE

HSK A-TUNGMAX BIN

Power chuck holder with adjustable dynamic balance (HSK-A)

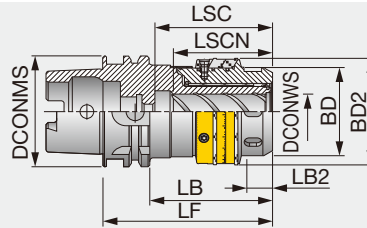

Designation	DCONMS	DCONWS	Range	LF	LB	LB2	LSCN	LSC	BD	BD2
HSKA63MAXIN20X95BIN ⁽¹⁾	63	20	6-20	95	69	17.5	56	66	51	61
HSKA63MAXIN32X113BIN ⁽¹⁾	63	32	6-32	113	87	24.9	70	85	69	80

• Applicable for 10 MPa coolant

Option: Wrench for TungMax collet

(1) Chucks with taper size HSK A63 can be balanced by the balancing ring up to G2.5 at 20,000 min⁻¹.
 (2) Chucks with taper size HSK A100 can be balanced by the balancing ring up to G2.5 at 18,000 min⁻¹.

HSK A-ER BIN

ER collet chuck holder with adjustable dynamic balance (HSK-A)

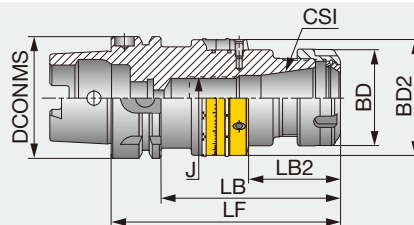

Designation	DCONMS	CSI	Range	LF	LB	LB2	BD	BD2	J
HSKA63ER32X120BIN	63	ER32	2-20	120	94	48	50	60	M22x1.5

• Applicable for 10 MPa coolant

Option: Wrench for ER collet

(1) Balanced to G2.5 max.n: 20,000 min⁻¹

Reference pages



ER collet

K124 -



Nut

K149



Preset screw

K151



Wrench

K150, K154



Cooling tube

K153



Straight collet

K134, K135

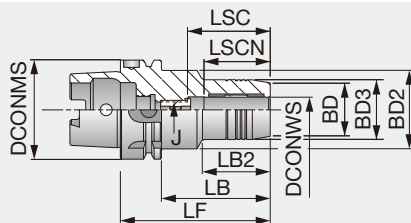

Designation	DCONMS	DCONWS	BD3	BD	BD2	LF	LB	LB2	LSCN	LSC	J
HSKA50HYDRO6X80	50	6	26	23	42	80	54	35	27	37	M5
HSKA50HYDRO8X80	50	8	28	25	42	80	54	36	27	37	M6
HSKA50HYDRO16X95	50	16	38	34	42	95	69	52	42	52	M12x1
HSKA50HYDRO20X100	50	20	42	38	42	100	74	74	42	52	M16x1
HSKA63HYDRO6X80	63	6	26	23	50	80	54	33	27	37	M5
HSKA63HYDRO8X80	63	8	28	25	50	80	54	33	27	37	M6
HSKA63HYDRO10X85	63	10	30	27	50	85	59	39	32	42	M8x1
HSKA63HYDRO12X90	63	12	32	29	50	90	64	44	37	47	M10x1
HSKA63HYDRO14X90	63	14	34	30	50	90	64	46	37	47	M10x1
HSKA63HYDRO16X95	63	16	38	34	50	95	69	52	42	52	M12x1
HSKA63HYDRO18X95	63	18	40	36	50	95	69	52	42	52	M12x1
HSKA63HYDRO20X100	63	20	42	38	50	100	74	58	42	52	M16x1
HSKA63HYDRO25X120	63	25	50	46	50	120	94	94	48	58	M16x1
HSKA63HYDRO32X125	63	32	60	56	53	125	99	83	52	62	M16x1
HSKA80HYDRO6X85	80	6	26	23	50	85	59	37	27	37	M5
HSKA80HYDRO14X95	80	14	34	30	50	95	69	47	37	47	M10x1
HSKA80HYDRO16X100	80	16	38	34	50	100	74	52	42	52	M12x1
HSKA80HYDRO18X100	80	18	40	36	50	100	74	52	42	52	M12x1
HSKA80HYDRO20X105	80	20	42	38	50	105	79	52	42	52	M16x1
HSKA80HYDRO25X115	80	25	50	46	50	115	89	58	48	58	M16x1
HSKA100HYDRO6X85	100	6	26	23	63	85	56	29	27	37	M5
HSKA100HYDRO8X85	100	8	28	25	63	85	56	29	27	37	M6
HSKA100HYDRO10X90	100	10	30	27	63	90	61	35	32	42	M8x1
HSKA100HYDRO12X95	100	12	32	29	63	95	66	40	37	47	M10x1
HSKA100HYDRO14X95	100	14	34	30	63	95	66	42	37	47	M10x1
HSKA100HYDRO16X100	100	16	38	34	63	100	71	47	42	52	M12x1
HSKA100HYDRO18X100	100	18	40	36	63	100	71	48	42	52	M12x1
HSKA100HYDRO20X105	100	20	42	38	63	105	76	54	42	52	M16x1
HSKA100HYDRO25X115	100	25	50	46	63	115	86	51	48	58	M16x1
HSKA100HYDRO32X120	100	32	60	56	63	120	91	59	52	62	M16x1

- Applicable for 10 MPa coolant
- Reduction sleeves are available for d = 12, 20, 25, and 32mm.
- Chucking force will reduce when using a reduction sleeve.

Option: Clamping wrench

Reference pages



Straight collet

K137



Cooling tube

K153



Wrench

K154

TUNGHYDRO

HSK A-HYDRO

Hydraulic endmill chuck holder, long type (HSK-A)

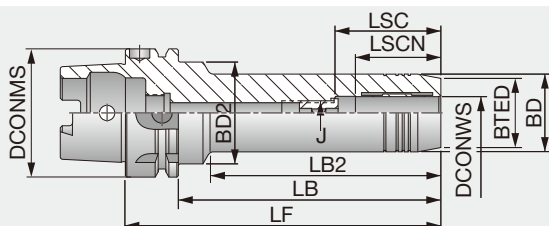

Designation	DCONMS	DCONWS	BD	BTED	BD2	LF	LB	LB2	LSCN	LSC	J
HSKA63HYDRO6X150	63	6	26	23	50	150	124	103	27	37	M5
HSKA63HYDRO6X200	63	6	26	23	50	200	174	153	27	37	M5
HSKA63HYDRO8X150	63	8	28	25	50	150	124	104	27	37	M6
HSKA63HYDRO10X150	63	10	30	27	50	150	124	104	32	42	M8x1
HSKA63HYDRO10X200	63	10	30	27	50	200	174	154	32	42	M8x1
HSKA63HYDRO12X150	63	12	32	29	50	150	124	105	37	47	M10x1
HSKA63HYDRO12X200	63	12	32	29	50	200	174	155	37	47	M10x1
HSKA63HYDRO14X150	63	14	34	30	50	150	124	105	37	47	M10x1
HSKA63HYDRO16X150	63	16	38	34	50	150	124	106.5	42	52	M12x1
HSKA63HYDRO16X200	63	16	38	34	50	200	174	156.5	42	52	M12x1
HSKA63HYDRO20X150	63	20	42	38	50	150	124	108	42	52	M12x1
HSKA63HYDRO20X200	63	20	42	38	50	200	174	158	42	52	M12x1
HSKA63HYDRO25X150	63	25	50	46	50	150	124	-	48	58	M16x1
HSKA63HYDRO25X200	63	25	50	46	50	200	174	-	48	58	M16x1
HSKA100HYDRO6X150	100	6	26	23	50	150	124	94	27	37	M6
HSKA100HYDRO6X200	100	6	26	23	50	200	174	144	27	37	M6
HSKA100HYDRO8X150	100	8	28	25	50	150	124	94.5	27	37	M6
HSKA100HYDRO8X200	100	8	28	25	50	200	174	144.5	27	37	M6
HSKA100HYDRO10X150	100	10	30	27	50	150	124	95	32	42	M8x1
HSKA100HYDRO10X200	100	10	30	27	50	200	174	145	32	42	M8x1
HSKA100HYDRO12X150	100	12	32	29	50	150	124	95.5	37	47	M10x1
HSKA100HYDRO12X200	100	12	32	29	50	200	174	145.5	37	47	M10x1
HSKA100HYDRO14X150	100	14	34	30	50	150	124	97	37	47	M10x1
HSKA100HYDRO14X200	100	14	34	30	50	200	174	147	37	47	M10x1
HSKA100HYDRO16X150	100	16	38	34	50	150	124	97.5	42	52	M12x1
HSKA100HYDRO16X200	100	16	38	34	50	200	174	147.5	42	52	M12x1
HSKA100HYDRO18X150	100	18	40	36	50	150	124	98	42	52	M12x1
HSKA100HYDRO18X200	100	18	40	36	50	200	174	148	42	52	M12x1
HSKA100HYDRO20X150	100	20	42	38	50	150	124	99	42	52	M12x1
HSKA100HYDRO20X200	100	20	42	38	50	200	174	149	42	52	M12x1
HSKA100HYDRO25X200	100	25	50	46	50	200	174	-	48	58	M16x1
HSKA100HYDRO32X200	100	32	60	56	60	200	174	-	52	62	M16x1

- Applicable for 10 MPa coolant
- Reduction sleeves are available for d = 12, 20, 25, and 32mm.
- Chucking force will reduce when using a reduction sleeve.

Option: Clamping wrench

Reference pages



Straight collet

K137



Cooling tube

K153



Wrench

K154

HSK A-EM

Side lock holder for weldon endmills (HSK-A)

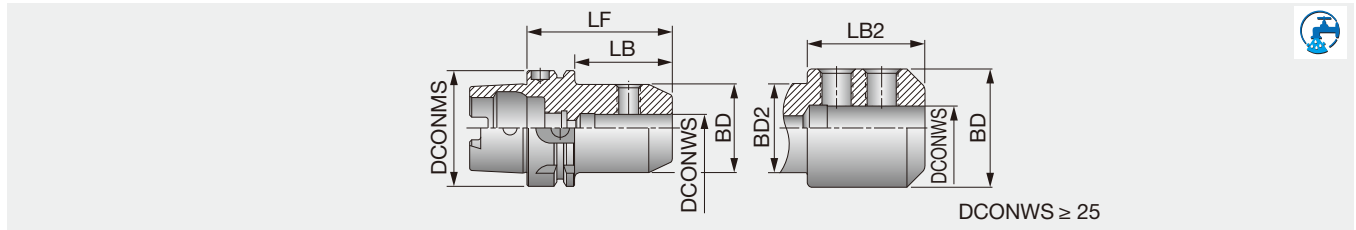

Designation	DCONMS	DCONWS	BD	BD2	LF	LB	LB2
HSKA63EM6X65	63	6	25	-	65	39	-
HSKA63EM8X65	63	8	28	-	65	39	-
HSKA63EM10X65	63	10	35	-	65	39	-
HSKA63EM12X80	63	12	42	-	80	54	-
HSKA63EM14X80	63	14	44	-	80	54	-
HSKA63EM16X80	63	16	48	-	80	54	-
HSKA63EM18X80	63	18	50	-	80	54	-
HSKA63EM20X80	63	20	52	-	80	54	-
HSKA63EM25X110	63	25	65	52	110	84	65.5
HSKA63EM32X110	63	32	72	52	110	84	65.5
HSKA100EM6X80	100	6	25	-	80	51	-
HSKA100EM8X80	100	8	28	-	80	51	-
HSKA100EM10X80	100	10	35	-	80	51	-
HSKA100EM12X80	100	12	42	-	80	51	-
HSKA100EM14X80	100	14	44	-	80	51	-
HSKA100EM16X100	100	16	48	-	100	71	-
HSKA100EM18X100	100	18	50	-	100	71	-
HSKA100EM20X100	100	20	52	-	100	71	-
HSKA100EM25X100	100	25	65	-	100	71	-
HSKA100EM32X100	100	32	72	-	100	71	-

• Applicable for 7 MPa coolant

HSK A-EM E

Side lock holder for whistle notch (HSK-A)

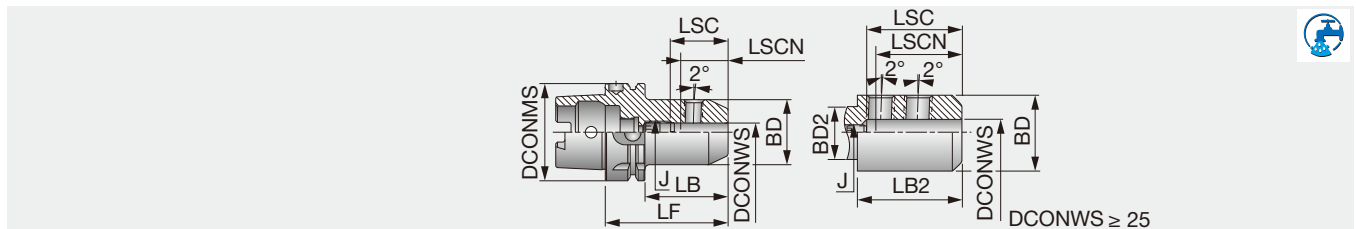

Designation	DCONMS	DCONWS	BD	BD2	LF	LB	LB2	LSCN	LSC	J	Wrench
HSKA63EM6X80E	63	6	25	-	80	54	-	32	40	M5	2
HSKA63EM8X80E	63	8	28	-	80	54	-	35	40	M6	3
HSKA63EM10X80E	63	10	35	-	80	54	-	39	44	M8	4
HSKA63EM12X90E	63	12	42	-	90	64	-	44	49	M10	5
HSKA63EM14X90E	63	14	44	-	90	64	-	44	49	M10	5
HSKA63EM16X100E	63	16	48	-	100	74	-	47	52	M12	6
HSKA63EM18X100E	63	18	50	-	100	74	-	47	55	M12	6
HSKA63EM20X100E	63	20	52	-	100	74	-	49	54	M16	8
HSKA63EM25X110E	63	25	65	52	110	84	65.5	54	61	M16	8
HSKA63EM32X110E	63	32	72	52	110	84	65.5	58	63	M20X1.5	10
HSKA100EM8X90E	100	8	28	-	90	61	-	35	40	M6	3
HSKA100EM12X100E	100	12	42	-	100	71	-	44	54	M10	5
HSKA100EM14X100E	100	14	44	-	100	71	-	44	54	M10	5
HSKA100EM16X100E	100	16	48	-	100	71	-	47	52	M12	6
HSKA100EM18X100E	100	18	50	-	100	71	-	47	52	M12	6
HSKA100EM20X110E	100	20	52	-	110	81	-	49	54	M16	8
HSKA100EM25X120E	100	25	65	-	120	91	-	54	61	M20X1.5	10
HSKA100EM32X120E	100	32	72	-	120	91	-	58	63	M20X1.5	10

• Applicable for 7 MPa coolant
The adjustment screw has an internal coolant hole.

Reference pages

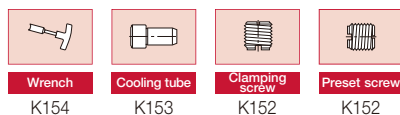

Thermal shrinking holder for carbide and HSS shanks (HSK-A)

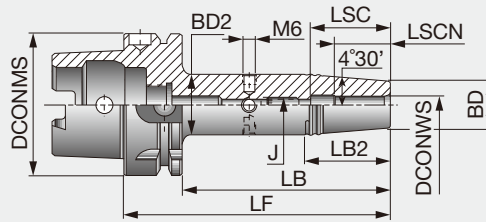

Designation	DCONMS	DCONWS	BD	BD2	LF	LB	LB2	LSCN	LSC	J	Wrench
HSKA63SRKIN6X80	63	6	21	27	80	54	38	25	36	M5	2.5
HSKA63SRKIN6X120	63	6	21	27	120	94	38	25	36	M5	2.5
HSKA63SRKIN6X160	63	6	21	27	160	134	38	25	36	M5	2.5
HSKA63SRKIN8X80	63	8	21	27	80	54	38	25	36	M6	3
HSKA63SRKIN8X120	63	8	21	27	120	94	38	25	36	M6	3
HSKA63SRKIN8X160	63	8	21	27	160	134	38	25	36	M6	3
HSKA63SRKIN10X85	63	10	24	32	85	59	51	31	42	M8	4
HSKA63SRKIN10X120	63	10	24	32	120	94	51	31	42	M8	4
HSKA63SRKIN10X160	63	10	24	32	160	134	51	31	42	M8	4
HSKA63SRKIN12X90	63	12	24	32	90	64	51	36	42	M8	4
HSKA63SRKIN12X120	63	12	24	32	120	94	51	36	47	M10	5
HSKA63SRKIN12X160	63	12	24	32	160	134	51	36	47	M10	5
HSKA63SRKIN14X90	63	14	27	34	90	64	45	36	47	M10	5
HSKA63SRKIN14X120	63	14	27	34	120	94	45	36	47	M10	5
HSKA63SRKIN14X160	63	14	27	34	160	134	45	36	47	M10	5
HSKA63SRKIN16X75	63	16	27	34	75	49	-	39	50	-	-
HSKA63SRKIN16X95	63	16	27	34	95	69	44	39	50	M12	6
HSKA63SRKIN16X120	63	16	27	34	120	94	44	39	50	M12	6
HSKA63SRKIN16X160	63	16	27	34	160	134	44	39	50	M12	6
HSKA63SRKIN18X95	63	18	33	42	95	69	57	39	50	M12	6
HSKA63SRKIN18X120	63	18	33	42	120	94	57	39	50	M12	6
HSKA63SRKIN18X160	63	18	33	42	160	134	57	39	50	M12	6
HSKA63SRKIN20X75	63	20	33	41	75	49	-	41	50	-	-
HSKA63SRKIN20X100	63	20	33	42	100	74	57	41	52	M16	8
HSKA63SRKIN20X120	63	20	33	42	120	94	57	41	52	M16	8
HSKA63SRKIN20X160	63	20	33	42	160	134	57	41	52	M16	8
HSKA63SRKIN25X85	63	25	44	53	85	59	-	47	58	-	-
HSKA63SRKIN25X115	63	25	44	53	115	89	55	47	58	M16	8
HSKA63SRKIN32X85	63	32	44	53	85	59	-	47	58	-	-
HSKA63SRKIN32X120	63	32	44	53	120	94	55	47	58	M16	8
HSKA100SRKIN6X85	100	6	21	27	85	56	38	25	36	M5	2.5
HSKA100SRKIN6X120	100	6	21	27	120	91	38	25	36	M5	2.5
HSKA100SRKIN6X160	100	6	21	27	160	131	38	25	36	M6	3
HSKA100SRKIN8X85	100	8	21	27	85	56	38	25	36	M6	3
HSKA100SRKIN8X120	100	8	21	27	120	91	38	25	36	M6	3
HSKA100SRKIN8X160	100	8	21	27	160	131	38	25	36	M6	3
HSKA100SRKIN10X90	100	10	24	32	90	61	51	31	42	M8	4
HSKA100SRKIN10X120	100	10	24	32	120	91	51	31	42	M8	4
HSKA100SRKIN10X160	100	10	24	32	160	131	51	31	42	M8	4
HSKA100SRKIN12X95	100	12	24	32	95	66	51	36	47	M10	5
HSKA100SRKIN12X120	100	12	24	32	120	91	51	36	47	M10	5
HSKA100SRKIN12X160	100	12	24	32	160	131	51	36	47	M10	5
HSKA100SRKIN14X95	100	14	27	34	95	66	45	36	47	M10	5
HSKA100SRKIN14X120	100	14	27	34	120	91	45	36	47	M10	5
HSKA100SRKIN14X160	100	14	27	34	160	131	45	36	47	M10	5
HSKA100SRKIN16X100	100	16	27	34	100	71	45	39	50	M12	6
HSKA100SRKIN16X120	100	16	27	34	120	91	45	39	50	M12	6
HSKA100SRKIN16X160	100	16	27	34	160	131	45	39	50	M12	6
HSKA100SRKIN18X100	100	18	33	42	100	71	57	39	50	M12	6
HSKA100SRKIN18X160	100	18	33	42	160	131	57	39	50	M12	6
HSKA100SRKIN20X105	100	20	33	42	105	76	57	41	52	M16	8
HSKA100SRKIN20X160	100	20	33	42	160	131	57	41	52	M16	8
HSKA100SRKIN25X115	100	25	44	53	115	86	57	47	58	M16	8
HSKA100SRKIN32X120	100	32	44	53	120	91	57	47	58	M16	8

- When using an HSK type holder with the capability of internal coolant supply, be sure to use a cooling tube (sold separately).
- Please use an induction heating unit for SRKIN holder
- Applicable for 10 MPa coolant

Reference pages



Induction heating unit
K143



Heating unit
K143



Preset screw
K152



Wrench
K154



Cooling tube
K153

HSK FM-SRKIN

Thermal shrinking holder for carbide and HSS shanks (DIN69871)

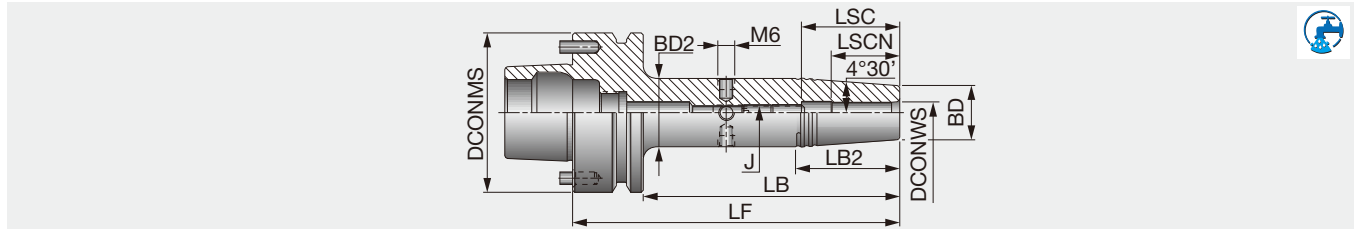

Designation	DCONMS	DCONWS	BD	BD2	LF	LB	LB2	LSCN	LSC	J	Wrench
HSKFM63SRKIN25X115	63	25	44	52.7	115	89	55	47	58	M16	8

- When using an HSK type holder with the capability of internal coolant supply, be sure to use a cooling tube (sold separately)
- Please use an induction heating unit for SRKIN holder
- The driving pins can be removed, turning the toolholder into a standard HSK F63 type.
- Applicable for 10 MPa coolant

HSK E-SRK

Thermal shrinking holder for carbide shank (HSK-E)

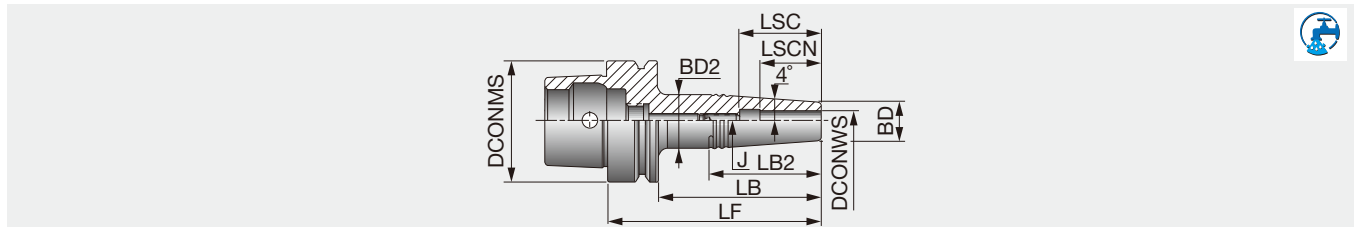

Designation	DCONMS	DCONWS	BD	BD2	LF	LB	LB2	LSCN	LSC	J	Wrench
HSKE32SRK3X45	32	3	10	13	65	45	30	10	16	M4	2
HSKE32SRK4X45	32	4	10	15	65	45	35	12	18	M4	2
HSKE32SRK5X45	32	5	10	15	65	45	35	15	25	M4	2
HSKE32SRK6X45	32	6	11	16	65	45	35	18	28	M4	2
HSKE32SRK10X45	32	10	16	22	65	45	42	30	40	M4	2
HSKE32SRK12X45	32	12	20	25	65	45	35.6	32	40	M4	2
HSKE40SRK3X45	40	3	10	13	65	45	30	10	16	M5	2.5
HSKE40SRK3X80	40	3	10	19	100	80	64	10	16	M5	2.5
HSKE40SRK4X45	40	4	10	15	65	45	35	12	18	M5	2.5
HSKE40SRK4X80	40	4	10	19	100	80	64	12	18	M5	2.5
HSKE40SRK5X45	40	5	10	15	65	45	35	15	25	M4	2
HSKE40SRK5X80	40	5	10	19	100	80	64	15	25	M4	2
HSKE40SRK6X45	40	6	11	16	65	45	35	18	28	M5	2.5
HSKE40SRK6X80	40	6	11	20	100	80	64	18	28	M5	2.5
HSKE40SRK8X45	40	8	14	20	65	45	42	25	35	M5	2.5
HSKE40SRK8X80	40	8	14	23	100	80	64	25	35	M6	3
HSKE40SRK10X45	40	10	16	22	65	45	42	30	40	M5	2.5
HSKE40SRK10X80	40	10	16	24.5	100	80	60	30	40	M8	4
HSKE40SRK12X45	40	12	20	26	65	45	42	32	42	M5	2.5
HSKE40SRK12X80	40	12	20	28	100	80	56	32	42	M10	5
HSKE50SRK3X45 ⁽¹⁾	50	3	10	15	71	45	36	10	16	M5	2.5
HSKE50SRK3X80 ⁽¹⁾	50	3	10	19	106	80	64	10	16	M5	2.5
HSKE50SRK4X45 ⁽¹⁾	50	4	10	15	71	45	36	12	18	M5	2.5
HSKE50SRK4X80 ⁽¹⁾	50	4	10	19	106	80	64	12	18	M5	2.5
HSKE50SRK6X45 ⁽¹⁾	50	6	11	16	71	45	36	18	28	M5	2.5
HSKE50SRK6X80 ⁽¹⁾	50	6	11	20	106	80	64	18	28	M5	2.5
HSKE50SRK8X45 ⁽¹⁾	50	8	14	20	71	45	43	25	35	M6	3
HSKE50SRK8X80 ⁽¹⁾	50	8	14	23	106	80	64	25	35	M6	3
HSKE50SRK10X45 ⁽¹⁾	50	10	16	22	71	45	42	30	37	M6	3
HSKE50SRK10X80 ⁽¹⁾	50	10	16	24.5	106	80	60	30	40	M8	4
HSKE50SRK12X45 ⁽¹⁾	50	12	20	26	71	45	42	32	39	M6	3

(1) Balanced to G2.5 max.n: 35,000 min⁻¹

- When using an HSK type holder with the capability of internal coolant supply, be sure to use a cooling tube (sold separately).
- Applicable for 10 MPa coolant

Reference pages

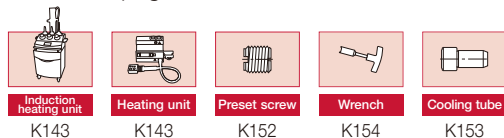

Thermal shrinking holder for carbide shank (HSK-A)

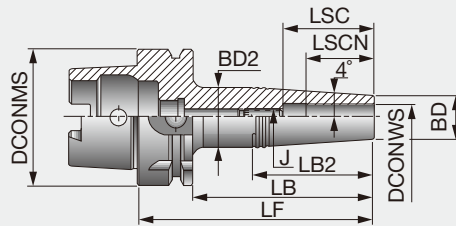

Designation	DCONMS	DCONWS	BD	BD2	LF	LB	LB2	LSCN	LSC	J	Wrench
HSKA63SRK3X50	63	3	10	17	76	50	-	10	16	M6	3
HSKA63SRK3X85	63	3	10	21	111	85	79	10	16	M6	3
HSKA63SRK4X50	63	4	10	17	76	50	-	12	18	M6	3
HSKA63SRK4X85	63	4	10	21	111	85	79	12	18	M6	3
HSKA63SRK5X50	63	5	10	17	76	50	-	15	21	M6	3
HSKA63SRK5X85	63	5	10	21	111	85	79	15	21	M6	3
HSKA63SRK6X50	63	6	11	18	76	50	-	18	24	M8	4
HSKA63SRK6X85	63	6	11	22	111	85	79	18	24	M8	4
HSKA63SRK8X50	63	8	14	20	76	50	43	25	36	M6	3
HSKA63SRK8X85	63	8	14	23	111	85	64	25	36	M6	3
HSKA63SRK10X50	63	10	16	23	76	50	-	30	41	M8	4
HSKA63SRK10X85	63	10	16	26	111	85	72	30	41	M8	4
HSKA63SRK12X50	63	12	20	27	76	50	-	32	43	M8	4
HSKA63SRK12X85	63	12	20	30	111	85	72	32	43	M8	4

- Applicable for 10 MPa coolant
- When using an HSK type holder with the capability of internal coolant supply, be sure to use a cooling tube (sold separately).

HSK E-SEM

Shell mill holder (HSK-E)

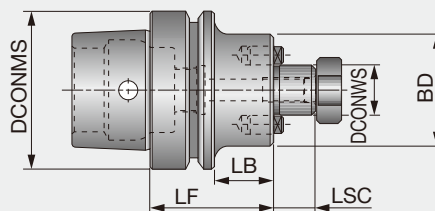

Designation	DCONMS	DCONWS	LSC	BD	LF	LB
HSKE40SEM3/4X2.000	40	19.05	17	45	50.8	30.8
HSKE63SEM1X2.375	63	25.4	17	52.8	60.3	34.3

- Applicable for 7 MPa coolant
- When using an HSK type holder with the capability of internal coolant supply, be sure to use a cooling tube (sold separately).

Option: Wrench for center bolt

Reference pages



Induction heating unit

K143



Heating unit

K143



Preset screw

K152



Clamping screw

K151



Wrench

K153, K154



Cooling tube

K153

HSK A-SEM

Shell mill holder (HSK-A)

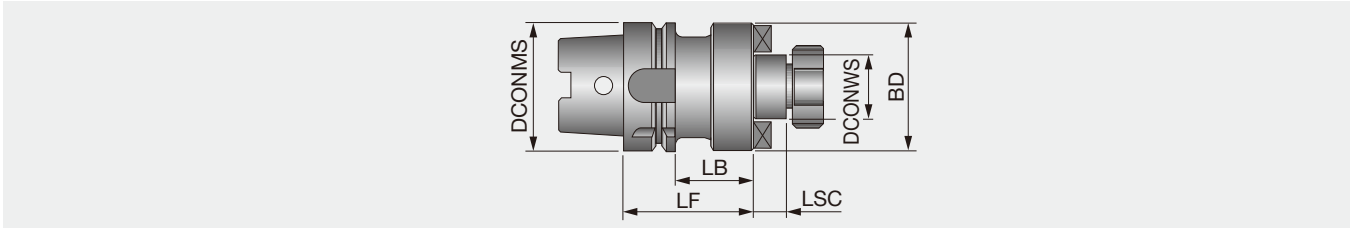

Designation	DCONMS	DCONWS	LB	BD	LF	LSC
HSKA63SEM16X50	63	16	24	38	50	17
HSKA63SEM22X50	63	22	24	47	50	19
HSKA63SEM27X60	63	27	34	58	60	21
HSKA63SEM32X60	63	32	34	66	60	24
HSKA63SEM40X60	63	40	34	82	60	27
HSKA100SEM22X50 ⁽¹⁾	100	22	21	47	50	19
HSKA100SEM27X50 ⁽¹⁾	100	27	21	58	50	21
HSKA100SEM32X50 ⁽¹⁾	100	32	21	66	50	24
HSKA100SEM40X60 ⁽¹⁾	100	40	31	82	60	27
HSKA100SEM50X70 ⁽¹⁾	100	50	41	95	70	30

(1) Balanced to G6.3 max.n: 12,000 min⁻¹

- Applicable for 7 MPa coolant
- When using an HSK type holder with the capability of internal coolant supply, be sure to use a cooling tube (sold separately)

Option: Wrench for lock screw

HSK FM-SEM

Shell mill holder (HSK-FM)

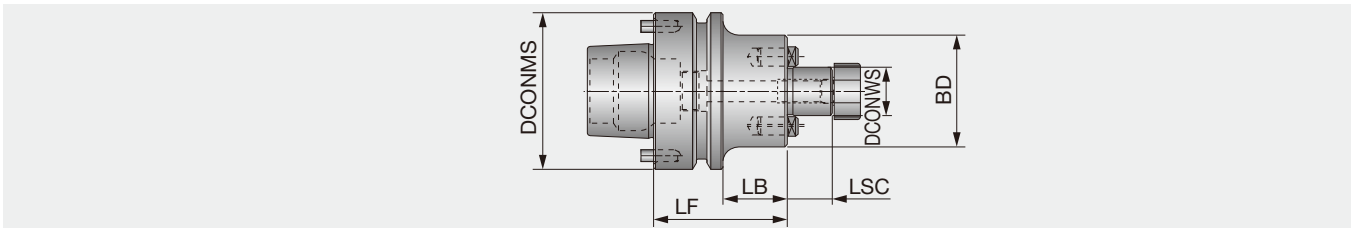

Designation	DCONMS	DCONWS	LSC	BD	LF	LB
HSKFM63SEM22X60	63	22	19	47	60	34
HSKFM63SEM32X60	63	32	24	66	60	34
HSKFM63SEM3/4X3.00	63	19.05	17	45	76.2	50.2
HSKFM63SEM3/4X4.50	63	19.05	17	45	114.3	88.3
HSKFM63SEM1X2.375	63	25.4	17	52.8	60.3	34.3

- Applicable for 7 MPa coolant
- The specification is based on HSK63F type.
- This item improves torque transmission with two drive pins.
- When using an HSK type holder with the capability of internal coolant supply, be sure to use a cooling tube (sold separately).

Option: Wrench for lock screw

Reference pages

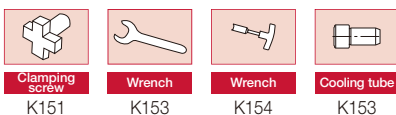

HSK A-FM

Face mill holder (HSK-A)

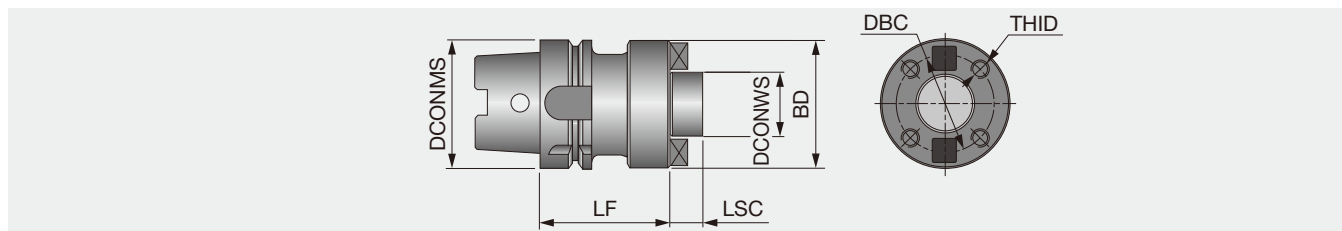

Designation	DCONMS	DCONWS	LSC	BD	LF	DBC	THID
HSKA100FM60X70	100	60	40	128	70	101.6	M16

Option: Wrench for lock screw

HSK A-SEMC

Combination holder for slot mill and shell mill (HSK-A)

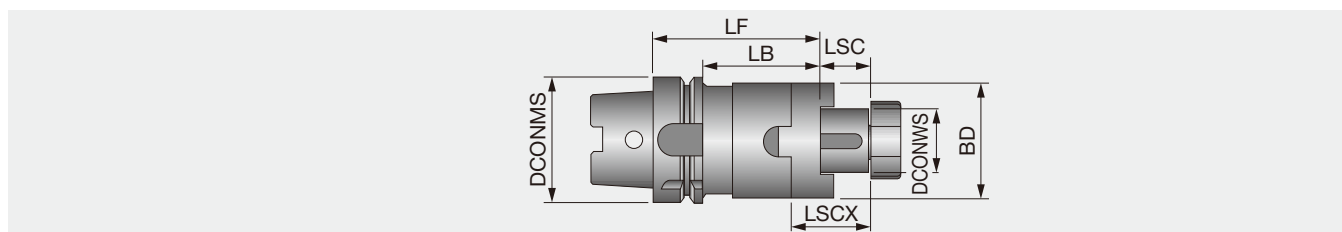

Designation	DCONMS	DCONWS	LSC	BD	LF	LB	LSCX
HSKA63SEMC16X60	63	16	17	32	60	34	21
HSKA63SEMC22X60	63	22	19	40	60	34	31
HSKA63SEMC27X60	63	27	21	48	60	34	33
HSKA63SEMC32X60	63	32	24	58	60	34	38
HSKA63SEMC40X70	63	40	27	70	70	44	41
HSKA100SEMC16X60	100	16	17	32	60	31	27
HSKA100SEMC22X60	100	22	19	40	60	31	31
HSKA100SEMC27X60	100	27	21	48	60	31	33
HSKA100SEMC32X60	100	32	24	58	60	31	38
HSKA100SEMC40X70	100	40	27	70	70	41	41
HSKA100SEMC50X80	100	50	30	90	80	51	46

• Applicable for 7 MPa coolant

Option: Wrench for lock screw

Side lock

Collet chuck

Face mill

Milling chuck

Hydro chuck

Shrinking chuck

Others

Reference pages



Clamping screw
K151



Wrench
K153



Wrench
K154



Cooling tube
K153

HSK A-MT

Morse taper holder (HSK-A)

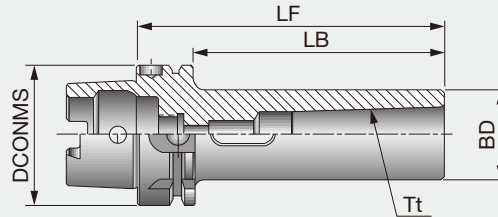

Designation	DCONMS	Tt	LF	BD	LB
HSKA63MT1X110	63	MT1	110	25	84
HSKA63MT2X120	63	MT2	120	32	94
HSKA63MT3X140	63	MT3	140	40	114
HSKA63MT4X160	63	MT4	160	48	134
HSKA100MT1X110	100	MT1	110	25	81
HSKA100MT2X120	100	MT2	120	32	91
HSKA100MT3X150	100	MT3	150	40	121
HSKA100MT4X170	100	MT4	170	48	141
HSKA100MT5X200	100	MT5	200	63	171

ADJ HSK A-ER

ER collet chuck holder with center alignment (HSK-A)

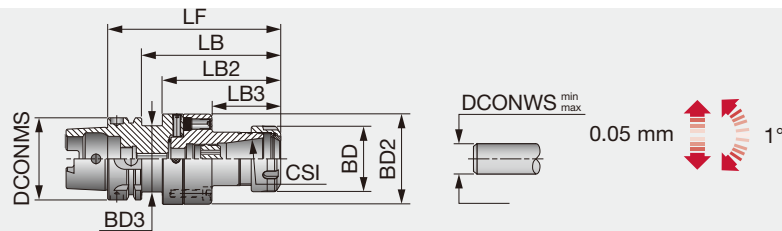

Designation	DCONMS	CSI	Range	LF	LB	LB2	LB3	BD	BD2	BD3
ADJHSKA63D70ER32	63	ER32	2-20	134.5	108.5	92.5	52.5	50	70	46
ADJHSKA100D70ER32	100	ER32	2-20	130	101	-	53	50	70	-

• Applicable for 10 MPa coolant

Option: Wrench for ER collet

TUNGCLICK

HSK A-CLICKIN

Quick change holder (HSK-A)

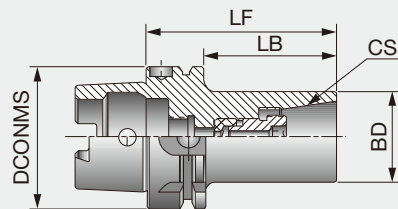

Designation	DCONMS	CSI	BD	LF	LB
HSKA63ER32CLICK-IN	63	32SRF	41	85	59

• Applicable for 10 MPa coolant • Clamping torque: 235 N-m

Reference pages

ER collet	Nut	Preset screw	Wrench	Cooling tube
K124 -	K148	K151	K150, K154	K153

TUNGFIT

HSK A-CF

Quick change holder (HSK-A)

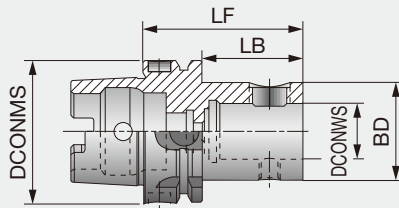

Designation	DCONMS	DCONWS	BD	LF	LB
HSKA63CF4-S	63	25	44.5	70	44
HSKA80CF4-S	80	25	44.5	73	47
HSKA100CF4-S	100	25	44.5	76	47

• Applicable for 7 MPa coolant • Clamping torque: 58.8 N-m

TUNGFLEX

HSK A-ODP

Screw-clamp holder for modular heads (HSK-A)

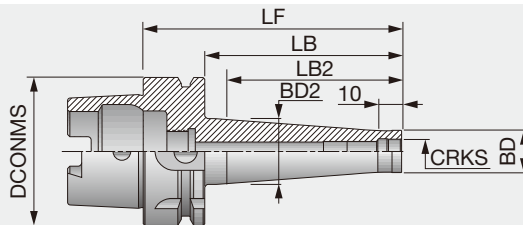

Designation	DCONMS	CRKS	BD	BD2	LF	LB	LB2
HSKA63ODP6X59	63	M6	9.7	10	59	33	25
HSKA63ODP6X109	63	M6	9.8	23	109	83	75
HSKA63ODP8X59	63	M8	13.1	15	59	33	25
HSKA63ODP8X109	63	M8	13.1	23	109	83	75
HSKA63ODP10X59	63	M10	18	20	59	33	25
HSKA63ODP10X109	63	M10	18	28	109	83	75
HSKA63ODP12X59	63	M12	21	24	59	33	25
HSKA63ODP12X109	63	M12	21	31	109	83	75
HSKA63ODP16X59	63	M16	29	34	59	33	25
HSKA63ODP16X109	63	M16	29	34	109	83	75
HSKA100ODP12X87 ⁽¹⁾	100	M12	23	30	87	58	50
HSKA100ODP12X137 ⁽¹⁾	100	M12	23	30	137	108	100
HSKA100ODP12X187 ⁽¹⁾	100	M12	23	40	187	158	150
HSKA100ODP12X237 ⁽¹⁾	100	M12	23	46	237	208	200
HSKA100ODP16X87 ⁽¹⁾	100	M16	29	31.5	87	58	50
HSKA100ODP16X137 ⁽¹⁾	100	M16	29	41.5	137	108	100
HSKA100ODP16X187 ⁽¹⁾	100	M16	29	55	187	158	150
HSKA100ODP16X237 ⁽¹⁾	100	M16	29	55	237	208	200

• Applicable for 10 MPa coolant
(1) Balanced to G6.5 max.n:12,000 min⁻¹

Reference pages



Wrench

K154



Cooling tube

K153

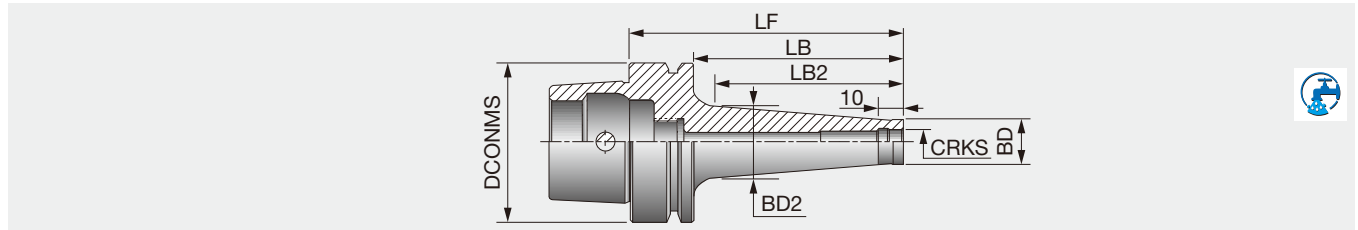

Designation	DCONMS	CRKS	BD	BD2	LF	LB	LB2
HSKE40ODP10X53	40	M10	18	20	53	33	25
HSKE40ODP10X103	40	M10	18	28	103	83	75
HSKE40ODP12X53	40	M12	21	24	53	33	25
HSKE40ODP12X103	40	M12	21	31	103	83	75
HSKE50ODP10X59 ⁽¹⁾	50	M10	18	20	59	33	25
HSKE50ODP10X109 ⁽¹⁾	50	M10	18	28	109	83	75
HSKE50ODP12X59 ⁽¹⁾	50	M12	21	24	59	33	25
HSKE50ODP16X59 ⁽¹⁾	50	M16	29	34	59	33	25
HSKE50ODP16X109 ⁽¹⁾	50	M16	29	34	109	83	75
HSKE63ODP10X59 ⁽²⁾	63	M10	18	20	59	33	25
HSKE63ODP10X109 ⁽²⁾	63	M10	18	28	109	83	75
HSKE63ODP12X59 ⁽²⁾	63	M12	21	24	59	33	25
HSKE63ODP12X109 ⁽²⁾	63	M12	21	31	109	83	75

• Applicable for 10 MPa coolant
 (1) Balanced to G2.5 max.n: 35,000 min⁻¹. (2) Balanced to G2.5 max.n: 30,000 min⁻¹.

HSK Blanks

Blank for holders (HSK)

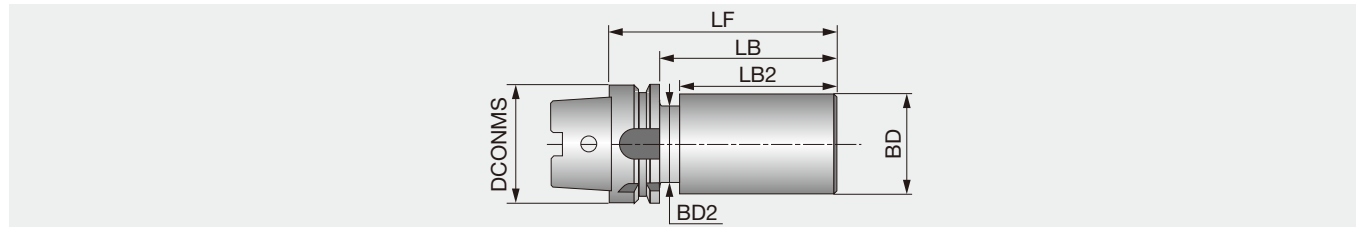

Designation	DCONMS	BD	BD2	LF	LB	LB2
HSKA63B16MN100	63	63	52.8	100	74	55.5
HSKA63B16MN200	63	63	52.8	200	174	155.5
HSKA100B16MN100	100	102	85	100	71	54.8
HSKA100B16MN200	100	102	85	200	171	154.8

• Material: Case hardened alloy steel
 • Shank hardness: 58 HRC minimum
 • Nose hardness: 35-37 HRC

Reference pages

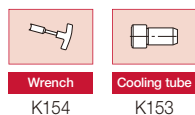

BT-FC-ER

ER collet chuck holders with BT MAS-403 face contact AD tapered shanks

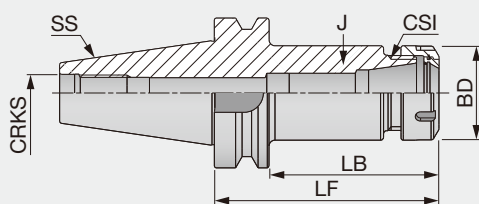

Designation	SS	CSI	BD	LF	LB	J	CRKS
BT30FCER16X70 ⁽¹⁾	30	ER16	28	70	48	M10	M12
BT30FCER16X100 ⁽¹⁾	30	ER16	28	100	79	M10	M12
BT30FCER20X70 ⁽¹⁾	30	ER20	34	70	48	M12	M12
BT30FCER25X60 ⁽¹⁾	30	ER25	42	60	38	M16	M12
BT30FCER32X60 ⁽¹⁾	30	ER32	50	60	38	M18	M12
BT40FCER16X70 ⁽¹⁾	40	ER16	28	70	44	M12	M16
BT40FCER16X100 ⁽¹⁾	40	ER16	28	100	74	M12	M16
BT40FCER32X60 ⁽¹⁾	40	ER32	50	60	34	M22X1.5	M16
BT40FCER32X100 ⁽¹⁾	40	ER32	50	100	74	M22X1.5	M16
BT40FCER40X80 ⁽¹⁾	40	ER40	63	80	54	M28X1.5	M16
BT50FCER16X100 ⁽²⁾	50	ER16	28	100	63.5	M12	M24
BT50FCER16X150 ⁽²⁾	50	ER16	28	150	113.5	M12	M24
BT50FCER32X100 ⁽²⁾	50	ER32	50	100	63.5	M22X1.5	M24
BT50FCER32X150 ⁽²⁾	50	ER32	50	150	113.5	M22X1.5	M24
BT50FCER40X100 ⁽²⁾	50	ER40	63	100	63.5	M28X1.5	M24
BT50FCER40X150 ⁽²⁾	50	ER40	63	150	113.5	M28X1.5	M24

(1) Balanced to G2.5 max.n: 25,000 min⁻¹
 (2) Balanced to G2.5 max.n: 15,000 min⁻¹

Option: Wrench for ER collet

Reference pages



Wrench

K154



Cooling tube

K153

BT-ER collet chuck

ER collet chuck holder (BT)

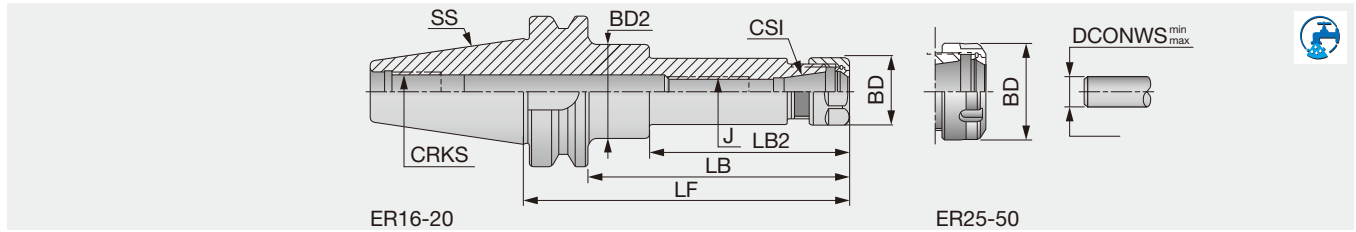

Designation	SS	CSI	Range	LF	LB	LB2	BD	BD2	J	CRKS
BT30ER16X70 ⁽¹⁾	30	ER16	0.5-10	70	48	-	28	-	M10	M12
BT30ER20X70 ⁽¹⁾	30	ER20	1-13	70	48	-	34	-	M12	M12
BT40ER11X100M ⁽²⁾	40	ER11	0.5-7	100	73	-	16	-	M6	M16
BT40ER16X70	40	ER16	0.5-10	70	43	-	28	-	M12	M16
BT40ER16X100	40	ER16	0.5-10	100	73	-	28	-	M12	M16
BT40ER16X150	40	ER16	0.5-10	150	123	86	28	40	M12	M16
BT40ER16X200	40	ER16	0.5-10	200	173	110	28	40	M10	M16
BT40ER20X70	40	ER20	1-13	70	43	-	34	-	M12	M16
BT40ER20X100	40	ER20	1-13	100	73	-	34	-	M12	M16
BT40ER20X120	40	ER20	1-13	120	93	-	34	-	M12	M16
BT40ER20X150	40	ER20	1-13	150	123	-	34	-	M12	M16
BT50ER16X100 ⁽¹⁾	50	ER16	0.5-10	100	62	-	28	-	M12	M24
BT50ER16X125 ⁽¹⁾	50	ER16	0.5-10	125	87	-	28	-	M12	M24
BT50ER16X125B ⁽¹⁾	50	ER16	0.5-10	125	87	-	28	-	M12	M24
BT50ER16X150 ⁽¹⁾	50	ER16	0.5-10	150	112	-	28	-	M12	M24
BT50ER16X200 ⁽¹⁾	50	ER16	0.5-10	200	162	85	28	40	M10	M24
BT50ER20X100 ⁽¹⁾	50	ER20	1-13	100	62	-	34	-	M12	M24
BT50ER20X125 ⁽¹⁾	50	ER20	1-13	125	87	-	34	-	M12	M24
BT50ER20X150 ⁽¹⁾	50	ER20	1-13	150	112	-	34	-	M12	M24
BT50ER20X200 ⁽¹⁾	50	ER20	1-13	200	162	85	34	50	M12	M24
BT30ER25X60 ⁽¹⁾	30	ER25	1-16	60	38	-	42	-	M16	M12
BT30ER32X60 ⁽¹⁾	30	ER32	2-20	60	38	-	50	-	M18x1.5	M12
BT30ER32X75	30	ER32	2-20	75	38	-	50	-	M18x1.5	M12
BT40ER25X60	40	ER25	1-16	60	33	-	42	-	M16	M16
BT40ER25X100	40	ER25	1-16	100	73	-	42	-	M16	M16
BT40ER25X150	40	ER25	1-16	150	123	-	42	-	M16	M16
BT40ER32X60	40	ER32	2-20	60	33	-	50	-	M22X1.5	M16
BT40ER32X100	40	ER32	2-20	100	73	-	50	-	M22X1.5	M16
BT40ER32X120	40	ER32	2-20	120	93	-	50	-	M22X1.5	M16
BT40ER32X150	40	ER32	2-20	150	123	-	50	-	M22X1.5	M16
BT40ER40X80	40	ER40	3-26	80	53	-	63	-	M28X1.5	M16
BT40ER40X80B	40	ER40	3-26	80	53	-	63	-	M28X1.5	M16
BT40ER40X100	40	ER40	3-26	100	73	-	63	-	M28X1.5	M16
BT40ER40X150	40	ER40	3-26	150	123	-	63	-	M28X1.5	M16
BT40ER50X90	40	ER50	10-34	90	63	-	78	-	M28X1.5	M16
BT50ER25X100 ⁽¹⁾	50	ER25	1-16	100	62	-	42	-	M16	M24
BT50ER25X150 ⁽¹⁾	50	ER25	1-16	150	112	-	42	-	M16	M24
BT50ER25X200 ⁽¹⁾	50	ER25	1-16	200	162	87	42	55	M16	M24
BT50ER32X100 ⁽¹⁾	50	ER32	2-20	100	62	-	50	-	M22X1.5	M24
BT50ER32X125 ⁽¹⁾	50	ER32	2-20	125	87	-	34	-	M22X1.5	M24
BT50ER32X150 ⁽¹⁾	50	ER32	2-20	150	112	-	50	-	M22X1.5	M24
BT50ER32X200 ⁽¹⁾	50	ER32	2-20	200	162	88	50	63	M22X1.5	M24
BT50ER32X200B ⁽¹⁾	50	ER32	2-20	200	162	88	50	63	M22X1.5	M24
BT50ER40X100 ⁽¹⁾	50	ER40	3-26	100	62	-	63	-	M28X1.5	M24
BT50ER40X150 ⁽¹⁾	50	ER40	3-26	150	112	-	63	-	M28X1.5	M24
BT50ER40X200 ⁽¹⁾	50	ER40	3-26	200	162	-	63	-	M28X1.5	M24
BT50ER50X100 ⁽¹⁾	50	ER50	10-34	100	62	-	78	-	M36X1.5	M24
BT50ER50X150 ⁽¹⁾	50	ER50	10-34	150	112	-	78	-	M36X1.5	M24

• Add B at the end of the designation for the item with coolant through the flange.
 (1) Balanced to G6.3 max.n.: 12,000 min⁻¹. (2) ER11 MINI collet chuck specification

Option: Wrench for ER collet

Reference pages

ER collet	Nut	Wrench	Preset screw	Pull stud
K124 -	K148, K149	K150	K151	K146

Grade

Insert

Ext. Toolholder

Int. Toolholder

Threading

Grooving

Miniature tool

Milling cutter

Endmill

Drilling tool

Tooling System

User's Guide

Index

TUNGSHORT

BT-ER collet

ER collet chuck holder, short type (BT)

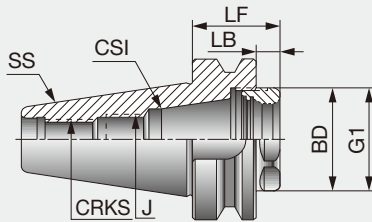

Designation	SS	CSI	Range	LF	LB	BD	J	CRKS	G1
BT30ER20SHORT	30	ER20	1-13	27.2	5.2	25	M12	M12	M25x1.5
BT40ER32SHORT	40	ER32	2-20	36.5	9.5	40	M12	M16	M40x1.5
BT40ER40SHORT	40	ER40	3-26	46.5	9.5	50	M16	M16	M50x1.5
BT50ER32SHORT	50	ER32	2-20	47.5	9.5	40	M22x1.5	M24	M40x1.5
BT50ER32SHORTB	50	ER32	2-20	47.5	9.5	40	M22x1.5	M24	M40x1.5
BT50ER40SHORT	50	ER40	3-26	47.5	9.5	50	M28x1.5	M24	M50x1.5

- Applicable for 10 MPa coolant
- Add B at the end of the designation for the item with coolant through the flange.

Option: Wrench for ER collet

TUNGHYDRO

BT-FC-HYDRO

Hydraulic chuck holders with MAS-BT face contact form AD shanks

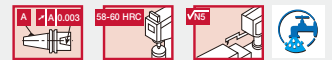
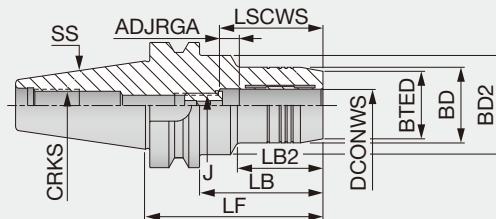

Designation	SS	DCONWS	LF	BTED	BD	BD2	LB	LB2	ADJRGA	LSCWS	J	CRKS
BT30FCHYDRO6X60	30	6	60	23	26	-	38	33	10	37	M5	M12
BT30FCHYDRO8X64	30	8	64	25	28	45	42	29	6	37	M6	M12
BT30FCHYDRO10X64	30	10	64	27	30	-	42	37	10	42	M8x1	M12
BT30FCHYDRO12X72	30	12	72	29	32	-	50	43	10	50	M10x1	M12
BT30FCHYDRO14X70	30	14	70	30	34	-	48	33	10	48	M8x1	M12
BT30FCHYDRO16X90	30	16	90	34	38	-	68	52	10	52	M10x1	M12
BT30FCHYDRO18X90	30	18	90	36	40	-	68	52	10	52	M10x1	M12
BT30FCHYDRO20X90	30	20	90	38	42	42	68	-	10	52	M10x1	M12

Chucking forces will be reduced by 25% if reduction sleeves are used.
Reduction sleeves are available for 12 and 20 mm bore diameters (ordered separately).
Clamping wrench (WRENCHHYDROHEX4) and test bar should be ordered separately.
Balanced to G2.5 max.n: 18,000 min⁻¹
Applicable for 10 MPa coolant.

Option: Wrench

Side lock

Collet chuck

Face mill

Milling chuck

Hydro chuck

Shrinking chuck

Others

Reference pages



ER collet

K124 -



Nut

K149



Wrench

K150



Preset screw

K151



Pull stud

K146

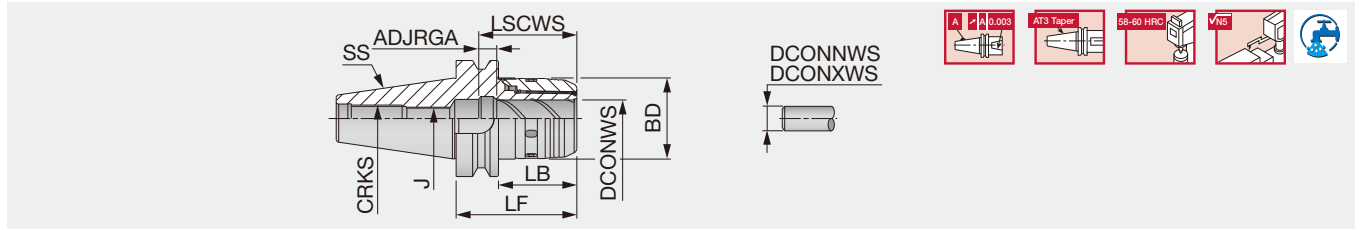

Designation	SS	DCONWS	DCONNWS	DCONXWS	BD	LF	LB	ADJRGA	LSCWS	J	CRKS
BT40FCMAXIN20X85	40	20	6	20	53	85	58	12.8	68.3	M16	M16
BT40FCMAXIN32X108	40	32	6	32	70	108	80.5	13	83	M16	M16
BT50FCMAXIN20X105	50	20	6	20	53	105	67	13.1	68.6	M16	M24
BT50FCMAXIN32X106	50	32	6	32	69.9	106	68	14.3	83.3	M20X2	M24

Applicable for 10 MPa coolant.

Option: Wrench for TungMax collet

BT-TUNGMAX

Power chuck holder (BT)

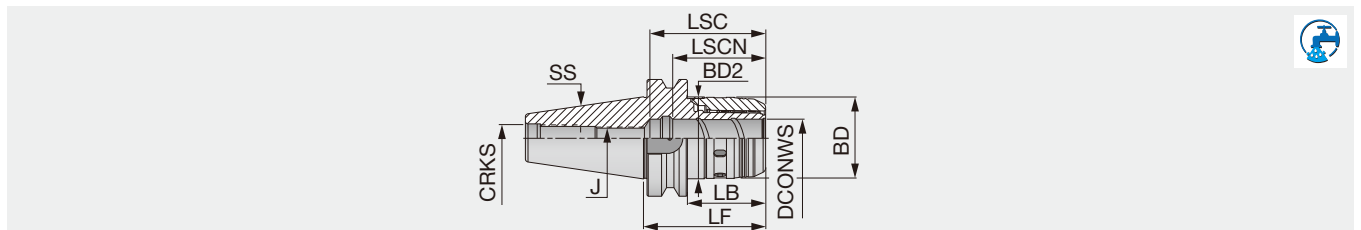

Designation	SS	DCONWS	Range	LF	LB	BD	BD2	LSCN	LSC	J	CRKS
BT40MAXIN20X85	40	20	6-20	85	58	51	53	56	68	M16	M16
BT40MAXIN32X108	40	32	6-32	108	81	69	70	70	83	M16	M16
BT50MAXIN20X105 ⁽¹⁾	50	20	6-20	105	67	51	53	56	69	M16	M24
BT50MAXIN32X106 ⁽¹⁾	50	32	6-32	106	68	69	70	69	83	M20x2	M24
BT50MAXIN32X135 ⁽¹⁾	50	32	6-32	135	97	69	70	69	84	M20x2	M24

- Applicable for 10 MPa coolant
- Add B at the end of the designation for the item with coolant through the flange
- (1) Balanced to G6.3 max.n: 8,000 min⁻¹

Option: Wrench for TungMax collet

Reference pages



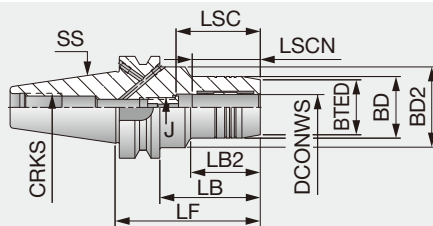

Designation	SS	DCONWS	BTED	BD	BD2	LF	LB	LB2	LSCN	LSC	J	CRKS
BT30HYDRO6X60	30	6	23	26	50	60	38	43	27	37	M5	M12
BT30HYDRO8X64	30	8	25	28	50	64	42	43.5	27	37	M6	M12
BT30HYDRO10X64	30	10	27	30	50	64	42	44	32	42	M8x1	M12
BT30HYDRO12X72	30	12	29	32	50	72	50	44.5	37	47	M10x1	M12
BT30HYDRO14X70	30	14	30	34	50	70	48	47.5	37	47	M10x1	M12
BT30HYDRO16X90	30	16	34	38	50	90	68	47.5	42	52	M12x1	M12
BT30HYDRO18X90	30	18	36	40	50	90	68	47.5	42	52	M12x1	M12
BT30HYDRO20X90	30	20	38	42	50	90	68	47.5	42	52	M12x1	M12
BT40HYDRO6X90	40	6	23	26	50	90	63	43	27	37	M5	M16
BT40HYDRO8X90	40	8	25	28	50	90	63	43.5	27	37	M6	M16
BT40HYDRO10X90	40	10	27	30	50	90	63	44	32	42	M8x1	M16
BT40HYDRO12X90	40	12	29	32	50	90	63	44.5	37	47	M10x1	M16
BT40HYDRO14X90	40	14	30	34	50	90	63	47.5	37	47	M10x1	M16
BT40HYDRO16X90	40	16	34	38	50	90	63	47.5	42	52	M12x1	M16
BT40HYDRO18X90	40	18	36	40	50	90	63	47.5	42	52	M12x1	M16
BT40HYDRO20X90	40	20	38	42	50	90	63	47.5	42	52	M12x1	M16
BT40HYDRO25X90	40	25	46	50	63	90	51	51	48	58	M12x1	M16
BT40HYDRO32X110	40	32	56	60	60	110	81.5	81.5	52	62	M16x1	M16
BT50HYDRO6X110	50	6	23	26	80	110	72	43	27	37	M5	M24
BT50HYDRO8X100	50	8	25	28	80	110	72	43.5	27	37	M6	M24
BT50HYDRO10X110	50	10	27	30	80	110	72	44	32	42	M8x1	M24
BT50HYDRO12X110	50	12	29	32	80	110	72	42	37	47	M10x1	M24
BT50HYDRO14X110	50	14	30	34	80	110	72	42	37	47	M10x1	M24
BT50HYDRO16X110	50	16	34	38	80	110	72	45	42	52	M12x1	M24
BT50HYDRO18X110	50	18	36	40	80	110	72	45	42	52	M12x1	M24
BT50HYDRO20X110	50	20	38	42	80	110	72	47.5	42	52	M12x1	M24
BT50HYDRO25X110	50	25	46	50	80	110	72	47.5	48	58	M12x1	M24
BT50HYDRO32X110	50	32	56	60	80	110	72	47.5	54	64	M12x1	M24

- Applicable for 10 MPa coolant
- Reduction sleeves are available for d = 12, 20, 25, and 32mm.
- Chucking force will reduce when using a reduction sleeve.

Option: Wrench for collet

Reference pages



Straight collet

K134



Pull stud

K146



Wrench

K150

BT-FC-EM

DIN1835 Form B endmill holders with BT MAS-403 face contact AD tapered shanks

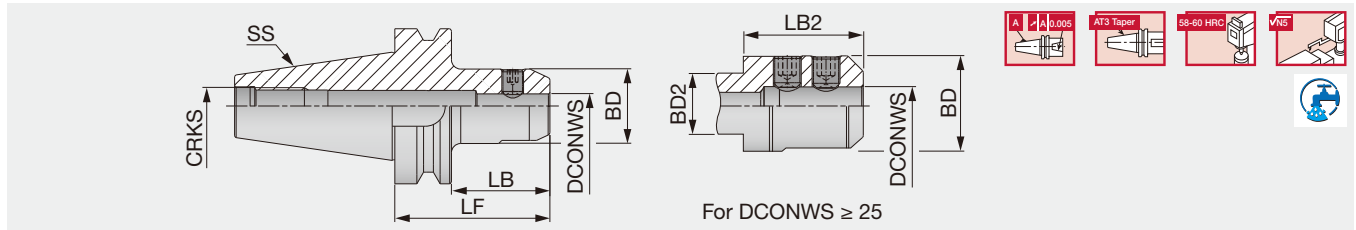

Designation	SS	DCONWS	BD	BD2	LF	LB	LB2	CRKS
BT30FCEM12X60	30	12	42	-	60	38	-	M12
BT30FCEM16X60	30	16	45.9	-	60	38	-	M12
BT30FCEM20X80	30	20	52	44.4	80	58	48	M12
BT40FCEM10X65	40	10	35	-	65	39	-	M16
BT40FCEM12X65	40	12	42	-	65	39	-	M16
BT40FCEM16X65	40	16	48	-	65	39	-	M16
BT40FCEM20X75	40	20	52	-	75	49	-	M16
BT40FCEM25X105	40	25	65	61	105	79	68	M16
BT40FCEM32X110	40	32	71	61	110	83	73	M16
BT50FCEM12X100	50	12	42	-	100	62	-	M24
BT50FCEM16X100	50	16	48	-	100	63.5	-	M24
BT50FCEM20X100	50	20	52	-	100	63.5	-	M24
BT50FCEM25X115	50	25	65	-	115	78.5	-	M24
BT50FCEM32X115	50	32	71	-	115	78.5	-	M24
BT50FCEM40X115	50	40	90	-	115	78.5	-	M24
BT50FCEM50X125	50	50	100	-	125	87	-	M24

Applicable for 10 MPa coolant.

Reference pages

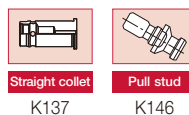

Straight collet

Pull stud

K137

K146



BT-EM

Side lock holder for weldon endmills (BT)

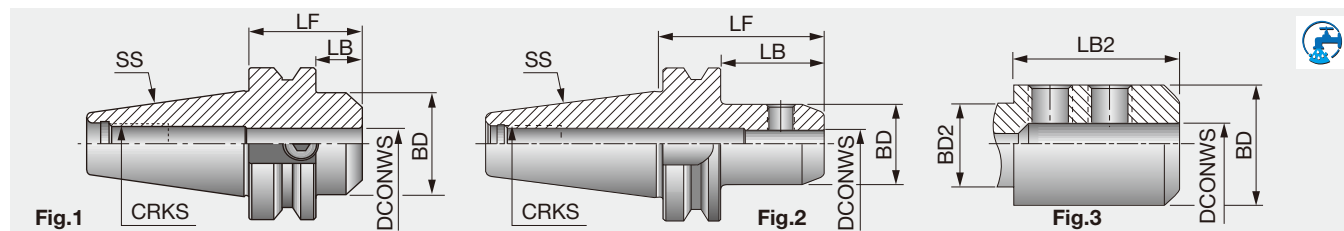

Designation	SS	DCONWS	BD	BD2	LF	LB	LB2	CRKS	Fig.
BT40EM10X45	40	10	35	-	45	18	-	M16	1
BT40EM12X45	40	12	42	-	45	18	-	M16	1
BT40EM14X45	40	14	44	-	45	18	-	M16	1
BT40EM16X45	40	16	48	-	45	18	-	M16	1
BT40EM20X45	40	20	52	-	45	18	-	M16	1
BT40EM25X45	40	25	63	-	45	-	-	M16	1
BT30EM6X50	30	6	25	-	50	28	-	M12	2
BT30EM8X60	30	8	28	-	60	38	-	M12	2
BT30EM10X60	30	10	35	-	60	38	-	M12	2
BT30EM14X50	30	14	44	-	50	38	-	M12	2
BT40EM6X50	40	6	25	-	50	23	-	M16	2
BT40EM6X50B	40	6	25	-	50	23	-	M16	2
BT40EM8X50	40	8	28	-	50	23	-	M16	2
BT40EM10X65	40	10	35	-	65	38	-	M16	2
BT40EM12X65	40	12	42	-	65	38	-	M16	2
BT40EM14X65	40	14	44	-	65	38	-	M16	2
BT40EM16X65	40	16	48	-	65	38	-	M16	2
BT40EM18X65	40	18	50	-	65	38	-	M16	2
BT40EM20X75	40	20	52	-	75	48	-	M16	2
BT40EM20X75B	40	20	52	-	75	48	-	M16	2
BT40EM25X105	40	25	65	61	105	78	68	M16	3
BT40EM32X110	40	32	71	61	110	83	73	M16	3
BT50EM6X70	50	6	25	-	70	32	-	M24	2
BT50EM8X70	50	8	28	-	70	32	-	M24	2
BT50EM10X70	50	10	35	-	70	32	-	M24	2
BT50EM12X100	50	12	42	-	100	62	-	M24	2
BT50EM14X100	50	14	44	-	100	62	-	M24	2
BT50EM16X100	50	16	48	-	100	62	-	M24	2
BT50EM20X100	50	20	52	-	100	62	-	M24	2
BT50EM25X115	50	25	65	-	115	77	-	M24	3
BT50EM32X115	50	32	72	-	115	77	-	M24	3
BT50EM40X115	50	40	90	-	115	77	-	M24	3
BT50EM50X125	50	50	98	-	125	87	-	M24	3

- Applicable for 10 MPa coolant
- Add B at the end of the designation for the item with coolant through the flange.

BT-EM C

Side lock holder for weldon endmills, with coolant nozzle (BT)

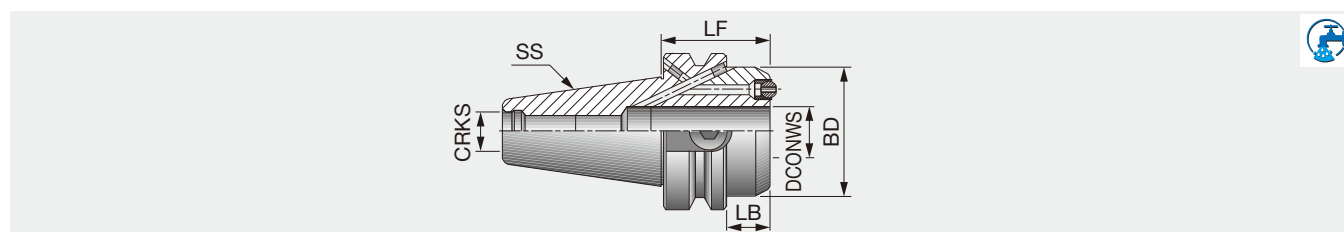

Designation	SS	DCONWS	LF	LB	BD	CRKS
BT40EM12X45C	40	12	45	18	42	M16
BT40EM20X45C	40	20	45	18	52	M16

- Applicable for 10 MPa coolant

Reference pages

Pull stud
K146Clamping screw
K152

BT-EM E

Side lock holder for whistle notch (BT)

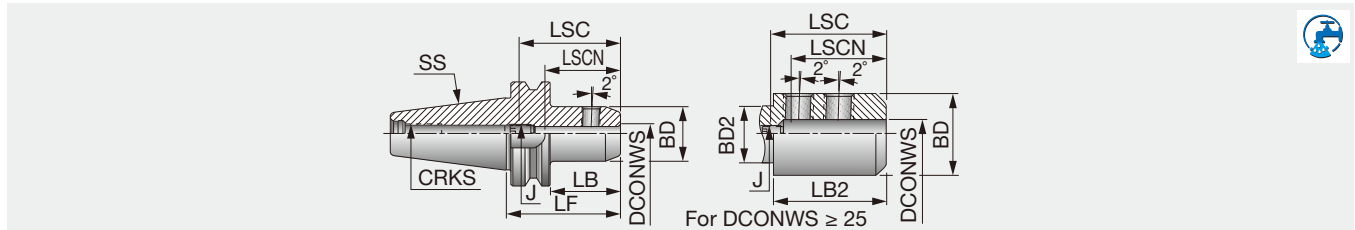

Designation	SS	DCONWS	BD	BD2	LF	LB	LB2	LSCN	LSC	J ⁽¹⁾	CRKS	Wrench
BT40EM8X50E	40	8	28	-	50	23	-	35	45	M6	M16	3
BT40EM8X50EB	40	8	28	-	50	23	-	35	45	M6	M16	3
BT40EM16X65E	40	16	48	-	65	38	-	47	57	M12	M16	6
BT40EM20X75E	40	20	52	-	75	48	-	49	59	M16	M16	8
BT40EM25X105E	40	25	65	61	105	78	68	54	64	M20X1.5	M16	10
BT50EM6X70E	50	6	25	-	70	32	-	35	45	M5	M24	2.5
BT50EM8X70E	50	8	28	-	70	32	-	35	45	M6	M24	3
BT50EM14X100E	50	14	44	-	100	62	-	44	54	M10	M24	5
BT50EM18X100E	50	18	50	-	100	62	-	47	57	M12	M24	6
BT50EM25X115E	50	25	65	-	115	77	-	54	64	M20X1.5	M24	10
BT50EM32X115E	50	32	72	-	115	77	-	58	68	M20X1.5	M24	10
BT50EM40X115E	50	40	90	-	115	77	-	68	78	M20X1.5	M24	10
BT50EM50X125E	50	50	98	-	125	67	-	78	88	M20X1.5	M24	10

- Applicable for 10 MPa coolant
- Add B at the end of the designation for the item with coolant through the flange.
- (1) Preset screw has an internal coolant hole.

TUNGSHRINK

BT-FC-SRK

Thermal shrinking holders with BT MAS-403 face contact AD tapered shanks, for carbide shanks

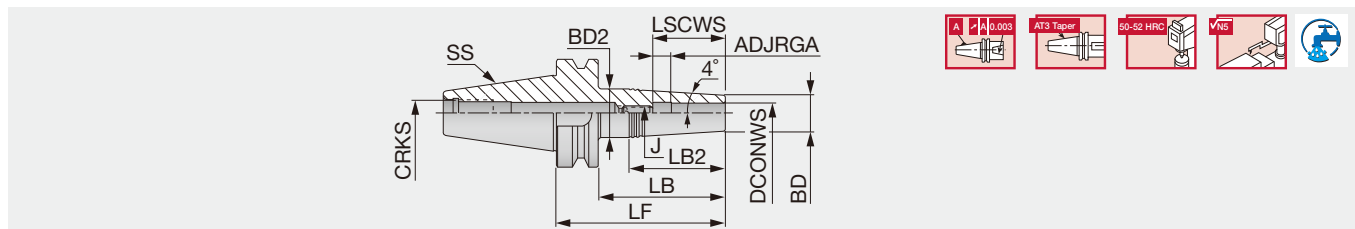

Designation	SS	DCONWS	BD	BD2	LF	LB	LB2	ADJRGA	LSCWS	J	CRKS
BT30FCSRK3X50	30	3	9.93	15	72	50	36.3	0	10	M6	M12
BT30FCSRK4X50	30	4	9.93	15	72	50	36.3	0	12	M6	M12
BT30FCSRK6X50	30	6	10.88	16	72	50	36.6	0	18	M8	M12
BT30FCSRK8X50	30	8	13.95	20	72	50	43.3	0	25	M10	M12
BT30FCSRK12X50	30	12	20.03	26	72	50	42.7	10	42	M10	M12

- Please use an induction heating unit for SRKIN holder.
- Balanced to G2.5 max.n: 25,000 min⁻¹
- Applicable for 10 MPa coolant.

Reference pages

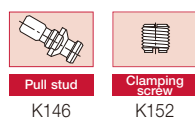

Thermal shrinking holders with BT MAS-403 face contact AD tapered shanks, for carbide, HSS and steel shanks

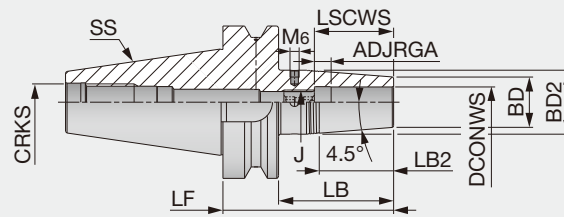

Designation	SS	DCONWS	BD	BD2	LF	LB	LB2	ADJRGA	LSCWS	J	CRKS
BT40FCSRKIN6X90 ⁽¹⁾	40	6	21	27	90	64	38	11	36	M5	M16
BT40FCSRKIN8X90 ⁽¹⁾	40	8	21	27	90	64	38	11	36	M6	M16
BT40FCSRKIN10X90 ⁽¹⁾	40	10	24	32	90	64	50.8	11	42	M8	M16
BT40FCSRKIN12X90 ⁽¹⁾	40	12	24	32	90	64	50.8	11	47	M10	M16
BT40FCSRKIN14X90 ⁽¹⁾	40	14	27	34	90	64	44.5	11	47	M10	M16
BT40FCSRKIN16X90 ⁽¹⁾	40	16	27	34	90	64	44.5	11	50	M12	M16
BT40FCSRKIN18X90 ⁽¹⁾	40	18	33	42	90	64	57.2	11	50	M12	M16
BT40FCSRKIN20X90 ⁽¹⁾	40	20	33	42	90	64	57.2	11	52	M16	M16
BT40FCSRKIN25X110 ⁽¹⁾	40	25	44	53	110	84	57.2	11	58	M16	M16
BT50FCSRKIN6X100 ⁽²⁾	50	6	21	27	100	63.5	38	11	36	M6	M24
BT50FCSRKIN8X100 ⁽²⁾	50	8	21	27	100	63.5	38	11	36	M5	M24
BT50FCSRKIN10X100 ⁽²⁾	50	10	24	32	100	63.5	50.8	11	42	M8	M24
BT50FCSRKIN12X100 ⁽²⁾	50	12	24	32	100	63.5	50.8	11	47	M10	M24
BT50FCSRKIN14X100 ⁽²⁾	50	14	27	34	100	63.5	44.5	11	47	M10	M24
BT50FCSRKIN16X100 ⁽²⁾	50	16	27	34	100	63.5	44.5	11	50	M12	M24
BT50FCSRKIN20X100 ⁽²⁾	50	20	33	42	100	63.5	57.2	11	52	M16	M24
BT50FCSRKIN25X120 ⁽²⁾	50	25	44	53	120	83.5	57.2	11	58	M16	M24
BT50FCSRKIN32X120 ⁽²⁾	50	32	44	53	120	83.5	57.2	11.5	62	M16	M24

Please use an induction heating unit for SRKIN holder.

(1) Balanced to G2.5 max.n: 20,000 min⁻¹

(2) Balanced to G2.5 max.n: 15,000 min⁻¹

Applicable for 10 MPa coolant.

Reference pages



Pull stud

K146



Clamping screw

K152

BT-SRKIN

Thermal shrinking holder for carbide and HSS shanks (BT)

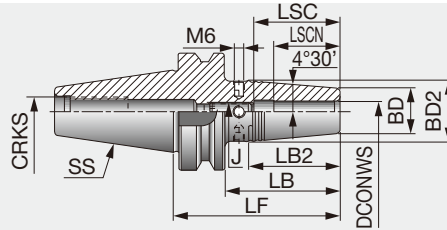

Designation	SS	DCONWS	BD	BD2	LF	LB	LB2	LSCN	LSC	J	CRKS	Wrench
BT40SRKIN6X90	40	6	27	21	90	63	38	25	36	M5	M16	2.5
BT40SRKIN8X90	40	8	27	21	90	63	38	25	36	M6	M16	3
BT40SRKIN10X90	40	10	32	24	90	63	50	31	42	M8	M16	4
BT40SRKIN12X90	40	12	32	24	90	63	50	36	47	M10	M16	5
BT40SRKIN16X90	40	16	34	27	90	63	44	39	50	M12	M16	6
BT40SRKIN18X90	40	18	42	33	90	63	57	39	50	M12	M16	6
BT40SRKIN20X90	40	20	42	33	90	63	57	41	52	M16	M16	8
BT40SRKIN25X110	40	25	53	44	110	83	57	47	58	M16	M16	8
BT50SRKIN6X100 ⁽¹⁾	50	6	26	21	100	62	32	25	36	M5	M24	2.5
BT50SRKIN8X100 ⁽¹⁾	50	8	27	21	100	62	38	25	36	M6	M24	3
BT50SRKIN10X100 ⁽¹⁾	50	10	32	24	100	62	51	31	42	M8	M24	4
BT50SRKIN12X100 ⁽¹⁾	50	12	32	24	100	62	51	36	47	M10	M24	5
BT50SRKIN14X100 ⁽¹⁾	50	14	34	27	100	62	44	36	47	M10	M24	5
BT50SRKIN16X100 ⁽¹⁾	50	16	34	27	100	62	44	39	50	M12	M24	6
BT50SRKIN18X100 ⁽¹⁾	50	18	42	33	100	62	57	39	50	M12	M24	6
BT50SRKIN20X100 ⁽¹⁾	50	20	42	33	100	62	57	41	52	M16	M24	8
BT50SRKIN25X120 ⁽¹⁾	50	25	53	44	120	82	57	47	58	M16	M24	8
BT50SRKIN32X120 ⁽¹⁾	50	32	53	44	120	82	57	47	58	M16	M24	8

- Applicable for 10 MPa coolant
 - Please use an induction heating unit for SRKIN holder.
- (1) Balanced to G2.5 max.n: 20,000 min⁻¹

BT-SRK

Thermal shrinking holder for carbide shank (BT)

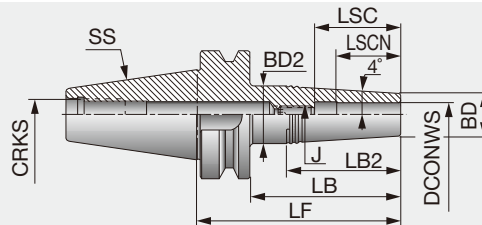

Designation	SS	DCONWS	BD	BD2	LF	LB	LB2	LSCN	LSC	J	CRKS	Wrench
BT40SRK3X50	40	3	10	15	77	50	35.5	10	16	M6	M16	3
BT40SRK3X85	40	3	10	19	112	85	64.1	10	16	M6	M16	3
BT40SRK4X50	40	4	10	15	77	50	35.5	12	18	M6	M16	3
BT40SRK4X85	40	4	10	19	112	85	64.1	12	18	M6	M16	3
BT40SRK5X50	40	5	10	15	77	50	35.5	15	21	M6	M16	3
BT40SRK5X85	40	5	10	19	112	85	64.1	15	21	M6	M16	3
BT40SRK6X50	40	6	11	16	77	50	35.5	18	24	M8	M16	4
BT40SRK6X85	40	6	11	20	112	85	64.1	18	24	M8	M16	4
BT40SRK8X50	40	8	14	20	77	50	42.5	25	31	M10	M16	5
BT40SRK8X85	40	8	14	23	112	85	63.9	25	31	M10	M16	5
BT40SRK10X50	40	10	16	22	77	50	42.4	30	36	M12	M16	6
BT40SRK10X85	40	10	16	25	112	85	60.2	30	36	M12	M16	6
BT40SRK12X50	40	12	20	26	77	50	42.3	32	42	M10	M16	5
BT40SRK12X85	40	12	20	28	112	85	56.6	32	42	M10	M16	5

- Applicable for 10 MPa coolant

Reference pages



Pull stud
K146



Induction heating unit
K143



Heating unit
K143



Preset screw
K152

BT-FC-SEM-C

Shell mill holders with coolant holes and BT MAS-403 face contact AD tapered shanks

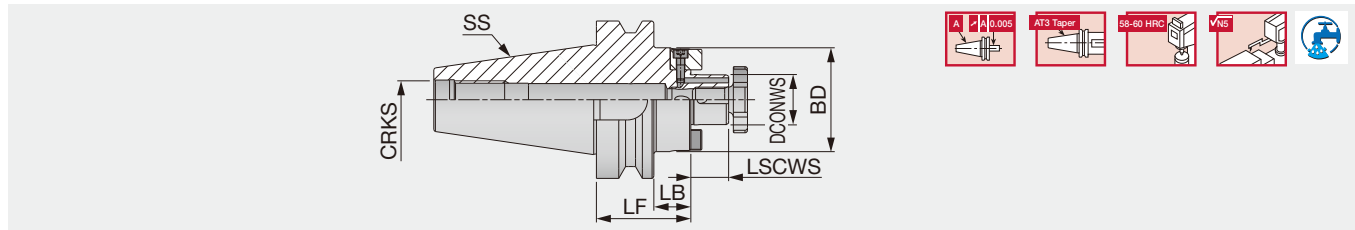

Designation	SS	DCONWS	BD	LF	LB	LSCWS	CRKS
BT30FCSEM16X50C ⁽¹⁾	30	16	38	50	28	17	M12
BT30FCSEM22X50C ⁽¹⁾	30	22	47	50	28	19	M12
BT30FCSEM27X50C ⁽¹⁾	30	27	58	50	28	21	M12
BT40FCSEM16X60C ⁽¹⁾	40	16	38	60	34	17	M16
BT40FCSEM22X60C ⁽¹⁾	40	22	47	60	34	19	M16
BT40FCSEM22X120C ⁽¹⁾	40	22	47	120	94	19	M16
BT40FCSEM27X45C ⁽¹⁾	40	27	58	45	19	21	M16
BT40FCSEM32X60C ⁽¹⁾	40	32	66	60	34	24	M16
BT50FCSEM16X75C ⁽²⁾	50	16	38	75	38.5	17	M24
BT50FCSEM16X120C ⁽²⁾	50	16	38	120	83.5	17	M24
BT50FCSEM22X75C ⁽²⁾	50	22	47	75	38.5	19	M24
BT50FCSEM22X120C ⁽²⁾	50	22	47	120	83.5	19	M24
BT50FCSEM27X60C ⁽²⁾	50	27	58	60	23.5	21	M24
BT50FCSEM27X105C ⁽²⁾	50	27	58	105	68.5	21	M24
BT50FCSEM32X60C ⁽²⁾	50	32	66	60	11.5	24	M24
BT50FCSEM40X60C ⁽²⁾	50	40	82	60	11.5	27	M24

(1) Balanced to G2.5 max.n: 20,000 min⁻¹
 (2) Balanced to G2.5 max.n: 15,000 min⁻¹
 Applicable for 10 MPa coolant.

Option: Wrench for lock screw

BT-FC-FM

Face mill holders with BT MAS-403 face contact A/AD tapered shanks

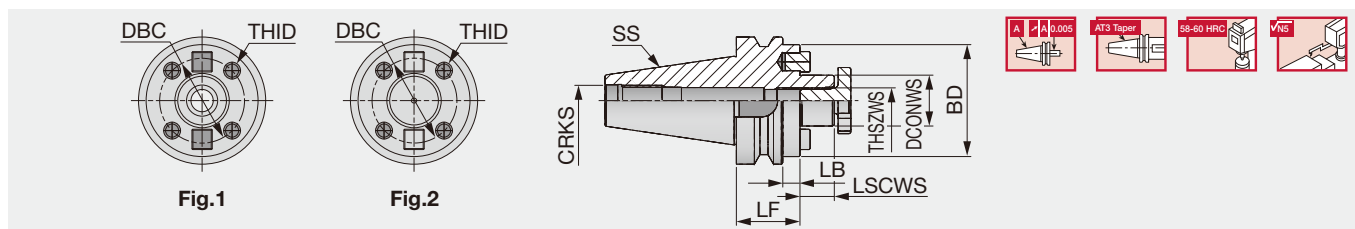

Designation	SS	BD	DCONWS	DBC	LF	LSCWS	LB	CRKS	THSZWS	THID	Fig.
BT40FCFM40 ⁽¹⁾	40	88	40	66.7	60	27	23	M16	M20	M12	1
BT50FCFM40 ⁽¹⁾	50	88	40	66.7	50	27	13.5	M24	M20	M12	1
BT50FCFM60 ⁽²⁾	50	128	60	101.6	88	40	41.5	M24	-	M16	2

(1) Form AD
 (2) Form A

Option: Wrench for lock screw

Reference pages



K146



K151



K153

BT-SEM

Shell mill holder (BT)

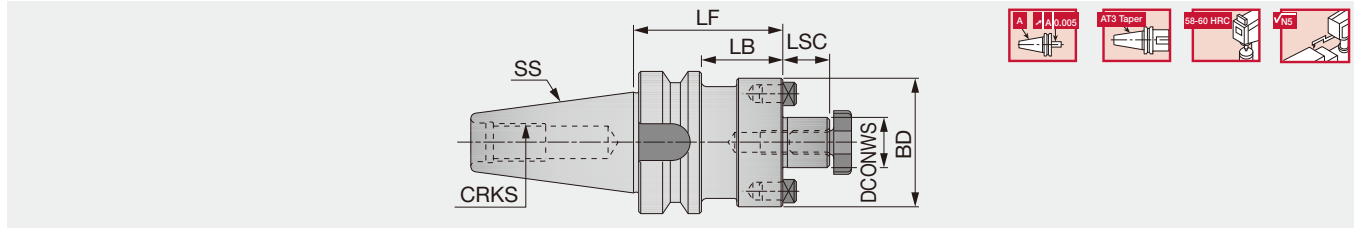

Designation	SS	DCONWS	LSC	BD	LF	LB	CRKS
BT30SEM16X50 ⁽¹⁾	30	16	17	38	50	28	M12
BT30SEM22X50 ⁽¹⁾	30	22	19	47	50	28	M12
BT30SEM27X50 ⁽¹⁾	30	27	21	58	50	18	M12
BT40SEM16X60 ⁽¹⁾	40	16	17	38	60	33	M16
BT40SEM16X120 ⁽¹⁾	40	16	17	38	120	93	M16
BT40SEM22X60 ⁽¹⁾	40	22	19	47	60	33	M16
BT40SEM22X120 ⁽¹⁾	40	22	19	47	120	93	M16
BT40SEM25.4X45V1 ⁽¹⁾	40	25.4	22	50	45	18	M16
BT40SEM27X45 ⁽¹⁾	40	27	21	58	45	18	M16
BT40SEM27X105 ⁽¹⁾	40	27	21	58	105	78	M16
BT40SEM32X60 ⁽¹⁾	40	32	24	65	60	23	M16
BT40SEM32X75 ⁽¹⁾	40	32	24	65	75	36	M16
BT40SEM40X60 ⁽¹⁾	40	40	27	82	60	23	M16
BT40SEM40X75 ⁽¹⁾	40	40	27	82	75	38	M16
BT50SEM16X120 ⁽¹⁾	50	16	17	38	120	82	M24
BT50SEM22X50X220	50	22	19	50	220	182	M24
BT50SEM22X64X320	50	22	19	64	320	282	M24
BT50SEM22X75 ⁽¹⁾	50	22	19	47	75	37	M24
BT50SEM22X120 ⁽¹⁾	50	22	19	47	120	82	M24
BT50SEM27X60 ⁽¹⁾	50	27	21	58	60	22	M24
BT50SEM27X105 ⁽¹⁾	50	27	21	58	105	67	M24
BT50SEM32X48 ⁽¹⁾	50	32	24	66	48	10	M24
BT50SEM32X75 ⁽¹⁾	50	32	24	66	75	37	M24
BT50SEM40X48 ⁽¹⁾	50	40	27	82	48	10	M24
BT50SEM40X75 ⁽¹⁾	50	40	27	82	75	37	M24
BT50SEM50.8X75V1 ⁽¹⁾	50	50.8	36	100	75	37	M24

(1) Can be used for internal coolant supply with the TMBA-**H or CM***H clamping screw.

Option: Wrench for lock screw

Reference pages



BT-SEM-C

Shell mill holder with coolant hole, long type (BT)

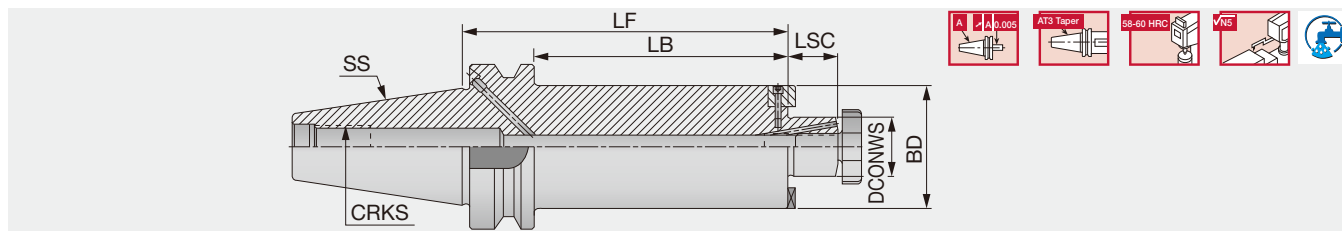

Designation	SS	DCONWS	BD	LF	LB	LSC	CRKS
BT40SEM16X60C	40	16	38	60	33	17	M16
BT40SEM16X100C	40	16	38	100	73	17	M16
BT40SEM22X100C	40	22	47	100	73	19	M16
BT40SEM27X100C	40	27	58	100	73	21	M16
BT40SEM32X60C	40	32	66	60	33	24	M16
BT50SEM16X100C	50	16	38	100	62	17	M24
BT50SEM22X75C	50	22	47	75	37	19	M24
BT50SEM22X48X220C	50	22	48	220	182	19	M24
BT50SEM22X61X320C	50	22	61	320	282	19	M24
BT50SEM25.4X60C	50	25.4	50.4	60	22	22	M24
BT50SEM27X100C	50	27	58	100	62	21	M24
BT50SEM27X61X320C	50	27	61	320	282	21	M24
BT50SEM32X75C	50	32	66	75	37	24	M24
BT50SEM32X100C	50	32	66	100	62	24	M24
BT50SEM32X78X390C	50	32	78	390	352	24	M24

- Applicable for 10 MPa coolant
- When being used as a flange-through type, the plug screw must be removed from the flange with a 2-mm hex key.

Option: Wrench for lock screw

BT-FM

Face mill holder (BT)

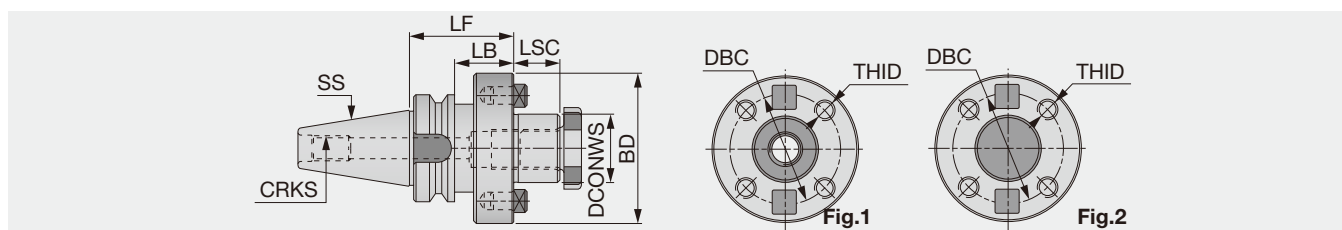

Designation	SS	DCONWS	LSC	LF	LB	BD	DBC	THID	CRKS	Fig.
BT40FM40x60	40	40	27	60	22	88	66.7	M12	M16	1
BT50FM40x50	50	40	27	50	12	88	66.7	M12	M24	1
BT50FM60x88	50	60	38	88	40	128	101.6	M16	M24	2

Option: Wrench for lock screw

Reference pages



K146



K151



K153

BT50-FM

Shell mill holder, long type (BT)

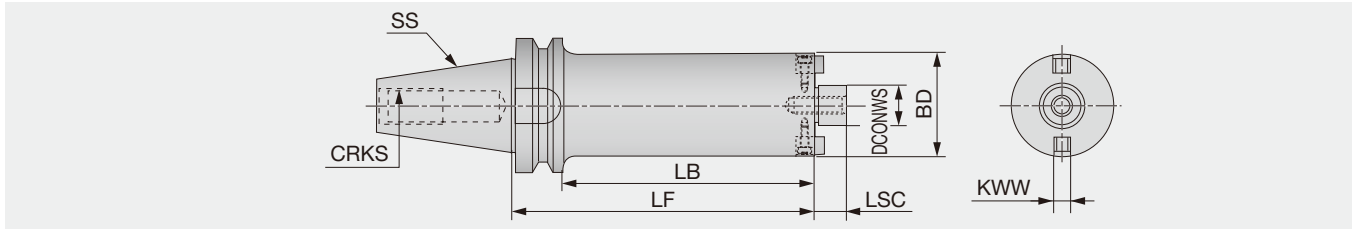

Designation	SS	DCONWS	BD	LSC	LF	LB	CRKS	KWW	WT(kg)
BT50-FMC22-138-47	50	22	47	18	138	100	M24	10	5.2
BT50-FMC22-188-47	50	22	47	18	188	150	M24	10	5.9
BT50-FMC22-243-47	50	22	47	18	243	205	M24	10	6.5
BT50-FMC22-293-47	50	22	47	18	293	255	M24	10	7.2
BT50-FMC22-178-59	50	22	59	18	178	140	M24	10	6.8
BT50-FMC22-238-59	50	22	59	18	238	200	M24	10	8
BT50-FMC22-308-59	50	22	59	18	308	270	M24	10	9.5
BT50-FMC22-373-59	50	22	59	18	373	335	M24	10	10.9
BT50-FMA31.75-215-76	50	31.75	76	30	215	177	M24	12.7	10
BT50-FMA31.75-295-76	50	31.75	76	30	295	257	M24	12.7	12.9
BT50-FMA31.75-375-76	50	31.75	76	30	375	337	M24	12.7	15.8
BT50-FMA31.75-275-96	50	31.75	96	30	275	237	M24	12.7	16.8
BT50-FMA31.75-375-96	50	31.75	96	30	375	337	M24	12.7	23

Option: Wrench for collet

Reference pages



Pull stud
K146

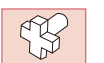

Clamping screw
K151



Wrench
K153

BT-SEMC

Combination holder for slot mill and shell mill (BT)

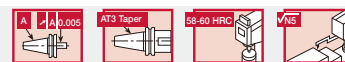
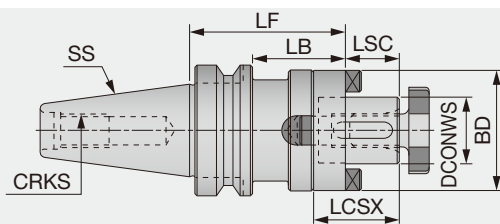

Designation	SS	DCONWS	LSC	BD	LF	LB	LCSX	CRKS
BT40SEMC16X50	40	16	17	32	50	23	27	M16
BT40SEMC16X100	40	16	17	32	100	73	27	M16
BT40SEMC22X53	40	22	19	40	53	26	31	M16
BT40SEMC22X100	40	22	19	40	100	73	31	M16
BT40SEMC27X55	40	27	21	48	55	28	33	M16
BT40SEMC27X100	40	27	21	48	100	73	33	M16
BT40SEMC32X60	40	32	24	58	60	33	38	M16
BT40SEMC32X100	40	32	24	58	100	73	38	M16
BT40SEMC40X80	40	40	27	70	80	53	41	M16
BT50SEMC16X100	50	16	17	32	100	62	27	M24
BT50SEMC16X150	50	16	17	32	150	112	27	M24
BT50SEMC22X68	50	22	19	40	68	30	31	M24
BT50SEMC22X100	50	22	19	40	100	62	31	M24
BT50SEMC22X150	50	22	19	40	150	112	31	M24
BT50SEMC27X78	50	27	21	48	78	40	33	M24
BT50SEMC27X100	50	27	21	48	100	62	33	M24
BT50SEMC27X150	50	27	21	48	150	112	33	M24
BT50SEMC32X78	50	32	24	58	78	40	38	M24
BT50SEMC32X100	50	32	24	58	100	62	38	M24
BT50SEMC32X150	50	32	24	58	150	112	38	M24
BT50SEMC40X78	50	40	27	70	78	40	41	M24
BT50SEMC40X100	50	40	27	70	100	62	41	M24
BT50SEMC40X150	50	40	27	70	150	112	41	M24
BT50SEMC50X79	50	50	30	90	79	41	46	M24
BT50SEMC50X150	50	50	30	90	150	112	46	M24

Option: Wrench for lock screw

Reference pages



Pull stud
K146



Clamping screw
K151



Wrench
K153

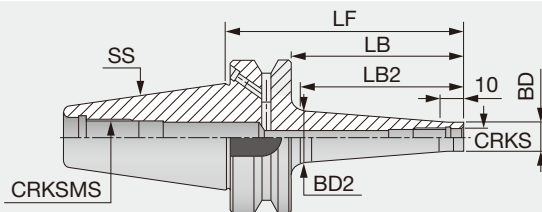

Designation	SS	CRKS	BD	BD2	LF	LB	LB2	CRKSMS
BT40ODP6X66	40	M6	9.8	13	66	39	30	M16
BT40ODP6X106	40	M6	9.8	23	106	79	70	M16
BT40ODP8X66	40	M8	13	15	66	39	30	M16
BT40ODP8X106	40	M8	13	23	106	79	70	M16
BT40ODP10X66	40	M10	18	20	66	39	30	M16
BT40ODP10X106	40	M10	18	28	106	79	70	M16
BT40ODP12X66	40	M12	21	24	66	39	30	M16
BT40ODP12X106	40	M12	21	31	106	79	70	M16
BT40ODP16X66	40	M16	29	28.6	66	39	-	M16
BT40ODP16X106	40	M16	29	34	106	79	70	M16
BT50ODP12X94	50	M12	23	30	94	56	50	M24
BT50ODP12X144 ⁽¹⁾	50	M12	23	40	144	106	100	M24
BT50ODP12X194 ⁽¹⁾	50	M12	23	40	194	156	150	M24
BT50ODP16X94 ⁽¹⁾	50	M16	29	34	94	56	50	M24
BT50ODP16X144 ⁽¹⁾	50	M16	29	40	144	106	100	M24
BT50ODP16X194 ⁽¹⁾	50	M16	29	55	194	156	150	M24
BT50ODP16X244 ⁽¹⁾	50	M16	29	60	244	206	200	M24

• Applicable for 10 MPa coolant
 (1) Balanced to G6.3 max.n: 12,000 min⁻¹

Reference pages



Pull stud

K146

Grade

Insert

Ext. Toolholder

Int. Toolholder

Threading

Grooving

Miniature tool

Milling cutter

Endmill

Drilling tool

Tooling System

User's Guide

Index



BT-DC

Drill chuck holder (DIN238)

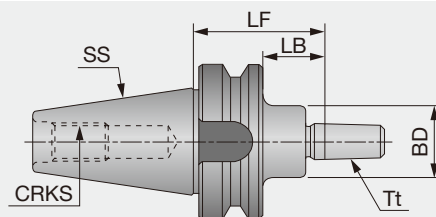

Designation	SS	Tt	LF	BD	LB	CRKS
BT30DCB12X30	30	B12	30	-	8	M12
BT40DCB12X45	40	B12	45	24	18	M16
BT40DCB12X90	40	B12	90	24	63	M16
BT40DCB16X45	40	B16	45	30	18	M16
BT40DCB16X90	40	B16	90	30	63	M16
BT40DCB18X90	40	B18	90	30	63	M16
BT50DCB12X45	50	B12	45	-	6.7	M24
BT50DCB16X45	50	B16	45	-	7	M24
BT50DCB16X105	50	B16	105	50	67	M24
BT50DCB18X45	50	B18	45	-	7	M24
BT50DCB18X105	50	B18	105	30	67	M24

DIN
69871**BT-AD**

Conversion adapter (BT)

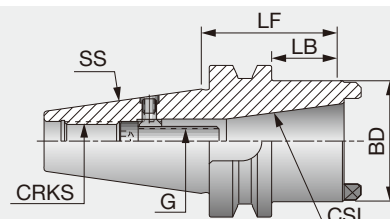

Designation	SS	CSI	LF	BD	LB	G	CRKS
BT50ADBT/SK40	50	DIN69871/A, BT MAS - 403	75	37	66	M16	M24
BT50AD40	50	DIN2080	70	32	63	M16	M24

Side
lockCollet
chuckFace
millMilling
chuckHydro
chuckShrinking
chuck

Others

Reference pages



Pull stud

K146

BT-MT

Morse taper holder (BT)

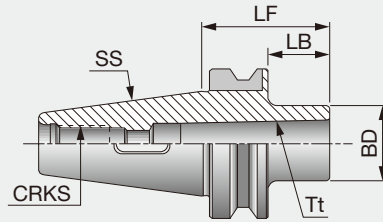

Designation	SS	Tt	LF	LB	BD	CRKS
BT30MT1X45	30	MT1	45	23	25	M12
BT30MT2X60	30	MT2	60	38	32	M12
BT40MT1X45	40	MT1	45	18	25	M16
BT40MT1X120	40	MT1	120	93	25	M16
BT40MT2X60	40	MT2	60	33	32	M16
BT40MT2X120	40	MT2	120	93	32	M16
BT40MT3X75	40	MT3	75	48	40	M16
BT40MT3X139	40	MT3	139	112	40	M16
BT40MT4X95	40	MT4	95	68	50	M16
BT50MT1X45	50	MT1	45	7	25	M24
BT50MT1X120	50	MT1	120	82	25	M24
BT50MT1X180	50	MT1	180	142	25	M24
BT50MT2X45	50	MT2	45	7	32	M24
BT50MT2X135	50	MT2	135	97	32	M24
BT50MT2X180	50	MT2	180	142	32	M24
BT50MT3X45	50	MT3	45	7	40	M24
BT50MT3X150	50	MT3	150	112	40	M24
BT50MT3X180	50	MT3	180	142	40	M24
BT50MT4X75	50	MT4	75	37	50	M24
BT50MT4X180	50	MT4	180	142	50	M24
BT50MT5X105	50	MT5	105	67	70	M24

BT-MT DRW

Morse taper holder with draw bar (BT)

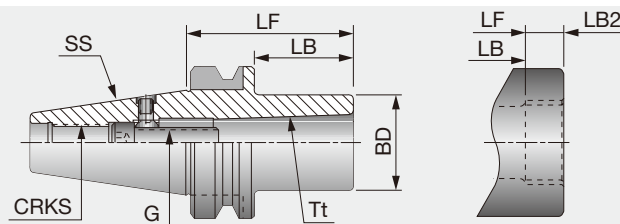

Designation	SS	Tt	LF	LB	LB2	BD	G	CRKS
BT40MT1DRW	40	MT1	50	23	-	25	M6	M16
BT40MT2DRW	40	MT2	50	23	-	32	M10	M16
BT40MT3DRW	40	MT3	70	43	-	40	M12	M16
BT40MT4DRW ⁽¹⁾	40	MT4	95	68	15	63	M16	M16
BT50MT1DRW	50	MT1	45	7	-	25	M6	M24
BT50MT2DRW	50	MT2	60	22	-	32	M10	M24
BT50MT3DRW	50	MT3	65	27	-	40	M12	M24
BT50MT4DRW ⁽¹⁾	50	MT4	70	32	15	63	M16	M24
BT50MT5DRW ⁽¹⁾	50	MT5	100	62	18	78	M20	M24

(1) DIN2201

Reference pages



Pull stud

K146

TUNGFINE**ADJ BT-ER**

ER collet chuck holder with center alignment (BT)

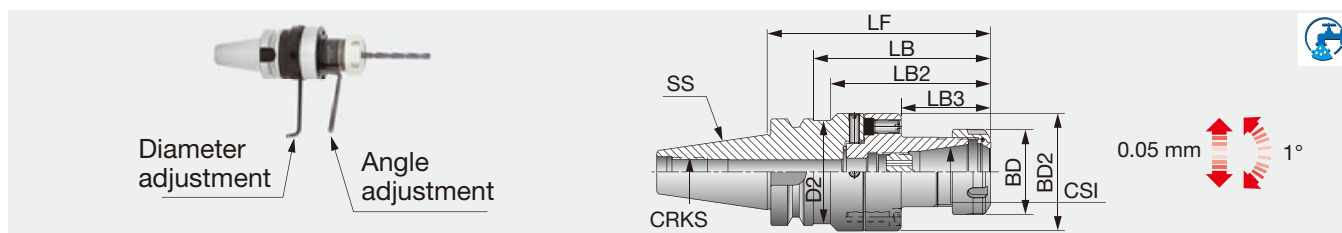

Designation	SS	CSI	Range	LF	LB	LB2	LB3	BD	BD2	BD3	CRKS
ADJBT40D70ER32	40	ER32	2-20	129.5	52.5	102.5	92	50	70	62.5	M16
ADJBT50D70ER32	50	ER32	2-20	144.5	52.5	106.5	-	50	70	-	M24

- Applicable for 10 MPa coolant

Option: Wrench for ER collet

DIN
69871

HSK

BT
MASDIN
2080

Others

Side
lockCollet
chuckFace
millMilling
chuckHydro
chuckShrinking
chuck

Others

Reference pages



ER collet

K124 -



Nut

K149



Wrench

K150



Preset screw

K151



Pull stud

K146

Tapping holder (BT)

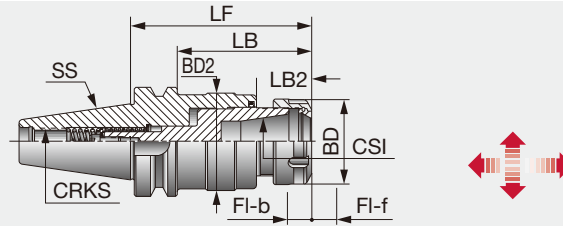

Designation	SS	CSI	Tap min	Tap max	Range	LF	LB	LB2	BD	BD2	FI-f	FI-b	CRKS
GTIBT40ER16	40	ER16	M3	M10	0.5-10	84.2	52.7	24.6	28	29.5	8	3	M16
GTIBT40ER32	40	ER32	M6	M20	2-20	106.8	79.8	33	50	56.5	9	4	M16
GTIBT40ER40	40	ER40	M6	M28	3-26	124.8	97.8	51	63	56.5	9	4	M16
GTIBT50ER16	50	ER16	M3	M10	0.5-10	106.8	68.8	24.6	28	29.5	8	3	M24
GTIBT50ER32	50	ER32	M6	M20	2-20	115.2	77.2	33	50	56.5	9	4	M24
GTIBT50ER40	50	ER40	M6	M28	3-26	133.2	95.2	51	63	56.5	9	4	M24

Option: Wrench for ER collet

TUNG^{FIT}

BT-CF

Quick change holder (BT)

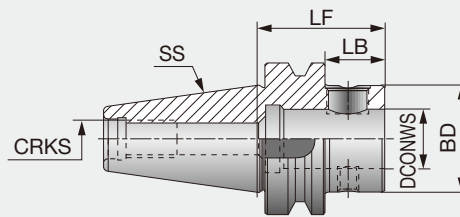

Designation	SS	LF	LB	BD	DCONWS	CRKS
BT40CF4-L	40	110	83	44.5	25	M16
BT40CF4-S	40	52	25	44.5	25	M16
BT50CF4-L	50	115	77	44.5	25	M24
BT50CF4-S	50	63	25	44.5	25	M24

- Applicable for 10 MPa coolant
- Clamping torque: 58.8 N·m

TUNG^{CLICK}

BT-CLICKIN

Quick change holder (BT)

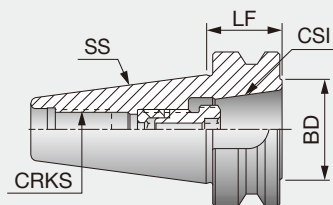

Designation	SS	CSI	BD	LF	CRKS
BT40ER32CLICK-IN	40	32SRF	41	28	M16
BT50ER32CLICK-IN	50	32SRF	41	39	M24

- Applicable for 10 MPa coolant
- Recommend clamping torque: 2.3 N·m

Reference pages

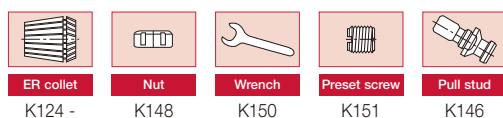

DIN2080-ER

ER collet chuck holder (DIN2080)

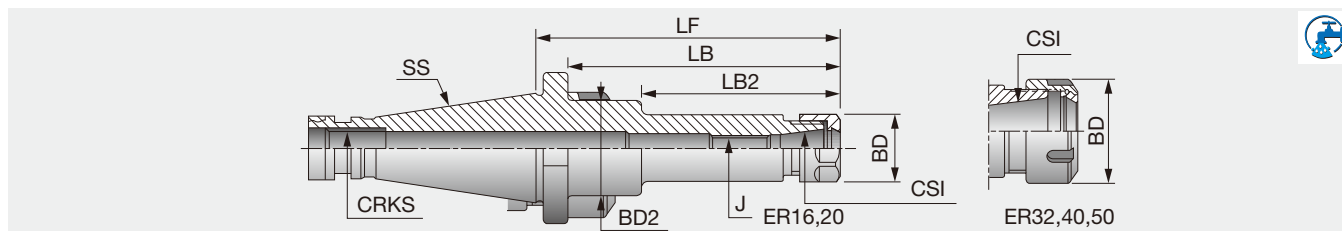

Designation	SS	CSI	Range	LF	LB	LB2	BD	BD2	J	CRKS
DIN208030ER16X75	30	ER16	0.5-10	75	65.4	-	28	-	M10	M12
DIN208030ER32X55	30	ER32	2-20	55	45.4	-	50	-	M18X1.5	M12
DIN208030ER40X83	30	ER40	3-26	83	69.4	-	63	-	M22X1.5	M12
DIN208040ER16X63	40	ER16	0.5-10	63	51.4	-	28	-	M12	M16
DIN208040ER16X100	40	ER16	0.5-10	100	88.4	-	28	-	M12	M16
DIN208040ER25X50	40	ER25	1-16	50	38.4	-	42	-	M16X1.5	M16
DIN208040ER32X50	40	ER32	2-20	50	38.4	-	50	-	M22X1.5	M16
DIN208040ER40X55	40	ER40	3-26	55	43.4	-	63	-	M22X1.5	M16
DIN208040ER20X63	40	ER20	1-13	63	51.4	-	34	-	M12	M16
DIN208040ER20X100	40	ER20	1-13	100	88.4	-	34	-	M12	M16
DIN208050ER20X100	50	ER20	1-13	100	84.8	-	34	-	M16	M24
DIN208050ER20X160	50	ER20	1-13	160	144.8	-	34	-	M12	M24
DIN208050ER40X58	50	ER40	3-26	58	42.8	-	63	-	M28X1.5	M24
DIN208050ER50X63	50	ER50	10-34	63	47.8	-	78	-	M36X1.5	M24

• Applicable for 10 MPa coolant

Option: Wrench for ER collet

DIN
69871

HSK

DIN2080-EM

Side lock holder for weldon endmills (DIN2080)

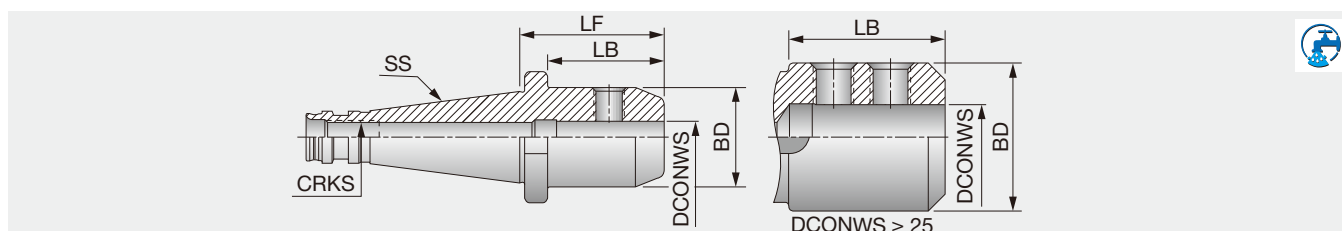

Designation	SS	DCONWS	BD	LF	LB	CRKS
DIN208030EM6X40	30	6	25	40	30.4	M12
DIN208030EM8X40	30	8	28	40	30.4	M12
DIN208030EM10X40	30	10	35	40	30.4	M12
DIN208030EM20X63	30	20	52	63	53.4	M12
DIN208040EM8X50	40	8	28	50	38.4	M16
DIN208040EM10X50	40	10	35	50	38.4	M16
DIN208040EM12X50	40	12	42	50	38.4	M16
DIN208040EM16X63	40	16	48	63	51.4	M16
DIN208040EM20X63	40	20	52	63	51.4	M16
DIN208040EM25X80	40	25	65	80	68.4	M16
DIN208040EM32X80	40	32	71	80	68.4	M16
DIN208050EM8X63	50	8	28	63	47.8	M24
DIN208050EM10X63	50	10	35	63	47.8	M24
DIN208050EM12X63	50	12	42	63	47.8	M24
DIN208050EM16X63	50	16	48	63	47.8	M24
DIN208050EM20X63	50	20	52	63	47.8	M24
DIN208050EM25X80	50	25	65	80	64.8	M24
DIN208050EM32X80	50	32	72	80	64.8	M24
DIN208050EM40X90	50	40	90	90	74.8	M24
DIN208050EM50X100	50	50	100	100	84.8	M24

• Applicable for 10 MPa coolant

Side
lock

Collet
chuck

Face
mill

Milling
chuck

Hydro
chuck

Shrinking
chuck

Others

Reference pages



ER collet

K124 -



Nut

K148



Wrench

K150



Preset screw

K151, K152



Pull stud

K146, K148

DIN2080-SEM

Shell mill holder (DIN2080)

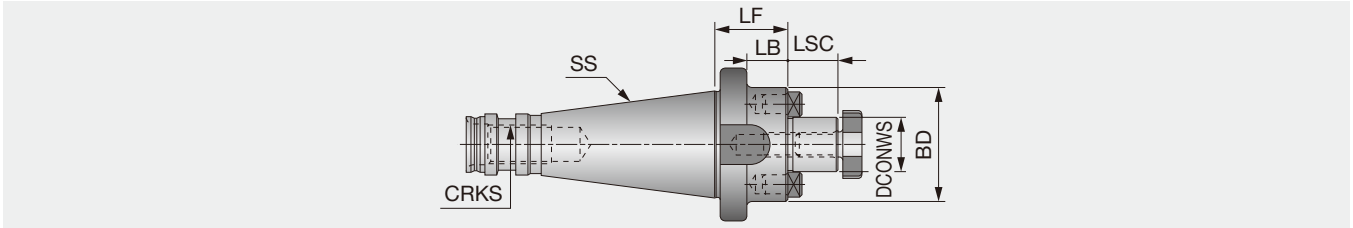

Designation	SS	DCONWS	LSC	BD	LF	LB	CRKS
DIN208030SEM16X28	30	16	17	38	28	18.4	M12
DIN208030SEM22X28	30	22	19	47	28	18.4	M12
DIN208030SEM27X32	30	27	21	58	32	22.4	M12
DIN208040SEM16X28	40	16	17	38	28	16.4	M16
DIN208040SEM22X27	40	22	19	47	27	15.4	M16
DIN208040SEM27X26	40	27	21	58	26	14.4	M16
DIN208040SEM32X23	40	32	24	66	23	11.4	M16
DIN208040SEM40X34	40	40	27	82	34	22.4	M16
DIN208050SEM16X38	50	16	17	38	38	22.8	M24
DIN208050SEM22X38	50	22	19	47	38	22.8	M24
DIN208050SEM27X38	50	27	21	58	38	22.8	M24
DIN208050SEM32X36	50	32	24	66	36	20.8	M24
DIN208050SEM40X40	50	40	27	82	40	24.8	M24

Option: Wrench for lock screw

DIN2080-FM

Face mill holder (DIN2080)

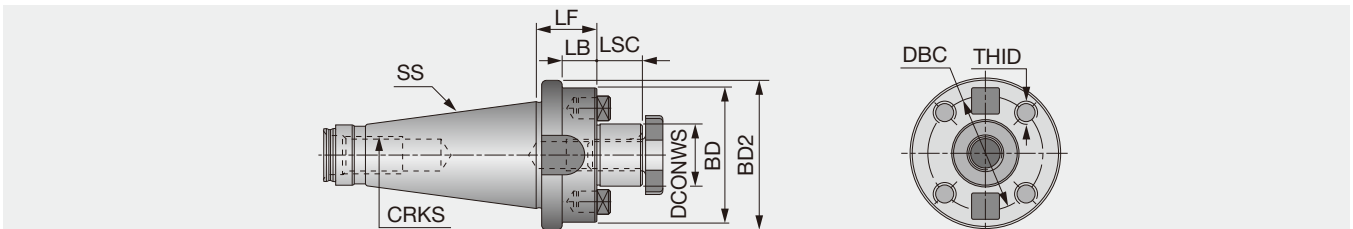

Designation	SS	DCONWS	LSC	BD	BD2	LB	LF	THID	DBC	CRKS
DIN208050FM40	50	40	27	97.5	88	20.8	36	M12	66.7	M24
DIN208050FM60	50	60	40	128	-	-	35.8	M16	101.6	M24

Option: Wrench for lock screw

Reference pages



DIN2080-SEMC

Combination holder for slot mill and shell mill (DIN2080)

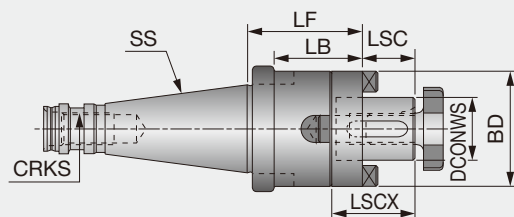

Designation	SS	DCONWS	LSC	BD	LF	LB	LSCX	CRKS
DIN208030SEMC16X35	30	16	17	32	35	25.4	27	M12
DIN208030SEMC22X35	30	22	19	40	35	25.4	31	M12
DIN208030SEMC27X35	30	27	21	48	35	25.4	33	M12
DIN208030SEMC32X50	30	32	24	58	50	40.4	38	M12
DIN208040SEMC22X52	40	22	19	40	52	40.4	31	M16
DIN208040SEMC27X52	40	27	21	48	52	40.4	33	M16
DIN208040SEMC32X52	40	32	24	58	52	40.4	38	M16
DIN208040SEMC40X52	40	40	27	70	52	40.4	41	M16
DIN208050SEMC16X55	50	16	17	32	55	39.8	27	M24
DIN208050SEMC22X55	50	22	19	40	55	39.8	31	M24
DIN208050SEMC27X55	50	27	21	48	55	39.8	33	M24
DIN208050SEMC32X55	50	32	24	58	55	39.8	38	M24
DIN208050SEMC40X55	50	40	27	70	55	39.8	41	M24
DIN208050SEMC50X55	50	50	30	90	55	39.8	46	M24

Option: Wrench for lock screw

DIN2080-DC

Jacobs taper holder (DIN2080)

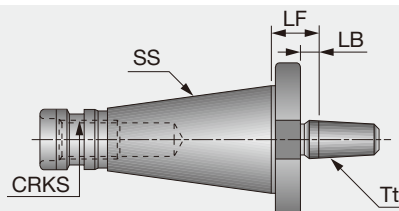

Designation	SS	Tt	LF	LB	CRKS
DIN208030DCB16X20	30	B16	20	5.4	M12
DIN208040DCB16X22	40	B16	22	10.4	M16
DIN208050DCB18X25	50	B18	25	9.8	M24

Reference pages



Pull stud
K146



Clamping screw
K151



Wrench
K153

DIN2080 AD

Conversion adapter (DIN2080)

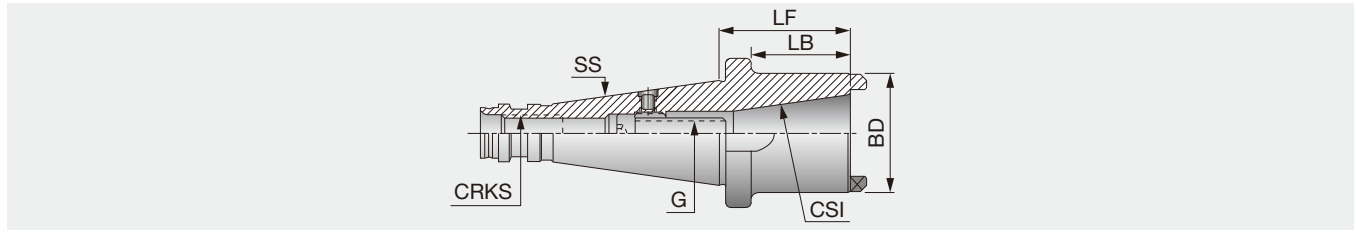

Designation	SS	CSI	LF	BD	LB	G	CRKS
DIN208050AD40	50	DIN2080	50	63	34.8	M16	M24

DIN2080-MT DRW

Morse taper holder with draw bar (DIN2080)

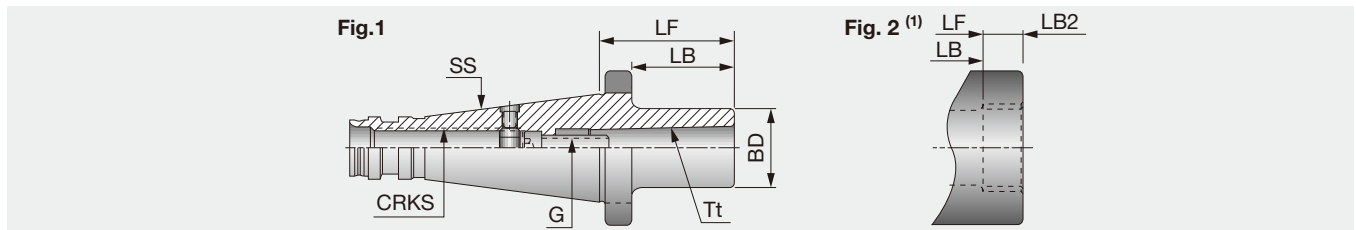

Designation	SS	Tt	LF	BD	LB	LB2	G	CRKS	Fig.
DIN208040MT1DRW	40	MT1	50	25	38.4	-	M6	M16	1
DIN208040MT2DRW	40	MT2	50	32	38.4	-	M10	M16	1
DIN208040MT4DRW	40	MT4	95	63	-	15	M16	M16	2
DIN208050MT1DRW	50	MT1	60	25	44.8	-	M6	M24	1
DIN208050MT2DRW	50	MT2	60	32	44.8	-	M10	M24	1
DIN208050MT3DRW	50	MT3	65	40	49.8	-	M12	M24	1
DIN208050MT4DRW	50	MT4	65	63	49.8	15	M16	M24	2
DIN208050MT5DRW	50	MT5	100	78	84.4	18	M20	M24	2

(1) DIN2201

DIN2080-MT

Morse taper holder (DIN2080)

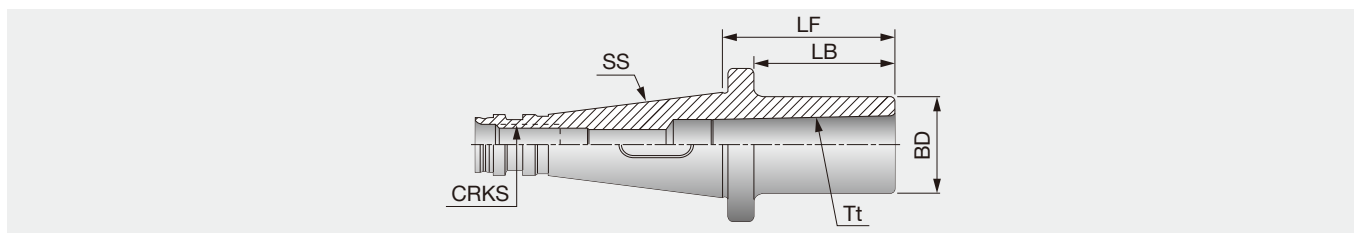

Designation	SS	Tt	LF	BD	LB	CRKS
DIN208040MT1X50	40	MT1	50	25	38.4	M16
DIN208040MT2X50	40	MT2	50	32	38.4	M16
DIN208040MT3X65	40	MT3	65	40	53.4	M16
DIN208040MT4X95	40	MT4	95	48	83.4	M16
DIN208050MT1X45	50	MT1	45	25	29.8	M24
DIN208050MT2X60	50	MT2	60	32	44.8	M24
DIN208050MT3X65	50	MT3	65	40	49.8	M24
DIN208050MT4X70	50	MT4	70	48	54.8	M24
DIN208050MT5X105	50	MT5	105	63.5	89.2	M24

Reference pages



Pull stud

K146

DIN2080-CP

Center plug (DIN2080)

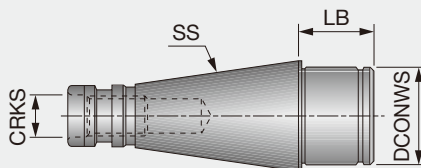

Designation	SS	DCONWS	LB	CRKS
DIN208040CP40	40	40	29	M16
DIN208050CP60	50	60	39	M24

R-8 ER

ER collet chuck holder (R-8 Bridgeport)

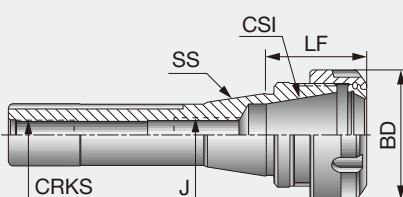

Designation	SS	CSI	Range	LF	BD	J	CRKS
R-8ER16X38	R-8	ER16	0.5-10	38	28	M10	7/16-20
R-8ER32X40	R-8	ER32	2-20	40	50	M12	7/16-20
R-8ER40X72	R-8	ER40	3-26	72	63	M12	7/16-20

- Applicable for 10 MPa coolant

Option: Wrench for ER collet

**ST-ER-M**

ER Mini collet chuck holder (straight shank)

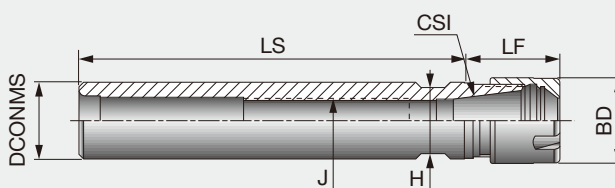

Designation	DCONMS	CSI	Range	LS	LF	J	BD	H
ST12X80ER11M	12	ER11	0.5-7	80	26.5	-	16	11
ST16X50ER11MF	16	ER11	0.5-7	50	18.5	M8	16	13
ST16X100ER11M	16	ER11	0.5-7	100	18.5	M8	16	13
ST16X150ER11M	16	ER11	0.5-7	150	18.5	M8	16	13
ST12X80ER16M	12	ER16	0.5-10	80	36.5	-	22	17
ST20X100ER16M	20	ER16	0.5-10	100	25	M12	22	17
ST20X150ER16M	20	ER16	0.5-10	150	25	M12	22	17
ST20X100ER20M	20	ER20	1-13	100	40	M12	28	21
ST20X150ER20M	20	ER20	1-13	150	40	M12	28	21

- Applicable for 10 MPa coolant
- F indicates a flat on the shank.

Option: Wrench for ER collet

Reference pages



Pull stud

K146

ST-ER

ER collet chuck holder (Straight shank)

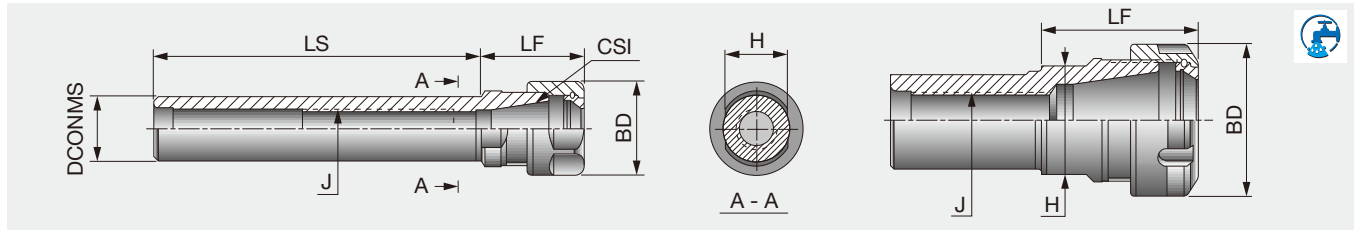





Designation	DCONMS	CSI	Range	LS	LF	J	BD	H
ST16X50ER11F	16	ER11	0.5-7	50	18.5	M8	19	13
ST20X50ER11F	20	ER11	0.5-7	50	18.5	M10	19	17
ST20X100ER11	20	ER11	0.5-7	100	18.5	M10	19	17
ST20X150ER11	20	ER11	0.5-7	150	18.5	M10	19	17
ST20X50ER16F	20	ER16	0.5-10	50	32.3	M12	28	19
ST20X100ER16	20	ER16	0.5-10	100	30	M12	28	19
ST20X150ER16	20	ER16	0.5-10	150	30	M12	28	19
ST20X50ER20F	20	ER20	1-13	50	42.5	M12	34	22
ST25X100ER20	25	ER20	1-13	100	36	M16	34	22
ST25X150ER20	25	ER20	1-13	150	36	M16	34	22
ST20X50ER25F	20	ER25	1-16	50	46	M12	42	28
ST20X100ER25	20	ER25	1-16	100	46	M12	42	28
ST20X50ER32F	20	ER32	2-20	50	54	M12	50	36
ST20X100ER32	20	ER32	2-20	100	54	M12	50	36
ST25X50ER25F	25	ER25	1-16	50	46	M16	42	28
ST25X100ER25	25	ER25	1-16	100	46	M16	42	28
ST25X50ER32F	25	ER32	2-20	50	52	M16x2	50	36
ST25X50ER40F	25	ER40	3-26	50	60	M16x2	63	45
ST30X50ER32F	30	ER32	2-20	50	52	M18x1.5	50	36
ST30X50ER40F	30	ER40	3-26	50	60	M18x1.5	63	45
ST32X50ER32F	32	ER32	2-20	50	52	M18x1.5	50	36
ST32X150ER32	32	ER32	2-20	150	52	M18x1.5	50	36
ST32X50ER40F	32	ER40	3-26	50	60	M18x1.5	63	45
ST40X75ER32F	40	ER32	2-20	75	46	M22x1.5	50	44
ST40X75ER40F	40	ER40	3-26	75	55	M22x1.5	63	45
ST50X80ER40F	50	ER40	3-26	80	60	M28x1.5	63	54
ST50X80ER50F	50	ER50	10-34	80	77	M36x1.5	78	58

- Applicable for 10 MPa coolant
- F indicates a flat on the shank.

Option: Wrench for ER collet

Reference pages

			
ER collet	Nut	Wrench	Preset screw
K124 -	K149	K150	K151

ST-ER-MF

ER Mini collet chuck holder, with flat, for Swiss machines

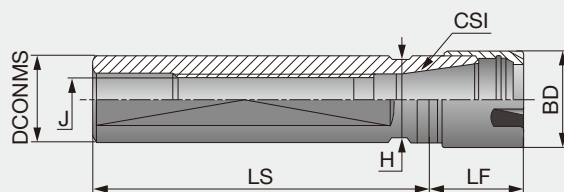

Designation	DCONMS	CSI	Range	LS	LF	J	BD	H	Machine
ST16X35ER16MF	16	ER16	0.5-10	35	36	M8X1	22	17	Citizen
ST16X38ER11MF	16	ER11	0.5-7	38	18.5	M8X1	16	14	Citizen
ST16X140ER11MF	16	ER11	0.5-7	140	18.5	M8X1	16	14	Tsugami, Citizen
ST20X70ER16MF	20	ER16	0.5-10	70	26	M12X1	22	17	Tsugami, Citizen
ST20X120ER16MF	20	ER16	0.5-10	120	26	M12X1	22	17	Tsugami, Citizen
ST20X140ER16MF	20	ER16	0.5-10	140	26	M12X1	22	17	Tsugami, Citizen
ST22X38ER16MF	22	ER16	0.5-10	38	26	M12X1	22	19	Star
ST22X70ER16MF	22	ER16	0.5-10	70	26	M12X1	22	19	Star
ST22X70ER25MF	22	ER25	0.5-16	70	47	M12X1	35	27	Star
ST22X80ER20MF	22	ER20	1-13	80	39	M12X1	28	21	Star
ST22X100ER16MF	22	ER16	1-16	100	28	M12X1	22	19	Star
ST25X65ER16MF	25	ER16	0.5-10	65	28	M12X1	22	22	Tsugami, Citizen
ST25X75ER25MF	25	ER25	1-16	75	48	M14X1	35	27	Tsugami, Citizen
ST25X100ER20MF	25	ER20	1-13	100	28	M14X1	28	22	Tsugami, Citizen
ST25X145ER25MF	25	ER25	1-16	145	36	M14X1	35	27	Tsugami, Citizen
ST25X154ER20MF	25	ER20	1-13	154	28	M14X1	28	22	Tsugami, Citizen
ST32X70ER25MF	32	ER25	1-16	70	30	M18X1	35	27	Citizen, Star

• Applicable for 10 MPa coolant

Option: Wrench for ER collet

ST-ER-MF-D

ER Mini collet chuck holder, double end type

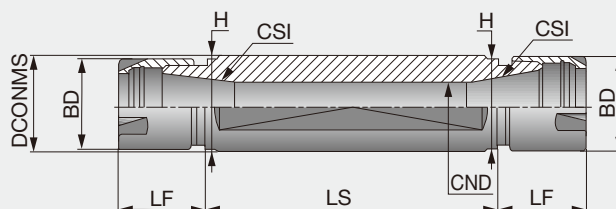

Designation	DCONMS	CSI	Range	LS	LF	BD	CND	H	Machine
ST16X50ER11MFD	16	ER11	0.5-7	50	18.5	16	7.5	14	-
ST20X30ER11MFD	20	ER11	0.5-7	30	18.5	16	7.5	17	Tsugami, Citizen
ST20X50ER11MFD	20	ER11	0.5-7	50	18.5	16	7.5	17	Tsugami, Citizen
ST20X55ER16MFD	20	ER16	0.5-10	55	25	22	10.5	17	Tsugami, Citizen
ST22X55ER16MFD	22	ER16	0.5-10	55	28	22	10.5	19	Star
ST22X75ER16MFD	22	ER16	0.5-10	75	28	22	10.5	19	Star
ST25X62ER16MFD	25	ER16	0.5-10	62	28	22	10.5	22	Tsugami
ST32X55ER20MFD	32	ER20	1-13	55	28	28	13.5	27	Star
ST32X75ER20MFD	32	ER20	1-13	75	28	28	13.5	27	Star

• Applicable for 10 MPa coolant

Option: Wrench for ER collet

Reference pages



ER collet

K124 -



Nut

K149



Wrench

K150



Preset screw

K151

ST-ER-S

ER collet chuck holder, with the capability of internal coolant supply

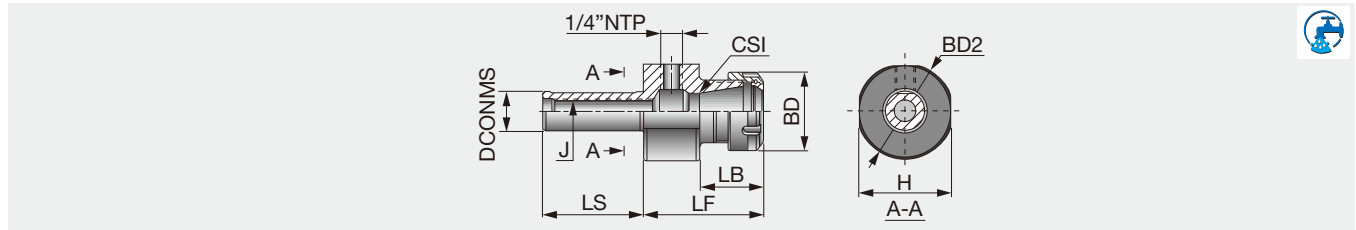

Designation	DCONMS	CSI	Range	LS	LF	LB	J	BD	BD2	H
ST20X65ER20S	20	ER20	1-13	65	63	31	M12	34	40	34
ST20X65ER25S	20	ER25	1-16	65	72	32	M12	42	54	51
ST20X65ER32S	20	ER32	2-20	65	77	41	M12	50	63	59
ST32X65ER32S	32	ER32	2-20	65	77	41	M18x1.5	50	63	59
ST40X75ER32S	40	ER32	2-20	75	77	41	M22x1.5	50	63	59

• Applicable for 10 MPa coolant

Option: Wrench for ER collet

TUNGSHRINK

ST-SRK

Thermal shrinking holder for carbide shank (straight shank)

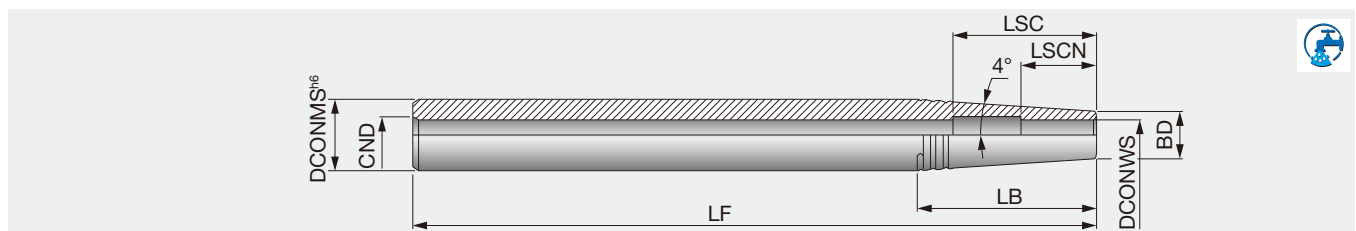

Designation	DCONMS	DCONWS	BD	CND	LF	LB	LSCN	LSC
ST12X160SRK3	12	3	10	4	160	14.3	10	-
ST12X160SRK4	12	4	10	4	160	14.3	12	27
ST16X160SRK3	16	3	10	6	160	43	10	-
ST16X160SRK4	16	4	10	6	160	43	12	-
ST16X160SRK5	16	5	10	6	160	43	15	-
ST16X160SRK6	16	6	11	6	160	35.5	18	35
ST20X200SRK5	20	5	10	6	200	71.5	15	-
ST20X200SRK6	20	6	11	6	200	64.5	18	40
ST20X200SRK8	20	8	14	6	200	43	25	40
ST25X200SRK6	25	6	11	8	200	100	18	35
ST25X200SRK8	25	8	14	8	200	78.6	25	40
ST25X200SRK10	25	10	16	8	200	64.3	30	50
ST25X200SRK12	25	12	20	8	200	35.7	32	52

• Applicable for 10 MPa coolant

Option: Wrench for ER collet

Reference pages

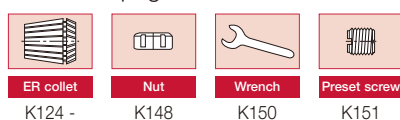

Hydraulic chuck holder (DIN69880)

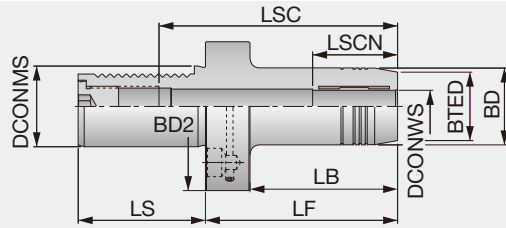

Unit (mm)

Designation	DCONMS	BTED	BD	BD2	DCONWS	LS	LF	LB	LSCN	LSC
DIN69880 30 HYDRO 20X89	20	38	42	68	30	55	89	73	48	85
DIN69880 30 HYDRO 25X100	25	46	50	68	30	55	100	78	54	85
DIN69880 40 HYDRO 20X95	20	38	42	83	40	63	95	73	48	130
DIN69880 40 HYDRO 25X95	25	46	50	83	40	63	95	73	54	130
DIN69880 40 HYDRO 32X95	32	56	60	83	40	63	95	78	58	90

• Applicable for 10 MPa coolant
Available are reduction sleeves for 12, 20, 25 and 32 mm bore diameters.
Chucking forces will significantly reduce if reduction sleeves are used (ordered separately).

Option: Wrench for TungHydro collet

TUNG GTI

GTI-ER-ST

Tapping holder (straight shank)

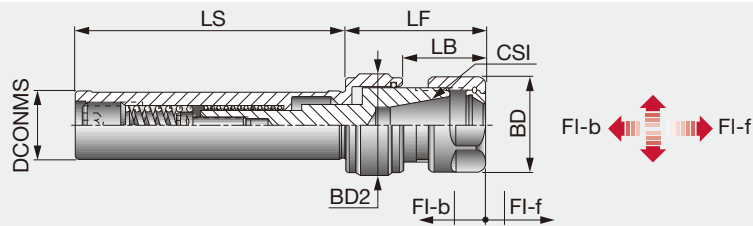

Designation	DCONMS	CSI	Tap min	Tap max	Range	BD	BD2	LB	LF	LS	FI-f	FI-b
GTIER11ST16X150M	16	ER11	M2	M7	0.5-7	16	-	19	-	150	6	3
GTIER16ST20X80	20	ER16	M3	M10	0.5-10	28	29.5	24.6	41.6	80	8	3
GTIER20ST20X80	20	ER20	M4	M14	1-13	34	33.5	28	49	80	8	3
GTIER25ST25X80	25	ER25	M5	M16	1-16	42	40.5	32	53	80	9	4
GTIER32ST25X80	25	ER32	M6	M20	1-16	50	56.5	32	77.2	80	9	4
GTIER40ST32X80	32	ER40	M6	M27	2-20	63	56.5	51	95.2	80	9	4

Option: Wrench for ER collet

KIT GTI-ER-ST

ER tapping holder and spring collets (straight shank)

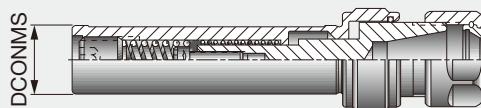

Designation	Collet size	DCONMS	Qty	Range
KITGTIER11ST16X1504M	ER11	16	4	3,4,5,6
KITGTIER16ST20X804	ER16	20	4	4,5,6,7
KITGTIER20ST20X804	ER20	20	4	5,6,7,8
KITGTIER25ST25X805	ER25	25	5	6,7,9,11,12
KITGTIER32ST25X806	ER32	25	6	6,7,9,11,12,16
KITGTIER40ST32X806	ER40	32	6	9,11,14,16,18,20

Includes GTI collets and wrench

Reference pages



ER collet

K124 -



Nut

K149



Wrench

K150



Preset screw

K151

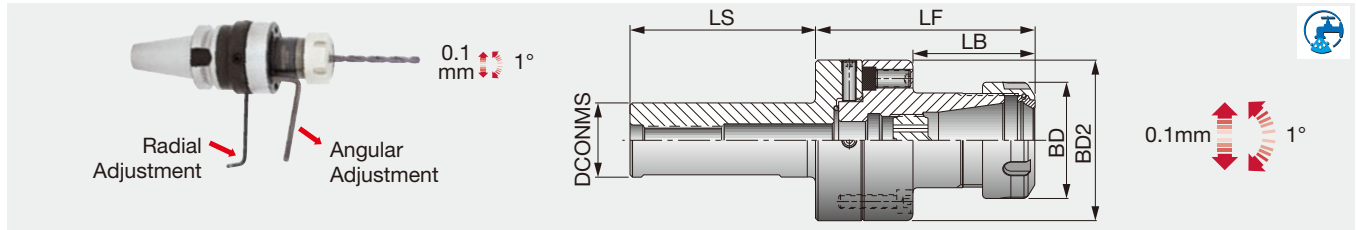

Designation	Range	LF	LB	LS	BD	BD2	DCONMS
ADJST25D70ER32	2-20	94.5	52.5	80	50	70	25
ADJST32D70ER32	2-20	94.5	52.5	80	50	70	32

• Applicable for 10 MPa coolant Option: Wrench for ER collet

MT-ER

ER collet chuck holder with Morse taper

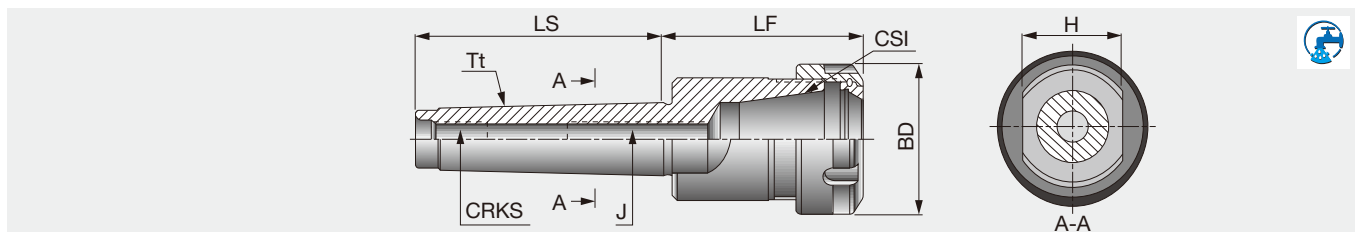

Designation	Tt	CSI	Range	LF	LS	BD	J	CRKS	H
MT2ER20X48.5	MT 2	ER20	1-13	48.5	64	34	M10	M10	22
MT2ER25X52	MT 2	ER25	1-16	52	64	42	M10	M10	28
MT3ER32X69	MT 3	ER32	2-20	69	81	50	M12	M12	24
MT3ER40X79	MT 3	ER40	3-26	79	81	63	M12	M12	24
MT4ER32X61	MT 4	ER32	2-20	60.5	102.5	50	M16	M16	32
MT4ER40X82	MT 4	ER40	3-26	81.5	102.5	63	M16	M16	32
MT4ER50X108	MT 4	ER50	10-34	107.5	102.5	78	M16	M16	32
MT5ER40X82	MT 5	ER40	3-26	82	129.5	63	M28x1.5	M20	45
MT5ER50X85	MT 5	ER50	10-34	85	129.5	78	M28x1.5	M20	45

• Applicable for 3 MPa coolant Option: Wrench for ER collet

TUNGGYRO

GYRO ST-ER TungGYRO

Collet chuck holder with center alignment, for lathes

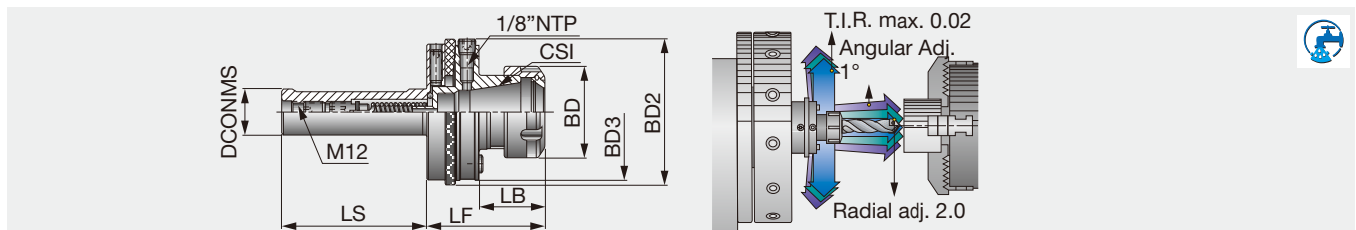

Designation	DCONMS	CSI	Range	LF	LB	LS	BD	BD3	BD2
GYROST25ER25	25	ER25	1-16	65.65	35.5	80	42	74	79
GYROST40ER32	40	ER32	2-20	66.65	36.5	80	50	74	79

• Applicable for 3 MPa coolant Option: Wrench for ER collet
 For the alignment, first-time users should purchase a TungGyro kit which includes a test bar and a bushing.

Reference pages

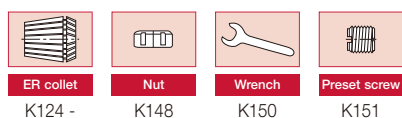

K124 - K148 K150 K151



Kit for holders with center alignment (straight shank)

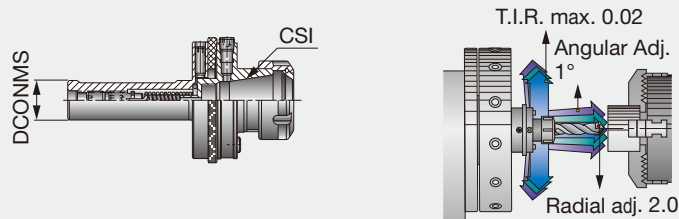

Designation	DCONMS	CSI	Range
KITGYROST20ER25	20	ER25	1-16
KITGYROST25ER25	25	ER25	1-16
KITGYROST40ER32	40	ER32	2-20

• Applicable for 3 MPa coolant
Kit includes TungGyro holder, test bar, and bushing.

Option: Wrench for ER collet

KIT GYRO-DIN69880-ER

Kit for holders with center alignment (DIN69880)

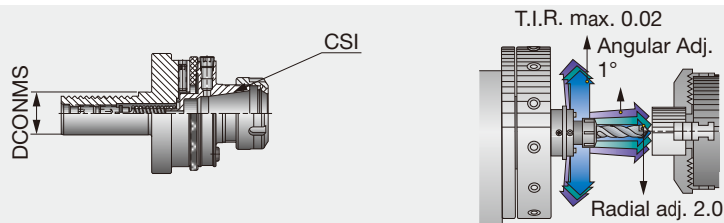

Designation	DCONMS	CSI	Range
KITGYRO30D69880ER25	30	ER25	1-16
KITGYRO30D69880ER32	30	ER32	2-20
KITGYRO40D69880ER32	40	ER32	2-20
KITGYRO50D69880ER32	50	ER32	2-20

• Applicable for 3 MPa coolant
Kit includes TungGyro holder, test bar, and bushing.

Option: Wrench for ER collet

Side lock

Collet chuck

Face mill

Milling chuck

Hydro chuck

Shrinking chuck

Others

Reference pages



ER collet

K124 -



Nut

K148



Wrench

K150



Preset screw

K151

Floating reamer collet chuck

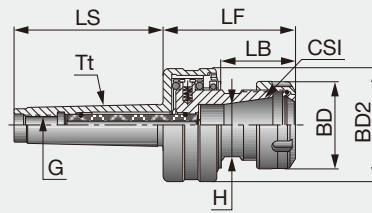

Designation	Tt	CSI	Range	LS	LF	LB	BD	BD2	Radial float	H	G
GFIMT2ER20	MT 2	ER20	1-13	64	60.5	34.5	34	50	1	22	M10
GFIMT3ER32	MT 3	ER32	2-20	81	81.9	45.9	50	65	1.6	36	M12

• Applicable for 3 MPa coolant
Maximum 2000 min⁻¹

Option: Wrench for ER collet

GFI-ST-ER

Floating reamer collet chuck

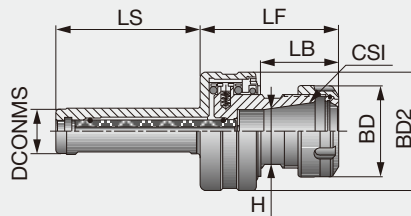

Designation	DCONMS	CSI	Range	LS	LF	LB	BD	BD2	Radial float	H
GFIST20ER20	20	ER20	1-13	65	55.5	34.5	34	50	1	22
GFIST25ER32	25	ER32	2-20	80	76.9	45.9	50	65	1.6	36

• Applicable for 3 MPa coolant
Maximum 2000 min⁻¹

Option: Wrench for ER collet

Reference pages



ER collet

K124 -



Nut

K148



Wrench

K150



Preset screw

K151

Steel modular shank

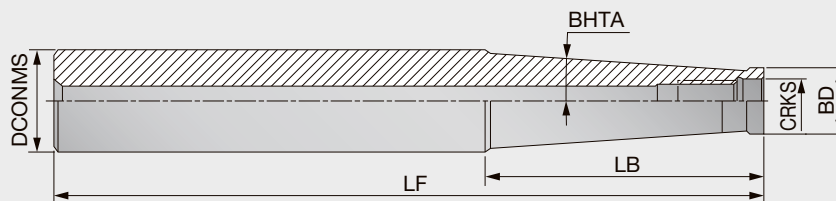

Designation	DCONMS	BD	LF	LB	BHTA	CRKS
SM06-L60C10	10	9.7	60	20	0°	M6
SM06-L105-C12	12	9.7	105	60	1.2°	M6
SM06-L125-C16	16	9.7	125	60	3.3°	M6
SM08-L73C16	16	13	73	25	0°	M8
SM08-L128-C16	16	13	128	80	0.9°	M8
SM08-L170-C20	20	13	170	66.8	3.3°	M8
SM10-L80C20	20	18	80	30	0°	M10
SM10-L130-C20	20	18	130	80	0.6°	M10
SM10-L200-C25	25	19	200	57.2	3.3°	M10
SM12-L86-C25	25	21	86	30	5.1°	M12
SM12-L200-C32	32	21	200	78	4.4°	M12
SM16-L95-C32	32	29	95	35	1.7°	M16
SM16-L230-C32	32	29	230	50	1.8°	M16

• Applicable for 10 MPa coolant
A coolant hole with all types of shanks

SM-C-H

Carbide modular shank

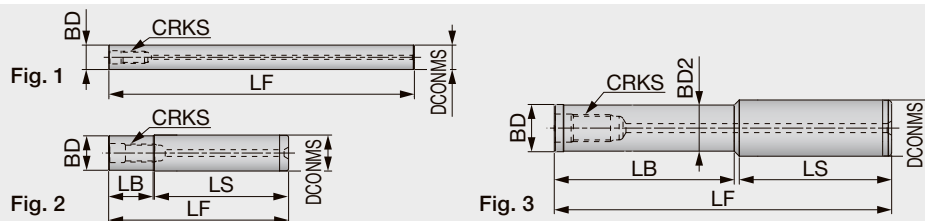

Designation	CRKS	DCONMS	LF	LB	LS	BD	BD2	Fig.
SM06-L100-C10-C-H	M6	10	100	-	-	10	-	1
SM06-L150-C10-C-H	M6	10	150	-	-	10	-	1
SM06-L100-C12-C-H	M6	12	100	-	-	12	-	1
SM06-L150-C12-C-H	M6	12	150	-	-	12	-	1
SM08-L80-20-C16-C-H	M8	16	80	20	59.6	15.3	-	2
SM08-L100-40-C16-C-H	M8	16	100	40	59.6	15.3	-	2
SM08-L150-80-C16-C-H	M8	16	150	80	69.6	15.3	-	2
SM08-L200-100-C16-C-H	M8	16	200	100	98.2	13	12.5	3
SM08-L200-140-C16-C-H	M8	16	200	140	59.6	15.3	-	2
SM08-L250-180-C16-C-H	M8	16	250	180	69.6	15.3	-	2
SM10-L80-20-C20-C-H	M10	20	80	20	59.2	18.5	-	2
SM10-L100-40-C20-C-H	M10	20	100	40	59.2	18.5	-	2
SM10-L150-80-C20-C-H	M10	20	150	80	69.2	18.5	-	2
SM10-L200-100-C20-C-H	M10	20	200	100	99.2	18.5	-	2
SM10-L200-140-C20-C-H	M10	20	200	140	58.7	18	17.5	3
SM10-L200-140-C20-C-H-N	M10	20	200	140	59.2	18.5	-	2
SM10-L250-130-C20-C-H	M10	20	250	130	118.7	18	17.5	3
SM10-L250-180-C20-C-H	M10	20	250	180	68.7	18	17.5	3
SM10-L250-180-C20-C-H-N	M10	20	250	180	69.2	18.5	-	2
SM10-L300-180-C20-C-H	M10	20	300	180	118.7	18	17.5	3
SM10-L300-230-C20-C-H	M10	20	300	230	68.7	18	17.5	3
SM12-L100-40-C25-C-H	M12	25	100	40	59.5	24	-	2
SM12-L150-80-C25-C-H	M12	25	150	80	67.7	21	20.5	3
SM12-L150-80-C25-C-H-N	M12	25	150	80	69.5	24	-	2
SM12-L200-100-C25-C-H	M12	25	200	100	97.7	21	20.5	3
SM12-L200-100-C25-C-H-N	M12	25	200	100	99.5	24	-	2

Designation	CRKS	DCONMS	LF	LB	LS	BD	BD2	Fig.
SM12-L200-140-C25-C-H	M12	25	200	140	57.7	21	20.5	3
SM12-L250-130-C25-C-H	M12	25	250	130	117.7	21	20.5	3
SM12-L250-180-C25-C-H	M12	25	250	180	69.5	24	-	2
SM12-L300-180-C25-C-H	M12	25	300	180	117.7	21	20.5	3
SM12-L300-180-C25-C-H-N	M12	25	300	180	119.5	24	-	2
SM12-L300-230-C25-C-H	M12	25	300	230	67.7	21	20.5	3
SM16-L100-40-C32-C-H	M16	32	100	40	58.5	29	-	2
SM16-L150-80-C32-C-H	M16	32	150	80	68.5	29	-	2
SM16-L200-100-C32-C-H	M16	32	200	100	98.5	29	-	2
SM16-L200-140-C32-C-H	M16	32	200	140	58.5	29	-	2
SM16-L250-130-C32-C-H	M16	32	250	130	118.5	29	-	2
SM16-L250-180-C32-C-H	M16	32	250	180	68.5	29	-	2
SM16-L300-180-C32-C-H	M16	32	300	180	118.5	29	-	2
SM16-L300-230-C32-C-H	M16	32	300	230	68.5	29	-	2
SM16-L350-230-C32-C-H	M16	32	350	230	118.5	29	-	2
SM16-L350-280-C32-C-H	M16	32	350	280	68.5	29	-	2

TUNGFIT TUNGFLEX

SM-CF4 TungFit adaptor

TungFlex - TungFit conversion adaptor

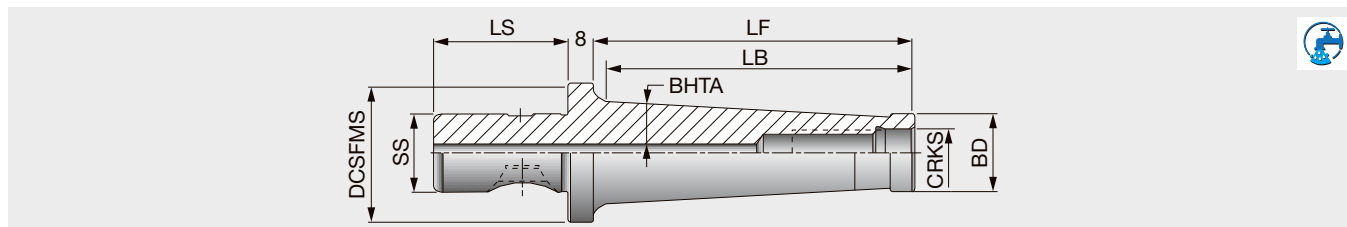

Designation	BD	LF	LB	BHTA	SS	DCSFMS	LS	CRKS
SM12-L85/3.30-CF4	21	93	81.3	4.4°	CF4	44	42	M12
SM16-L130/5.11-CF4	29	138	126.8	2.6°	CF4	44	42	M16
SM12-L140/5.50-CF4	21	148	139.1	4.4°	CF4	44	42	M12
SM16-L170/6.70-CF4	29	178	168.6	2°	CF4	44	42	M16

• Applicable for 10 MPa coolant

TUNGFLEX

CAB M-M

Reducer and extension

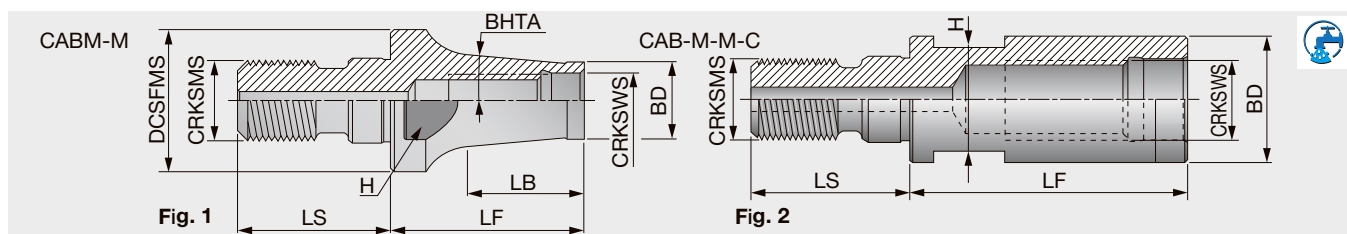

Designation	CRKSMS	BHTA	BD	LF	LB	DCSFMS	LS	H	CRKSWS	Fig.
CABM06M08	M8	5.7°	9.7	30	24.8	13	17.5	9.5	M6	1
CABM08M08-C	M8	0°	13	30	-	-	17.5	9.6	M8	2
CABM08M10	M10	5.2°	13	40	33.4	18	20	15	M8	1
CABM10M10-C	M10	0°	18	35	-	-	20	15	M10	2
CABM10M12	M12	2.5°	18	45	36.4	21	22	17	M10	1
CABM12M12-C	M12	0°	21	40	-	-	22	17	M12	2
CABM12M16	M16	6.3°	21	50	42.5	29	25	25	M12	1
CABM16M16-C	M16	0°	29	40	-	-	25	25	M16	2

Applicable for 10 MPa coolant

Reference pages

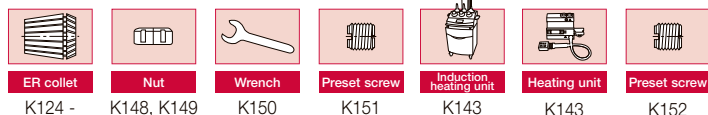

K124 - K148, K149 K150 K151 K143 K143 K152

ER collet chuck holder

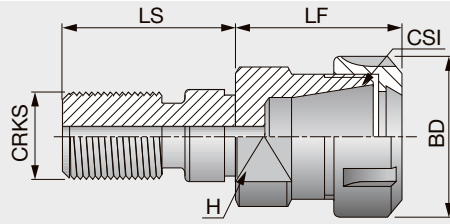

Designation	CRKS	CSI	Range	LF	LS	BD	H
CDPER11M10M	M10	ER11	0.5-7	27	20	16	15
CDPER16M10M	M10	ER16	0.5-10	38.1	20	22	17
CDPER11M12M	M12	ER11	0.5-7	27	22	16	17
CDPER16M12M	M12	ER16	0.5-10	37.1	22	22	17
CDPER16M16	M16	ER16	0.5-10	36.6	25	28	25
CDPER20M16	M16	ER20	1-13	45.5	25	34	25
CDPER25M16	M16	ER25	1-16	44.5	25	42	28

• Applicable for 10 MPa coolant

Option: Wrench for ER collet

CDP-M-SRK

Thermal shrinking holder for carbide shank

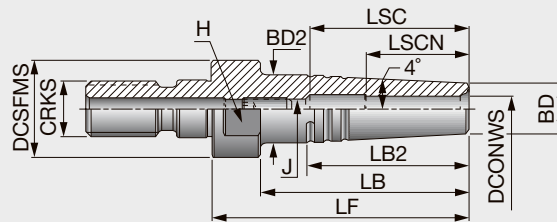

Designation	CRKS	DCSFMS	DCONWS	BD	BD2	LF	LB	LB2	LSCN	LSC	J	H	Wrench
CDPM10SRK3X40	M10	18	3	10	14	40	31.5	28.4	10	16	M4	15	2
CDPM10SRK4X40	M10	18	4	10	14	40	31.5	28.4	12	19	M4	15	2
CDPM10SRK5X40	M10	18	5	10	14	40	31.5	28.4	15	25	M4	15	2
CDPM12SRK3X45	M12	21	3	10	14	45	36.5	28.8	10	16	M5	18	2.5
CDPM12SRK4X45	M12	21	4	10	14	45	36.5	28.8	12	18	M5	18	2.5
CDPM12SRK5X45	M12	21	5	10	14	45	36.5	28.8	15	25	M5	18	2.5
CDPM12SRK6X45	M12	21	6	11	15	45	36.5	28.4	18	28	M5	18	2.5
CDPM12SRK8X45	M12	21	8	14	18	45	36.5	28.8	25	35	M5	18	2.5
CDPM12SRK10X45	M12	21	10	16	21	45	-	35.6	30	40	M5	18	2.5
CDPM12SRK12X45	M12	21	12	20	25	45	-	36.0	32	42	M5	18	2.5

• Applicable for 10 MPa coolant

Reference pages



Wrench

K150



Preset screw

K151



Induction heating unit

K143



Heating unit

K143



Preset screw

K152

Extension adapter

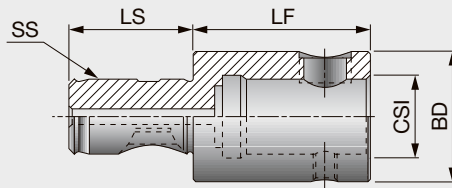

Designation	SS	LS	LF	CSI	BD
EXCF4-S	CF4	42	60	CF4	44
EXCF4-L	CF4	42	100	CF4	44

• Applicable for 10 MPa coolant
Tightening torque: 58.8 N-m.

SEM-CF

Shell mill adapter

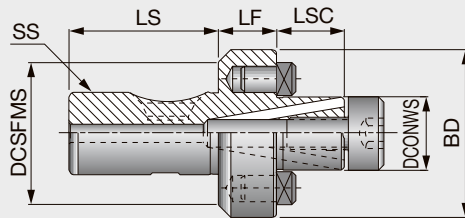

Designation	SS	DCONWS	DCSFMS	BD	LF	LSC	LS
SEM22CF4C	CF4	22	44	47	16	19	42

• Applicable for 10 MPa coolant
Tightening torque: 58.8 N-m.

Option: Wrench for Lock Screw

ER-CF

ER collet chuck adapter

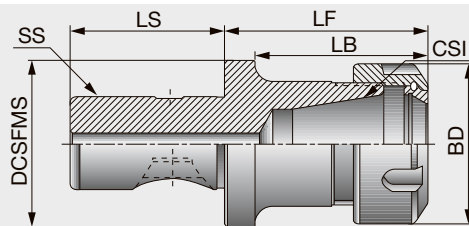

Designation	SS	CSI	Range	LF	LB	LS	BD	DCSFMS
ER11CF4-S	CF4	ER11	0.5-7	55	47	42	19	44
ER16CF4-L	CF4	ER16	0.5-10	100	92	42	28	44
ER16CF4-S	CF4	ER16	0.5-10	55	47	42	28	44
ER20CF4-S	CF4	ER20	1-13	55	92	42	34	44
ER32CF4-L	CF4	ER32	2-20	100	92	42	50	44
ER32CF4-S	CF4	ER32	2-20	55	47	42	50	44

• Applicable for 10 MPa coolant
Tightening torque: 58.8 N-m.

Option: Wrench for Lock Screw

Reference pages



ER collet

K124 -



Nut

K148



Wrench

K150

Shanks

BT MAS-403



ST Straight Shank



MT Morse Taper

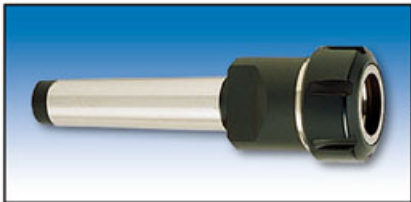

Collet Options

ER Spring Collet



ER-SEAL (ER SEAL Collet for Internal coolant)

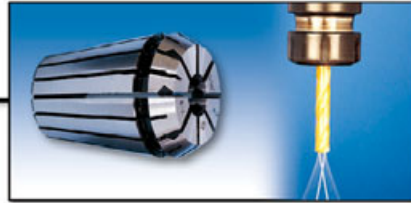

ER-SEAL JET2 (ER SEAL Collet for External coolant)



ER-SHRINK (ER Collet with SHRINK Holder)



ER GTI (ER Collet with Tapping Holder)



ER-ODP (ER Collet with Indexable Modular System)



- TUNGCAP
- TUNGHOLD
- SPINJET
- SWISSBORE
- Others
- DIN 69871
- HSK
- BT MAS
- DIN 2080
- Others
- Side lock
- Collet chuck
- Face mill
- Milling chuck
- Hydro chuck
- Shrinking chuck
- Others

ER Collet standard DIN6499

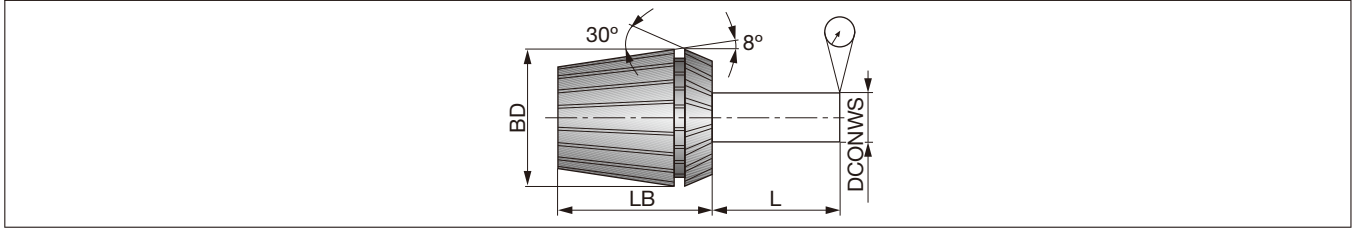

Collet size	BD	LB	L	DCONWS	T.I.R. Precision		DIN6499
					Standard type	AA ultra precision type	
ER11	11.5	18	6	1-1.6	0.01	0.005	-
ER16	17	27	10	1.6-3	0.01	0.005	0.015
ER20	21	31	16	3-6	0.01	0.005	0.015
ER25	26	35	25	6-10	0.01	0.005	0.015
ER32	33	40	40	10-18	0.01	0.005	0.020
ER40	41	46	50	18-26	0.01	0.005	0.020
ER50	52	60	60	26-34	0.01	-	0.025

ER - Coolit Sealed Collet



For internal coolant holders Sealed Collet - JET
For straight shank cutting tools with internal coolant supply.

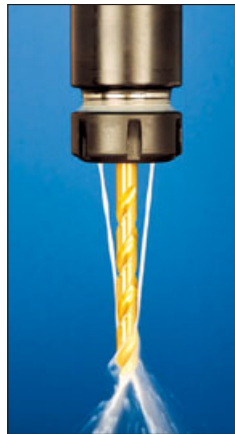

For External coolant holders Sealed Collet - JET2
With angular double nozzles. Coolant flow is direct to the cutting edge - for use with standard straight shank cutting tools (without coolant hole)

Standard Shank which can be used in Sealed Collets

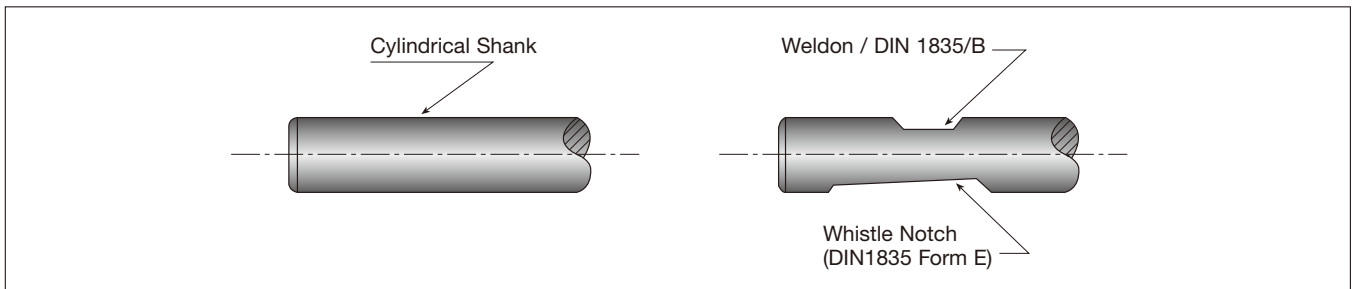

Note: The front end of the sealed collet should be located beyond Weldon or the whistle notch.

ER-SPR

ER spring collets (Metric, DIN6499)

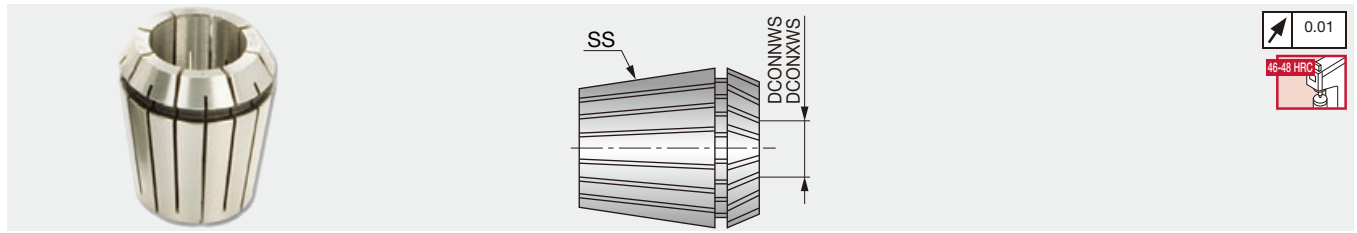

Designation	SS	DCONNWS	DCONXWS	Designation	SS	DCONNWS	DCONXWS
ER11SPR0.5-1.0	ER11	0.5	1	ER32SPR2-3	ER32	2	3
ER11SPR1.0-1.5	ER11	1	1.5	ER32SPR3-4	ER32	3	4
ER11SPR1.5-2.0	ER11	1.5	2	ER32SPR4-5	ER32	4	5
ER11SPR2.0-2.5	ER11	2	2.5	ER32SPR5-6	ER32	5	6
ER11SPR2.5-3.0	ER11	2.5	3	ER32SPR6-7	ER32	6	7
ER11SPR3.0-3.5	ER11	3	3.5	ER32SPR7-8	ER32	7	8
ER11SPR3.5-4.0	ER11	3.5	4	ER32SPR8-9	ER32	8	9
ER11SPR4.0-4.5	ER11	4	4.5	ER32SPR9-10	ER32	9	10
ER11SPR4.5-5.0	ER11	4.5	5	ER32SPR10-11	ER32	10	11
ER11SPR5.0-5.5	ER11	5	5.5	ER32SPR11-12	ER32	11	12
ER11SPR5.5-6.0	ER11	5.5	6	ER32SPR12-13	ER32	12	13
ER11SPR6.0-6.5	ER11	6	6.5	ER32SPR13-14	ER32	13	14
ER11SPR6.5-7.0	ER11	6.5	7	ER32SPR14-15	ER32	14	15
ER16SPR0.5-1	ER16	0.5	1	ER32SPR15-16	ER32	15	16
ER16SPR1-1.5	ER16	1	1.5	ER32SPR16-17	ER32	16	17
ER16SPR1.5-2	ER16	1.5	2	ER32SPR17-18	ER32	17	18
ER16SPR2-3 (*)	ER16	2	3.1	ER32SPR18-19	ER32	18	19
ER16SPR3-4 (*)	ER16	3.2	4	ER32SPR19-20	ER32	19	20
ER16SPR4-5	ER16	4	5	ER40SPR3-4	ER40	3	4
ER16SPR5-6	ER16	5	6	ER40SPR4-5	ER40	4	5
ER16SPR6-7	ER16	6	7	ER40SPR5-6	ER40	5	6
ER16SPR7-8	ER16	7	8	ER40SPR6-7	ER40	6	7
ER16SPR8-9	ER16	8	9	ER40SPR7-8	ER40	7	8
ER16SPR9-10	ER16	9	10	ER40SPR8-9	ER40	8	9
ER20SPR1-1.5	ER20	1	1.5	ER40SPR9-10	ER40	9	10
ER20SPR1.5-2	ER20	1.5	2	ER40SPR10-11	ER40	10	11
ER20SPR2-3	ER20	2	3	ER40SPR11-12	ER40	11	12
ER20SPR3-4	ER20	3	4	ER40SPR12-13	ER40	12	13
ER20SPR4-5	ER20	4	5	ER40SPR13-14	ER40	13	14
ER20SPR5-6	ER20	5	6	ER40SPR14-15	ER40	14	15
ER20SPR6-7	ER20	6	7	ER40SPR15-16	ER40	15	16
ER20SPR7-8	ER20	7	8	ER40SPR16-17	ER40	16	17
ER20SPR8-9	ER20	8	9	ER40SPR17-18	ER40	17	18
ER20SPR9-10	ER20	9	10	ER40SPR18-19	ER40	18	19
ER20SPR10-11	ER20	10	11	ER40SPR19-20	ER40	19	20
ER20SPR11-12	ER20	11	12	ER40SPR20-21	ER40	20	21
ER20SPR12-13	ER20	12	13	ER40SPR21-22	ER40	21	22
ER25SPR1-1.5	ER25	1	1.5	ER40SPR22-23	ER40	22	23
ER25SPR1.5-2	ER25	1.5	2	ER40SPR23-24	ER40	23	24
ER25SPR2-3	ER25	2	3	ER40SPR24-25	ER40	24	25
ER25SPR3-4	ER25	3	4	ER40SPR25-26	ER40	25	26
ER25SPR4-5	ER25	4	5	ER50SPR10-12	ER50	10	12
ER25SPR5-6	ER25	5	6	ER50SPR12-14	ER50	12	14
ER25SPR6-7	ER25	6	7	ER50SPR14-16	ER50	14	16
ER25SPR7-8	ER25	7	8	ER50SPR16-18	ER50	16	18
ER25SPR8-9	ER25	8	9	ER50SPR18-20	ER50	18	20
ER25SPR9-10	ER25	9	10	ER50SPR20-22	ER50	20	22
ER25SPR10-11	ER25	10	11	ER50SPR22-24	ER50	22	24
ER25SPR11-12	ER25	11	12	ER50SPR24-26	ER50	24	26
ER25SPR12-13	ER25	12	13	ER50SPR26-28	ER50	26	28
ER25SPR13-14	ER25	13	14	ER50SPR28-30	ER50	28	30
ER25SPR14-15	ER25	14	15	ER50SPR30-32	ER50	30	32
ER25SPR15-16	ER25	15	16	ER50SPR32-34	ER50	32	34

(*) For shank diameter $\phi 3 - \phi 3.1$ use "ER16SPR2-3"

(Unit: mm)

ER-SPR-AA

ER spring AA collets (Metric, DIN6499)

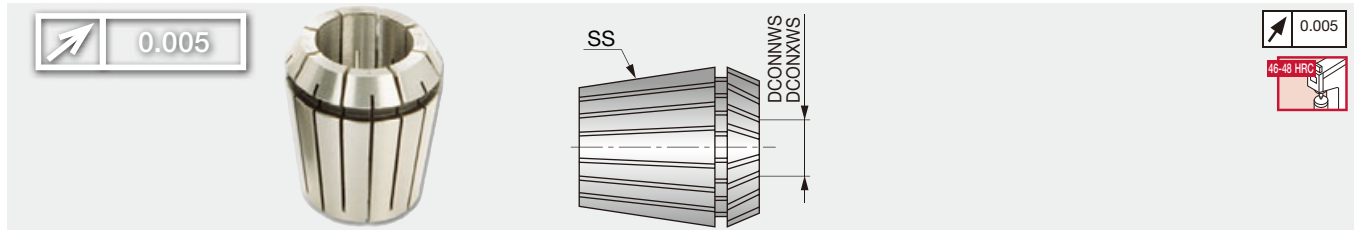

Designation	SS	DCONNWS	DCONXWS	Designation	SS	DCONNWS	DCONXWS
ER11SPR0.5-1.0AA	ER11	0.5	1	ER25SPR12-13AA	ER25	12	13
ER11SPR1.0-1.5AA	ER11	1	1.5	ER25SPR13-14AA	ER25	13	14
ER11SPR1.5-2.0AA	ER11	1.5	2	ER25SPR14-15AA	ER25	14	15
ER11SPR2.0-2.5AA	ER11	2	2.5	ER25SPR15-16AA	ER25	15	16
ER11SPR2.5-3.0AA	ER11	2.5	3	ER32SPR2-3AA	ER32	2	3
ER11SPR3.0-3.5AA	ER11	3	3.5	ER32SPR3-4AA	ER32	3	4
ER11SPR3.5-4.0AA	ER11	3.5	4	ER32SPR4-5AA	ER32	4	5
ER11SPR4.0-4.5AA	ER11	4	4.5	ER32SPR5-6AA	ER32	5	6
ER11SPR4.5-5.0AA	ER11	4.5	5	ER32SPR6-7AA	ER32	6	7
ER11SPR5.0-5.5AA	ER11	5	5.5	ER32SPR7-8AA	ER32	7	8
ER11SPR5.5-6.0AA	ER11	5.5	6	ER32SPR8-9AA	ER32	8	9
ER11SPR6.0-6.5AA	ER11	6	6.5	ER32SPR9-10AA	ER32	9	10
ER11SPR6.5-7.0AA	ER11	6.5	7	ER32SPR10-11AA	ER32	10	11
ER16SPR0.5-1AA	ER16	0.5	1	ER32SPR11-12AA	ER32	11	12
ER16SPR1.5-2AA	ER16	1.5	2	ER32SPR12-13AA	ER32	12	13
ER16SPR2-3AA (*)	ER16	2	3.1	ER32SPR13-14AA	ER32	13	14
ER16SPR3-4AA (*)	ER16	3.2	4	ER32SPR14-15AA	ER32	14	15
ER16SPR4-5AA	ER16	4	5	ER32SPR15-16AA	ER32	15	16
ER16SPR5-6AA	ER16	5	6	ER32SPR16-17AA	ER32	16	17
ER16SPR6-7AA	ER16	6	7	ER32SPR17-18AA	ER32	17	18
ER16SPR7-8AA	ER16	7	8	ER32SPR18-19AA	ER32	18	19
ER16SPR8-9AA	ER16	8	9	ER32SPR19-20AA	ER32	19	20
ER16SPR9-10AA	ER16	9	10	ER40SPR3-4AA	ER40	3	4
ER20SPR1.5-2AA	ER20	1.5	2	ER40SPR4-5AA	ER40	4	5
ER20SPR2-3AA	ER20	2	3	ER40SPR5-6AA	ER40	5	6
ER20SPR3-4AA	ER20	3	4	ER40SPR6-7AA	ER40	6	7
ER20SPR4-5AA	ER20	4	5	ER40SPR7-8AA	ER40	7	8
ER20SPR5-6AA	ER20	5	6	ER40SPR8-9AA	ER40	8	9
ER20SPR6-7AA	ER20	6	7	ER40SPR9-10AA	ER40	9	10
ER20SPR7-8AA	ER20	7	8	ER40SPR10-11AA	ER40	10	11
ER20SPR8-9AA	ER20	8	9	ER40SPR11-12AA	ER40	11	12
ER20SPR9-10AA	ER20	9	10	ER40SPR12-13AA	ER40	12	13
ER20SPR10-11AA	ER20	10	11	ER40SPR13-14AA	ER40	13	14
ER20SPR11-12AA	ER20	11	12	ER40SPR14-15AA	ER40	14	15
ER20SPR12-13AA	ER20	12	13	ER40SPR15-16AA	ER40	15	16
ER25SPR1.5-2AA	ER25	1.5	2	ER40SPR16-17AA	ER40	16	17
ER25SPR2-3AA	ER25	2	3	ER40SPR17-18AA	ER40	17	18
ER25SPR3-4AA	ER25	3	4	ER40SPR18-19AA	ER40	18	19
ER25SPR4-5AA	ER25	4	5	ER40SPR19-20AA	ER40	19	20
ER25SPR5-6AA	ER25	5	6	ER40SPR20-21AA	ER40	20	21
ER25SPR6-7AA	ER25	6	7	ER40SPR21-22AA	ER40	21	22
ER25SPR7-8AA	ER25	7	8	ER40SPR22-23AA	ER40	22	23
ER25SPR8-9AA	ER25	8	9	ER40SPR23-24AA	ER40	23	24
ER25SPR9-10AA	ER25	9	10	ER40SPR24-25AA	ER40	24	25
ER25SPR10-11AA	ER25	10	11	ER40SPR25-26AA	ER40	25	26
ER25SPR11-12AA	ER25	11	12				

(*) For shank diameter $\phi 3 - \phi 3.1$ use *ER16SPR2-3AA*

(Unit: mm)

Grade A
 Insert B
 Ext. Toolholder C
 Int. Toolholder D
 Threading E
 Grooving F
 Miniature tool G
 Milling cutter H
 Endmill I
 Drilling tool J
 Tooling System K
 User's Guide L
 Index M

ER-SEAL-AA

ER sealed spring collets (metric)

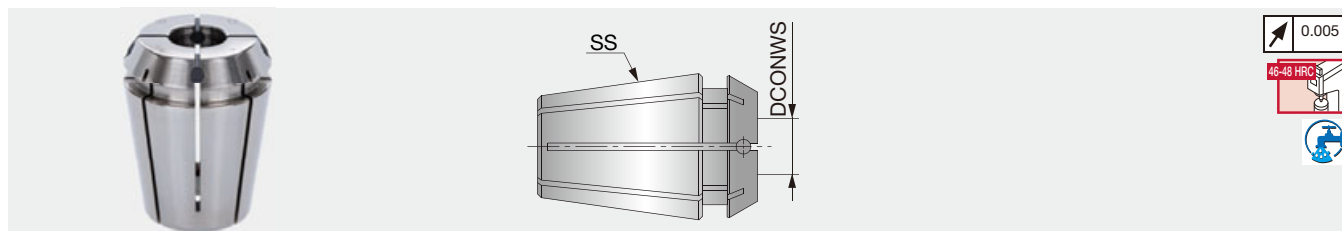

Designation	SS	DCONWS	Designation	SS	DCONWS
ER11SEAL3AA	ER11	3	ER25SEAL14AA	ER25	14
ER11SEAL4AA	ER11	4	ER25SEAL15AA	ER25	15
ER11SEAL5AA	ER11	5	ER25SEAL16AA	ER25	16
ER11SEAL6AA	ER11	6	ER32SEAL4AA	ER32	4
ER16SEAL4AA	ER16	4	ER32SEAL5AA	ER32	5
ER16SEAL5AA	ER16	5	ER32SEAL6AA	ER32	6
ER16SEAL6AA	ER16	6	ER32SEAL7AA	ER32	7
ER16SEAL7AA	ER16	7	ER32SEAL8AA	ER32	8
ER16SEAL8AA	ER16	8	ER32SEAL9AA	ER32	9
ER16SEAL9AA	ER16	9	ER32SEAL10AA	ER32	10
ER16SEAL10AA	ER16	10	ER32SEAL11AA	ER32	11
ER20SEAL4AA	ER20	4	ER32SEAL12AA	ER32	12
ER20SEAL5AA	ER20	5	ER32SEAL13AA	ER32	13
ER20SEAL6AA	ER20	6	ER32SEAL14AA	ER32	14
ER20SEAL7AA	ER20	7	ER32SEAL15AA	ER32	15
ER20SEAL8AA	ER20	8	ER32SEAL16AA	ER32	16
ER20SEAL9AA	ER20	9	ER32SEAL17AA	ER32	17
ER20SEAL10AA	ER20	10	ER32SEAL18AA	ER32	18
ER20SEAL11AA	ER20	11	ER32SEAL19AA	ER32	19
ER20SEAL12AA	ER20	12	ER32SEAL20AA	ER32	20
ER25SEAL4AA	ER25	4	ER40SEAL6AA	ER40	6
ER25SEAL5AA	ER25	5	ER40SEAL8AA	ER40	8
ER25SEAL6AA	ER25	6	ER40SEAL10AA	ER40	10
ER25SEAL7AA	ER25	7	ER40SEAL12AA	ER40	12
ER25SEAL8AA	ER25	8	ER40SEAL14AA	ER40	14
ER25SEAL9AA	ER25	9	ER40SEAL16AA	ER40	16
ER25SEAL10AA	ER25	10	ER40SEAL18AA	ER40	18
ER25SEAL11AA	ER25	11	ER40SEAL20AA	ER40	20
ER25SEAL12AA	ER25	12	ER40SEAL22AA	ER40	22
ER25SEAL13AA	ER25	13	ER40SEAL25AA	ER40	25

ER-SEAL-AAJET

ER sealed spring collets (metric)

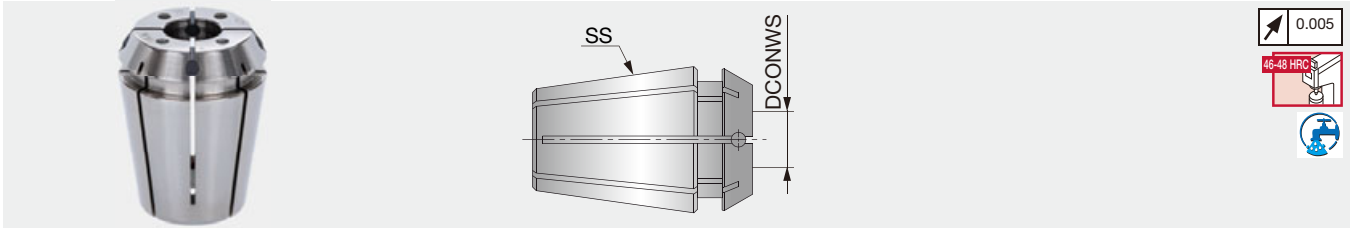

Designation	SS	DCONWS	Designation	SS	DCONWS
ER16SEAL4AAJET	ER16	4	ER25SEAL16AAJET	ER25	16
ER16SEAL5AAJET	ER16	5	ER32SEAL4AAJET	ER32	4
ER16SEAL6AAJET	ER16	6	ER32SEAL5AAJET	ER32	5
ER16SEAL7AAJET	ER16	7	ER32SEAL6AAJET	ER32	6
ER16SEAL8AAJET	ER16	8	ER32SEAL7AAJET	ER32	7
ER16SEAL9AAJET	ER16	9	ER32SEAL8AAJET	ER32	8
ER16SEAL10AAJET	ER16	10	ER32SEAL9AAJET	ER32	9
ER20SEAL4AAJET	ER20	4	ER32SEAL10AAJET	ER32	10
ER20SEAL5AAJET	ER20	5	ER32SEAL11AAJET	ER32	11
ER20SEAL6AAJET	ER20	6	ER32SEAL12AAJET	ER32	12
ER20SEAL7AAJET	ER20	7	ER32SEAL13AAJET	ER32	13
ER20SEAL8AAJET	ER20	8	ER32SEAL14AAJET	ER32	14
ER20SEAL9AAJET	ER20	9	ER32SEAL15AAJET	ER32	15
ER20SEAL10AAJET	ER20	10	ER32SEAL16AAJET	ER32	16
ER20SEAL11AAJET	ER20	11	ER32SEAL17AAJET	ER32	17
ER20SEAL12AAJET	ER20	12	ER32SEAL18AAJET	ER32	18
ER25SEAL4AAJET	ER25	4	ER32SEAL19AAJET	ER32	19
ER25SEAL5AAJET	ER25	5	ER32SEAL20AAJET	ER32	20
ER25SEAL6AAJET	ER25	6	ER40SEAL6AAJET	ER40	6
ER25SEAL7AAJET	ER25	7	ER40SEAL8AAJET	ER40	8
ER25SEAL8AAJET	ER25	8	ER40SEAL10AAJET	ER40	10
ER25SEAL9AAJET	ER25	9	ER40SEAL12AAJET	ER40	12
ER25SEAL10AAJET	ER25	10	ER40SEAL14AAJET	ER40	14
ER25SEAL11AAJET	ER25	11	ER40SEAL16AAJET	ER40	16
ER25SEAL12AAJET	ER25	12	ER40SEAL18AAJET	ER40	18
ER25SEAL13AAJET	ER25	13	ER40SEAL20AAJET	ER40	20
ER25SEAL14AAJET	ER25	14	ER40SEAL22AAJET	ER40	22
ER25SEAL15AAJET	ER25	15	ER40SEAL25AAJET	ER40	25

Grade

Insert

Ext. Toolholder

Int. Toolholder

Threading

Grooving

Miniature tool

Milling cutter

Endmill

Drilling tool

Tooling System

User's Guide

Index

SET-ER-SPR

Set of ER spring collets (Metric, DIN6499)

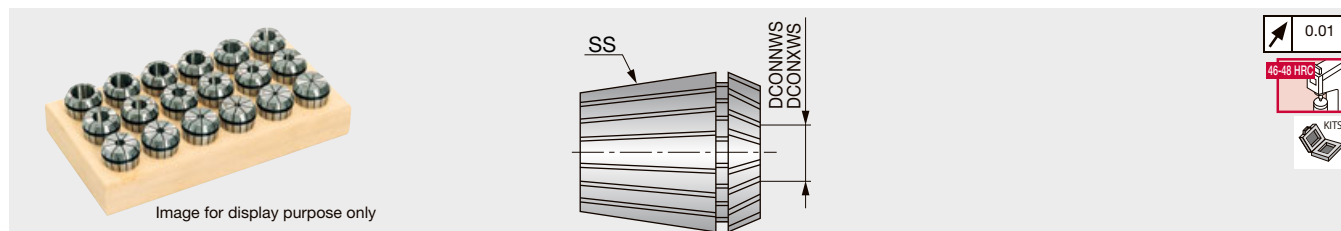

Designation	SS	Qty	DCONNWS	DCONXWS
SETER11SPR13	ER11	13	0.5	7
SETER16SPR10	ER16	10	0.5	10
SETER20SPR12	ER20	12	1	13
SETER25SPR15	ER25	15	1	16
SETER32SPR18	ER32	18	2	20
SETER40SPR23	ER40	23	3	26
SETER50SPR12	ER50	12	10	34

(Unit: mm)

SET-ER-SPR-AA

Set of ER spring AA collets (Metric, DIN6499)

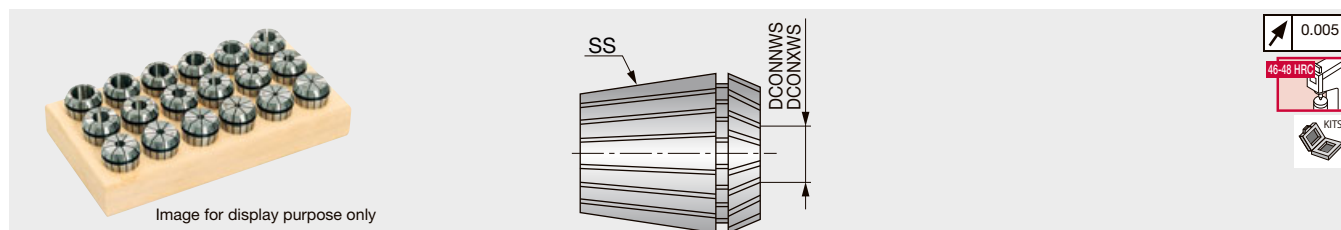

Designation	SS	Qty	DCONNWS	DCONXWS
SETER11SPR13AA	ER11	13	0.5	7
SETER16SPR10AA	ER16	10	0.5	10
SETER20SPR12AA	ER20	12	1	13
SETER25SPR15AA	ER25	15	1	16
SETER32SPR18AA	ER32	18	2	20
SETER40SPR23AA	ER40	23	3	26

(Unit: mm)

SET-ER-SPR-EM

Set of ER spring collets, for endmills (Metric, DIN6499)

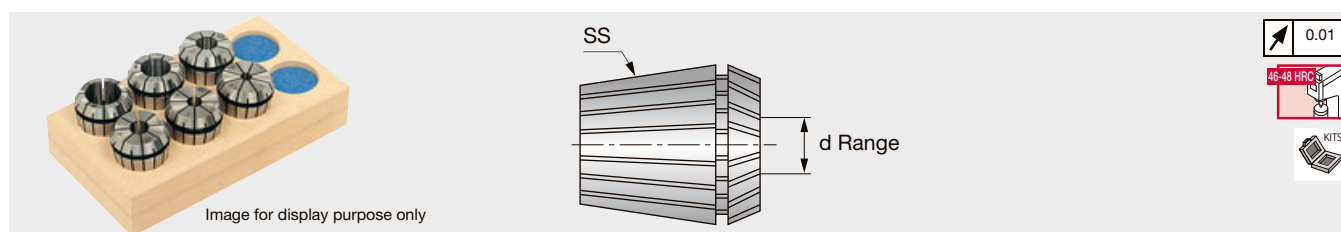

Designation	SS	Qty	Range
SETER11SPR7EM	ER11	7	1, 2, 3, 4, 5, 6, 7
SETER16SPR8EM	ER11	8	3, 4, 5, 6, 7, 8, 9, 10
SETER20SPR5EM	ER11	5	4, 6, 8, 10, 12
SETER25SPR6EM	ER11	6	4, 6, 8, 10, 12, 16
SETER32SPR6EM	ER11	6	6, 8, 10, 12, 16, 20
SETER40SPR7EM	ER11	7	6, 8, 10, 12, 16, 20, 25

(Unit: mm)

Contains popular endmill sizes only.

SETER-SEAL-AA

SET ER sealed spring collets

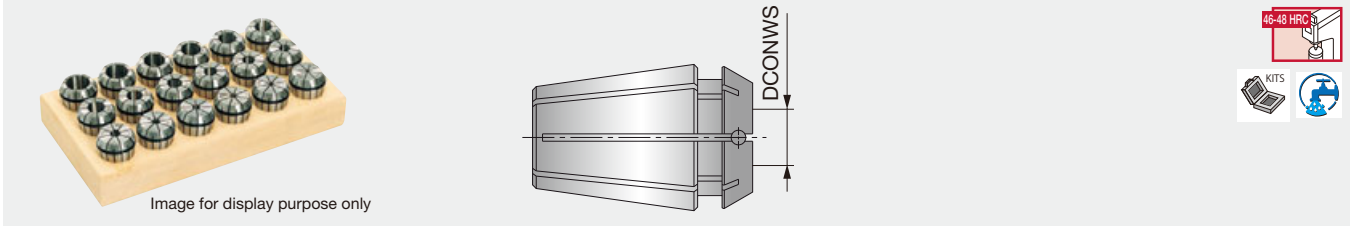

Designation	Qty	DCONNWS	DCONXWS
SETER16SEAL7AA	7	4	10
SETER20SEAL9AA	9	4	12
SETER25SEAL13AA	13	4	16
SETER32SEAL17AA	17	4	20
SETER40SEAL10AA	10	6	25
SETER16SEAL5AAINCH*	5	1/8*	3/8*
SETER20SEAL7AAINCH*	7	1/8*	1/2*
SETER25SEAL9AAINCH*	9	1/8*	5/8*
SETER32SEAL11AAINCH*	11	1/8*	3/4*
SETER40SEAL6AAINCH*	6	1/4*	1*

*inch

SETER-SEAL-AAJET

SET ER sealed spring collets

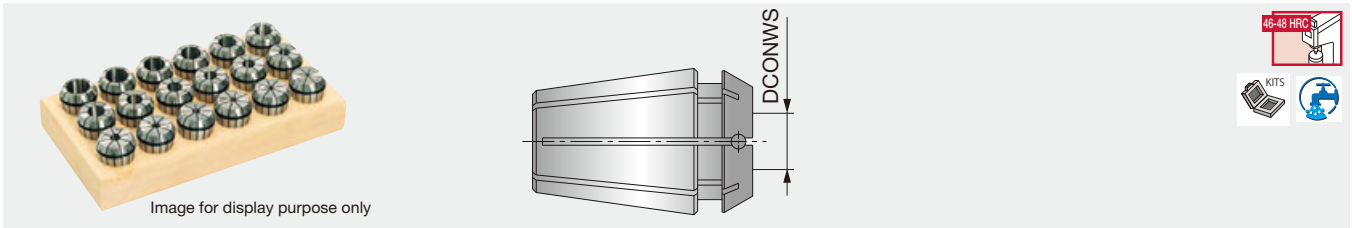

Designation	Qty	DCONNWS	DCONXWS
SETER16SEAL7AAJET	7	4	10
SETER20SEAL9AAJET	9	4	12
SETER25SEAL13AAJET	13	4	16
SETER32SEAL17AAJET	17	4	20
SETER40SEAL10AAJET	10	6	25
SETER16S5AAJETINCH*	5	1/8*	3/8*
SETER20S7AAJETINCH*	7	1/8*	1/2*
SETER25S9AAJETINCH*	9	1/8*	5/8*
SETER32S11AAJETINCH*	11	1/8*	3/4*
SETER40S6AAJETINCH*	6	1/4*	1*

*inch

Grade

Insert

Ext. Toolholder

Int. Toolholder

Threading

Grooving

Miniature tool

Milling cutter

Endmill

Drilling tool

Tooling System

User's Guide

Index

KIT R-8-ER

Kit for ER collet chuck and spring collets (R-8 Bridgeport)



Designation	Collet size	Qty	Range
KITR-810ER16	ER16	10	0.5-10
KITR-818ER32	ER32	18	2-20

Each kit has one collet chuck, a full set of ER collets, and a wrench.

KIT DIN2080-ER

Kit for ER collet chuck and spring collets (DIN2080)



Designation	Collet size	Qty	Range
KITDIN20803018ER32	ER32	18	2-20
KITDIN20804018ER32	ER32	18	2-20
KITDIN20804023ER40	ER40	23	3-26
KITDIN20805023ER40	ER40	23	3-26

Each kit has one collet chuck, a full set of ER collets, and a wrench.

KIT MT-ER

Kit for ER collet chuck and spring collets (Morse taper)



Designation	Collet size	Qty	Range
KITMT318ER32	ER32	18	2-20
KITMT423ER40	ER40	23	3-26

Each kit has one collet chuck, a full set of ER collets, and a wrench.

KIT ST-ER-Mini

Kit for ER Mini collet chuck and spring collets (cylindrical shank)



Designation	Collet size	Qty	Range
KITST12X807ER11M	ER11	7	0.5-7
KITST12X8010ER16M	ER16	10	0.5-10
KITST16X507ER11MF	ER11	7	0.5-7
KITST16X1007ER11M	ER11	7	0.5-7
KITST16X1507ER11M	ER11	7	0.5-7
KITST20X10010ER16M	ER16	10	0.5-10
KITST20X15010ER16M	ER16	10	0.5-10
KITST20X10012ER20M	ER20	12	1-12
KITST20X15012ER20M	ER20	12	1-12

• Each kit contains one collet chuck, a full set of ER collets and a Wrench. • F indicates a flat on the shank.

KIT ST-ER

Kit for ER collet chuck and spring collets (cylindrical shank)



Designation	Collet size	Qty	Range
KITST16X507ER11F	ER11	7	0.5-7
KITST20X1007ER11	ER11	7	0.5-7
KITST20X1507ER11	ER11	7	0.5-7
KITST20X5010ER16F	ER16	10	0.5-10
KITST20X10010ER16	ER16	10	0.5-10
KITST20X15010ER16	ER16	10	0.5-10
KITST20X5012ER20F	ER20	12	1-12
KITST25X10012ER20	ER20	12	1-12

• Each kit contains one collet chuck, a full set of ER collets and a Wrench. • F indicates a flat on the shank.

Grade

Insert

Ext. Toolholder

Int. Toolholder

Threading

Grooving

Miniature tool

Milling cutter

Endmill

Drilling tool

Tooling System

User's Guide

Index

A
B
C
D
E
F
G
H
I
J
K
L
M

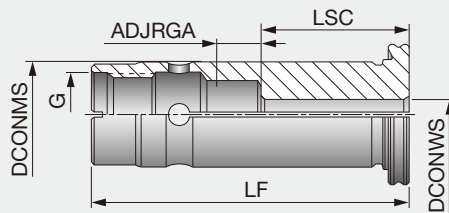

Designation	DCONWS	DCONMS	LF	LSC	ADJRGA	G
SC20SPR6	6	20	60	28	7	M16
SC20SPR8	8	20	60	28	7	M16
SC20SPR10	10	20	60	35	13	M16
SC20SPR12	12	20	60	40	8	M16
SC20SPR14	14	20	60	40	8	M16
SC20SPR15	15	20	60	40	8	M16
SC20SPR16	16	20	60	39	9	M16
SC32SPR6	6	32	72	28	17	M24X1.5
SC32SPR8	8	32	72	28	17	M24X1.5
SC32SPR10	10	32	72	35	13	M24X1.5
SC32SPR12	12	32	72	40	5	M24X1.5
SC32SPR14	14	32	72	40	5	M24X1.5
SC32SPR15	15	32	72	40	19.5	M24X1.5
SC32SPR16	16	32	72	44	17.5	M24X1.5
SC32SPR18	18	32	72	44	17.5	M24X1.5
SC32SPR19	19	32	72	44	17.5	M24X1.5
SC32SPR20	20	32	72	46	15.5	M24X1.5
SC32SPR24	24	32	72	45	10.5	M24X1.5
SC32SPR25	25	32	72	51	10.5	M24X1.5

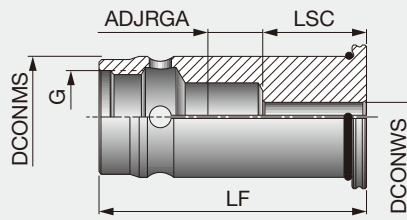

Designation	DCONWS	DCONMS	LF	LSC	ADJRGA	G
SC20SEAL6	6	20	60	28	7	M16
SC20SEAL8	8	20	60	28	7	M16
SC20SEAL10	10	20	60	35	13	M16
SC20SEAL12	12	20	60	40	8	M16
SC20SEAL14	14	20	60	40	8	M16
SC20SEAL15	15	20	60	40	8	M16
SC20SEAL16	16	20	60	39	9	M16
SC32SEAL6	6	32	72	28	17	M24X1.5
SC32SEAL8	8	32	72	28	17	M24X1.5
SC32SEAL10	10	32	72	35	13	M24X1.5
SC32SEAL12	12	32	72	40	5	M24X1.5
SC32SEAL14	14	32	72	40	5	M24X1.5
SC32SEAL15	15	32	72	40	5	M24X1.5
SC32SEAL16	16	32	72	44	17.5	M24X1.5
SC32SEAL18	18	32	72	44	17.5	M24X1.5
SC32SEAL19	19	32	72	44	17.5	M24X1.5
SC32SEAL20	20	32	72	46	15.5	M24X1.5
SC32SEAL24	24	32	72	46	15.5	M24X1.5
SC32SEAL25	25	32	72	51	10.5	M24X1.5

PRESET SC-CAP

Preset screw housing for SC-SPR collets

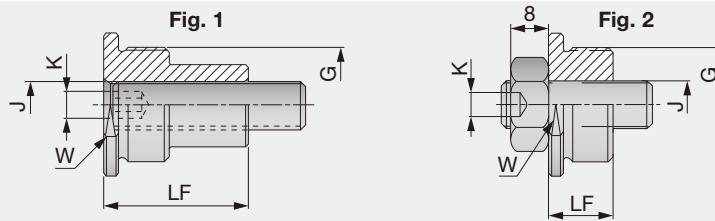

Designation	LF	W	J	G	Fig.	Range	Key size K	Collet size
PRESETSCCAP8X1.25L	28	16	M8X25	M16	1	6-8	4	SC20
PRESETSCCAP8X1.25	15	16	M8X25	M16	2	10-16	4	SC20
PRESETSCCAP10X1.5L	30	27	M10X30	M24X1.5	1	6-14	5	SC32
PRESETSCCAP10X1.5	13.5	27	M10X30	M24X1.5	2	16-25	5	SC32



TUNGHYDRO

KIT BT-HYDRO

Kit for hydraulic chucks (MAS-BT Form A/B)



Designation	BT size	DCONWS	Qty	Range
KITBT40HYDRO20X73	40	20	5	8,10,12,14,16
KITBT40HYDRO32X110	40	32	7	6,8,10,12,16,20,25

Each kit has one HYDROFIT chuck, a set of SC...HYDRO sealed reducers and a clamping wrench.

KIT DIN69871-HYDRO

Kit for hydraulic chucks (DIN69871)



Designation	SK size	DCONWS	Qty	Range
KITDIN6987140HYDRO20X65	40	20	5	8,10,12,14,16
KITDIN6987140HYDRO32X117	40	32	7	6,8,10,12,16,20,25

Each kit has one HYDROFIT chuck, a set of SC...HYDRO sealed reducers and a clamping wrench.

KIT HSK A-HYDRO

Kit for hydraulic chucks (HSK)



Designation	HSK size	DCONWS	Qty	Range
KITHSKA63HYDRO20X100	63	20	5	8,10,12,14,16
KITHSKA63HYDRO32X125	63	32	7	6,8,10,12,16,20,25

Each kit has one HYDROFIT chuck, a set of SC...HYDRO sealed reducers and a clamping wrench.

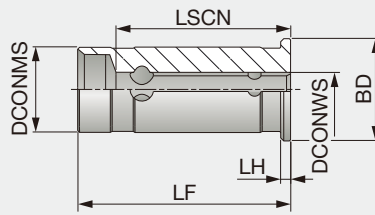

Designation	DCONMS	DCONWS	LSCN	LF	BD	LH
SC12SHYDRO3	12	3	19	46.5	16	2
SC12SHYDRO4	12	4	24	46.5	16	2
SC12SHYDRO5	12	5	28	46.5	16	2
SC12SHYDRO6	12	6	33	46.5	16	2
SC12SHYDRO8	12	8	39	46.5	16	2
SC20SHYDRO3	20	3	20	53	24	2
SC20SHYDRO4	20	4	25	53	24	2
SC20SHYDRO5	20	5	27	53	24	2
SC20SHYDRO6	20	6	34	53	24	2
SC20SHYDRO8	20	8	39	53	24	2
SC20SHYDRO10	20	10	40	53	24	2
SC20SHYDRO12	20	12	41	53	24	2
SC20SHYDRO14	20	14	44	53	24	2
SC20SHYDRO16	20	16	44	53	24	2
SC25SHYDRO6	25	6	37	60	30	4
SC25SHYDRO8	25	8	37	60	30	4
SC25SHYDRO10	25	10	40	60	30	4
SC25SHYDRO12	25	12	44	60	30	4
SC25SHYDRO14	25	14	46	60	30	4
SC25SHYDRO16	25	16	48	60	30	4
SC25SHYDRO18	25	18	50	60	30	4
SC25SHYDRO20	25	20	50	60	30	4
SC32SHYDRO6	32	6	33	66	40	4
SC32SHYDRO8	32	8	38	66	40	4
SC32SHYDRO10	32	10	39	66	40	4
SC32SHYDRO12	32	12	42	66	40	4
SC32SHYDRO14	32	14	44	66	40	4
SC32SHYDRO16	32	16	44	66	40	4
SC32SHYDRO18	32	18	44	66	40	4
SC32SHYDRO20	32	20	49	66	40	4
SC32SHYDRO25	32	25	66	66	40	4

TUNGHYDRO

PRESET SCREW HYDRO

Preset screw for hydraulic collet chucks

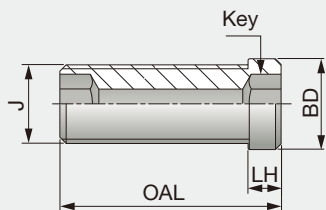

Designation	BD	J	OAL	LH	Wrench
PRESETSCREWHYDROM5	5	M5	14	1	2.5
PRESETSCREWHYDROM6	6	M6	14	1.5	3
PRESETSCREWHYDROM8	8	M8X1	14	2	4
PRESETSCREWHYDROM10	10	M10X1	17	2	5
PRESETSCREWHYDROM16	14	M16X1	20	2	8

TEST BAR HYDRO

Torque test bar for hydraulic chucks

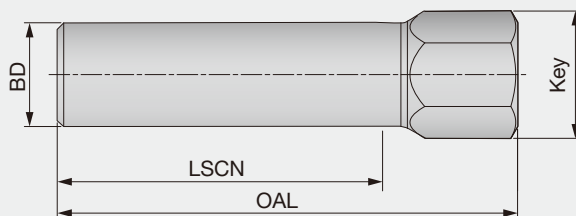

Designation	BD	OAL	Wrench	LSCN ⁽¹⁾	Torque*
TESTBARHYDRO6	6	53	10	27	15
TESTBARHYDRO8	8	53	10	27	25
TESTBARHYDRO10	10	56	10	32	50
TESTBARHYDRO12	12	62	10	37	110
TESTBARHYDRO14	14	62	10	37	120
TESTBARHYDRO16	16	71	17	37	180
TESTBARHYDRO18	18	71	17	42	230
TESTBARHYDRO20	20	71	17	42	250
TESTBARHYDRO25	25	79	17	48	310
TESTBARHYDRO32	32	87	17	52	450

(1) Minimum holding length, *Torque: Recommended torque (N-m) for clamping.

TUNGMAX

KIT SK-TUNGMAX

Kit for power chuck holder and spring collets (DIN69871)



Designation	SK size	DCONMS	Qty	Range
KITSK40MAXIN20X956	40	20	6	6,8,10,12,14,16
KITSK40MAXIN32X1067	40	32	7	6,8,10,12,16,20,25
KITSK50MAXIN32X1007	50	32	7	6,8,10,12,16,20,25

Each kit has one power chuck, a set of SC-SPR collets, extraction hook, and wrench.

Set of SC collets



Designation	Collet size	Qty	Range
SETSC20SPR6	20	6	6,8,10,12,14,16
SETSC32SPR9	32	9	6,8,10,12,14,16,18,20,25

SET SC-SEAL

Set of SC collets with coolant hole



Designation	Collet size	Qty	Range
SETSC20SEAL6	20	6	6,8,10,12,14,16
SETSC32SEAL9	32	9	6,8,10,12,14,16,18,20,25

Grade

A

Insert

B

Ext. Toolholder

C

Int. Toolholder

D

Threading

E

Grooving

F

Miniature tool

G

Milling cutter

H

Endmill

I

Drilling tool

J

Tooling System

K

User's Guide

L

Index

M

Threaded connector for ER collet chucks

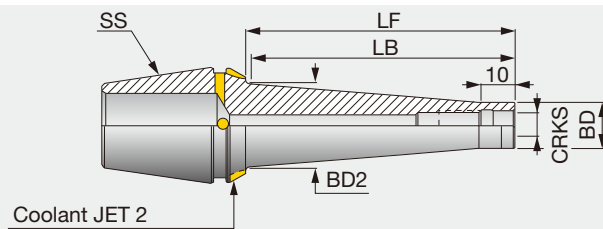

Designation	CRKS	SS	BD	BD2	LF	LB
ER32ODPM8X25	M8	ER32	13.1	15	25	22
ER32ODPM8X50	M8	ER32	13.1	23	50	49
ER32ODPM8X75	M8	ER32	13.1	23	75	74
ER32ODPM10X25	M10	ER32	18	20	25	23
ER32ODPM10X50	M10	ER32	18	24	50	49
ER32ODPM12X25	M12	ER32	21	24	25	24
ER32ODPM12X50	M12	ER32	21	24	50	49

DIN
69871

HSK

BT
MASDIN
2080

Others

Side
lockCollet
chuckFace
millMilling
chuckHydro
chuckShrinking
chuck

Others

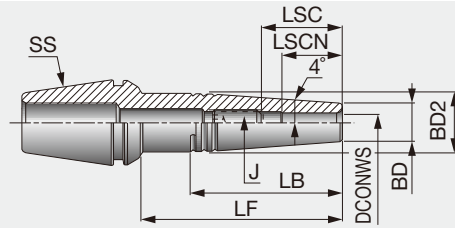

Designation	SS	DCONWS	BD	BD2	LF	LB	LSCN	LSC	J	Wrench
ER11SRK3X10 ⁽¹⁾	ER11	3	7.6	8.5	10	-	9.5	-	-	-
ER11SRK3X25 ⁽¹⁾	ER11	3	7.6	8.5	25	-	11.5	-	-	-
ER11SRK4X10 ⁽¹⁾	ER11	4	7.6	8.5	10	-	9.5	-	-	-
ER11SRK4X25 ⁽¹⁾	ER11	4	7.6	8.5	25	-	11.5	-	-	-
ER20SRK3X35	ER20	3	10	13.5	35	24	10	16	M6	3
ER20SRK3X60	ER20	3	10	13.5	60	24	10	16	M6	3
ER20SRK4X35	ER20	4	10	13.5	35	24	12	18	M6	3
ER20SRK4X60	ER20	4	10	13.5	60	24	12	18	M6	3
ER20SRK5X35	ER20	5	10	13.5	35	24	15	21	M6	3
ER20SRK5X60	ER20	5	10	13.5	60	24	15	21	M6	3
ER20SRK6X35	ER20	6	11	14.7	35	25	18	24	M8	4
ER20SRK6X60	ER20	6	11	15.2	60	29	18	24	M8	4
ER25SRK3X35	ER25	3	10	13.5	35	24	10	16	M6	3
ER25SRK3X60	ER25	3	10	16.3	60	44	10	16	M6	3
ER25SRK4X35	ER25	4	10	13.5	35	24	12	18	M6	3
ER25SRK4X60	ER25	4	10	16.3	60	44	12	18	M6	3
ER25SRK5X35	ER25	5	10	13.5	35	24	15	21	M6	3
ER25SRK5X60	ER25	5	10	16.3	60	44	15	21	M6	3
ER25SRK6X35	ER25	6	11	14.7	35	26	18	24	M8	4
ER25SRK6X60	ER25	6	11	17.3	60	44	18	24	M8	4
ER25SRK8X35	ER25	8	14	17.8	35	26	25	30	M10	5
ER25SRK8X60	ER25	8	14	19.7	60	39	25	31	M10	5
ER32SRK3X35	ER32	3	10	13.2	35	22	10	16	M6	3
ER32SRK3X60	ER32	3	10	16.3	60	44	10	16	M6	3
ER32SRK3X85	ER32	3	10	19.8	85	70	10	16	M6	3
ER32SRK4X35	ER32	4	10	13.4	35	23	12	18	M6	3
ER32SRK4X60	ER32	4	10	16.3	60	44	12	18	M6	3
ER32SRK4X85	ER32	4	10	19.8	85	70	12	18	M6	3
ER32SRK5X35	ER32	5	10	13.5	35	24	15	21	M6	3
ER32SRK5X60	ER32	5	10	16.3	60	44	15	21	M6	3
ER32SRK5X85	ER32	5	10	19.8	85	70	15	21	M6	3
ER32SRK6X35	ER32	6	11	14.7	35	25	18	24	M8	4
ER32SRK6X60	ER32	6	11	17.3	60	45	18	24	M8	4
ER32SRK6X85	ER32	6	11	20.8	85	69	18	26	M8	4
ER32SRK8X35	ER32	8	14	18.8	35	33	25	31	M10	5
ER32SRK8X60	ER32	8	14	20.4	60	45	25	31	M10	5
ER32SRK8X85	ER32	8	14	23.2	85	65	25	31	M10	5
ER32SRK10X35	ER32	10	16	20.8	35	34	30	35	M12	6
ER32SRK10X60	ER32	10	16	22.4	60	44	30	36	M12	6
ER32SRK10X85	ER32	10	16	23	85	49	30	36	M12	6
ER32SRK12X35	ER32	12	20	24	35	28	32	-	-	-
ER32SRK12X60	ER32	12	20	24	60	28	32	38	M14	6
ER32SRK12X85	ER32	12	20	24	85	28	32	38	M14	6

(1) Use SpinJet spindle only.

TungShrink, ER collet type, for external coolant supply

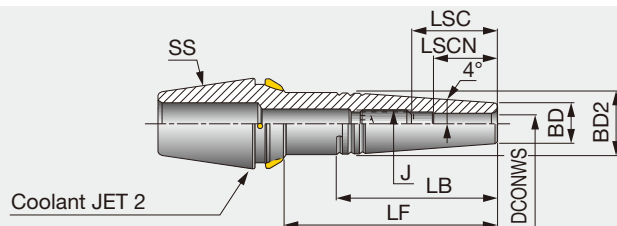

Designation	SS	DCONWS	BD	BD2	LF	LB	LSCN	LSC	J	Wrench
ER20SRK3X35JET2	ER20	3	10	13.5	35	24.5	10	16	M6	3
ER20SRK5X35JET2	ER20	5	10	13.5	35	24.5	15	21	M6	3
ER20SRK6X35JET2	ER20	6	11	14.7	35	25.5	18	24	M8	4
ER25SRK3X35JET2	ER25	3	10	13.5	35	24.5	10	16	M6	3
ER25SRK3X60JET2	ER25	3	10	16.3	60	44.5	10	16	M6	3
ER25SRK4X35JET2	ER25	4	10	13.5	35	24.5	12	18	M6	3
ER25SRK4X60JET2	ER25	4	10	16.3	60	44.5	12	18	M6	3
ER25SRK5X35JET2	ER25	5	10	13.5	35	24.5	15	21	M6	3
ER25SRK5X60JET2	ER25	5	10	16.3	60	44.5	15	21	M6	3
ER25SRK6X35JET2	ER25	6	11	14.7	35	26	18	24	M8	4
ER25SRK6X60JET2	ER25	6	11	17.3	60	44.5	18	24	M8	4
ER25SRK8X35JET2	ER25	8	14	17.8	35	26.5	25	30	M10	5
ER25SRK8X60JET2	ER25	8	14	19.7	60	39.5	25	31	M10	5
ER32SRK3X35JET2	ER32	3	10	13.2	35	22.5	10	16	M6	3
ER32SRK3X60JET2	ER32	3	10	16.3	60	44.5	10	16	M6	3
ER32SRK3X85JET2	ER32	3	10	19.8	85	70	10	16	M6	3
ER32SRK4X35JET2	ER32	4	10	13.4	35	23.5	12	18	M6	3
ER32SRK4X60JET2	ER32	4	10	16.3	60	44.5	12	18	M6	3
ER32SRK4X85JET2	ER32	4	10	19.8	85	70	12	18	M6	3
ER32SRK5X35JET2	ER32	5	10	13.5	35	24.5	15	21	M6	3
ER32SRK5X60JET2	ER32	5	10	16.3	60	44.5	15	21	M6	3
ER32SRK5X85JET2	ER32	5	10	19.8	85	70	15	21	M6	3
ER32SRK6X35JET2	ER32	6	11	14.7	35	25.5	18	24	M8	4
ER32SRK6X60JET2	ER32	6	11	17.3	60	45	18	24	M8	4
ER32SRK6X85JET2	ER32	6	11	20.8	85	69.5	18	26	M8	4
ER32SRK8X35JET2	ER32	8	14	18.8	35	33	25	31	M10	5
ER32SRK8X60JET2	ER32	8	14	20.4	60	45	25	31	M10	5
ER32SRK8X85JET2	ER32	8	14	23.2	85	65	25	31	M10	5
ER32SRK10X35JET2	ER32	10	16	20.8	35	34	30	35	M12	6
ER32SRK10X60JET2	ER32	10	16	22.4	60	44.5	30	36	M12	6
ER32SRK10X85JET2	ER32	10	16	23	85	49.5	30	36	M12	6
ER32SRK12X35JET2	ER32	12	20	24	35	28	32	-	-	-
ER32SRK12X60JET2	ER32	12	20	24	60	28	32	38	M14	6
ER32SRK12X85JET2	ER32	12	20	24	85	28	32	38	M14	6

Side lock

Collet chuck

Face mill

Milling chuck

Hydro chuck

Shrinking chuck

Others

SHRINKIN Induction heating unit for shrink tool chucking



Designation

IND SHRINK IN UNIT EUR

Main working post
#50, HSK 100

Tool adapter post

Cooling house

Tray for
cutting tools

Control panel

Drawer for
adapter

Coil rings

Induction
main unit

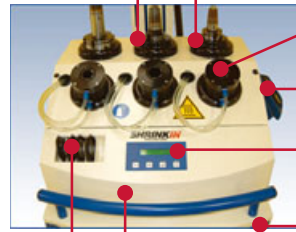

Machine

3-380-500V 50/60HZ

IND SHRINK START UNIT

SHRINKIN Induction heating unit for shrink tool chucking



Designation

IND SHRINK START UNIT EUR

Machine

3-380-500V 50/60HZ

SET ER-SRK

Set of ER collets with thermal shrink chucks



Designation

SETER32SRKL6EUR

Collet size

32

Qty

6

Range

4,5,6,8,10,12

SETER32SRKM6EUR

32

6

4,5,6,8,10,12

SETER32SRKS6EUR

32

6

4,5,6,8,10,12

TungShrink, quick change type

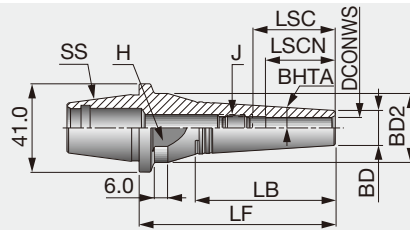

Designation	SS	DCONWS	BD	BD2	LF	LB	J	Wrench	BHTA	H	LSCN	LSC
ER32SRF3X50	32 SRF	3	10	32	50	31	M6	3	4°	27	10	16
ER32SRF3X85	32 SRF	3	10	32	85	60.5	M6	3	4°	27	10	16
ER32SRF4X50	32 SRF	4	10	32	50	31	M6	3	4°	27	12	18
ER32SRF4X85	32 SRF	4	10	32	85	60.5	M6	3	4°	27	12	18
ER32SRF5X50	32 SRF	5	10	32	50	31	M6	3	4°	27	15	21
ER32SRF5X85	32 SRF	5	10	32	85	60.5	M6	3	4°	27	15	21
ER32SRF6X50	32 SRF	6	11	32	50	31	M8	4	4°	27	18	24
ER32SRF6X85	32 SRF	6	11	32	85	60.5	M8	4	4°	27	18	24
ER32SRF8X50	32 SRF	8	14	32	50	33	M10	5	4°	27	25	31
ER32SRF8X85	32 SRF	8	14	32	85	60.5	M10	5	4°	27	25	31
ER32SRF10X50	32 SRF	10	16	32	50	35	M12	6	4°	27	30	35
ER32SRF10X85	32 SRF	10	16	32	85	60.5	M12	6	4°	27	30	36
ER32SRF12X50	32 SRF	12	20	32	50	35	M14	6	4°	27	32	37
ER32SRF12X85	32 SRF	12	20	32	85	50	M14	6	4°	27	32	38

Tightening torque: 235 N-m.

ER-SRF JET2

TungClick, quick change type, thermal shrinking holder

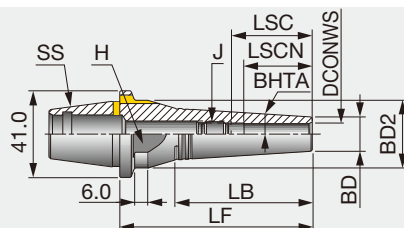

Designation	SS	DCONWS	BD	BD2	LF	LB	J	Wrench	BHTA	H	LSCN	LSC
ER32SRF3X50JET2	32 SRF	3	10	32	50	31	M6	3	4°	27	10	16
ER32SRF4X50JET2	32 SRF	4	10	32	50	31	M6	3	4°	27	12	18
ER32SRF6X50JET2	32 SRF	6	11	32	50	31	M8	4	4°	27	18	24
ER32SRF6X85JET2	32 SRF	6	11	32	85	60	M8	4	4°	27	18	24
ER32SRF8X50JET2	32 SRF	8	14	32	50	33	M10	5	4°	27	25	31
ER32SRF12X50JET2	32 SRF	12	20	32	50	35	M14	6	4°	27	32	37
ER32SRF12X85JET2	32 SRF	12	20	32	85	50	M14	6	4°	27	32	38

Tightening torque: 235 N-m.

Tapping attachment for ER collet chuck holders (ISO)

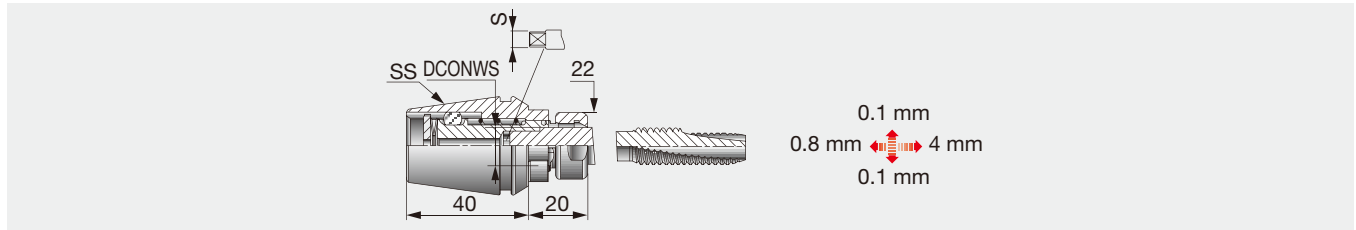

Designation	SS	DCONWS	S	Tap min	Tap max	H
GTINER32ISO2.24X1.80	ER32	2.24	1.8	M3	M3	20
GTINER32ISO2.50X2.00	ER32	2.5	2	M3.5	M3.5	20
GTINER32ISO2.80X2.24	ER32	2.8	2.24	M2.2	M2.5	20
GTINER32ISO3.15X2.50	ER32	3.15	2.5	M3	M4	20
GTINER32ISO3.55X2.80	ER32	3.55	2.8	M3.5	M4.5	20
GTINER32ISO4.00X3.15	ER32	4	3.15	M4	M5	20
GTINER32ISO4.50X3.55	ER32	4.5	3.55	M6	M6	20
GTINER32ISO5.00X4.00	ER32	5	4	M5	M5	20
GTINER32ISO5.60X4.50	ER32	5.6	4.5	UNC#12-24	UNC#12-24	20
GTINER32ISO6.30X5.00	ER32	6.3	5	M6	M8	20
GTINER32ISO7.10X5.60	ER32	7.1	5.6	UNC#-3/8-16	UNC#-3/8-16	20
GTINER32ISO8.00X6.30	ER32	8	6.3	M8	M10	20
GTINER32ISO9.00X7.10	ER32	9	7.1	M12	M12	20
GTINER32ISO10.00X8.00	ER32	10	8	M10	M10	20
GTINER32ISO11.20X9.00	ER32	11.2	9	M14	M14	20
GTINER32ISO12.50X10.00	ER32	12.5	10	M16	M16	20

No coolant should be induced through the tapping collet, as it will cause malfunctioning of the mechanism.

GTIN ER-DIN

Tapping attachment for ER collet chuck holders (DIN)

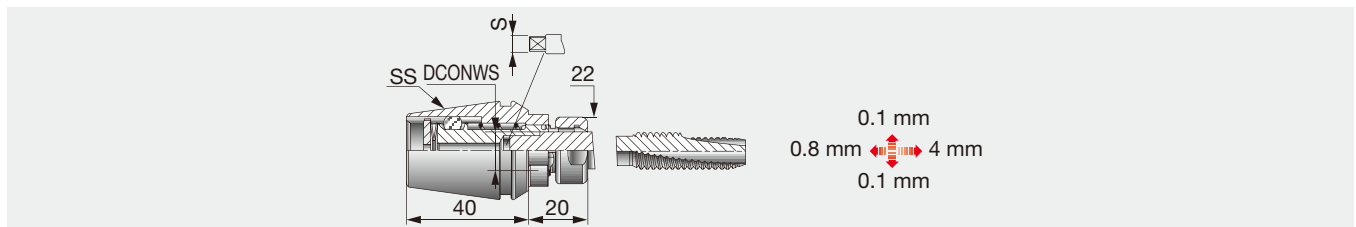

Designation	SS	DCONWS	S	Tap min	Tap max	H
GTINER32DIN2.50X2.10	ER32	2.5	2.1	M1	M1.8	20
GTINER32DIN2.80X2.10	ER32	2.8	2.1	M2	M4	20
GTINER32DIN3.50X2.70	ER32	3.5	2.7	M3	M5	20
GTINER32DIN4.00X3.00	ER32	4	3	M3	M5	20
GTINER32DIN4.50X3.40	ER32	4.5	3.4	M4	M6	20
GTINER32DIN6.00X4.90	ER32	6	4.9	M5	M8	20
GTINER32DIN7.00X5.50	ER32	7	5.5	M10	M10	20
GTINER32DIN8.00X6.20	ER32	8	6.2	M8	M8	20
GTINER32DIN9.00X7.00	ER32	9	7	M12	M12	20
GTINER32DIN10.00X8.00	ER32	10	8	M10	M10	20
GTINER32DIN11.00X9.00	ER32	11	9	M14	M14	20
GTINER32DIN12.00X9.00	ER32	12	9	M16	M16	20

No coolant should be induced through the tapping collet, as it will cause malfunctioning of the mechanism.

Tapping attachment for ER collet chuck holders (JIS)

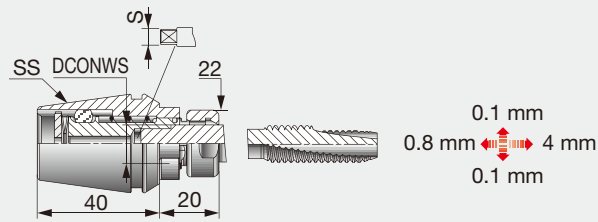

Designation	SS	DCONWS	S	Tap min	Tap max	H
GTINER32JIS3.00X2.50	ER32	3	2.5	M1	M2.6	20
GTINER32JIS4.00X3.20	ER32	4	3.2	M3	M3.5	20
GTINER32JIS5.00X4.00	ER32	5	4	M4	M4	20
GTINER32JIS6.00X4.50	ER32	6	4.5	M6	M6	20
GTINER32JIS6.20X5.00	ER32	6.2	5	M8	M8	20
GTINER32JIS7.00X5.50	ER32	7	5.5	M10	M10	20
GTINER32JIS8.50X6.50	ER32	8.5	6.5	M12	M12	20
GTINER32JIS10.50X8.00	ER32	10.5	8	M14	M14	20
GTINER32JIS12.50X10.00	ER32	12.5	10	M16	M16	20

No coolant should be induced through the tapping collet, as it will cause malfunctioning of the mechanism

PS BT-JIS/MAZAK

Pull stud with JIS/ANSI retention knob (BT), for MAZAK machines

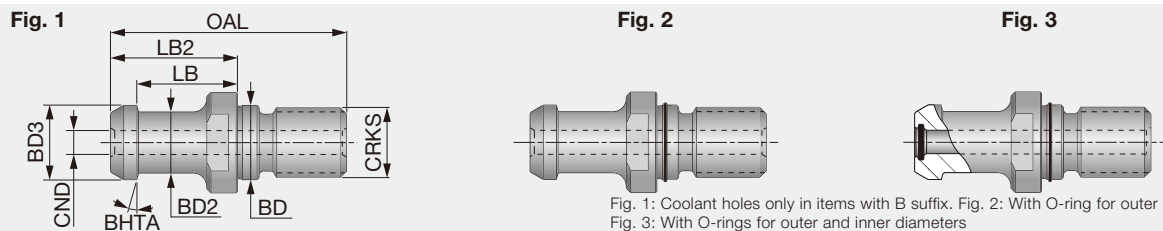

Fig. 1: Coolant holes only in items with B suffix. Fig. 2: With O-ring for outer diameter. Fig. 3: With O-rings for outer and inner diameters

Designation	BT size	CRKS	BD3	BD2	BD	CND	LB	OAL	LB2	BHTA	Fig.
PSBT3015M12JISB	30	M12	12	8	12.5	4	18.4	43	23.4	15°	1
PSBT4015M16JISB	40	M16	19	14	17	5.5	23	54	29	15°	1
PSBT4015M16JISOB	40	M16	19	14	17	5.5	23	54	29	15°	2
PSBT4015M16JISOBO	40	M16	19	14	17	5.5	23	54	29	15°	3
PSBT5015M24JISB	50	M24	28	21	25	8	25	74	34	15°	1
PSBT5015M24JISOB	50	M24	28	21	25	8	25	74	34	15°	2
PSBT5015M24JISOBO	50	M24	28	21	25	8	25	74	34	15°	3
PSBT4045M16MAZAKB	40	M16	18.79	12.4	17	7	14.026	44.1	19.1	45°	1
PSBT5045M24MAZAKB	50	M24	28.95	20.8	25	8	17.58	65.2	25.2	45°	1

PS BT-MAS

Pull stud with MAS retention knob (BT)

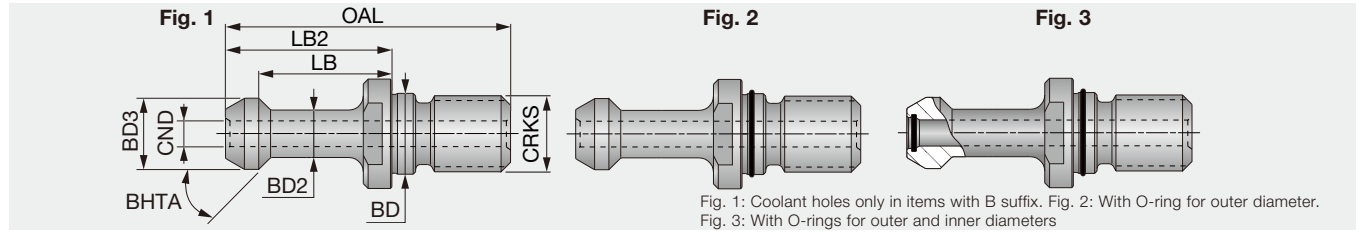

Fig. 1: Coolant holes only in items with B suffix. Fig. 2: With O-ring for outer diameter. Fig. 3: With O-rings for outer and inner diameters

Designation	BT size	CRKS	BD3	BD2	BD	CND	LB	OAL	LB2	BHTA	Fig.
PSBT3045M12MAS1	30	M12	11	7	12.5	-	18	43	23	45°	1
PSBT3045M12MAS1B	30	M12	11	7	12.5	3	18	43	23	45°	1
PSBT3060M12MAS2	30	M12	11	7	12.5	-	18	43	23	60°	1
PSBT4045M16MAS1	40	M16	15	10	17	-	28	60	35	45°	1
PSBT4045M16MAS1B	40	M16	15	10	17	5.5	28	60	35	45°	1
PSBT4060M16MAS2	40	M16	15	10	17	-	28	60	35	60°	1
PSBT4060M16MAS2B	40	M16	15	10	17	5.5	28	60	35	60°	1
PSBT4090M16MAS3	40	M16	15	10	17	-	28	60	35	90°	1
PSBT4090M16MAS3B	40	M16	15	10	17	5.5	28	60	35	90°	1
PSBT5045M24MAS1	50	M24	23	17	25	-	35	85	45	45°	1
PSBT5045M24MAS1B	50	M24	23	17	25	6	35	85	45	45°	1
PSBT5045M24MAS1OB	50	M24	23	17	25	6	35	85	45	45°	2
PSBT5045M24MAS1OBO	50	M24	23	17	25	6	35	85	45	45°	3
PSBT5060M24MAS2	50	M24	23	17	25	-	35	85	45	60°	1
PSBT5060M24MAS2B	50	M24	23	17	25	6	35	85	45	60°	1
PSBT5060M24MAS2OB	50	M24	23	17	25	6	35	85	45	60°	2
PSBT5090M24MAS3	50	M24	23	17	25	-	35	85	45	90°	1
PSBT5090M24MAS3B	50	M24	23	17	25	6	35	85	45	90°	1
PSBT5090M24MAS3OB	50	M24	23	17	25	6	35	85	45	90°	2

PS SK-DIN

Pull stud with JIS63398 retention knob (DIN69872)

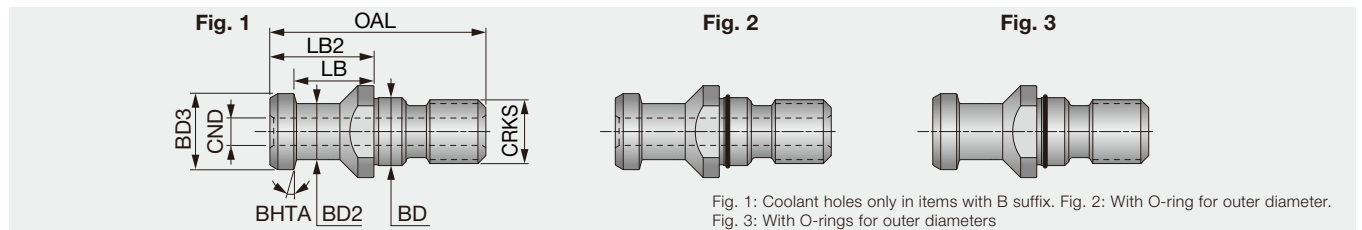
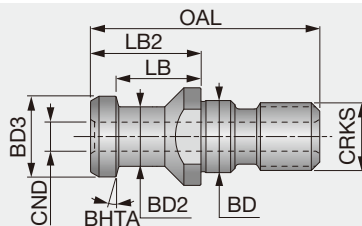

Fig. 1: Coolant holes only in items with B suffix. Fig. 2: With O-ring for outer diameter. Fig. 3: With O-rings for outer diameters

Designation	SK size	CRKS	BD3	BD2	BD	CND	LB	OAL	LB2	BHTA	Fig.
PSSK3015M12DIN	30	M12	13	9	13	-	19	44	24	15°	1
PSSK4015M16DIN	40	M16	19	14	17	-	20	54	26	15°	1
PSSK4015M16DINO	40	M16	19	14	17	-	20	54	26	15°	3
PSSK4015M16DINB	40	M16	19	14	17	7	20	54	26	15°	1
PSSK4015M16DINOBO	40	M16	19	14	17	7	20	54	26	15°	2
PSSK5015M24DIN	50	M24	28	21	25	-	25	74	34	15°	1
PSSK5015M24DINO	50	M24	28	21	25	-	25	74	34	15°	3
PSSK5015M24DINB	50	M24	28	21	25	11.5	25	74	34	15°	1

PS CAT-ISO

Pull stud with CAT-MAS G-mm Retention knob, with coolant hole



Designation	CAT size	CRKS	BD3	BD2	BD	CND	LB	OAL	LB2	BHTA
PSCAT3045M12ISOB	30	M12	13.35	9.3	13	4.75	8.1	34	11.8	45°
PSCAT4045M16ISOB	40	M16	18.95	12.9	17	7.35	11.2	44.5	16.4	45°
PSCAT5045M24ISOB	50	M24	29.1	19.6	25	8	17.9	65.5	25.55	45°

Coolant holes only in items with B suffix.

PS OTT-BT

Pull stud with OTT system retention knob (BT)

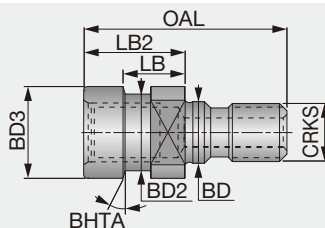

Designation	BT size	CRKS	BD3	BD2	BD	LB	OAL	LB2	BHTA
PSOTTBT40M16	40	M16	25	21.1	17	16.6	56	28	15°
PSOTTBT50M24	50	M24	39.3	32	25	13.4	65	25	15°

NUT ER-TOP

Nut for ER collet chucks (DIN6499)

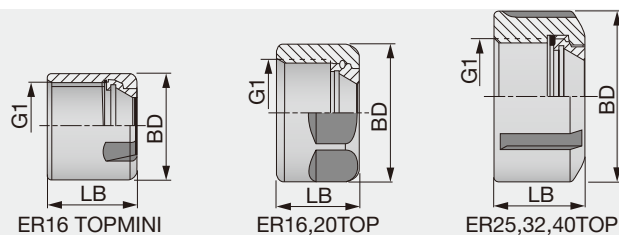

Designation	BD	LB	G1	Torque*
NUTER16TOP	28	17	M22X1.5	68.7
NUTER20TOP	34	19	M25X1.5	117.7
NUTER25TOP	42	20	M32X1.5	196.1
NUTER32TOP	50	22	M40X1.5	215.7
NUTER40TOP	63	25	M50X1.5	245.1

*Torque: Recommended torque (N-m) for clamping

NUT ER-UM/MINI

UM/Mini nut for ER collet chucks (DIN6499)

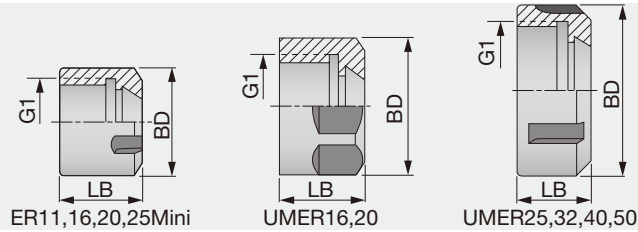

Designation	BD	LB	G1	Torque*
NUTER11GHS ⁽¹⁾	16	11.5	M13X0.75	-
NUTER11MINI	16	10.8	M13X0.75	29.4
NUTER11UM	19	11.3	M14X0.75	49
NUTER16MINI	22	18	M19X1.0	39.2
NUTER16UM	28	17	M22X1.5	68.7
NUTER20MINI	28	19	M24X1.0	78.5
NUTER20UM	34	19	M25X1.5	117.7
NUTER25MINI	35	20	M30X1.0	98
NUTER25UM	42	20	M32X1.5	196.1
NUTER32UM	50	22	M40X1.5	215.7
NUTER40UM	63	25	M50X1.5	245.1
NUTER50UM	78	35	M64X2.0	343.2

*Torque: Recommended torque (N-m) for clamping
(1) To be used only for SpinJet spindles

TUNGBALANCE NUT ER-BALANCE

Balanceable nut for ER collet chucks (DIN6499)

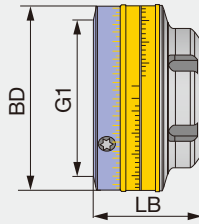

Designation	BD	LB	G1	Torque*
NUTER16TOPBIN	36	44	M22X1.5	68.7
NUTER25TOPBIN	37.5	58	M32X1.5	196.1

*Torque: Recommended torque (N-m) for clamping

TUNGSHORT NUT ER-SHORT

Nut for ER collet chucks (TungShort)

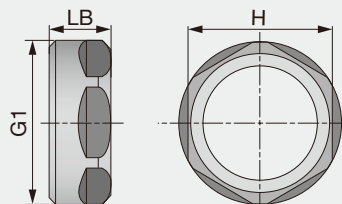

Designation	H	LB	G1	Torque*
NUTER20SHORT	22	10.7	M25X1.5	117.7
NUTER32SHORT	36	15	M40X1.5	215.7
NUTER40SHORT	46	16	M50X1.5	245.1

*Torque: Recommended torque (N-m) for clamping

WRENCH ER

Wrench for ER nut (DIN6499)

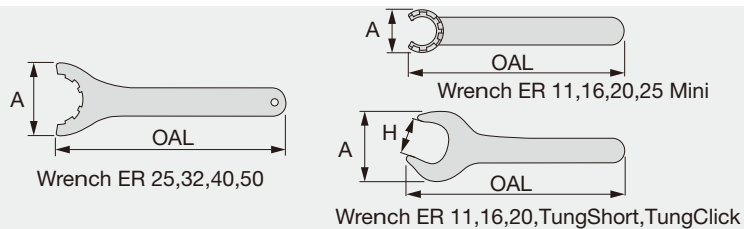

Designation	A	H	OAL
WRENCHER11SMS ⁽¹⁾	16	-	95
WRENCHER11MINI	16.8	-	95
WRENCHER11	32	17	95
WRENCHER16MINI	22.5	-	117
WRENCHER16	42.5	25	143
WRENCHER20MINI	28	-	128
WRENCHER20	53.5	30	172
WRENCHER25MINI	29	-	120
WRENCHER25	70	-	207
WRENCHER32	78	-	255
WRENCHER40	95	-	285
WRENCHER50	110	-	350
WRENCHER20SHORTRING22	48	22	260
WRENCHER32SHORT	75	36	303
WRENCHER40SHORT	94	46	378
WRENCHER32CLICKIN27	57	27	239
WRENCHER32CLICKIN32	67	32	273

(1) Use SpinJet spindle only.

TUNGMAX WRENCH

Wrench for TungMax collets

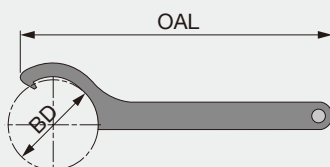

Designation	BD	OAL
WRENCHMAXIN20HOOK	52	205
WRENCHMAXIN32HOOK	68	240

SC

SC collet extracting hook

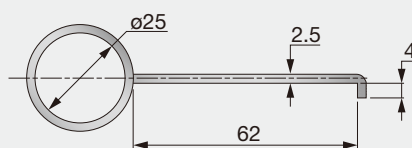

Designation
EXTRACTOR SC COLLETS

PRESET ER-JET

Preset screw for ER collet chucks

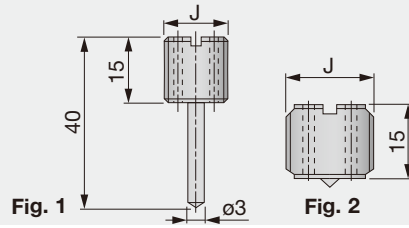

Designation	J	Fig.
PRESETER-JET8X1	M8X1.0	2
PRESETER-JET8X1.25	M8X1.25	2
PRESETER-JET10X1.5	M10X1.5	2
PRESETER-JET12X1	M12X1.0	2
PRESETER-JET12X1.75L	M12X1.75	1
PRESETER-JET12X1.75	M12X1.75	2
PRESETER-JET14X1	M14X1.0	2
PRESETER-JET16X2	M16X2	2
PRESETER-JET16X2L	M16X2	1
PRESETER-JET18X1	M18X1.0	2
PRESETER-JET18X1.5	M18X1.5	2
PRESETER-JET18X1.5L	M18X1.5	1
PRESETER-JET22X1.5	M22X1.5	2
PRESETER-JET22X1.5L	M22X1.5	1
PRESETER-JET28X1.5	M28X1.5	2

TUNGMAX

Preset Screw

Preset screw for SC-SPR

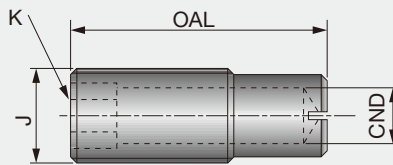

Designation	J	OAL	CND	K
PRESETMAXIN16X30	M16	30	8	8
PRESETMAXIN16X44	M16	44	8	8
PRESETMAXIN20X55	M20	55	12	12

SCREW-SEM

Lock screw for shell mill holders

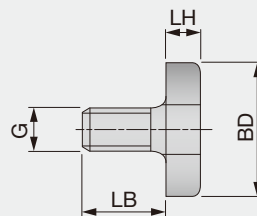

Designation	G	BD	LH	LB
M8CLAMPSCREWSEM16	M8	20	6	16
M10CLAMPSCREWSEM22	M10	28	7	18
M12CLAMPSCREWSEM27	M12	35	8	22
M16CLAMPSCREWSEM32	M16	42	9	26
M20CLAMPSCREWSEM40	M20	52	10	30
M24CLAMPSCREWSEM50	M24	63	12	36
SCREW 3/8-24 SEM 3/4"	3/8"x24 UNF-2A	22.5	10	18
SCREW 1/2-20X7/8 SEM 1"	1/2x20 UNF-2A	55.4	12	22.2



SCREW-EM

Lock screw for endmill holders

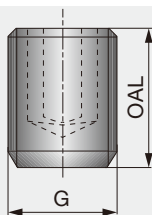

Designation	G	OAL	Applicable shank diameter
SRM6X10DIN1835B	M6	10	6
SRM8X10DIN1835-B	M8	10	8
SRM10X12DIN1835-B	M10	12	10
SRM12X16DIN1835-B	M12	16	12,14
SRM14X16DIN1835-B	M14	16	16,18
SRM16X16DIN1835-B	M16	16	20
SRM18X2X20DIN1835-B	M18X2	20	25
SRM20X2X20DIN1835-B	M20X2	20	32,40
SRM24X2X25DIN1835-B	M24X2	25	50
SRM16X10.3EMSHORT	M16	10.3	20
SRM18X2X10EMSHORT	M18X2	10	2

DIN
69871

PRESET SCREW

Preset screw with coolant hole for EME/SRKIN holders

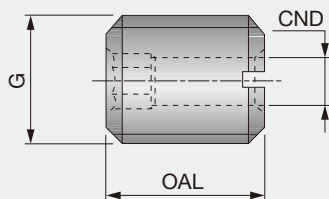

Designation	G	OAL	CND	Applicable shank	Wrench
PRESETSCREWM6X20B	M6X1	20	2.5	EME/SRKIN	3
PRESETSCREWM8X20B	M8X1.25	20	3.5	EME/SRKIN	4
PRESETSCREWM10X18B	M10X1.5	18	4.5	EME/SRKIN	5
PRESETSCREWM12X18B	M12X1.75	18	5.5	EME/SRKIN	6
PRESETSCREWM16X20B	M16X2	20	7.5	EME/SRKIN	6
PRESETSCREWM16X25B	M16X2	25	7.5	SRKIN	6

Side
lockCollet
chuckFace
millMilling
chuckHydro
chuckShrinking
chuck

Others

WRENCH SEMC

Wrench for face mill and shell mill combination type holders (DIN6368)

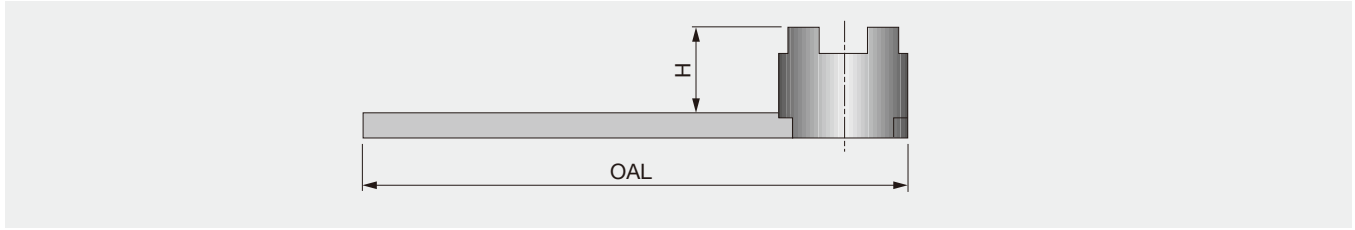

Designation	Clamping bore dia.	G	H	OAL
WRENCHM8SEMC16	16	M8	20	180
WRENCHM10SEMC22	22	M10	25	200
WRENCHM12SEMC27	25.4,27	M12	32	225
WRENCHM16SEMC32	31.75,32	M16	36	250
WRENCHM20SEMC40	38.1,40	M20	40	280
WRENCHM24SEMC50	50,50.8	M24	50	315

DRIVING RING SEMC

Driving ring for face mill and shell mill combination type holders (DIN6366/1)

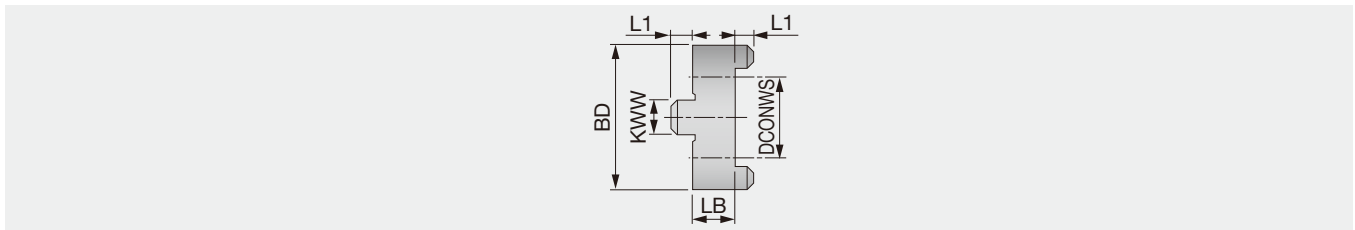

Designation	DCONWS	BD	LB	L1	KWW
16D.RINGSEMC	16	32	10	8	5
22D.RINGSEMC	22	40	12	10	6
27D.RINGSEMC	27	48	12	12	6.3
32D.RINGSEMC	32	58	14	14	7
40D.RINGSEMC	40	70	14	16	8
50D.RINGSEMC	50	90	16	18	9

Should be used with WRENCH SEMC.

COOLING TUBE-HSK

Cooling tube for HSK shank

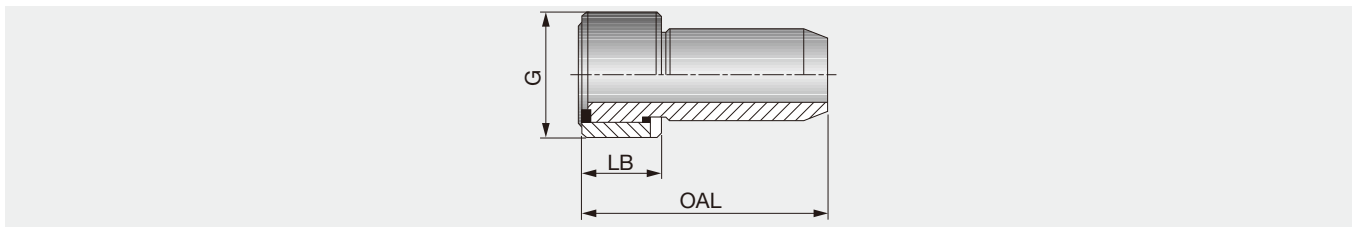

Designation	HSK size	OAL	LB	G
COOLINGTUBEHSKA40	40	29.1	7.5	M12X1
COOLINGTUBEHSKA50	50	32.7	9.5	M16X1
COOLINGTUBEHSKA63	63	36	11.5	M18X1
COOLINGTUBEHSKA80	80	36.6	13.5	M20X1.5
COOLINGTUBEHSKA100	100	43.6	15.5	M24X1.5

WRENCH

Wrench for HSK cooling tube

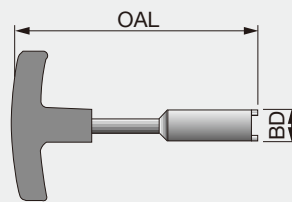

Designation	HSK size	BD	OAL
WRENCHCOOLTUBEHSK40	40	11	120
WRENCHCOOLTUBEHSK50	50	15	120
WRENCHCOOLTUBEHSK63	63	17	122
WRENCHCOOLTUBEHSK80	80	18.5	186
WRENCHCOOLTUBEHSK100	100	22	141

TOOL CLAMP

Tool clamp fixture for ISO, DIN69871, and BT MAS-403 BT shanks

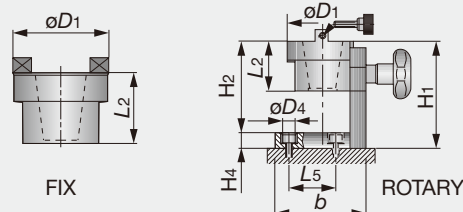

Designation	CSI	ϕD_1	L_2	H_1	H_2	H_4	b	L_5	ϕD_4
TOOLCLAMP30ROTARY	ROTARY	70	56	128	109	19	104	40	12.5
TOOLCLAMP40ROTARY	ROTARY	82	56	128	109	19	104	40	12.5
TOOLCLAMP50ROTARY	ROTARY	103	71	170	151	19	144	85	12.5
TOOLCLAMP30FIX	FIX	82	58	-	-	-	-	-	-
TOOLCLAMP40FIX	FIX	82	58	-	-	-	-	-	-
TOOLCLAMP50FIX	FIX	103	71	-	-	-	-	-	-

MULTI CLAMP (HSK)

Multi-clamp rotary fixture for HSK shank

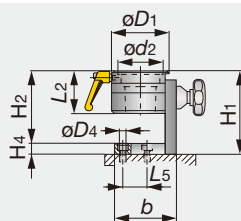

Designation	CSI	ϕd_2	ϕD_1	L_2	H_1	H_2	H_4	b	L_5	ϕD_4
MULTICLAMP32E/F	HSK A/C50	32	113.2	70	133	114	19	144	40	12.5
MULTICLAMP40E/F	HSK A/C63	40	113.2	70	133	114	19	144	40	12.5
MULTICLAMP63E/F	HSK E/F32	63	113.2	70	133	114	19	144	40	12.5
MULTICLAMP50A/C	HSK E/F40	50	82	72	142	123	19	104	40	12.5
MULTICLAMP63A/C	HSK E/F50	63	95	72	142	123	19	104	40	12.5
MULTICLAMP100A/C	HSK E/F63	100	130	90	178	159	19	144	85	12.5

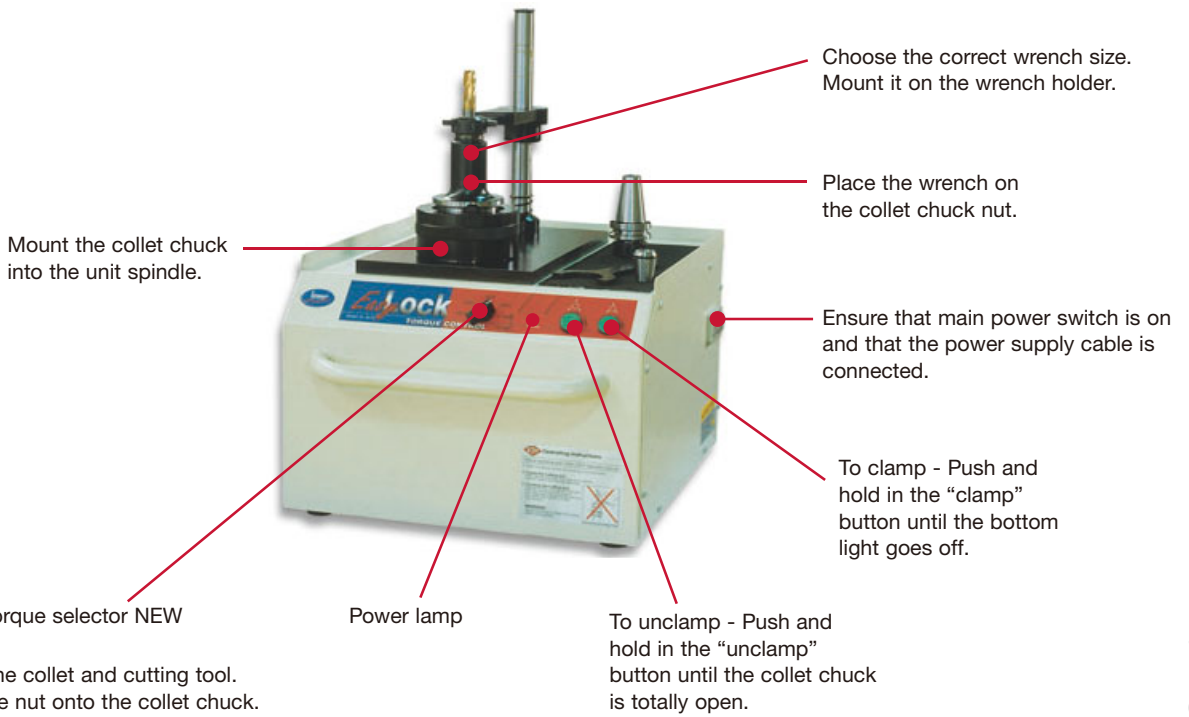

Designation	Machine
EASYLOCKT.CEU	200/240V 50/60 HZ

Grade **A**

Insert **B**

Ext. Toolholder **C**

Int. Toolholder **D**

Threading **E**

Grooving **F**

Miniature tool **G**

Milling cutter **H**

Endmill **I**

Drilling tool **J**

Tooling System **K**

User's Guide **L**

Index **M**

Coolant driven high speed compact spindle for ER32 collet chuck

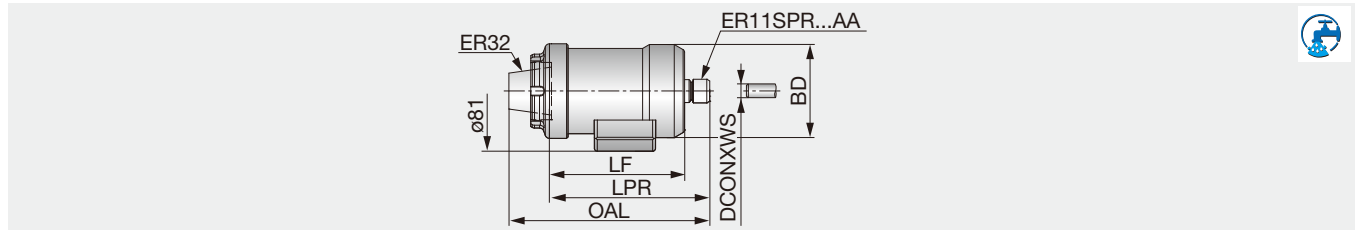

Designation	LF	LPR	OAL	BD	DCONXWS ⁽¹⁾	WT(kg)
TJSGJETER32	92	109	136	63	7	1.3

- Coolant pressure through machine spindle: Min. 2 MPa / Max. 4 MPa
- Min. flow rate: 12 l/min

(1) Max. tool shank diameter: $\varnothing 7$ mm

SPARE PARTS

Designation	Nut	Wrench for nut	Shaft lock key	Display (Optional)
TJSGJETER32	NUTER11GHS	WRENCHER11SMS	TJSSHAFTLOCKKEYGJET	TJSTSDDISPLAY***

TJS-BT

Coolant driven high speed compact spindle with BT shank

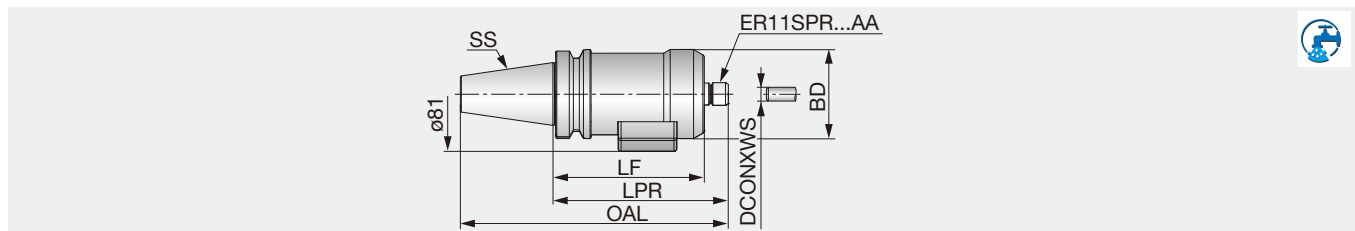

Designation	SS	LF	LPR	OAL	BD	DCONXWS ⁽¹⁾	WT(kg)
TJSGJETBT30	BT30	124	141	189	63	7	1.6
TJSGJETBT40	BT40	107	124	189	63	7	1.8

- Coolant pressure through machine spindle: Min. 2 MPa / Max. 4 MPa
- Min. flow rate: 12 l/min

(1) Max. tool shank diameter: $\varnothing 7$ mm

SPARE PARTS

Designation	Nut	Wrench for nut	Shaft lock key	Display (Optional)
TJSGJETBT...	NUTER11GHS	WRENCHER11SMS	TJSSHAFTLOCKKEYGJET	TJSTSDDISPLAY***

TJS-HSK A63

Coolant driven high speed compact spindle with HSK A63 shank

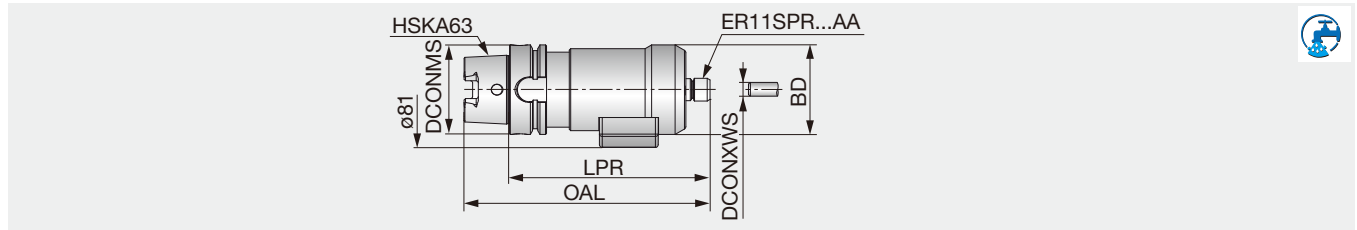

Designation	DCONMS	LPR	OAL	BD	DCONXWS ⁽¹⁾	WT(kg)
TJSGJETHSKA63	63	141	173	63	7	1.8

- Coolant pressure through machine spindle: Min. 2 MPa / Max. 4 MPa
- Min. flow rate: 12 l/min
- (1) Max. tool shank diameter: ø7 mm

SPARE PARTS

Designation	Nut	Wrench for nut	Shaft lock key	Display (Optional)
TJSGJETHSKA63	NUTER11GHS	WRENCHER11SMS	TJSSHAFTLOCKKEYGJET	TJSTSDDISPLAY***

TJS-C

Coolant driven high speed compact spindle with TungCap PSC shank

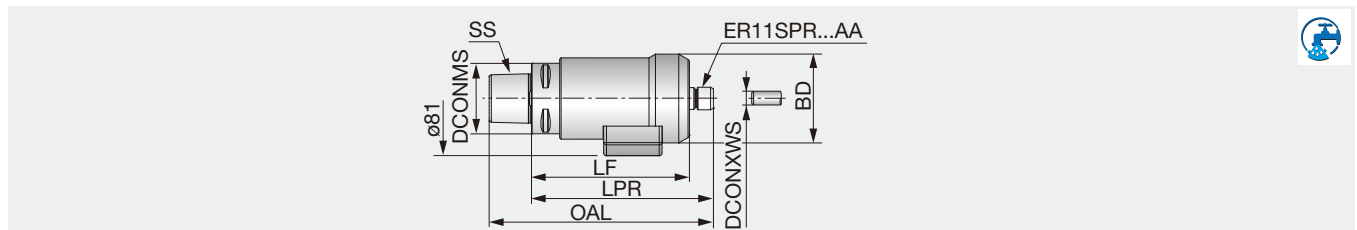

Designation	SS	DCONMS	LF	LPR	OAL	BD	DCONXWS ⁽¹⁾	WT(kg)
TJSGJETC5	C5	50	112	129	159	63	7	1.5
TJSGJETC6	C6	63	102	119	157	63	7	1.6

- Coolant pressure through machine spindle: Min. 2 MPa / Max. 4 MPa
- Min. flow rate: 12 l/min
- (1) Max. tool shank diameter: ø7 mm

SPARE PARTS

Designation	Nut	Wrench for nut	Shaft lock key	Display (Optional)
TJSGJETC...	NUTER11GHS	WRENCHER11SMS	TJSSHAFTLOCKKEYGJET	TJSTSDDISPLAY***

Grade
Insert
Ext. Toolholder
Int. Toolholder
Threading
Grooving
Milling cutter
Miniature tool
Endmill
Drilling tool
Tooling System
User's Guide
Index

A
B
C
D
E
F
G
H
I
J
K
L
M

Coolant driven high speed compact spindle with straight (cylindrical) shank

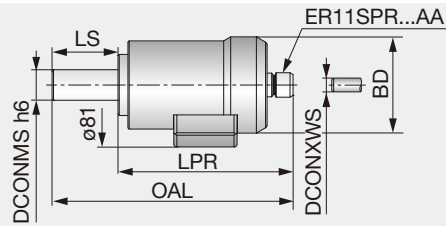

Designation	DCONMS	LS	LPR	OAL	BD	DCONXWS ⁽¹⁾	WT(kg)
TJSGJETST20	20	43	115	158	63	7	1.2

• Coolant pressure through machine spindle: Min. 2 MPa / Max. 4 MPa

• Min. flow rate: 12 l/min

(1) Max. tool shank diameter: ø7 mm

SPARE PARTS



Designation	Nut	Wrench for nut	Shaft lock key	Display (Optional)
TJSGJETST20	NUTER11GHS	WRENCHER11SMS	TJSSHAFTLOCKKEYGJET	TJSTSDDISPLAY***

TJS-CAT

Coolant driven high speed compact spindle with CAT shank

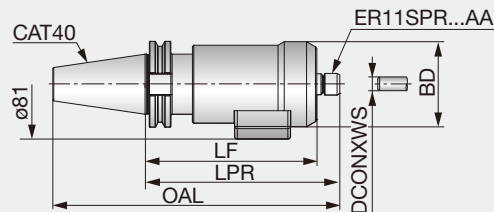

Designation	LF	LPR	OAL	BD	DCONXWS ⁽¹⁾	WT(kg)
TJSGJETCAT40	127	144	212	63	7	2

• Coolant pressure through machine spindle: Min. 2 MPa / Max. 4 MPa

• Min. flow rate: 12 l/min

(1) Max. tool shank diameter: ø7 mm

SPARE PARTS



Designation	Nut	Wrench for nut	Shaft lock key	Display (Optional)
TJSGJETCAT40	NUTER11GHS	WRENCHER11SMS	TJSSHAFTLOCKKEYGJET	TJSTSDDISPLAY***

Wireless RPM speed display

RPM speed display (SpinJet)

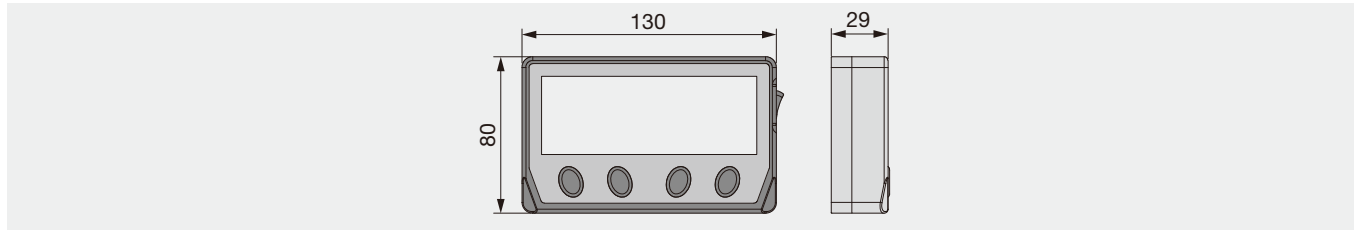

Designation



TJSTSDDISPLAYEUR	(for Europe)
TJSTSDDISPLAYUSA	(for the United States and Japan)

Adaptive product

TJS spindles
TJS spindles

Including plug adapter

- Plug adaptor for wireless RPM speed display

Type	TJSTSDDISPLAYEUR	TJSTSDDISPLAYUSA
Designation	TJSDISP.POWERSUPP-EUR	TJSDISP.POWERSUPP-USA
Appearance		

Plug adaptor is also sold separately.

New and old product comparison table

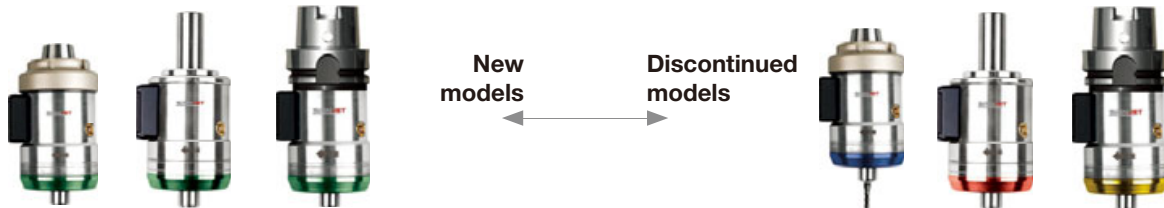

Alternative designation	Discontinued designation	Alternative designation	Discontinued designation
-	TJS20KBT30L	-	TJS40KC6L
TJSGJETBT30	TJS20KBT30R	TJSGJETC6	TJS40KC6R
-	TJS30KBT30L	-	TJS20KER32L
TJSGJETBT30	TJS30KBT30R	TJSGJETER32	TJS20KER32R
-	TJS40KBT30L	-	TJS30KER32L
TJSGJETBT30	TJS40KBT30R	TJSGJETER32	TJS30KER32R
-	TJS20KBT40L	-	TJS40KER32L
TJSGJETBT40	TJS20KBT40R	TJSGJETER32	TJS40KER32R
-	TJS30KBT40L	-	TJS20KHSKA63L
TJSGJETBT40	TJS30KBT40R	TJSGJETHSKA63	TJS20KHSKA63R
-	TJS40KBT40L	-	TJS30KHSKA63L
TJSGJETBT40	TJS40KBT40R	TJSGJETHSKA63	TJS30KHSKA63R
-	TJS20KCAT40L	-	TJS40KHSKA63L
TJSGJETCAT40	TJS20KCAT40R	TJSGJETHSKA63	TJS40KHSKA63R
-	TJS30KCAT40L	-	TJS20KDIN698714
TJSGJETCAT40	TJS30KCAT40R	-	TJS20KDIN6987140R
-	TJS40KCAT40L	-	TJS30KDIN698714
TJSGJETCAT40	TJS40KCAT40R	-	TJS30KDIN6987140R
-	TJS20KC5L	-	TJS30KDIN698714
TJSGJETC5	TJS20KC5R	-	TJS40KDIN6987140R
-	TJS30KC5L	-	TJS20KST20L
TJSGJETC5	TJS30KC5R	TJSGJETST20	TJS20KST20R
-	TJS40KC5L	-	TJS30KST20L
TJSGJETC5	TJS40KC5R	TJSGJETST20	TJS30KST20R
-	TJS20KC6L	-	TJS40KST20L
TJSGJETC6	TJS20KC6R	-	TJS40KST20R
-	TJS30KC6L	TJSGJETST20	
TJSGJETC6	TJS30KC6R		

- As of December 28, 2018, all orders for discontinued models are not accepted. As of December 31, 2020, all services and supports including repairs and spare part sales will end.



SPINJET

ER-SRK Shrink collet adapter

ER11 shrink collet adapter for induction heating device

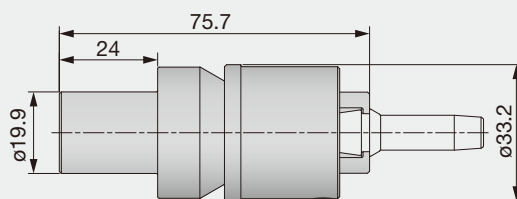

Designation

INDER11TOOLADAPTER

Adaptive product

TJS spindles

ER-SRK Shrink collet

ER11 shrink collet for induction heating device

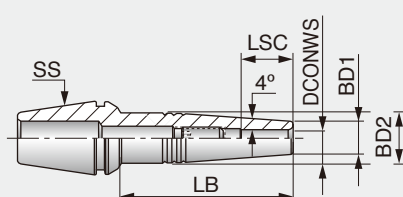

DIN 69871

HSK

BT MAS

DIN 2080

Others

Designation

Designation	SS	DCONWS	LB	LSC	BD2	BD1
ER11SRK3X10	ER11	3	10	9.5	8.5	7.6
ER11SRK3X25	ER11	3	25	11.5	8.5	7.6
ER11SRK4X10	ER11	4	10	9.5	8.5	7.6
ER11SRK4X25	ER11	4	25	11.5	8.5	7.6

• For carbide tools only

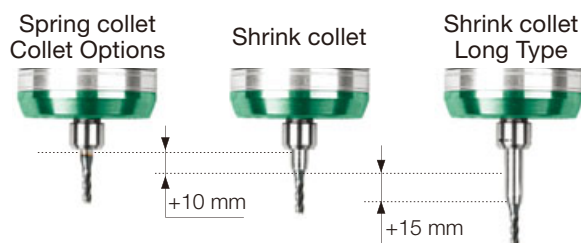

Side lock

Collet chuck

Face mill

Milling chuck

Hydro chuck

Shrinking chuck

Others

ER-SPR-AA

ER11 AA collet

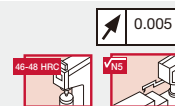
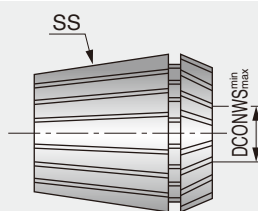

Designation

Designation	SS	DCONWS min	DCONWS max
ER11SPR0.5-1AA	ER11	0.5	1
ER11SPR1-2AA	ER11	1	2
ER11SPR2-3AA	ER11	2	3
ER11SPR3-4AA	ER11	3	4
ER11SPR4-5AA	ER11	4	5
ER11SPR5-6AA	ER11	5	6
ER11SPR6-7AA	ER11	6	7

• AA collet run-out: 0.005 mm

Nut and wrench for collets

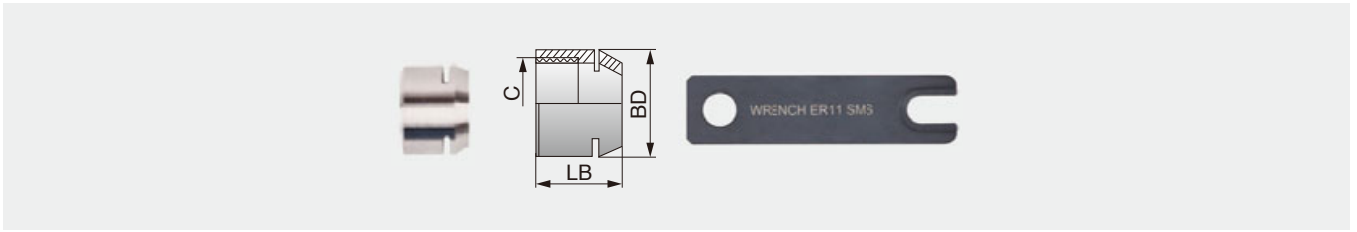

Designation	BD	LB	C	Wrench for nut
NUTER11GHS	16	11.5	M13X0.75	WRENCHER11SMS

Shaft lock key



Designation
TJSSHAFTLOCKKEYGJET

Grade

Insert

Ext. Toolholder

Int. Toolholder

Threading

Grooving

Miniature tool

Milling cutter

Endmill

Drilling tool

Tooling System

User's Guide

Index

A
B
C
D
E
F
G
H
I
J
K
L
M

FIXED TORQUE WRENCH



MERITS OF TORQUE CONTROL

High precision

Provides consistent torque levels, allowing extremely precise cutting edge positions.

longer tool life

Minimum axial runouts for reduced edge chipping risks.

WRENCH FEATURES

Easy setting

Multi-component handle optimally designed for the hand enables ideal torque transmission.

High repeatability and robustness

Close surface treatment on the blades ensures a superior engagement into the screw recess.

Easy setting

Handle

Multi-component handle optimally designed for the hand enables ideal torque transmission.



Mechanism

Driver clicks to alert the operator when the preset torque is attained. IDs printed on the handle end allow easy identification of the driver specs. Driver has unlimited loosening torque. Driver mechanism is industrial-lubricant-resistant.

High repeatability & robustness

Robustness / Fitting

Durability thanks to high quality steel, through hardened.

Versatility

Extra slim blade geometry is particularly suitable for applications with confined narrow access.

Dark green: TORX



Light green: TORX PLUS

Handle

Ex) **TW - D - 0.6NM**

1

2

3

1 Torque Wrench

2 Driver type

3 Torque

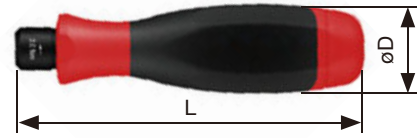

Designation	Stock	Torque (N·m)	Accuracy (%)	øD	L
TW-D-0.6NM	●	0.6	10	34	130
TW-D-0.9NM	●	0.9	10	34	130
TW-D-1.1NM	●	1.1	10	34	130
TW-D-1.4NM	●	1.4	10	34	130
TW-D-2.5NM	●	2.5	10	34	130
TW-D-3.0NM	●	3.0	10	34	130
TW-D-3.5NM	●	3.5	10	34	130

1 piece per package

Blade

Ex) **TW - B - T6**

1

2

3

1 Torque Wrench

2 Blade

3 TORX geom.

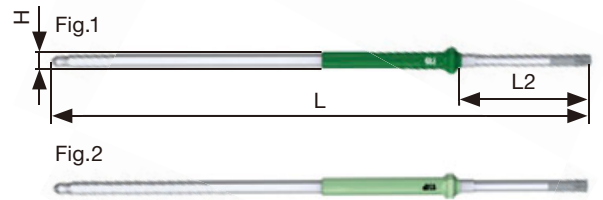

Designation	Stock	TORX geom.	H	L	L2	Fig.
TW-B-T6	●	T6	4	175	42	1
TW-B-T7	●	T7	4	175	42	1
TW-B-T8	●	T8	4	175	42	1
TW-B-T9	●	T9	4	175	42	1
TW-B-T10	●	T10	4	175	42	1
TW-B-T15	●	T15	4	175	42	1
TW-B-6IP	●	6IP	4	175	42	2
TW-B-7IP	●	7IP	4	175	42	2
TW-B-8IP	●	8IP	4	175	42	2
TW-B-10IP	●	10IP	4	175	42	2
TW-B-15IP	●	15IP	4	175	42	2

1 piece per package

Grade
Insert
Ext. Toolholder
Int. Toolholder
Threading
Grooving
Miniature tool
Milling cutter
Endmill
Drilling tool
Tooling System
User's Guide
Index

A
B
C
D
E
F
G
H
I
J
K
L
M

Wide range of variation quick change system

DIN69871A/D

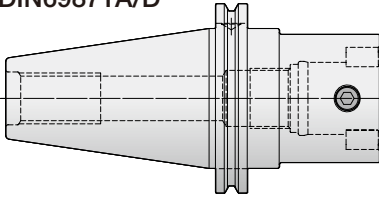

ANSI B5.50(CAT)

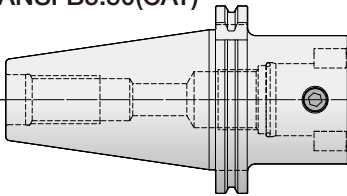

MAS-BT

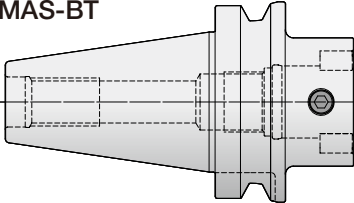

DIN69893(HSK A)

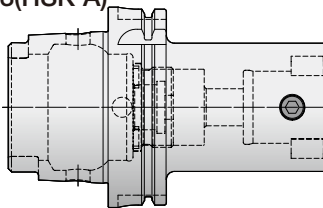

ISO26623-1(PSC)

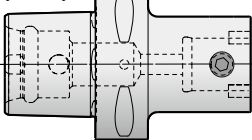

SK50 BT50

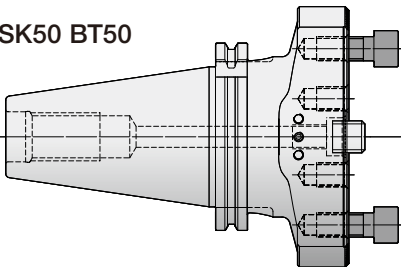

HSK-A100

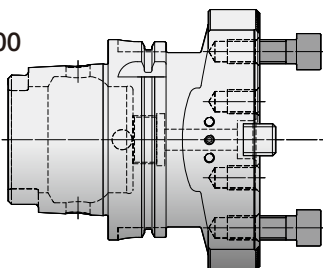

Reduction

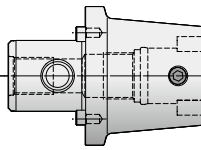

Extension

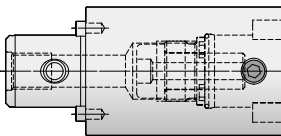

Bridge adaptor

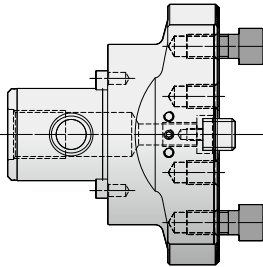
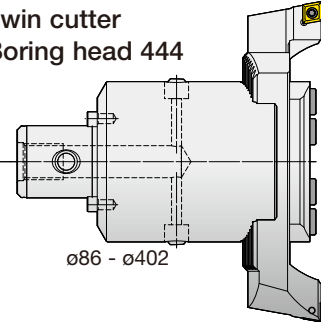
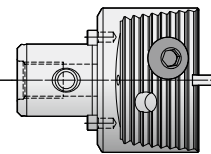
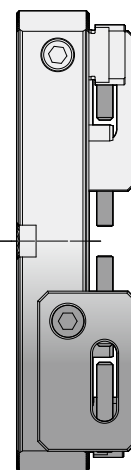
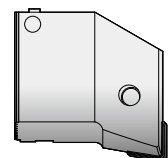
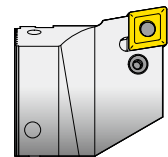
Twin cutter
Boring head 444
 $\varnothing 86 - \varnothing 402$
Twin cutter
Boring head 404
 $\varnothing 23.5 - \varnothing 153$
Extension
Bridge
 $\varnothing 150 - \varnothing 2205$
Boring head
570, 575, 580

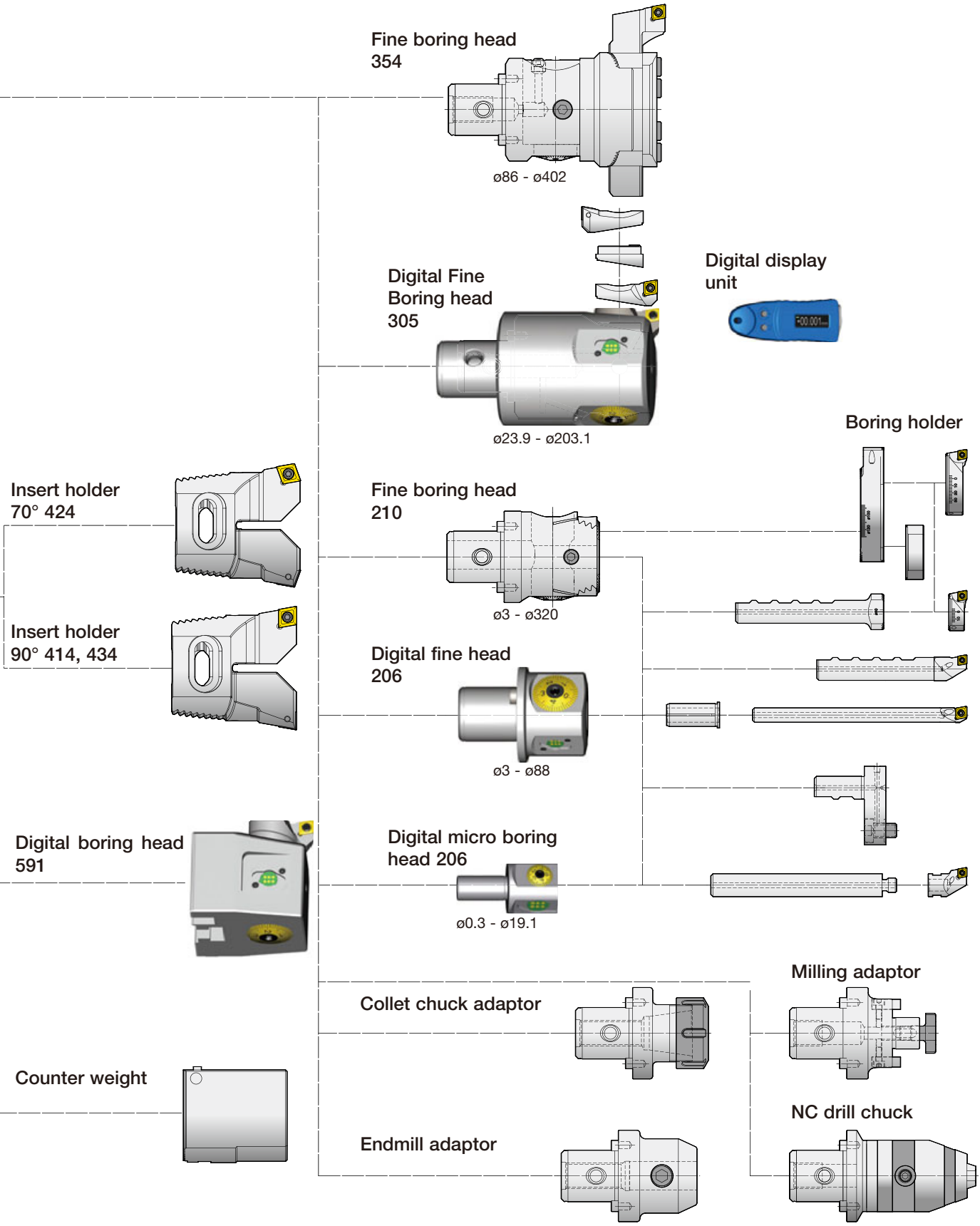

**Designation**

GH1-DA2.BG0.077

- High precision display unit with accuracy of 0.001 mm in diameter.
- Display unit features direct measurement system with no backlash.
- The illuminated display can be rotated 180 degrees to apply any measuring situation.
- mm/inch switchable
- Standard AAA battery installed.
- Magnet attachment

SPARE PARTS

Designation	Clamping screw ①	Screw wrench	Battery ②
GH1-DA2.BG0.077	900.309.022.008	900.308.011.045	AAA

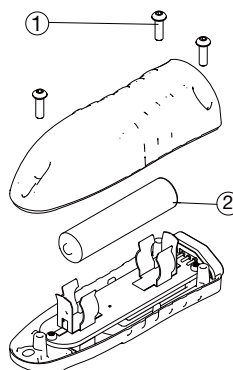
DIN
69871

HSK

BT
MASDIN
2080

Others

Side
lockCollet
chuckFace
millMilling
chuckHydro
chuckShrinking
chuck

Others

SwissBore206

Digital fine boring head $\varnothing 9.75 - \varnothing 88.1$

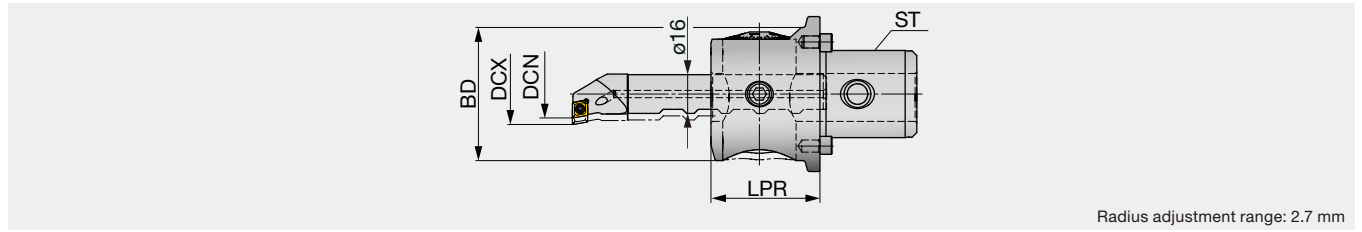

Designation	ST	BD	DCN	DCX	LPR
206.064.025.045	ST6	55	9.75	88.1	45

SPARE PARTS

Designation	Drive pin ①	Clamping screw ②	Fastening screw ③
206.***.025.***	900.102.064.000	900.204.010.008	900.204.010.008

Applicable for 3 MPa pressure coolant

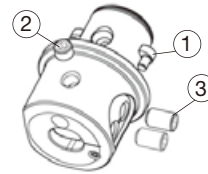

Boring bars 254,256
Option :Display unit GH1-DA2.BG0.077

SwissBore254

Boring bar $\varnothing 9.75 - \varnothing 30.1$

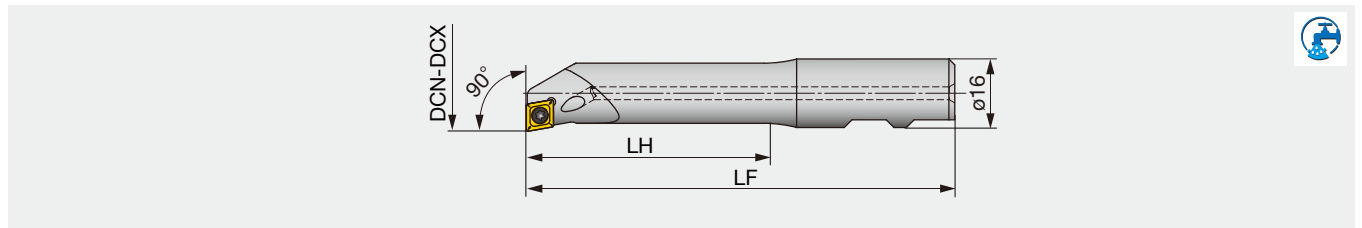

Designation	DCN	DCX	LH	LF	Insert
254.010.006.075	9.75	15.1	30	75	CC**0602...
254.015.006.090	14.75	20.1	51	90	CC**0602...
254.020.006.105	19.75	25.1	72	105	CC**0602...
254.025.006.115	24.75	30.1	82	115	CC**0602...

SPARE PARTS

Designation	Clamping screw	Screw wrench
254.0**006.***	CSTB-2.5S	T-8F

Reference pages: SwissBore254: Inserts → **B112** -, CBN → **B190** -, PCD → **B213**

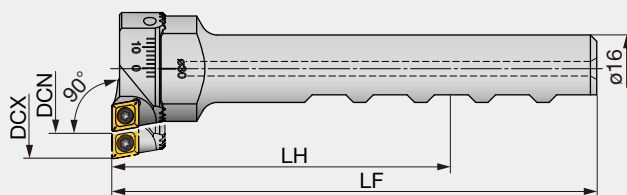

Designation (Shank)	Designation (Insert holder)	DCN	DCX	LH	LF	Insert
256.030.048.115	256.030.006.012	29.75	48.1	85	115	CC**0602...
256.048.088.115	256.048.006.014	47.75	88.1	85	115	CC**0602...

SPARE PARTS

Designation	Clamping screw ①	Clamping screw ②	Wrench
256.0**0**0**	900.256.005.016	CSTB-2.5S	T-8F

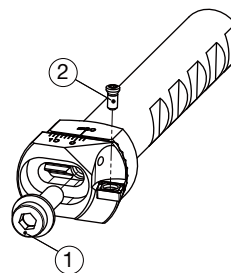

DIN 69871

HSK

BT MAS

DIN 2080

Others

Side lock

Collet chuck

Face mill

Milling chuck

Hydro chuck

Shrinking chuck

Others

SwissBore305

Digital fine boring head $\varnothing 23.9 - \varnothing 203.1$

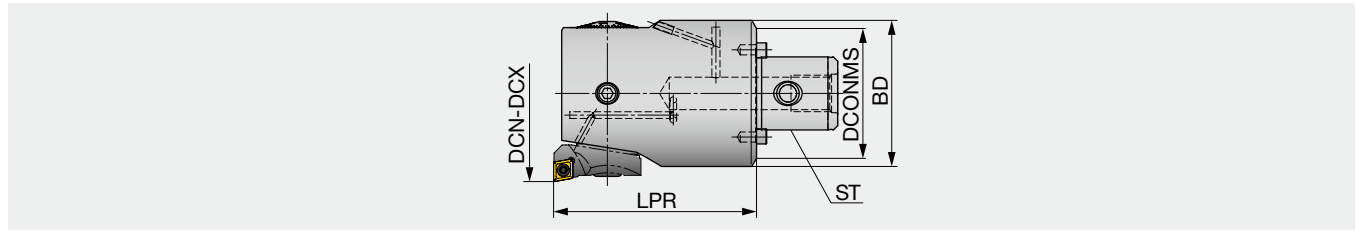

Designation	ST	DCN	DCX	DCONMS	BD	LPR	Insert holder
305.020.024.035	ST1	23.9	31.1	19.6	22.5	35.5	314.011.024.006/007
305.020.024.035	ST1	29.9	37.1	19.6	22.5	35.5	314.011.030.006/007
305.025.031.040	ST2	30.9	40.1	25	29	40	314.013.031.006/007
305.025.031.040	ST2	37.9	47.1	25	29	40	314.013.038.006/007
305.032.040.047	ST3	39.9	51.1	31.4	37	47	314.017.040.006/007
305.032.040.047	ST3	47.9	59.1	31.4	37	47	314.017.048.006/007
305.039.051.057	ST4	50.9	67.1	39	47	57	314.022.051.006/007
305.039.051.057	ST4	64.9	81.1	39	47	57	314.022.065.006/007
305.050.067.080	ST5	66.9	87.1	50	59	80	314.030.067.009/011
305.050.067.080	ST5	84.9	105.1	50	59	80	314.030.085.009/011
305.064.087.100	ST6+	86.9	116.1	64	72	100	314.030.067.009/011
305.064.087.100	ST6+	104.9	134.1	64	72	100	314.030.085.009/011
305.090.116.130	ST7+	115.9	153.1	90	94	130	314.030.067.009/011
305.090.116.130	ST7+	133.9	171.1	90	94	130	314.030.085.009/011
305.090.116.130	ST7+	153.9	191.1	90	94	130	314.726.003.009/011
305.090.116.130	ST7+	165.9*	203.1*	90	94	130	-

*Option : insert holder (314.726.003.009 or 314.726.003.011) & adapter (900.803.001.006)
Applicable for 7 MPa pressure coolant

SPARE PARTS

Designation	Drive pin ①	Clamping screw ②	Fastening screw ③
305.020.024.035	900.102.020.000	900.304.004.003	900.314.004.006
305.025.031.040	900.102.025.000	900.304.005.004	900.314.005.008
305.032.040.047	900.102.032.000	900.304.006.005	900.314.006.010
305.039.051.057	900.102.039.000	900.304.008.006	900.314.008.012
305.050.067.080	900.102.050.000	900.304.010.010	900.314.010.016
305.064.087.100	900.102.064.000	900.304.010.018	900.314.010.016
305.090.116.130	900.102.090.000	900.304.010.030	900.314.010.016

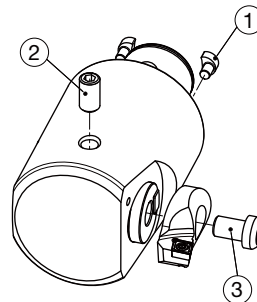

Reference pages: SwissBore305: Insert Holder → **K170**



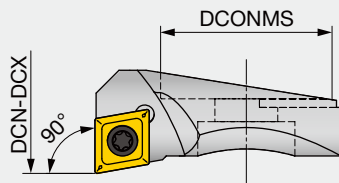

Designation	DCN	DCX	DCONMS	Insert	Boring head
314.011.024.006	23.9	31.1	11	CC**0602**	305.020.024.035
314.011.030.006	29.9	37.1	11	CC**0602**	305.020.024.035
314.013.031.006	30.9	40.1	13	CC**0602**	305.025.031.040
314.013.038.006	37.9	47.1	13	CC**0602**	305.025.031.040
314.017.040.006	39.9	51.1	17	CC**0602**	305.032.040.047
314.017.048.006	47.9	59.1	17	CC**0602**	305.032.040.047
314.022.051.006	50.9	67.1	22	CC**0602**	305.039.051.057
314.022.065.006	64.9	81.1	22	CC**0602**	305.039.051.057
314.030.067.009	66.9	87.1	30	CC**09T3**	305.050.067.080
314.030.085.009	84.9	105.1	30	CC**09T3**	305.050.067.080
314.030.067.009	86.9	116.1	30	CC**09T3**	305.064.087.100
314.030.085.009	104.9	134.1	30	CC**09T3**	305.064.087.100
314.030.067.009	115.9	153.1	30	CC**09T3**	305.090.116.130
314.030.085.009	133.9	171.1	30	CC**09T3**	305.090.116.130
314.726.003.009	153.9	191.1	30	CC**09T3**	305.090.116.130

SPARE PARTS



Designation	Clamping screw ①	Wrench ②
314.***.***006	CSTB-2.5S	T-8F
314.***.***009	CSTB-4S	T-15F

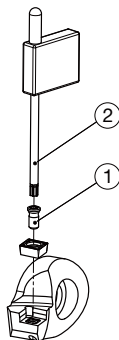

SwissBore314

Insert holder 90°corner for TP**insert

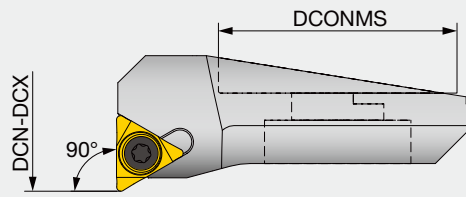

Designation	DCN	DCX	DCONMS	Insert	Boring head
314.011.024.007	23.9	31.1	11	TP**0701**	305.020.024.035
314.011.030.007	29.9	37.1	11	TP**0701**	305.020.024.035
314.013.031.007	30.9	40.1	13	TP**0701**	305.025.031.040
314.013.038.007	37.9	47.1	13	TP**0701**	305.025.031.040
314.017.040.007	39.9	51.1	17	TP**0701**	305.032.040.047
314.017.048.007	47.9	59.1	17	TP**0701**	305.032.040.047
314.022.051.007	50.9	67.1	22	TP**0701**	305.039.051.057
314.022.065.007	64.9	81.1	22	TP**0701**	305.039.051.057
314.030.067.011	66.9	87.1	30	TP**1102**	305.050.067.080
314.030.085.011	84.9	105.1	30	TP**1102**	305.050.067.080
314.030.067.011	86.9	116.1	30	TP**1102**	305.064.087.100
314.030.085.011	104.9	134.1	30	TP**1102**	305.064.087.100
314.030.067.011	115.9	153.1	30	TP**1102**	305.090.116.130
314.030.085.011	133.9	171.1	30	TP**1102**	305.090.116.130
314.726.003.011	153.9	191.1	30	TP**1102**	305.090.116.130

SPARE PARTS

Designation	Clamping screw ①	Wrench ②
314.***.***007	CSTB-2.2L038	T-7F
314.***.***011	CSTB-2.5S	T-8F

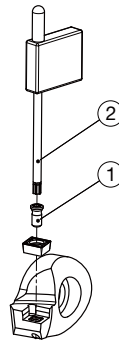

Reference pages: SwissBore314: Inserts → **B142 -**, CBN → **B199 -**, PCD → **B217**
 Boring Head → **K169**

SWISSBORE

SwissBore144

Master shank holders DIN 69893

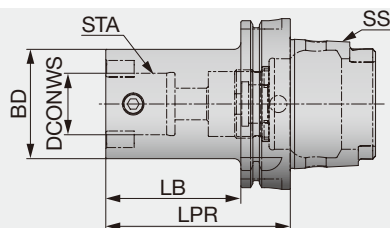

Designation	SS	STA	BD	DCONWS	LPR	LB
144.806.020.042	HSK A 63	ST1	20	11	42	16
144.806.025.042	HSK A 63	ST2	25	14	42	16
144.806.032.044	HSK A 63	ST3	32	18	44	18
144.806.039.048	HSK A 63	ST4	39	22	48	22
144.806.050.059	HSK A 63	ST5	50	28	59	33
144.806.064.070	HSK A 63	ST6	64	36	70	44
144.806.064.100	HSK A 63	ST6+	64	36	100	74
144.810.020.055	HSK A 100	ST1	20	11	55	26
144.810.025.055	HSK A 100	ST2	25	14	55	26
144.810.032.057	HSK A 100	ST3	32	18	57	28
144.810.039.061	HSK A 100	ST4	39	22	61	32
144.810.050.072	HSK A 100	ST5	50	28	72	43
144.810.064.078	HSK A 100	ST6	64	36	78	49
144.810.064.108	HSK A 100	ST6+	64	36	108	79
144.810.090.127	HSK A 100	ST7+	90	46	127	98

Option : Tension screw & Threading ring of ST+ type

SPARE PARTS



Clamping size	Clamping screw ①	O-ring ②	Tension screw ③ (Optional)	Threaded ring ④ (Optional)
ST1	900.100.004.005	900.101.008.002	-	-
ST2	900.100.005.006	900.101.011.002	-	-
ST3	900.100.006.008	900.101.015.002	-	-
ST4	900.100.008.011	900.101.019.002	-	-
ST5	900.100.010.012	900.101.025.002	-	-
ST6	900.100.012.018	900.101.032.002	-	-
ST6+	900.100.012.018	900.101.032.002	(900.102.018.040)	-
ST7+	900.100.020.029	900.101.043.002	(900.102.024.045)	-
HSK A 63	-	-	-	(900.104.030.014)
HSK A 100	-	-	-	(900.104.040.020)

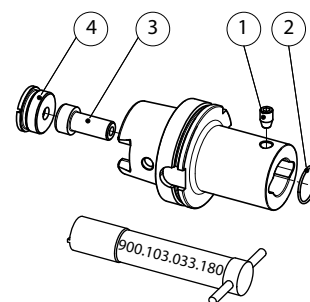

SwissBore154

Master shank holders PSC (TungCap)

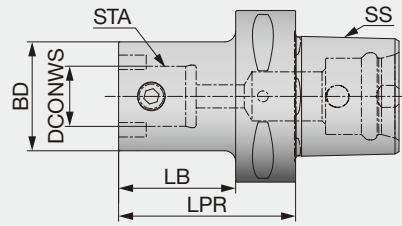

Designation	SS	STA	BD	DCONWS	LPR	LB
154.806.020.065	C6	ST1	20	11	65	43
154.806.025.065	C6	ST2	25	14	65	43
154.806.032.065	C6	ST3	32	18	65	43
154.806.039.058	C6	ST4	39	22	58	36
154.806.050.048	C6	ST5	50	28	48	26
154.806.064.059	C6	ST6	64	36	59	37
154.806.064.094	C6	ST6+	64	36	94	72

Option : Tension screw & Threading ring of ST+ type

SwissBore134

Master shank holder for MAS-BT

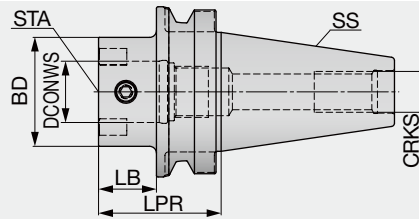

Designation	SS	STA	BD	DCONWS	LPR	LB	CRKS
134.530.050.038	BT30	ST5	50	28	38	16	M12
134.540.020.042	BT40	ST1	20	11	42	15	M16
134.540.025.042	BT40	ST2	25	14	42	15	M16
134.540.032.044	BT40	ST3	32	18	44	17	M16
134.540.039.048	BT40	ST4	39	22	48	21	M16
134.540.050.055	BT40	ST5	50	28	55	28	M16
134.540.064.046	BT40	ST6+	64	36	46	19	M16
134.550.020.063	BT50	ST1	20	11	63	25	M24
134.550.025.063	BT50	ST2	25	14	63	25	M24
134.550.032.065	BT50	ST3	32	18	65	27	M24
134.550.039.069	BT50	ST4	39	22	69	31	M24
134.550.050.072	BT50	ST5	50	28	72	34	M24
134.550.064.072	BT50	ST6+	64	36	72	34	M24
134.550.090.086	BT50	ST7+	90	46	86	48	M24

SPARE PARTS

Clamping size	Clamping screw ①	O-ring ②	Tension screw ③ (Optional)	Threaded ring ④ (Optional)
ST1	900.100.004.005	900.101.008.002	-	-
ST2	900.100.005.006	900.101.011.002	-	-
ST3	900.100.006.008	900.101.015.002	-	-
ST4	900.100.008.011	900.101.019.002	-	-
ST5	900.100.010.012	900.101.025.002	-	-
ST6+	900.100.012.018	900.101.032.002	(900.102.018.040)	(900.103.030.020)
ST7+	900.100.020.029	900.101.043.002	(900.102.024.045)	(900.103.040.020)

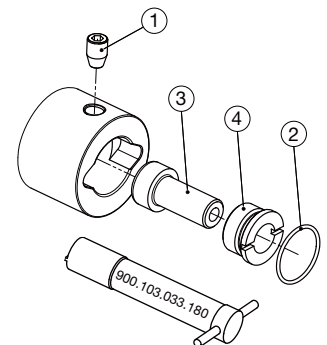

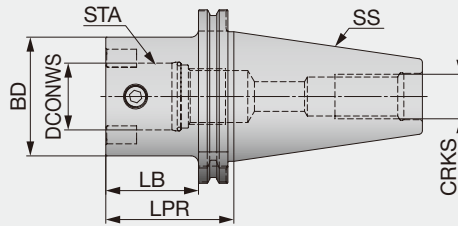

Designation	SS	STA	BD	DCONWS	LPR	LB	CRKS
114.430.050.050	SK30	ST5	50	28	50	30.9	M12
114.440.020.035	SK40	ST1	20	11	35	15.9	M16
114.440.025.040	SK40	ST2	25	14	40	20.9	M16
114.440.032.040	SK40	ST3	32	18	40	20.9	M16
114.440.039.043	SK40	ST4	39	22	43	23.9	M16
114.440.050.043	SK40	ST5	50	28	43	23.9	M16
114.440.064.059	SK40	ST6+	64	36	59	39.9	M16
114.450.020.045	SK50	ST1	20	11	45	25.9	M24
114.450.025.050	SK50	ST2	25	14	50	30.9	M24
114.450.032.050	SK50	ST3	32	18	50	30.9	M24
114.450.039.053	SK50	ST4	39	22	53	33.9	M24
114.450.050.053	SK50	ST5	50	28	53	33.9	M24
114.450.064.069	SK50	ST6+	64	36	69	49.9	M24
114.450.090.085	SK50	ST7+	90	46	85	65.9	M24

Option : Tension screw & Threading ring of ST+ type

SwissBore124

Master shank holders DIN 69871 B

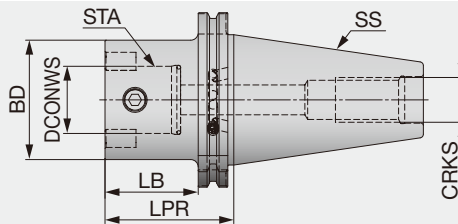

Designation	SS	STA	BD	DCONWS	LPR	LB	CRKS
124.440.020.035	SK40	ST1	20	11	35	15.9	M16
124.440.025.040	SK40	ST2	25	14	40	20.9	M16
124.440.032.040	SK40	ST3	32	18	40	20.9	M16
124.440.039.043	SK40	ST4	39	22	43	23.9	M16
124.440.050.043	SK40	ST5	50	28	43	23.9	M16
124.440.064.059	SK40	ST6+	64	36	59	39.9	M16
124.450.020.045	SK50	ST1	20	11	45	25.9	M24
124.450.025.050	SK50	ST2	25	14	50	30.9	M24
124.450.032.050	SK50	ST3	32	18	50	30.9	M24
124.450.039.053	SK50	ST4	39	22	53	33.9	M24
124.450.050.053	SK50	ST5	50	28	53	33.9	M24
124.450.064.069	SK50	ST6+	64	36	69	49.9	M24

Option : Tension screw & Threading ring of ST+ type

SPARE PARTS

Clamping size	Clamping screw ①	O-ring ②	Tension screw ③ (Optional)	Threaded ring ④ (Optional)
ST1	900.100.004.005	900.101.008.002	-	-
ST2	900.100.005.006	900.101.011.002	-	-
ST3	900.100.006.008	900.101.015.002	-	-
ST4	900.100.008.011	900.101.019.002	-	-
ST5	900.100.010.012	900.101.025.002	-	-
ST6	900.100.012.018	900.101.032.002	-	-
ST6+	900.100.012.018	900.101.032.002	(900.102.018.040)	(900.103.030.020)
ST7+	900.100.020.029	900.101.043.002	(900.102.024.045)	(900.103.040.020)

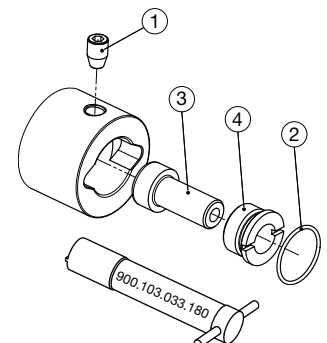

SwissBoreSP

Master shank holders DIN 69871 B2 with face contact

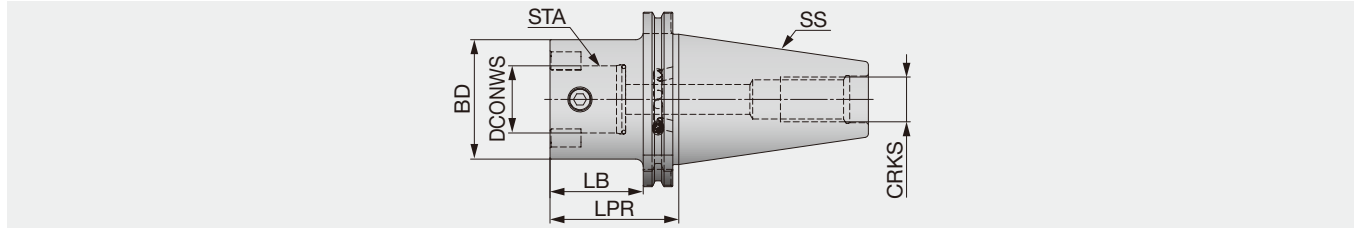

Designation	SS	STA	BD	DCONWS	LPR	LB	CRKS
SP4.ST5.K01.043	SK40	ST5	50	28	41	25	M16
SP4.ST6.K01.059	SK40	ST6	64	36	59	43	M16
SP5.ST5.K01.053	SK50	ST5	50	28	51	35	M24
SP5.ST6.K01.069	SK50	ST6	64	36	69	53	M24
SP5.ST6.K01.100	SK50	ST6+	64	36	100	84	M24
SP5.ST7.K01.100	SK50	ST7	90	46	100	84	M24

Option : Tension screw & Threading ring of ST+ type

SwissBore104

Master shank holders ANSI B5.50

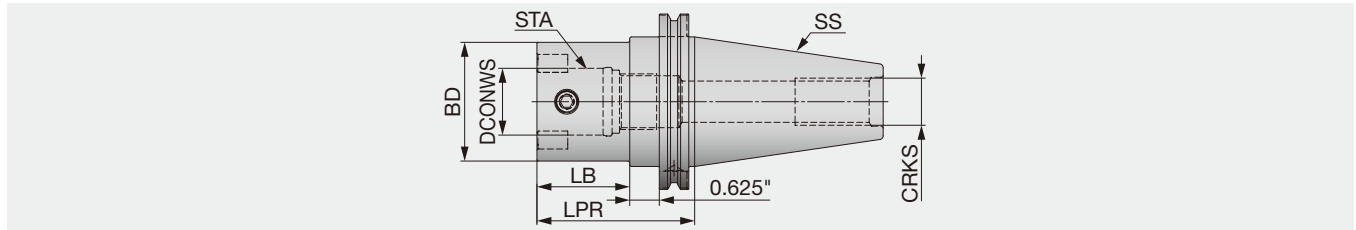

Designation	SS	STA	BD	DCONWS	LPR	LB	CRKS
104.340.020.051	CAT40	ST1	20	11	51	16	5/8"-11
104.340.025.056	CAT40	ST2	25	14	56	21	5/8"-11
104.340.032.056	CAT40	ST3	32	18	56	21	5/8"-11
104.340.039.059	CAT40	ST4	39	22	59	24	5/8"-11
104.340.050.059	CAT40	ST5	50	28	59	24	5/8"-11
104.340.064.075	CAT40	ST6+	64	36	75	40	5/8"-11
104.350.020.061	CAT50	ST1	20	11	61	26	1"-8
104.350.025.066	CAT50	ST2	25	14	66	31	1"-8
104.350.032.066	CAT50	ST3	32	18	66	31	1"-8
104.350.039.069	CAT50	ST4	39	22	69	34	1"-8
104.350.050.069	CAT50	ST5	50	28	69	34	1"-8
104.350.064.085	CAT50	ST6+	64	36	85	50	1"-8
104.350.090.085	CAT50	ST7+	90	46	85	50	1"-8

SPARE PARTS

Clamping size	Clamping screw ①	O-ring ②	Tension screw (Optional) ③	Threaded ring (Optional) ④
ST1	900.100.004.005	900.101.008.002	-	-
ST2	900.100.005.006	900.101.011.002	-	-
ST3	900.100.006.008	900.101.015.002	-	-
ST4	900.100.008.011	900.101.019.002	-	-
ST5	900.100.010.012	900.101.025.002	-	-
ST6	900.100.012.018	900.101.032.002	-	-
ST6+	900.100.012.018	900.101.032.002	(900.102.018.040)	(900.103.030.020)
ST7+	900.100.020.029	900.101.043.002	(900.102.024.045)	(900.103.040.020)

For SwissBore114, 124, 134 and 154

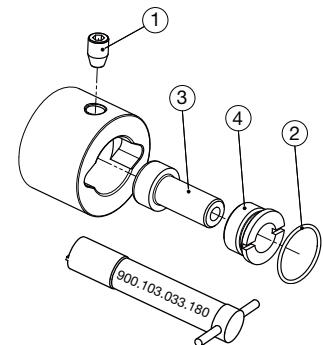

Grade

Insert

Ext. Toolholder

Int. Toolholder

Threading

Grooving

Miniature tool

Milling cutter

Endmill

Drilling tool

Tooling System

User's Guide

Index

SWISSBORE

SwissBore164

Extension adapter

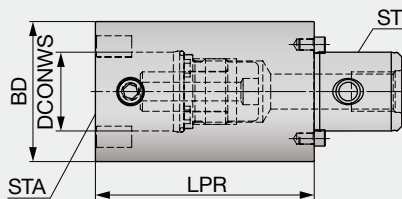

Designation	ST	STA	BD	DCONWS	LPR
164.020.020.020	ST1	ST1	20	11	20
164.020.020.030	ST1	ST1	20	11	30
164.025.025.030	ST2	ST2	25	14	30
164.025.025.045	ST2	ST2	25	14	45
164.032.032.030	ST3	ST3	32	18	30
164.032.032.045	ST3	ST3	32	18	45
164.039.039.040	ST4	ST4	39	22	40
164.039.039.060	ST4	ST4	39	22	60
164.050.050.060	ST5	ST5	50	28	60
164.050.050.090	ST5	ST5	50	28	90
164.064.064.060	ST6+	ST6+	64	36	60
164.064.064.100	ST6+	ST6+	64	36	100
164.090.090.100	ST7+	ST7+	90	46	100
164.090.090.160	ST7+	ST7+	90	46	160

Option : Tension screw & Threading ring of ST+ type

SPARE PARTS



Clamping size	Clamping screw ①	O-ring ②	Tension screw ③ (Optional)	Threaded ring ④ (Optional)	Drive pin ⑤
ST1	900.100.004.005	900.101.008.002	-	-	900.102.020.000
ST2	900.100.005.006	900.101.011.002	-	-	900.102.025.000
ST3	900.100.006.008	900.101.015.002	-	-	900.102.032.000
ST4	900.100.008.011	900.101.019.002	-	-	900.102.039.000
ST5	900.100.010.012	900.101.025.002	-	-	900.102.050.000
ST6+	900.100.012.018	900.101.032.002	(900.102.018.040)	(900.103.030.020)	900.102.064.000
ST7+	900.100.020.029	900.101.043.002	(900.102.024.045)	(900.103.040.020)	900.102.090.000

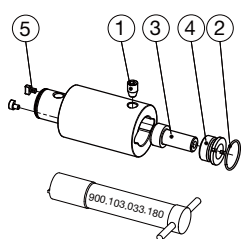

SwissBore184

Reduction adapter

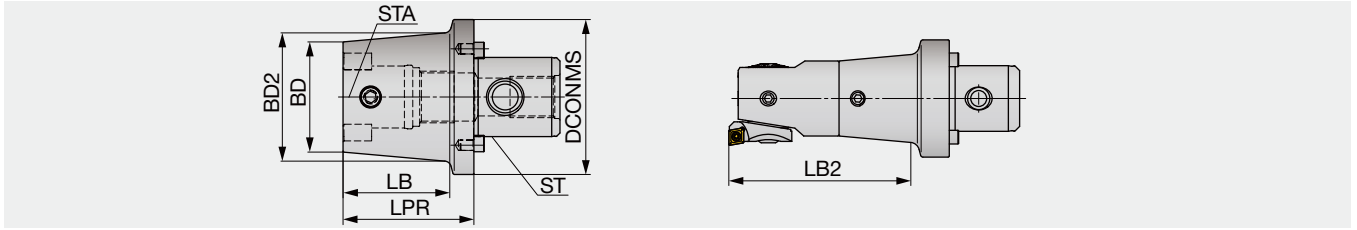

Designation	ST	STA	DCONMS	BD	BD2	LPR	LB	LB2
184.025.020.036	ST2	ST1	25	20	23	36	25	60.5
184.032.025.034	ST3	ST2	32	25	29	34.5	20	60
184.039.032.047	ST4	ST3	39	32	38	47	35	82
184.050.039.040	ST5	ST4	50	39	48	40	25.5	82.5
184.064.050.039	ST6+	ST5	64	50	60	39	24	104

LB2 : Max boring depth with twin cutter or fine boring head
 Option : Tension screw & Threading ring of ST+ type

SPARE PARTS



Clamping size	Clamping screw ①	O-ring ②	Tension screw ③ (Optional)	Threaded ring ④ (Optional)	Drive pin ⑤
ST1	900.100.004.005	900.101.008.002	-	-	900.102.020.000
ST2	900.100.005.006	900.101.011.002	-	-	900.102.025.000
ST3	900.100.006.008	900.101.015.002	-	-	900.102.032.000
ST4	900.100.008.011	900.101.019.002	-	-	900.102.039.000
ST5	900.100.010.012	900.101.025.002	-	-	900.102.050.000
ST6+	900.100.012.018	900.101.032.002	(900.102.018.040)	(900.103.030.020)	900.102.090.000

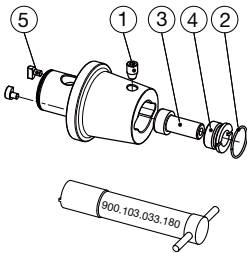

Grade

Insert

Ext. Toolholder

Int. Toolholder

Threading

Grooving

Miniature tool

Milling cutter

Endmill

Drilling tool

Tooling System

User's Guide

Index



PINZBOHR® Boring System



Features

Highly economical modular tool system

Tools are functionally classified and combined with arbor heads available in a wide variety of shapes and sizes to make up various ring tools. When used in diversified machining processes, this will help reduce the tooling costs considerably.

Applicable to a wide range of bore diameters from minimum $\varnothing 5.5$ to maximum $\varnothing 500$ mm

The head, for small diameter finish and applicable down to $\varnothing 5.5$ mm. The heads for roughing and finishing can cope with wide-ranging diameters from $\varnothing 24$ ~ $\varnothing 500$ mm when the head is changed and combined with fine adjustment function.

High rigidity and accuracy

The head and arbor are connected firmly with two tapered threads and drive key, ensuring high rigidity and superior repetition accuracy.

One action adjustment

The heads for rough boring can be adjusted in terms of two edge dimensions quickly in one action. The adjusting screw is protected with the damage prevention function.

Abundant insert variation

The inserts used are standard products complying with ISO. Insert grades and chipbreakers applied to various work materials and machining conditions are available in a wide range of shapes and sizes.

Variety of cartridges

The rough boring heads of $\varnothing 80$ mm or more in diameter are available with various inserts and step machining cartridges.



Part assembly

Coupling System

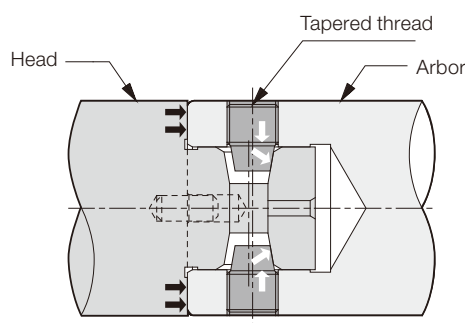

Strong rigid connection between Boring Head and Arbor.

Adjusting of Finishing Heads

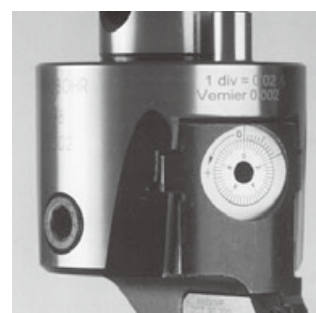

Adjusting Accuracy $\varnothing 0.002$ mm

Connection diameter

Arbor Designation

Ex) BT35042160

BD

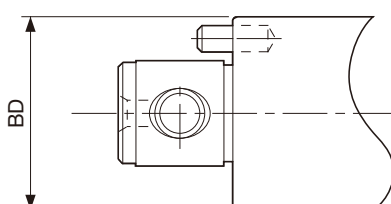

PINZBOHR® Boring System is a tie-up product with MYFHE, S. A.

See more information

e-catalog



System

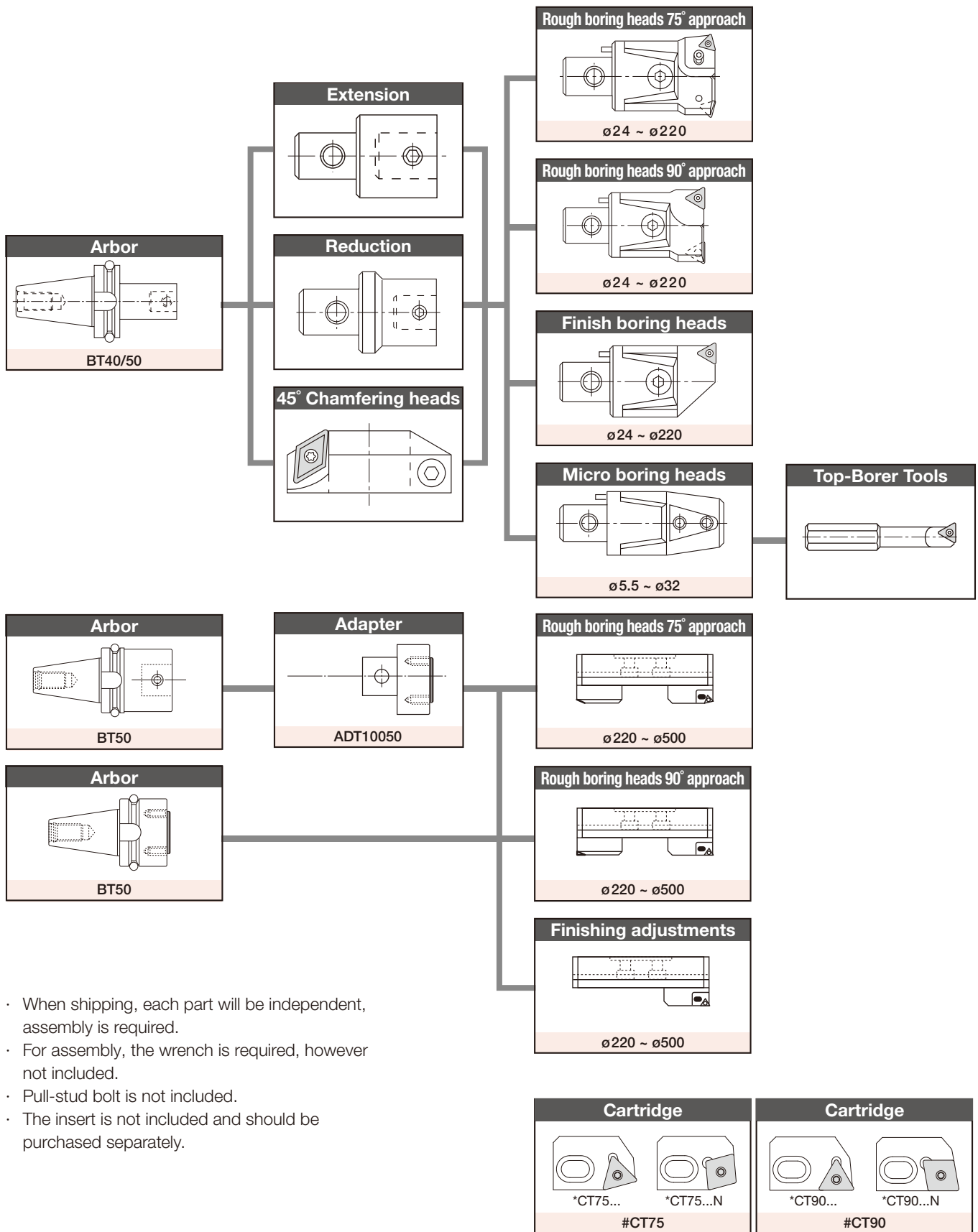

- When shipping, each part will be independent, assembly is required.
- For assembly, the wrench is required, however not included.
- Pull-stud bolt is not included.
- The insert is not included and should be purchased separately.

PINZBOHR® Boring System is a tie-up product with MYFHE, S. A.

Cartridge

Features of Cartridges

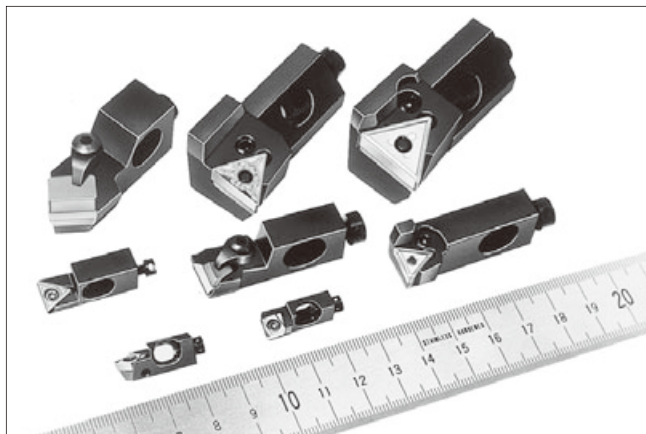

- Available in a wide range of shank sizes. (06CA ~ 20CA)
- Variety of types and sizes for a wide range of boring operations.

PN

Pin-lock type, negative rake cartridges excel in tooling economy.

SP

Screw-on type, positive rake cartridges featuring more free cutting action and machining accuracy.

CP

Clamp-on type, positive rake cartridges featuring a variety of styles and sizes.

CE

Clamp-on type, highly positive rake cartridges provide free cutting action and used for machining non-ferrous metals.

PNE





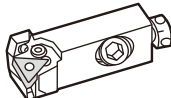
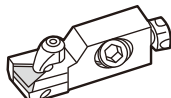
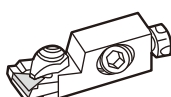
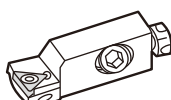
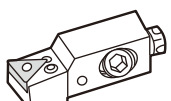
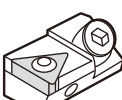





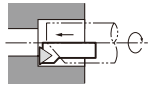
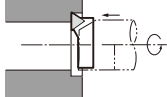
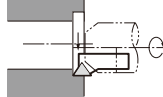

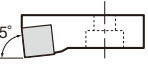
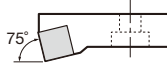

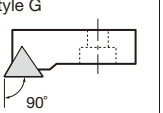
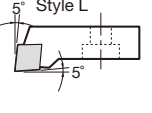

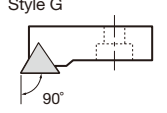
Pin-lock type, negative rake cartridges used only for external machining.

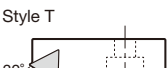
List of Cartridges

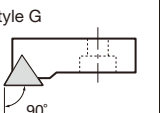
Type	Appearance	Size	Min. bore dia. (mm)	Cutting edge height (mm)	Rake angle	Applicable Insert		Clamping mechanism	No. of items	Features and notes
						Relief angle	Hole			
PN		10CA	40	10	Negative	0°	With ISO hole	Pin-lock	12	• Excellent in economy
		12CA	50	12					14	
		16CA	60	16					14	
		20CA	70	20					10	
CP		10CA	40	10	Positive	11°	Without	Clamp-on	16	• Tough insert • Variety of styles and sizes
		12CA	50	12					16	
		16CA	60	16					16	
		20CA	70	20					2	
CE		10CA	40	10	Positive	20°	Without	Clamp-on	16	• More free cutting action • Best suitable for machining non-ferrous metals
		12CA	50	12					16	
SP		06CA	20	6	Positive	11°	With ISO hole	Screw-on	10	• Provides free cutting action • Good chip control
		08CA	25	8					10	
		10CA	40	10					16	
		12CA	50	12					16	
PNE		10CA	—	10	Negative	0°	With ISO hole	Pin-lock	8	• For external use • Made to order
		12CA	—	12					10	
A		(09CA) (Corresponds to 09CA)	32	9	Positive	11°	With Tungaloy's standard hole	Screw-on	12	• Mini-cartridge

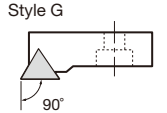
Note: Min. bore diameters shown above are for axial mounting.

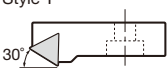
List of ISO Standard Cartridges by Application

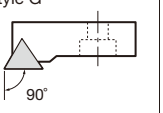
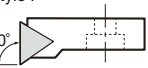
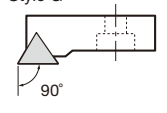
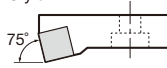
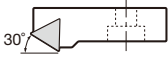
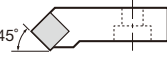
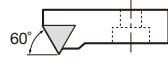
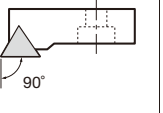
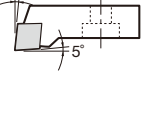
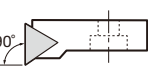
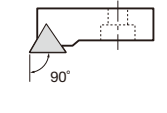
Type	Boring		Chamfering and boring			Facing and boring	
			External and internal 45° chamfering (PSSN type can not be used for external chamfering)				
PN	Cutting edge angle 85° Style Y 	Cutting edge angle 75° Style K 	Cutting edge angle 30°	Cutting edge angle 45°		Cutting edge angle 0°	Cutting edge angle 5°
	PSYN K196	PSKN K186	Style T 	Style S 		Style G 	5° Style L 
	Cutting edge angle 90° Style F 	Cutting edge angle 0° Style G 					
	PTFN K182	PTGN K184	PTTN K194	PSSN K190		PTGN K184	PCLN K188
CP	Cutting edge angle 85° Style Y 	Cutting edge angle 75° Style K 	Cutting edge angle 30°	Cutting edge angle 45°	Cutting edge angle 60°	Cutting edge angle 0°	
	CSYP K196	CSKP K186	Style T 	Style S (Square insert) 	Style W 	Style G 	
	Cutting edge angle 90° Style F 	Cutting edge angle 90° Style G 		CSSP K191			
	CTFP K182	CTGP K184	CTTP K194	CTSP K192	CTWP K189	CTGP K184	
CE		Cutting edge angle 75° Style K 	Cutting edge angle 30°	Cutting edge angle 45°		Cutting edge angle 0°	
		CSKE K187	Style T 	Style S (Square insert) 		Style G 	
	Cutting edge angle 90° Style F 	Cutting edge angle 90° Style G 		CSSE K191			
	CTFE K183	CTGE K185	CTTE K195	CTSE K193		CTGE K185	
SP	Cutting edge angle 85° Style Y 	Cutting edge angle 75° Style K 	Cutting edge angle 30°	Cutting edge angle 45°	Cutting edge angle 60°	Cutting edge angle 0°	Cutting edge angle 5°
	SSYP K197	SSKP K198	Style T (80° rhombic only for 06CA) 	Style S (Square insert) (80° rhombic only for 06CA) 	Style W 	Style G (80° rhombic only for 06CA) 	5° Style L 
	Cutting edge angle 90° Style F (80° rhombic only for 06CA) 	Cutting edge angle 0° Style G (80° rhombic only for 06CA) 		SSSP K192			
	STFP K183 SCFP K183 (06CA)	STGP K185	STTP K195 SCTP K195 (06CA)	STSP K193 SCSP K193 (06CA)	STWP K189	STGP K185	SCLP K188 (06CA)

Please see the each product page (K***) for the product details.



PN PTFN-CA

Lever-lock cartridge, with 90° approach angle, for negative 60° triangular inserts

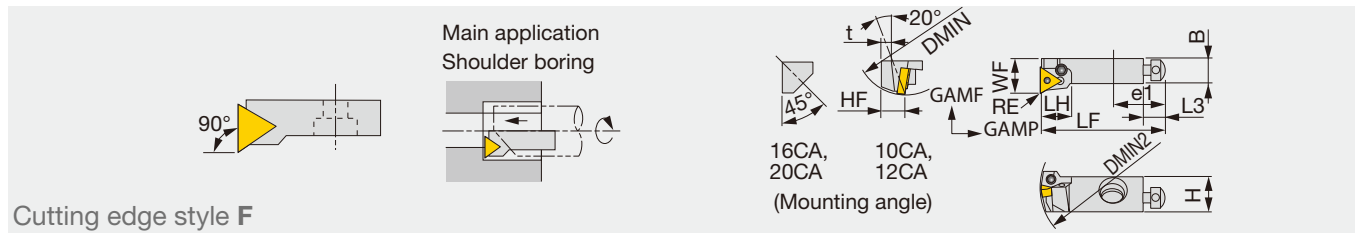

Designation	DMIN	DMIN2	RE**	WF	LF	LH	HF	H	B	e1	L3	GAMF	GAMP	t	Insert
PTFNR/L10CA-11	40	55	0.4	14	50	12	10	14.5	10	20	8	-6°	-8°	5	TN**1103...
PTFNR/L12CA-16	50	75	0.8	20	55	16	12	19.5	15	20	8	-6°	-8°	6	TN**1604...
PTFNR/L16CA	55	-	0.8	25	63	23	16	16	17	25	8	-6°	-8°	0	TN**1604...
PTFNR/L20CA	70	-	0.8	25	70	28	20	20	19	30	10	-6°	-7°	0	TN**2204...

- In the above table, DMIN is the minimum bore diameter for axial mounting, and DMIN2 is for radial mounting.
- When using a right or left hand insert, use right-hand cartridges (R) with left-hand inserts (L); and left-hand cartridges (L) with right-hand inserts (R).
- **RE: Standard corner radius

SPARE PARTS

Designation	Shim	Lever	Clamping screw	Axial adjusting screw	Radial adjusting screw	Cartridge setting screw	Wrench	Shim retainer	Sizing plate (Optional parts)	Sizing plate ass'y (Optional parts)
PTFNR/L10CA-11	-	LCL22N	LCS22	ASM54	SSH4-4	CHHM6-15	P-2F,P-5	-	-	PSTR/L10
PTFNR/L12CA-16	-	LCL33N	LCS33	ASM54	SSH4-4	CHHM6-25	P-2F,P-5	-	-	PSTR/L12
PTFNR/L16CA	LST317CA	LCL3	LCS3	ASM6	SSH5-6	BHM8-25U	P-2.5,P-5	LSP3	S0816B/S1016B	-
PTFNR/L20CA	LST42CA	LCL4	LCS4	ASM6	SSH5-6	BHM8-30U	P-2.5,P-3,P-5	LSP4	S0820B/S1020B	-

CP CTFP-CA

Clamp-on cartridge, with 90° approach angle, for 11° clearance triangular inserts

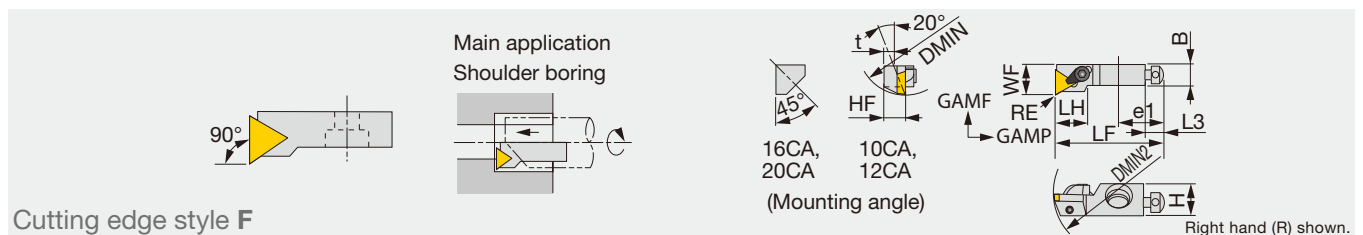

Designation	DMIN	DMIN2	RE**	WF	LF	LH	HF	H	B	e1	L3	GAMF	GAMP	t	Insert
CTFPR/L10CA-11	40	55	0.4	14	50	15	10	14.5	10	20	8	4°	0°	5	TP**1103...
CTFPR/L12CA-16	50	75	0.8	20	55	17	12	19.5	15	20	8	5°	2°	6	TP**1603...
CTFPR/L16CA	55	-	0.8	25	63	23	16	16	17	25	8	5°	0°	0	TP**1603...
CTFPR/L20CA	70	-	0.8	25	70	22	20	20	19	30	10	5°	0°	0	TP**2204...

- In the above table, DMIN is the minimum bore diameter for axial mounting, and DMIN2 is for radial mounting.
- When using a right or left hand insert, use right-hand cartridges (R) with left-hand inserts (L); and left-hand cartridges (L) with right-hand inserts (R).
- **RE: Standard corner radius

SPARE PARTS

Designation	Shim	Shim screw	Clamping screw	Axial adjusting screw	Radial adjusting screw	Cartridge setting screw	Wrench	Chipbreaker piece	Sizing plate (Optional parts)	Sizing plate ass'y (Optional parts)
CTFPR/L10CA-11	-	-	CSG-5 (CSG-5S)	ASM54	SSH4-10	CHHM6-15	P-2,P-2.5,P-5	CBT-2M	-	PSTR/L10
CTFPR/L12CA-16	-	-	CSG-6 (CSG-6S)	ASM54	SSH4-14	CHHM6-25	P-2,P-3,P-5	CBT-3M	-	PSTR/L12
CTFPR/L16CA	PAT-32	SM3X0.5X8	CSG-8S	ASM6	SSH5-16	BHM8-25U	P-2.5,P-4	-	S0816B/S1016B	-
CTFPR/L20CA	PAT-42	SM3X0.5X8	CSG-8	ASM6	SSH6-16	BHM8-30U	P-3,P-4	-	S0820B/S1020B	-

- Cartridges for K-style cutting edge: S0816A or S1016A; S-style cutting edge: S0816C or S1016B
- When not using chipbreaker piece, clamping screw in () should be used.

Reference pages: PN PTFN-CA: Inserts → **B087** -, CBN → **B182** -, PCD → **B212** -
 CP CTFP-CA: Inserts → **B142** -, CBN → **B199** -, PCD → **B217** -

CE CTFE-CA

Clamp-on cartridge, with 90° approach angle, for 20° clearance triangular inserts

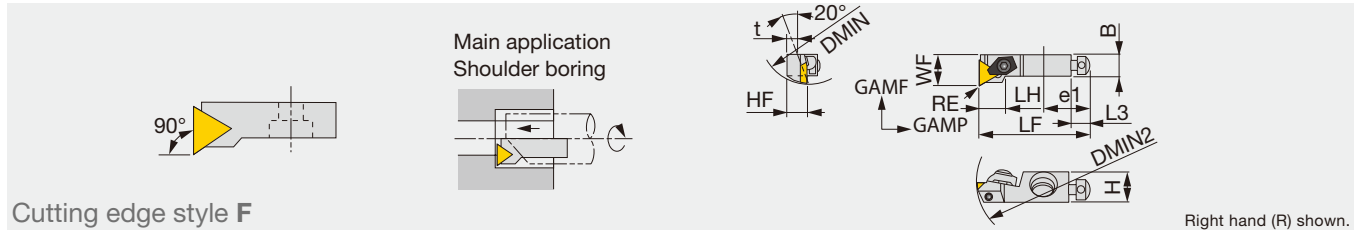

Designation	DMIN	DMIN2	RE**	WF	LF	LH	HF	H	B	e1	L3	GAMF	GAMP	t	Insert
CTFER/L10CA-11	40	55	0.4	14	50	12	10	14.5	10	20	8	10°	5°	5	TE**1103...
CTFER/L12CA-16	50	75	0.8	20	55	18	12	19.5	15	20	8	10°	5°	6	TE**1603...

- In the above table, DMIN is the minimum bore diameter for axial mounting, and DMIN2 is for radial mounting.
- When using a right or left hand insert, use right-hand cartridges (R) with left-hand inserts (L); and left-hand cartridges (L) with right-hand inserts (R).
- **RE: Standard corner radius

SPARE PARTS

Designation	Clamping screw	Axial adjusting screw	Radial adjusting screw	Cartridge setting screw	Wrench	Chipbreaker piece	Sizing plate ass'y (Optional parts)
CTFER/L10CA-11	CSW-40	ASM54	SSHM4-8	CHHM6-15	P-2,P-2.5,P-5	CBT-2M	PSTR/L10
CTFER/L12CA-16	CSW-50	ASM54	SSHM4-14	CHHM6-25	P-2,P-3,P-5	CBT-3M	PSTR/L12

SP STFP-CA / SCFP-CA

Screw-on cartridge, with 90° approach angle, for 11° clearance triangular inserts and rhombic inserts

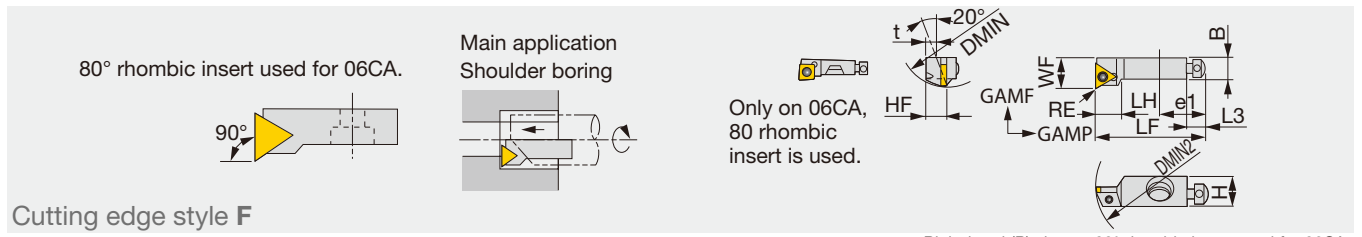

Designation	DMIN	DMIN2	RE**	WF	LF	LH	HF	H	B	e1	L3	GAMF	GAMP	t	Insert
SCFPR/L06CA-05	20	30	0.4	8	25	8.5	6	7.5	5.5	12	4.5	0°	0°	3.5	CP**0502...
STFPR/L08CA-09	25	35	0.4	10	32	10	8	11.5	7.5	17	6	4°	0°	4.5	TP**0902...
STFPR/L10CA-11	40	55	0.4	14	50	12	10	14.5	10	20	8	4°	0°	5	TP**1102...
STFPR/L12CA-16	50	75	0.8	20	55	17	12	19.5	15	20	8	5°	2°	6	TP**16T3...

- In the above table, DMIN is the minimum bore diameter for axial mounting, and DMIN2 is for radial mounting.
- When using a right or left hand insert, use right-hand cartridges (R) with left-hand inserts (L); and left-hand cartridges (L) with right-hand inserts (R).
- **RE: Standard corner radius

SPARE PARTS

Designation	Clamping screw	Axial adjusting screw	Radial adjusting screw	Cartridge setting screw	Wrench	Torx wrench	Sizing plate ass'y (Optional parts)
SCFPR/L06CA-05	CSTB-2.2S	ASM34S	SSHM3-6	CHHM3.5-10	P-1.5,P-3	T-7F	PT06
STFPR/L08CA-09	CSTB-2.2S	ASM34L	SSHM3-6	CHHM4-10	P-1.5,P-3	T-7F	PSTR/L08
STFPR/L10CA-11	CSTB-2.5	ASM54	SSHM4-10	CHHM6-15	P-2,P-5	T-8F	PSTR/L10
STFPR/L12CA-16	CSTB-4S	ASM54	SSHM4-14	CHHM6-25	P-2,P-5	T-15F	PSTR/L12

Reference pages: CE CTFE-CA: Inserts → Special

SP STFP-CA: Inserts → **B118** (CP**), **B142** - (TP**), CBN → **B199** -, PCD → **B217** -

PN PTGN-CA

Lever-lock cartridge, with 90° approach angle, for negative 60° triangular inserts

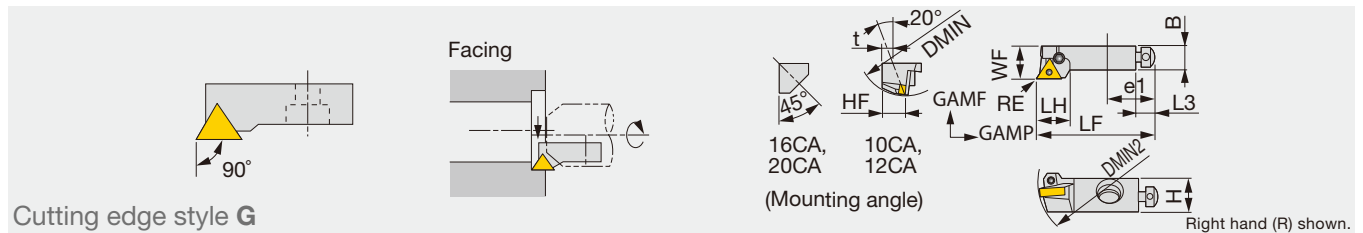

Designation	DMIN	DMIN2	RE**	WF	LF	LH	HF	H	B	e1	L3	GAMF	GAMP	t	Insert
PTGNR/L10CA-11	40	55	0.4	14	50	14	10	14.5	10	20	8	-6°	-8°	5	TN**1103...
PTGNR/L12CA-16	50	75	0.8	20	55	20	12	19.5	15	20	8	-6°	-8°	5	TN**1604...
PTGNR/L16CA	60	75	0.8	25	63	23	16	16	17	25	8	-6°	-10°	0	TN**1604...
PTGNR/L20CA	70	90	0.8	25	70	28	20	20	19	30	10	-6°	-8°	0	TN**2204...

- In the above table, DMIN is the minimum bore diameter for axial mounting, and DMIN2 is for radial mounting.
- **RE: Standard corner radius

SPARE PARTS

Designation	Shim	Lever	Clamping screw	Axial adjusting screw	Radial adjusting screw	Cartridge setting screw	Wrench	Shim retainer	Sizing plate (Optional parts)	Sizing plate ass'y (Optional parts)
PTGNR/L10CA-11	-	LCL22N	LCS22	ASM54	SSHM4-4	CHHM6-15	P-2F,P-5	-	-	PSTR/L10
PTGNR/L12CA-16	-	LCL33N	LCS33	ASM54	SSHM4-4	CHHM6-25	P-2F,P-5	-	-	PSTR/L12
PTGNR/L16CA	LST317CA	LCL3	LCS3	ASM6	SSHM5-6	BHM8-25U	P-2.5,P-5	LSP3	S0816B/S1016B	-
PTGNR/L20CA	LST42CA	LCL4	LCS4	ASM6	SSHM5-6	BHM8-30U	P-2.5,P-3,P-5	LSP4	S0820B/S1020B	-

CP CTGP-CA

Clamp-on cartridge, with 90° approach angle, for 11° clearance triangular inserts

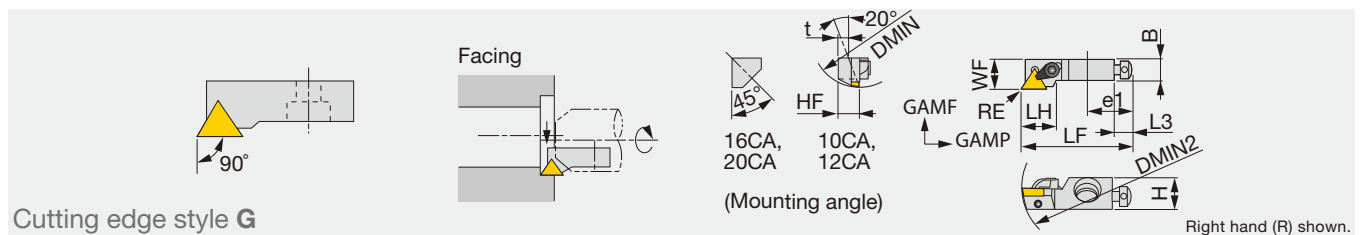

Designation	DMIN	DMIN2	RE**	WF	LF	LH	HF	H	B	e1	L3	GAMF	GAMP	t	Insert
CTGPR/L10CA-11	40	55	0.4	14	50	16	10	14.5	10	20	8	4°	0°	5	TP**1103...
CTGPR/L12CA-16	50	75	0.8	20	55	21	12	19.5	15	20	8	3°	2°	5	TP**1603...
CTGPL16CA	55	75	0.8	25	63	25	16	16	17	25	8	0°	0°	0	TP**1603...

- In the above table, DMIN is the minimum bore diameter for axial mounting, and DMIN2 is for radial mounting.
- **RE: Standard corner radius

SPARE PARTS

Designation	Shim	Shim screw	Clamping screw	Axial adjusting screw	Radial adjusting screw	Cartridge setting screw	Wrench	Chipbreaker piece	Sizing plate (Optional parts)	Sizing plate ass'y (Optional parts)
CTGPR/L10CA-11	-	-	CSG-5 (CSG-5S)	ASM54	SSHM4-10	CHHM6-15	P-2,P-2.5,P-5	CBT-2M	-	PSTR/L10
CTGPR/L12CA-16	-	-	CSG-6 (CSG-6S)	ASM54	SSHM4-14	CHHM6-25	P-2,P-3,P-5	CBT-3M	-	PSTR/L12
CTGPR/L16CA	PAT-32	SM3X0.5X8	CSG-8S	ASM6	SSHM5-16	BHM8-25U	P-2.5,P-4	-	S0816B/S1016B	-

Reference pages: PN PTGN-CA: Inserts → **B087 -**, CBN → **B182 -**, PCD → **B212**
 CP CTGP-CA: Inserts → **B142 -**, CBN → **B199 -**, PCD → **B217 -**

CE CTGE-CA

Clamp-on cartridge, with 90° approach angle, for 20° clearance triangular inserts

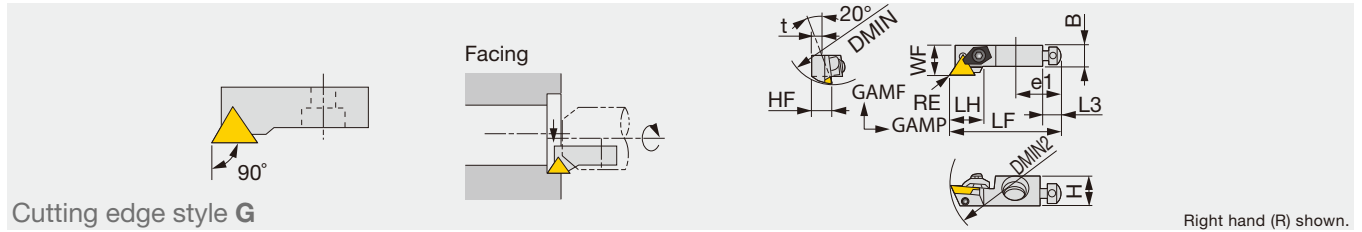

Designation	DMIN	DMIN2	RE**	WF	LF	LH	HF	H	B	e1	L3	GAMF	GAMP	t	Insert
CTGER/L10CA-11	40	55	0.4	14	50	15	10	14.5	10	20	8	5°	10°	5	TE**1103...
CTGER/L12CA-16	50	75	0.8	20	55	20	12	19.5	15	20	8	5°	10°	6	TE**1603...

• **RE: Standard corner radius

SPARE PARTS

Designation	Clamping screw	Axial adjusting screw	Radial adjusting screw	Cartridge setting screw	Wrench	Chipbreaker piece	Sizing plate ass'y (Optional parts)
CTGER/L10CA-11	CSW-40	ASM54	SSHM4-8	CHHM6-15	P-2,P-2.5,P-5	CBT-2M	PSTR/L10
CTGER/L12CA-16	CSW-50	ASM54	SSHM4-14	CHHM6-25	P-2,P-3,P-5	CBT-3M	PSTR/L12

SP STGP-CA

Screw-on cartridge, with 90° approach angle, for 11° clearance triangular inserts

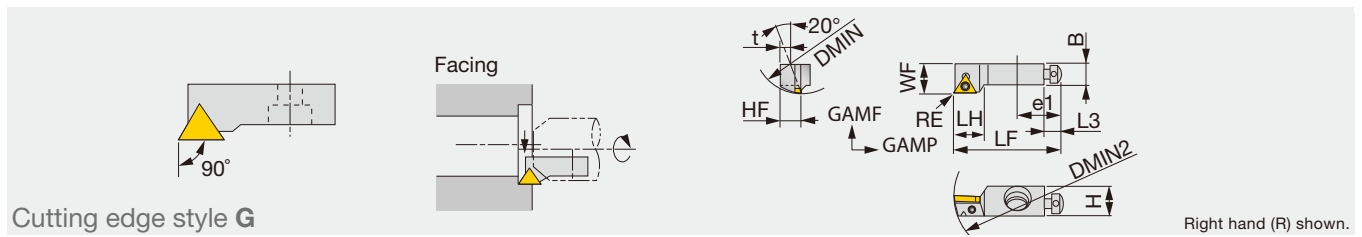

Designation	DMIN	DMIN2	RE**	WF	LF	LH	HF	H	B	e1	L3	GAMF	GAMP	t	Insert
STGPR/L08CA-09	25	35	0.4	10	32	10.9	8	11.5	7.5	17	6	4°	0°	6	TP**0902...
STGPR/L10CA-11	40	55	0.4	14	50	14	10	14.5	10	20	8	4°	0°	8	TP**1102...
STGPL12CA-16	50	75	0.8	20	55	19	12	19.5	15	20	8	5°	2°	8	TP**16T3...

• **RE: Standard corner radius

SPARE PARTS

Designation	Clamping screw	Axial adjusting screw	Radial adjusting screw	Cartridge setting screw	Wrench	Torx wrench	Sizing plate ass'y (Optional parts)
STGPR/L08CA-09	CSTB-2.2S	ASM34L	SSHM3-6	CHHM4-10	P-1.5,P-3	T-7F	PSTR/L08
STGPR/L10CA-11	CSTB-2.5	ASM54	SSHM4-10	CHHM6-15	P-2,P-5	T-8F	PSTR/L10
STGPR/L12CA-16	CSTB-4S	ASM54	SSHM4-14	CHHM6-25	P-2,P-5	T-15F	PSTR/L12

Reference pages: CE CTGE-CA: Inserts → Special

SP STGP-CA: Inserts → **B142 -**, CBN → **B199 -**, PCD → **B217 -**



PN PSKN-CA

Lever-lock cartridge, with 75° approach angle, for negative 90° square inserts

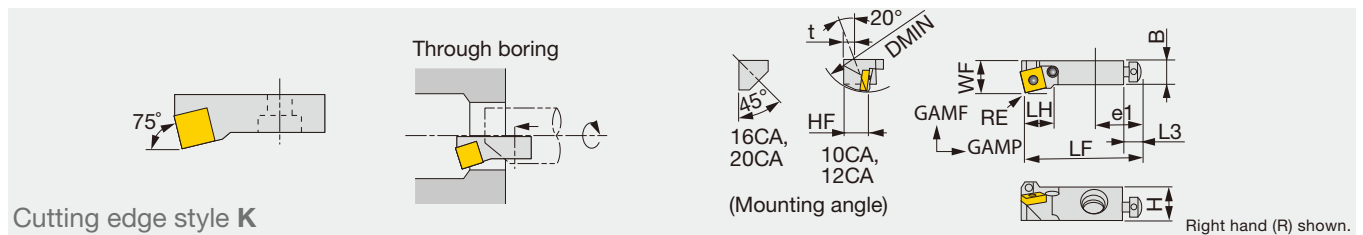

Designation	DMIN	RE**	WF	LF	LH	HF	H	B	e1	L3	GAMF	GAMP	t	Insert
PSKNR10CA-09	40	0.8	14	50	12	10	14.5	10	20	8	-6°	-8°	5	SN**0903...
PSKNR/L12CA-12	50	0.8	20	55	16	12	19.5	15	20	8	-6°	-8°	5	SN**1204...
PSKNR/L16CA	55	0.8	25	63	23	16	16	17	25	8	-6°	-8°	0	SN**1204...
PSKNR20CA	70	1.2	25	70	28	20	20	19	30	10	-6°	-7°	0	SN**1506...

- In above table, DMIN is min. bore dia. for axial mounting.
- When using a right or left hand insert, use right-hand cartridges (R) with left-hand inserts (L); and left-hand cartridges (L) with right-hand inserts (R).
- **RE: Standard corner radius

Designation	Shim	Lever	Cartridge setting screw	Axial adjusting screw	Radial adjusting screw	Cartridge setting screw	Wrench	Shim retainer	Sizing plate (Optional parts)	Sizing plate ass'y (Optional parts)
PSKNR/L10CA-09	-	LCL32N	LCS22	ASM54	SSHM4-4	CHHM6-15	P-2F,P-5	-	-	PSTR/L10
PSKNR/L12CA-12	-	LCL43N	LCS43	ASM54	SSHM4-4	CHHM6-25	P-2,P-2.5,P-5	-	-	PSTR/L12
PSKNR/L16CA	LSS42CA	LCL4	LCS4CA	ASM6	SSHM5-6	BHM8-25U	P-2.5,P-3,P-5	LSP4	S0816B/S1016B	-
PSKNR/L20CA	LSS53CA	LCL5	LCS5CA	ASM6	SSHM5-6	BHM8-30U	P-2.5,P-3,P-5	LSP5	S0820B/S1020B	-

CP CSKP-CA

Clamp-on cartridge, with 75° approach angle, for 11° clearance square inserts

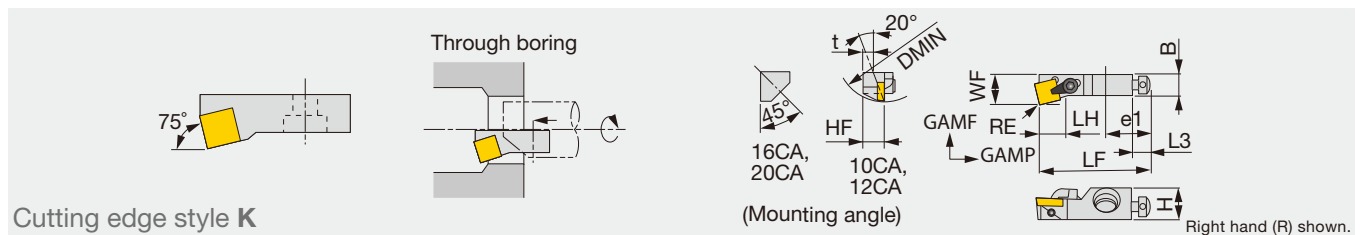

Designation	DMIN	RE**	WF	LF	LH	HF	H	B	e1	L3	GAMF	GAMP	t	Insert
CSKPR/L10CA-09	40	0.8	14	50	12	10	14.5	10	20	8	5°	0°	5	SP**0903...
CSKPR/L12CA-12	50	0.8	20	55	17	12	19.5	15	20	8	5°	2°	6	SP**1203...
CSKPR/L16CA	55	0.8	25	63	22	16	16	17	25	8	5°	0°	0	SP**1203...

- In above table, DMIN is min. bore dia. for axial mounting.
- When using a right or left hand insert, use right-hand cartridges (R) with left-hand inserts (L); and left-hand cartridges (L) with right-hand inserts (R).
- **RE: Standard corner radius

Designation	Shim	Shim screw	Clamping screw	Axial adjusting screw	Radial adjusting screw	Cartridge setting screw	Wrench	Chipbreaker piece	Shim retainer (Optional parts)	Sizing plate ass'y (Optional parts)
CSKPR/L10CA-09	-	-	CSG-5 (CSG-5S)	ASM54	SSHM4-10	CHHM6-15	P-2,P-2.5,P-5	CBS-3M	-	PSTR/L10
CSKPR/L12CA-12	-	-	CSG-6 (CSG-6S)	ASM54	SSHM4-14	CHHM6-25	P-2,P-3,P-5	CBS-4M	-	PSTR/L12
CSKPR/L16CA	PAS-42	SM3X0.5X8	CSG-8S	ASM6	SSHM5-16	BHM8-25U	P-2.5,P-4	-	*	-

Reference pages: PN PSKN-CA: Inserts → **B077 -**, CBN → **B180**, PCD → **B211 -**
 CP CSKP-CA: Inserts → **B135 -**, CBN → **B180 -**, PCD → **B215**

CE CSKE-CA

Clamp-on cartridge, with 75° approach angle, for 20° clearance square inserts

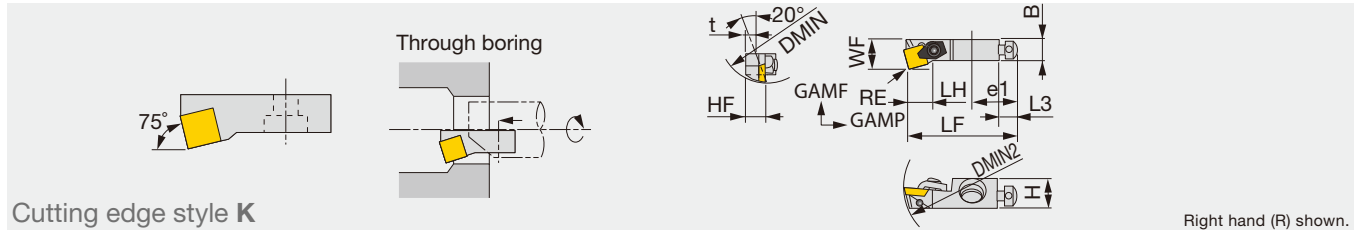

Designation	DMIN	DMIN2	RE**	WF	LF	LH	HF	H	B	e1	L3	GAMF	GAMP	t	Insert
CSKER10CA-09	40	55	0.8	14	50	11.3	10	14.5	10	20	8	10°	5°	8	SE**0903...

- In the above table, DMIN is the minimum bore diameter for axial mounting, and DMIN2 is for radial mounting.
- When using a right or left hand insert, use right-hand cartridges (R) with left-hand inserts (L); and left-hand cartridges (L) with right-hand inserts (R).
- **RE: Standard corner radius

SPARE PARTS

Designation	Cartridge setting screw	Wrench 1	Wrench 2	Wrench 3
CSKER10CA-09	CHHM6-15	P-2	P-2.5	P-5

Designation	Clamping screw	Axial adjusting screw	Radial adjusting screw	Chipbreaker piece	Sizing plate ass'y (Optional parts)
CSKER10CA-09	CSW-40	ASM54	SSHM4-8	CBS-3M	PSTR/L10

SP SSKP-CA

Screw-on cartridge, with 75° approach angle, for 11° clearance square inserts

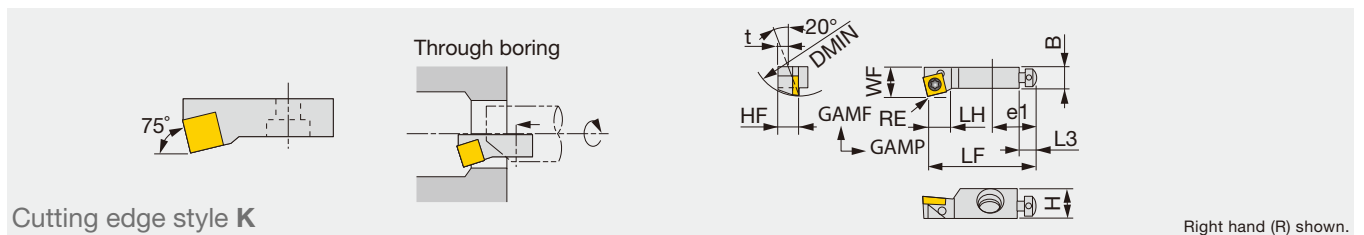

Designation	DMIN	RE**	WF	LF	LH	HF	H	B	e1	L3	GAMF	GAMP	t	Insert
SSKPR10CA-09	40	0.8	14	50	12.7	10	14.5	10	20	8	5°	0°	8	SP**0903...
SSKPR12CA-12	50	0.8	20	55	16	12	19.5	15	20	8	5°	2°	8	SP**1204...

- In above table, DMIN is min. bore dia. for axial mounting.
- When using a right or left hand insert, use right-hand cartridges (R) with left-hand inserts (L); and left-hand cartridges (L) with right-hand inserts (R).
- **RE: Standard corner radius

SPARE PARTS

Designation	Clamping screw	Cartridge setting screw	Wrench 1	Wrench 2	Wrench 3
SSKPR10CA-09	CSTB-4S	CHHM6-15	P-2	T-15F	P-5
SSKPR12CA-12	CSTB-5S	CHHM6-25	P-2	T-20F	P-5

Designation	Axial adjusting screw	Radial adjusting screw	Sizing plate ass'y (Optional parts)
SSKPR10CA-09	ASM54	SSHM4-10	PSTR/L10
SSKPR12CA-12	ASM54	SSHM4-14	PSTR/L12

Reference pages: CE CSKE-CA: Inserts → Special
 SP SSKP-CA: Inserts → **B135 -**, CBN → **B180 -**



PN PCLN-CA

Lever-lock cartridge, with 95° approach angle, for negative 80° rhombic inserts

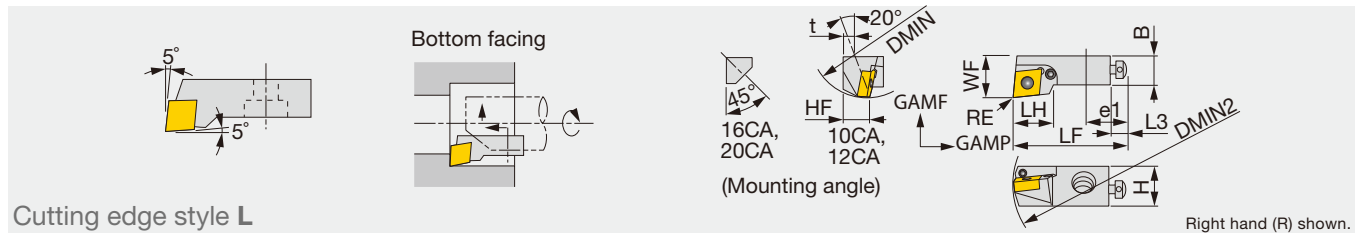

Designation	DMIN	DMIN2	RE**	WF	LF	LH	HF	H	B	e1	L3	GAMF	GAMP	t	Insert
PCLNR/L12CA-12	50	75	0.8	20	55	19	12	19.5	15	20	8	-6°	-8°	6	CN**1204...
PCLNR/L16CA	55	75	0.8	25	63	28	16	16	17	25	8	-6°	-8°	0	CN**1204...
PCLNR/L20CA	70	90	1.2	25	70	31	20	20	19	30	10	-6°	-8°	0	CN**1606...

- In the above table, DMIN is the minimum bore diameter for axial mounting, and DMIN2 is for radial mounting.
- When using a right or left hand insert, use right-hand cartridges (R) with left-hand inserts (L); and left-hand cartridges (L) with right-hand inserts (R).
- **RE: Standard corner radius

SPARE PARTS

Designation	Cartridge setting screw 1	Cartridge setting screw 2	Sizing plate 1	Sizing plate 2	Wrench 1	Wrench 2	Wrench 3
PCLNR/L12CA-12	-	CHHM6-25	-	-	P-2	P-2.5	P-5
PCLNR/L16CA	BHM8-25U	-	S0816B	S1016B	P-2.5	P-3	P-5
PCLNR/L20CA	-	-	-	-	P-2.5	P-3	P-5

Designation	Shim	Lever	Cartridge setting screw	Axial adjusting screw	Radial adjusting screw	Shim retainer	Sizing plate ass'y (Optional parts)
PCLNR/L12CA-12	-	LCL43N	LCS43	ASM54	SSHM4-4	-	PSTR/L12
PCLNR/L16CA	LSC 42CA	LCL4	LCS4CA	ASM6	SSHM5-6	LSP4	-
PCLNR/L20CA	LSC 53CA	LCL5	LCS5CA	ASM6	SSHM5-6	LSP5	-

SP SCLP-CA

Screw-on cartridge, with 95° approach angle, for 11° clearance rhombic inserts

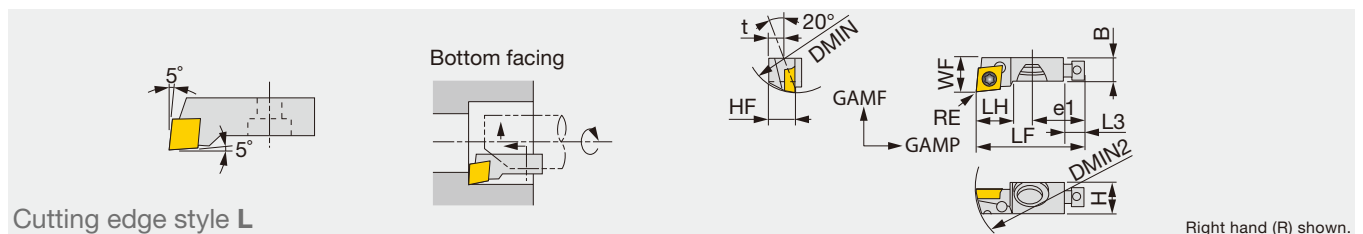

Designation	DMIN	DMIN2	RE**	WF	LF	LH	HF	H	B	e1	L3	GAMF	GAMP	t	Insert
SCLPR/L06CA-05	20	30	0.4	8	25	8.5	6	7.5	5.5	12	4.5	0°	0°	3.5	CP**0502...

- In the above table, DMIN is the minimum bore diameter for axial mounting, and DMIN2 is for radial mounting.
- When using a right or left hand insert, use right-hand cartridges (R) with left-hand inserts (L); and left-hand cartridges (L) with right-hand inserts (R).
- **RE: Standard corner radius

SPARE PARTS

Designation	Clamping screw	Cartridge setting screw	Wrench 1	Wrench 2	Wrench 3
SCLPR/L06CA-05	CSTB-2.2S	CHHM3.5-10	P-1.5	T-7F	P-3

Designation	Axial adjusting screw	Radial adjusting screw	Sizing plate ass'y (Optional parts)
SCLPR/L06CA-05	ASM34S	SSHM3-6	PT06

Reference pages: PN PCLN-CA: Inserts → **B054** -, CBN → **B168** -, PCD → **B211**
 SP SCLP-CA: Inserts → **B118**

CP CTWP-CA

Clamp-on cartridge, with 60° approach angle, for 11° clearance triangular inserts

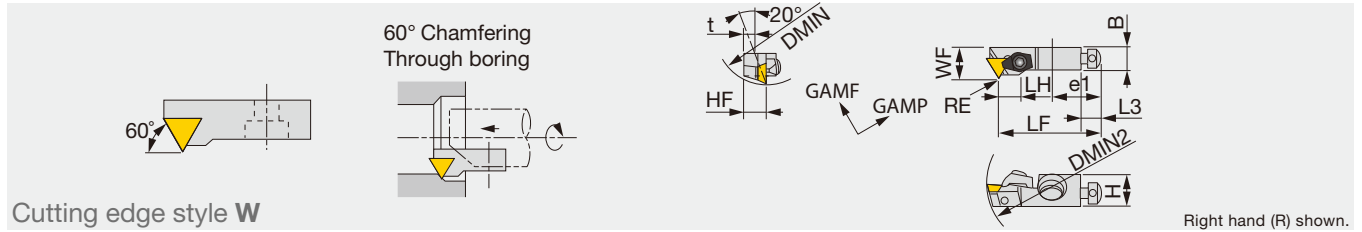

Designation	DMIN	DMIN2	RE**	WF	LF	LH	HF	H	B	e1	L3	GAMF	GAMP	t	Insert
CTWPR10CA-11	40	55	0.4	14	44	13	10	14.5	10	20	8	4°	0°	5	TP**1103...
CTWPR/L12CA-16	50	75	0.8	20	47	11	12	19.5	15	20	8	4°	0°	6	TP**1603...

- In the above table, DMIN is the minimum bore diameter for axial mounting, and DMIN2 is for radial mounting.
- Hand of the insert to be used should be selected depending on the application.
- **RE: Standard corner radius

SPARE PARTS

Designation	Cartridge setting screw	Wrench 1	Wrench 2	Wrench 3
CTWPR10CA-11	CHHM6-15	P-2	P-2.5	P-5
CTWPR/L12CA-16	CHHM6-25	P-2	P-3	P-5

Designation	Clamping screw	Axial adjusting screw	Radial adjusting screw	Chipbreaker piece	Sizing plate ass'y (Optional parts)
CTWPR/L10CA-11	CSG-5 (CSG-5S)	ASM54	SSHM4-10	CBT-2M	PSTR/L10
CTWPR/L12CA-16	CSG-6 (CSG-6S)	ASM54	SSHM4-14	CBT-3M	PSTR/L12

- Cartridges for K-style cutting edge: S0816A or S1016A; S-style cutting edge: S0816C or S1016B
- When not using chipbreaker piece, clamping screw in () should be used.
- Hand of the insert to be used should be selected depending on the application.

SP STWP-CA

Screw-on cartridge, with 60° approach angle, for 11° clearance triangular inserts

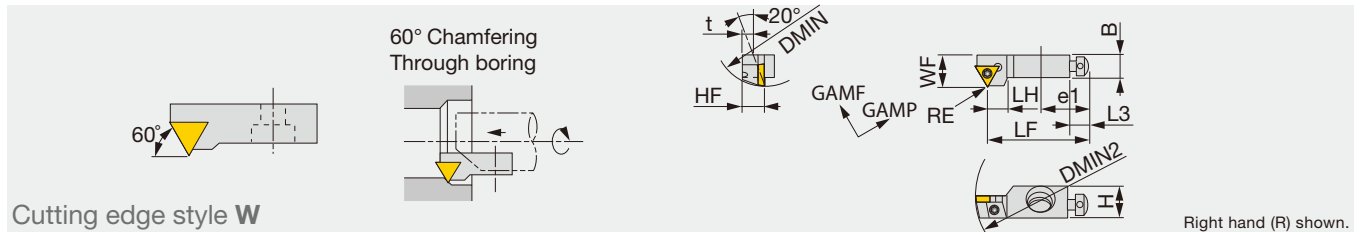

Designation	DMIN	DMIN2	RE**	WF	LF	LH	HF	H	B	e1	L3	GAMF	GAMP	t	Insert
STWPR08CA-09	25	35	0.4	10	28	6	8	11.5	7.5	17	6	4°	0°	6	TP**0902...
STWPR/L10CA-11	40	55	0.4	14	44	9	10	14.5	10	20	8	4°	0°	8	TP**1102...
STWPR12CA-16	50	75	0.8	20	47	9	12	19.5	15	20	8	4°	0°	8	TP**16T3...

- In above table, DMIN is min. bore dia. for axial mounting and DMIN2 is for radial mounting.
- Hand of the insert to be used should be selected depending on the application.
- **RE: Standard corner radius

SPARE PARTS

Designation	Clamping screw	Cartridge setting screw	Wrench 1	Wrench 2	Wrench 3
STWPR08CA-09	CSTB-2.2S	CHHM4-10	P-1.5	T-7F	P-3
STWPR/L10CA-11	CSTB-2.5	CHHM6-15	P-2	T-8F	P-5
STWPR12CA-16	CSTB-4S	CHHM6-25	P-2	T-15F	P-5

Designation	Axial adjusting screw	Radial adjusting screw	Sizing plate ass'y (Optional parts)
STWPR08CA-09	ASM34L	SSHM3-6	PSTR/L08
STWPR/L10CA-11	ASM54	SSHM4-10	PSTR/L10
STWPR12CA-16	ASM54	SSHM4-14	PSTR/L12

Reference pages: CP CTWP-CA, SP STWP-CA: Inserts → **B142 -**, CBN → **B199 -**, PCD → **B217 -**



PN PSSN-CA

Lever-lock cartridge, with 45° approach angle, for negative 90° square inserts

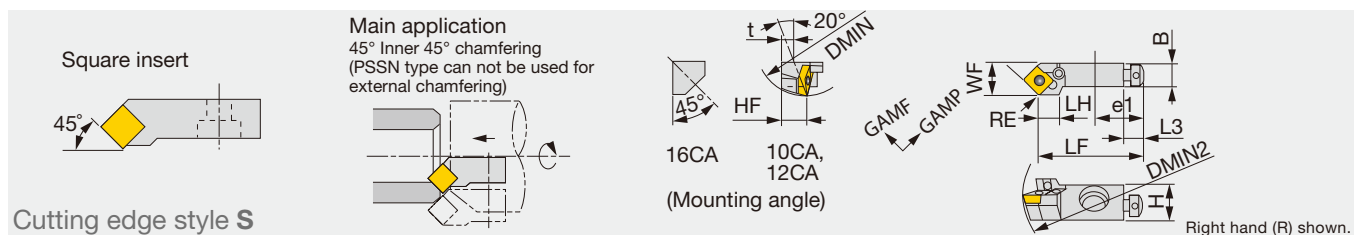

Cutting edge style **S**

Designation	DMIN	DMIN2	RE**	WF	LF	LH	HF	H	B	e1	L3	GAMF	GAMP	t	Insert
PSSNR/L10CA-09	40	55	0.8	14	44	10	10	14.5	10	20	8	-12°	0°	5	SN**0903...
PSSNR/L12CA-12	50	75	0.8	20	47	12	12	19.5	15	20	8	-12°	0°	6	SN**1204...
PSSNR/L16CA	55	75	0.8	25	53	28	16	16	17	25	8	-11°	0°	0	SN**1204...

- In the above table, DMIN is the minimum bore diameter for axial mounting, and DMIN2 is for radial mounting.
- Hand of the insert to be used should be selected depending on the application.
- **RE: Standard corner radius

SPARE PARTS

Designation	Cartridge setting screw 1	Cartridge setting screw 2	Wrench 1	Wrench 2	Wrench 3	Radial adjusting screw
PSSNR/L10CA-09	-	CHHM4-4	P-5	P-2F	-	SSHM4-4
PSSNR/L12CA-12	-	CHHM6-25	P-2	P-2.5	P-5	SSHM4-4
PSSNR/L16CA	BHM8-25U	CHHM6-25	P-2.5	P-3	P-5	SSHM5-6

Designation	Shim	Lever	Cartridge setting screw	Axial adjusting screw	Shim retainer	Sizing plate (Optional parts)	Sizing plate ass'y (Optional parts)
PSSNR/L10CA-09	-	LCL32N	LCS22	ASM54	-	-	PSTR/L10
PSSNR/L12CA-12	-	LCL43N	LCS43	ASM54	-	-	PSTR/L12
PSSNR/L16CA	LSS42CA	LCL4	LCS4CA	ASM6	LSP4	S0816B/S1016B	-

- Cartridges for K-style cutting edge: S0816A or S1016A; S-style cutting edge: S0816C or S1016B

Reference pages: PN PSSN-CA: Inserts → **B077 -**, CBN → **B180 -**, PCD → **B211 -**

CP CSSP-CA

Clamp-on cartridge, with 45° approach angle, for 11° clearance square inserts

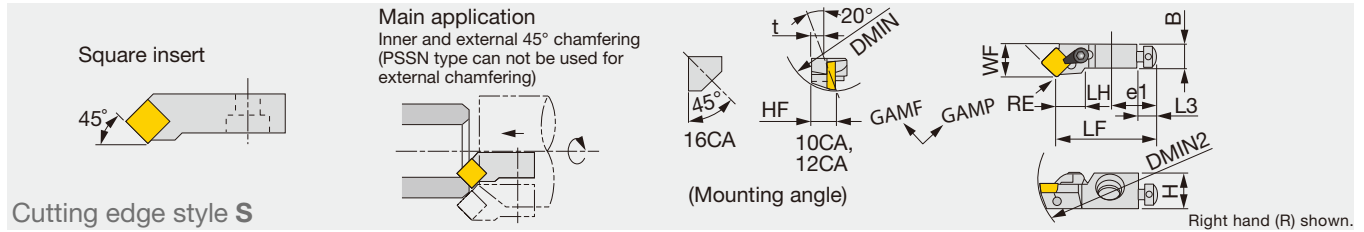

Designation	DMIN	DMIN2	RE**	WF	LF	LH	HF	H	B	e1	L3	GAMF	GAMP	t	Insert
CSSPR/L10CA-09	40	55	0.8	14	44	11	10	14.5	10	20	8	3°	0°	5	SP**0903...
CSSPR/L12CA-12	50	75	0.8	20	47	13	12	19.5	15	20	8	4°	0°	6	SP**1203...
CSSPR16CA	55	75	0.8	25	53	15	16	16	17	25	8	0°	0°	0	SP**1203...

- In the above table, DMIN is the minimum bore diameter for axial mounting, and DMIN2 is for radial mounting.
- Hand of the insert to be used should be selected depending on the application.
- **RE: Standard corner radius

SPARE PARTS

Designation	Cartridge setting screw 1	Cartridge setting screw 2	Wrench 1	Wrench 2	Wrench 3	Radial adjusting screw
CSSPR/L10CA-09	-	CHHM6-15	P-2	P-2.5	P-5	SSHM4-10
CSSPR/L12CA-12	-	CHHM6-25	P-2	P-3	P-5	SSHM4-14
CSSPR16CA	BHM8-25U	-	P-2.5	P-4	-	SSHM5-16

Designation	Shim	Shim screw	Clamping screw	Axial adjusting screw	Radial adjusting screw	Chipbreaker piece	Sizing plate ass'y (Optional parts)
CSSPR/L10CA-09	-	-	CSG-5 (CSG-5S)	ASM54	SSHM4-10	CBS-3M	PSTR/L10
CSSPR/L12CA-12	-	-	CSG-6 (CSG-6S)	ASM54	SSHM4-14	CBS-4M	PSTR/L12
CSSPR16CA	PAS-42	SM3X0.5X8	CSG-8S	ASM6	SSHM5-16	-	-

- Cartridges for K-style cutting edge: S0816A or S1016A; S-style cutting edge: S0816C or S1016B
- When not using chipbreaker piece, clamping screw in () should be used.

CE CSSE-CA

Clamp-on cartridge, with 45° approach angle, for 20° clearance square inserts

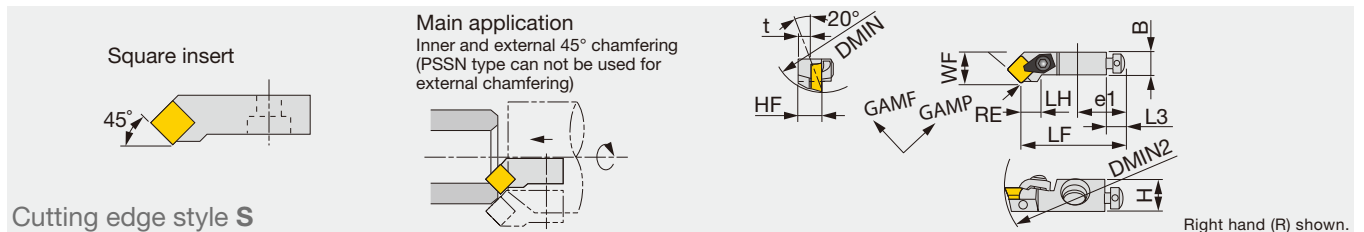

Designation	DMIN	DMIN2	RE**	WF	LF	LH	HF	H	B	e1	L3	GAMF	GAMP	t	Insert
CSSER12CA-12	50	75	0.8	20	47	12	12	19.5	15	20	8	10°	0°	6	SE**1203...

- In the above table, DMIN is the minimum bore diameter for axial mounting, and DMIN2 is for radial mounting.
- Hand of the insert to be used should be selected depending on the application.
- **RE: Standard corner radius

SPARE PARTS

Designation	Cartridge setting screw	Wrench 1	Wrench 2	Wrench 3
CSSER12CA-12	CHHM6-25	P-2	P-3	P-5

Designation	Clamping screw	Axial adjusting screw	Radial adjusting screw	Chipbreaker piece	Sizing plate ass'y (Optional parts)
CSSER12CA-12	CSW-50	ASM54	SSHM4-14	CBS-4M	PSTR/L12

Reference pages: CP CSSP-CA: Inserts → **B135 -**, CBN → **B180 -**, PCD → **B215**
CE CSSE-CA: Inserts → Special

SP SSSP-CA

Screw-on cartridge, with 45° approach angle, for 11° clearance square inserts

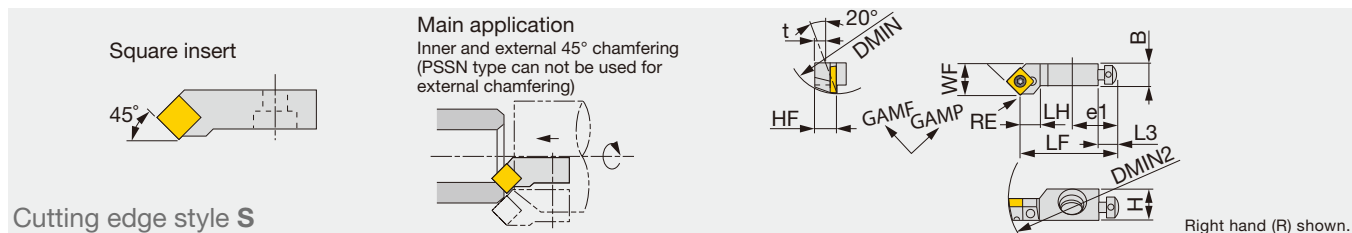

Cutting edge style **S**

Designation	DMIN	DMIN2	RE**	WF	LF	LH	HF	H	B	e1	L3	GAMF	GAMP	t	Insert
SSSPR/L10CA-09	40	55	0.8	14	44	9	10	14.5	10	20	8	3°	0°	8	SP**0903...
SSSPR/L12CA-12	50	75	0.8	20	47	13	12	19.5	15	20	8	4°	0°	8	SP**1204...

- In the above table, DMIN is the minimum bore diameter for axial mounting, and DMIN2 is for radial mounting.
- Hand of the insert to be used should be selected depending on the application.
- **RE: Standard corner radius

SPARE PARTS

Designation	Clamping screw	Cartridge setting screw	Wrench 1	Wrench 2	Wrench 3
SSSPR/L10CA-09	CSTB-4S	CHHM6-15	P-2	T-15F	P-5
SSSPR/L12CA-12	CSTB-5S	CHHM6-25	P-2	T-20F	P-5

Designation	Axial adjusting screw	Radial adjusting screw	Sizing plate ass'y (Optional parts)
SSSPR/L10CA-09	ASM54	SSHM4-10	PSTR/L10
SSSPR/L12CA-12	ASM54	SSHM4-14	PSTR/L12

CP CTSP-CA

Clamp-on cartridge, with 45° approach angle, for 11° clearance triangular inserts

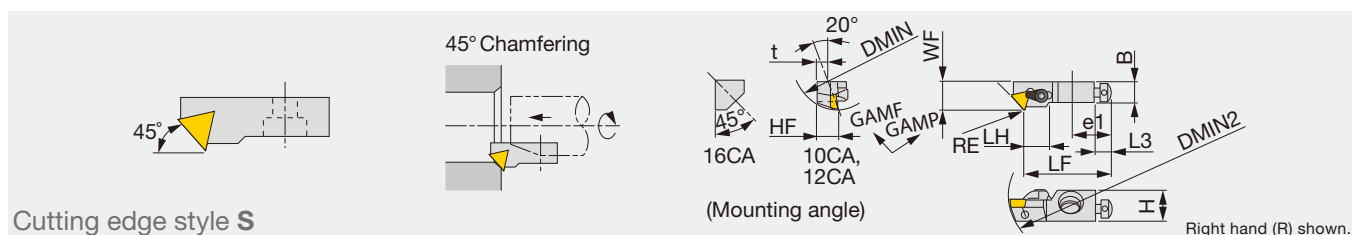

Cutting edge style **S**

Designation	DMIN	DMIN2	RE**	WF	LF	LH	HF	H	B	e1	L3	GAMF	GAMP	t	Insert
CTSPR/L10CA-11	40	55	0.4	14	44	12	10	14.5	10	20	8	3°	0°	5	TP**1103...
CTSPR/L12CA-16	50	75	0.8	20	47	11	12	19.5	15	20	8	4°	0°	6	TP**1603...

- In the above table, DMIN is the minimum bore diameter for axial mounting, and DMIN2 is for radial mounting.
- When using a right or left hand insert, use right-hand cartridges (R) with left-hand inserts (L); and left-hand cartridges (L) with right-hand inserts (R).
- **RE: Standard corner radius

SPARE PARTS

Designation	Cartridge setting screw	Wrench 1	Wrench 2	Wrench 3
CTSPR/L10CA-11	CHHM6-15	P-2	P-2.5	P-5
CTSPR/L12CA-16	CHHM6-25	P-2	P-3	P-5

Designation	Clamping screw	Axial adjusting screw	Radial adjusting screw	Chipbreaker piece	Sizing plate ass'y (Optional parts)
CTSPR/L10CA-11	CSG-5 (CSG-5S)	ASM54	SSHM4-10	CBT-2M	PSTR/L10
CTSPR/L12CA-16	CSG-6 (CSG-6S)	ASM54	SSHM4-14	CBT-3M	PSTR/L12

- Cartridges for K-style cutting edge: S0816A or S1016A; S-style cutting edge: S0816C or S1016B
- When not using chipbreaker piece, clamping screw in () should be used.

Reference pages: SP SSSP-CA: Inserts → **B135 -**, CBN → **B180 -**, PCD → **B215**
 CP CTSP-CA: Inserts → **B142 -**, CBN → **B199 -**, PCD → **B217 -**

CE CTSE-CA

Clamp-on cartridge, with 45° approach angle, for 20° clearance triangular inserts

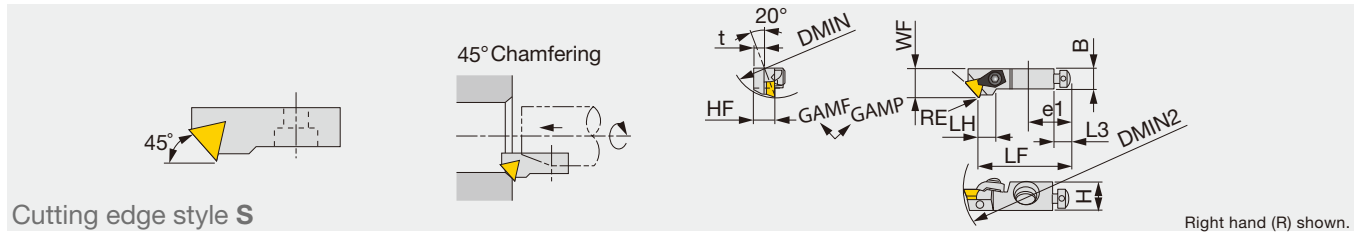

Designation	DMIN	DMIN2	RE**	WF	LF	LH	HF	H	B	e1	L3	GAMF	GAMP	t	Insert
CTSER10CA-11	40	55	0.4	14	44	8	10	14.5	10	20	8	10°	0°	5	TE**1103...

- In the above table, DMIN is the minimum bore diameter for axial mounting, and DMIN2 is for radial mounting.
- When using a right or left hand insert, use right-hand cartridges (R) with left-hand inserts (L); and left-hand cartridges (L) with right-hand inserts (R).
- **RE: Standard corner radius

SPARE PARTS

Designation	Cartridge setting screw	Wrench 1	Wrench 2	Wrench 3
CTSER10CA-11	CHHM6-15	P-2	P-2.5	P-5

Designation	Clamping screw	Axial adjusting screw	Radial adjusting screw	Chipbreaker piece	Sizing plate ass'y (Optional parts)
CTSER10CA-11	CSW-40	ASM54	SSHM4-8	CBT-2M	PSTR/L10

SP STSP-CA / SCSP-CA

Screw-on cartridge, with 45° approach angle, for 11° clearance triangular inserts and rhombic inserts

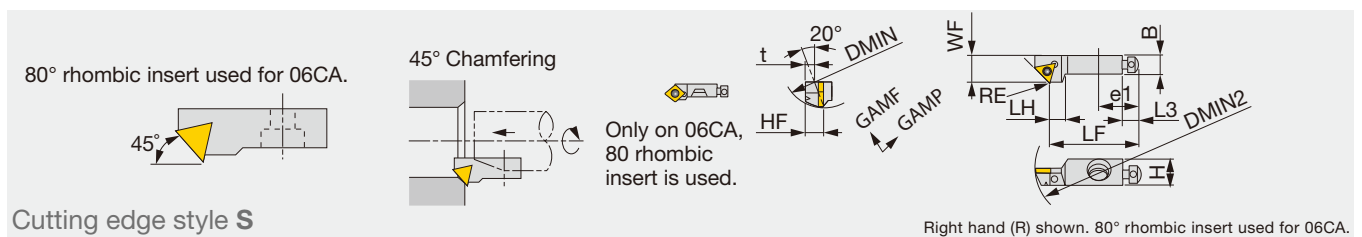

Designation	DMIN	DMIN2	RE**	WF	LF	LH	HF	H	B	e1	L3	GAMF	GAMP	t	Insert
SCSPR/L06CA-05	20	30	0.4	8	22	6	6	7.5	5.5	12	4.5	0°	0°	3.5	CP**0502...
STSPR/L08CA-09	25	35	0.4	10	28	5.2	8	11.5	7.5	17	6	0°	0°	4.5	TP**0902...
STSPR/L10CA-11	40	55	0.4	14	44	9	10	14.5	10	20	8	3°	0°	5	TP**1102...
STSPR/L12CA-16	50	75	0.8	20	47	11	12	19.5	15	20	8	4°	0°	6	TP**16T3...

- In the above table, DMIN is the minimum bore diameter for axial mounting, and DMIN2 is for radial mounting.
- When using a right or left hand insert, use right-hand cartridges (R) with left-hand inserts (L); and left-hand cartridges (L) with right-hand inserts (R).
- **RE: Standard corner radius

SPARE PARTS

Designation	Clamping screw	Cartridge setting screw	Wrench 1	Wrench 2	Wrench 3
SCSPR/L06CA-05	CSTB-2.2S	CHHM3.5-10	P-1.5	T-7F	P-3
STSPR/L08CA-09	CSTB-2.2S	CHHM4-10	P-1.5	T-7F	P-3
STSPR/L10CA-11	CSTB-2.5	CHHM6-15	P-2	T-8F	P-5
STSPR/L12CA-16	CSTB-4S	CHHM6-25	P-2	T-15F	P-5

Designation	Axial adjusting screw	Radial adjusting screw	Sizing plate ass'y (Optional parts)
SCSPR/L06CA-05	ASM34S	SSHM3-6	PT06
STSPR/L08CA-09	ASM34L	SSHM3-6	PSTR/L08
STSPR/L10CA-11	ASM54	SSHM4-10	PSTR/L10
STSPR/L12CA-16	ASM54	SSHM4-14	PSTR/L12

Reference pages: CE CTSE-CA: Inserts → Special
 SP STSP-CA / SCSP-CA: Inserts → **B118** (CP**), **B142** - (TP**),
 CBN → **B199** -, PCD → **B217** -

PN PTTN-CA

Lever-lock cartridge, with 30° approach angle, for negative 60° triangular inserts

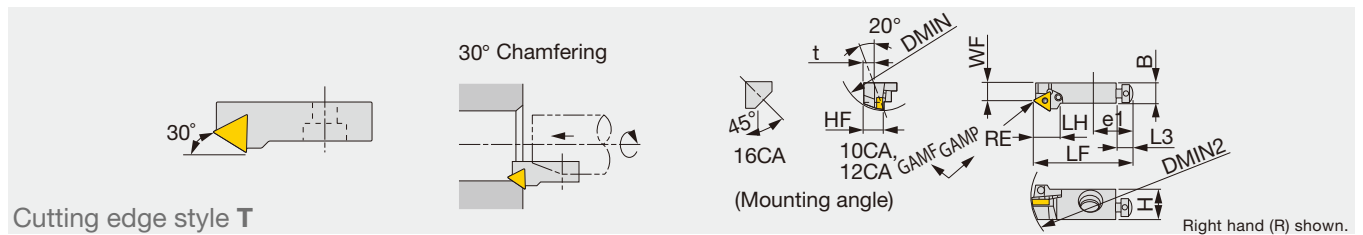

Designation	DMIN	DMIN2	RE**	WF	LF	LH	HF	H	B	e1	L3	GAMF	GAMP	t	Insert
PTTNR/L10CA-11	40	55	0.4	9	50	13	10	14.5	10	20	8	-10°	0°	5	TN**1103...
PTTNR/L12CA-16	50	75	0.8	13	55	19	12	19.5	15	20	8	-10°	0°	6	TN**1604...
PTTNR/L16CA	60	75	0.8	15	63	22	16	16	17	25	8	-10°	-2°	0	TN**1604...

- In the above table, DMIN is the minimum bore diameter for axial mounting, and DMIN2 is for radial mounting.
- When using a right or left hand insert, use right-hand cartridges (R) with left-hand inserts (L); and left-hand cartridges (L) with right-hand inserts (R).
- **RE: Standard corner radius

SPARE PARTS

Designation	Cartridge setting screw	Sizing plate 1	Sizing plate 2	Wrench 1	Wrench 2
PTTNR/L10CA-11	CHHM6-15	-	-	P-5	P-2F
PTTNR/L12CA-16	CHHM6-25	-	-	P-5	P-2F
PTTNR/L16CA	BHM8-25U	S0816B	S1016B	P-2.5	P-5

Designation	Shim	Lever	Cartridge setting screw	Axial adjusting screw	Radial adjusting screw	Shim retainer	Sizing plate ass'y (Optional parts)
PTTNR/L10CA-11	-	LCL22N	LCS22	ASM54	SSHM4-4	-	PSTR/L10
PTTNR/L12CA-16	-	LCL33N	LCS33	ASM54	SSHM4-4	-	PSTR/L12
PTTNR/L16CA	LST317CA	LCL3	LCS3	ASM6	SSHM5-6	LSP3	-

CP CTPP-CA

Clamp-on cartridge, with 30° approach angle, for 11° clearance triangular inserts

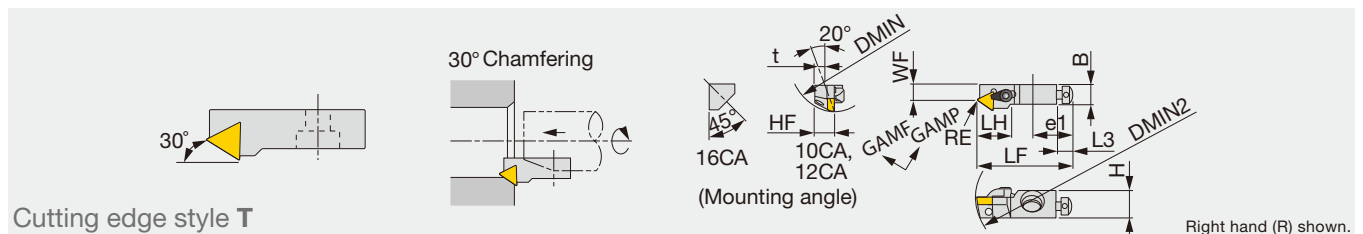

Designation	DMIN	DMIN2	RE**	WF	LF	LH	HF	H	B	e1	L3	GAMF	GAMP	t	Insert
CTTPR/L10CA-11	40	55	0.4	9	50	18	10	14.5	10	20	8	0°	0°	5	TP**1103...
CTTPR/L12CA-16	50	75	0.8	13	55	22	12	19.5	15	20	8	4°	0°	6	TP**1603...
CTTPL16CA	55	75	0.8	15	63	23	16	16	17	25	8	0°	0°	0	TP**1603...

- In the above table, DMIN is the minimum bore diameter for axial mounting, and DMIN2 is for radial mounting.
- When using a right or left hand insert, use right-hand cartridges (R) with left-hand inserts (L); and left-hand cartridges (L) with right-hand inserts (R).
- **RE: Standard corner radius

SPARE PARTS

Designation	Cartridge setting screw	Sizing plate 1	Sizing plate 2	Wrench 1	Wrench 2	Wrench 3
CTTPL10CA-11	CHHM6-15	-	-	P-2	P-2.5	P-5
CTTPR/L12CA-16	CHHM6-25	-	-	P-2	P-3	P-5
CTTPL16CA	BHM8-25U	S0816B	S1016B	P-2.5	P-4	-

Designation	Shim	Shim screw	Clamping screw	Axial adjusting screw	Radial adjusting screw	Sizing plate ass'y (Optional parts)	Chipbreaker piece
CTTPR/L10CA-11	-	-	CSG-5 (CSG-5S)	ASM54	SSHM4-10	PSTR/L10	CBT-2M
CTTPR/L12CA-16	-	-	CSG-6 (CSG-6S)	ASM54	SSHM4-14	PSTR/L12	CBT-3M
CTTPL10CA	PAT-32	SM3X0.5X8	CSG-8S	ASM6	SSHM5-16	-	-

Reference pages: PN PTTN-CA: Inserts → **B087 -**, CBN → **B182 -**, PCD → **B212**
 CP CTPP-CA: Inserts → **B142 -**, CBN → **B199 -**, PCD → **B217 -**

CE CTTE-CA

Clamp-on cartridge, with 30° approach angle, for 20° clearance triangular inserts

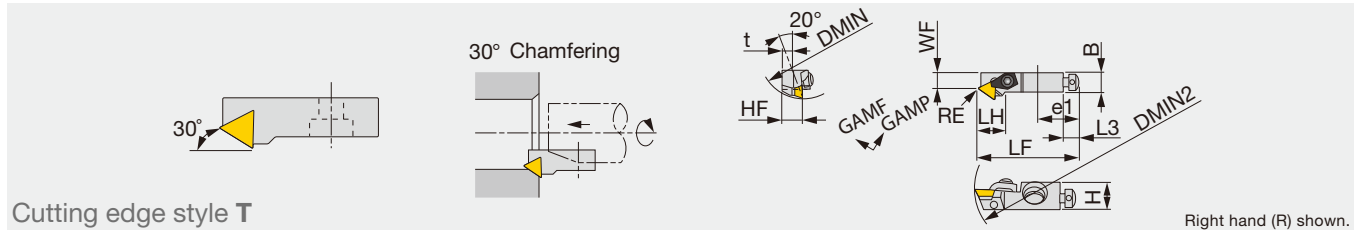

Cutting edge style T

Designation	DMIN	DMIN2	RE**	WF	LF	LH	HF	H	B	e1	L3	GAMF	GAMP	t	Insert
CTTER10CA-11	40	55	0.4	9	50	14	10	14.5	10	20	8	10°	0°	5	TE**1103...
CTTER12CA-16	50	75	0.8	13	55	18	12	19.5	15	20	8	10°	0°	6	TE**1603...

- In the above table, DMIN is the minimum bore diameter for axial mounting, and DMIN2 is for radial mounting.
- When using a right or left hand insert, use right-hand cartridges (R) with left-hand inserts (L); and left-hand cartridges (L) with right-hand inserts (R).
- **RE: Standard corner radius

SPARE PARTS

Designation	Cartridge setting screw	Wrench 1	Wrench 2	Wrench 3
CTTER10CA-11	CHHM6-15	P-2	P-2.5	P-5
CTTER12CA-16	CHHM6-25	P-2	P-3	P-5

Designation	Clamping screw	Axial adjusting screw	Radial adjusting screw	Chipbreaker piece	Sizing plate ass'y (Optional parts)
CTTER10CA-11	CSW-40	ASM54	SSHM4-8	CBT-2M	PSTR10
CTTER12CA-16	CSW-50	ASM54	SSHM4-14	CBT-3M	PSTR12

SP STTP-CA / SCTP-CA

Screw-on cartridge, with 30° approach angle, for 11° clearance triangular inserts and rhombic inserts

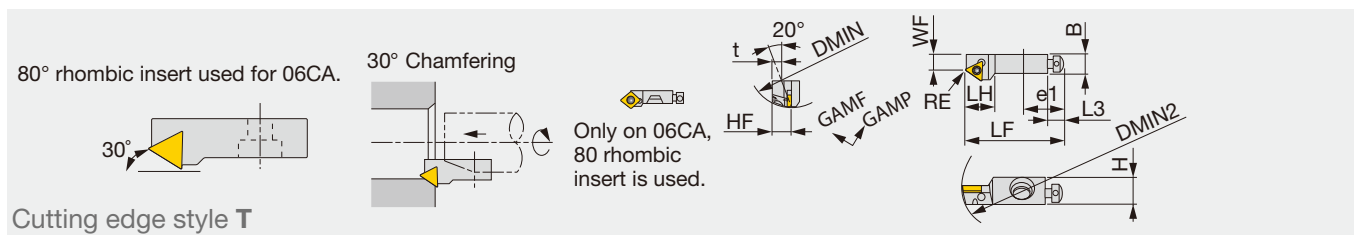

Cutting edge style T

Designation	DMIN	DMIN2	RE**	WF	LF	LH	HF	H	B	e1	L3	GAMF	GAMP	t	Insert
SCTPR06CA-05	20	30	0.4	5.4	25	9	6	7.5	5.5	12	4.5	0°	0°	3.5	CP**0502...
STTPR/L08CA-09	25	35	0.4	6	32	10	8	11.5	7.5	17	6	0°	0°	4.5	TP**0902...
STTPR10CA-11	40	55	0.4	9	50	15	10	14.5	10	20	8	0°	0°	5	TP**1102...

Designation	Clamping screw	Axial adjusting screw	Radial adjusting screw	Cartridge setting screw	Wrench	Torx wrench	Sizing plate ass'y (Optional parts)
SCTPR/L06CA-05	CSTB-2.2S	ASM34S	SSHM3-6	CHHM3.5-10	P-1.5,P-3	T-7F	PT06
STTPR/L08CA-09	CSTB-2.2S	ASM34L	SSHM3-6	CHHM4-10	P-1.5,P-3	T-7F	PSTR/L08
STTPR/L10CA-11	CSTB-2.5	ASM54	SSHM4-10	CHHM6-15	P-2,P-5	T-8F	PSTR/L10

Reference pages: CE CTTE-CA: Inserts → Special

SP STTP-CA / SCTP-CA: Inserts → **B118** (CP**), **B142** - (TP**),
CBN → **B199** -, PCD → **B217** -



PN PSYN-CA

Lever-lock cartridge, with 85° approach angle, for negative 90° square inserts

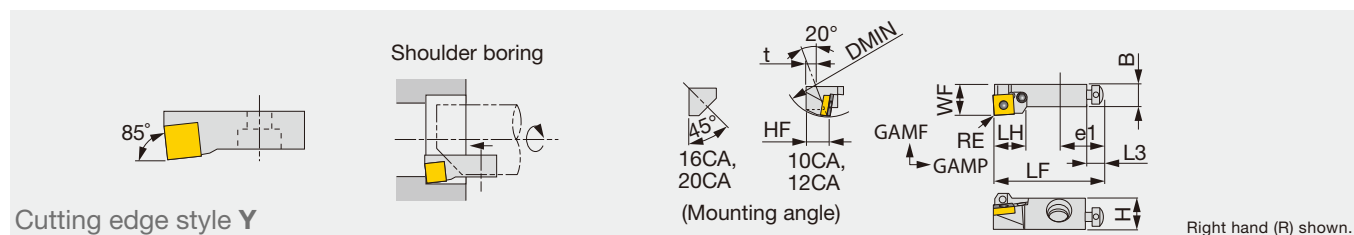

Designation	DMIN	RE**	WF	LF	LH	HF	H	B	e1	L3	GAMF	GAMP	t	Insert
PSYNR10CA-09	40	0.8	14	50	14	10	14.5	10	20	8	-6°	-8°	5	SN**0903...
PSYNR12CA-12	50	0.8	20	55	18	12	19.5	15	20	8	-6°	-8°	6	SN**1204...
PSYNR16CA	55	0.8	25	63	26	16	16	17	25	8	-6°	-8°	0	SN**1204...
PSYNR20CA	70	1.2	25	70	30	20	20	19	30	10	-6°	-7°	0	SN**1506...

- In above table, DMIN is min. bore dia. for axial mounting.
- When using a right or left hand insert, use right-hand cartridges (R) with left-hand inserts (L); and left-hand cartridges (L) with right-hand inserts (R).
- **RE: Standard corner radius

Designation	Shim	Lever	Shim screw	Axial adjusting screw	Radial adjusting screw	Cartridge setting screw	Wrench	Shim retainer	Sizing plate	Sizing plate ass'y (Optional parts)
PSYNR10CA-09	-	LCL32N	LCS22	ASM54	SSHM4-4	CHHM4-4	P-2F,P-5	-	-	PSTR/L10
PSYNR12CA-12	-	LCL43N	LCS43	ASM54	SSHM4-4	CHHM6-25	P-2,P-2.5,P-5	-	-	PSTR/L12
PSYNR16CA	LSS42CA	LCL4	LCS4CA	ASM6	SSHM5-6	BHM8-25U	P-2.5,P-3,P-5	LSP4	S0816B/S1016B	-
PSYNR20CA	LSS53CA	LCL5	LCS5CA	ASM6	SSHM5-6	BHM8-30U	P-2.5,P-3,P-5	LSP5	S0820B/S1020B	-

CP CSYP-CA

Clamp-on cartridge, with 85° approach angle, for 11° clearance square inserts

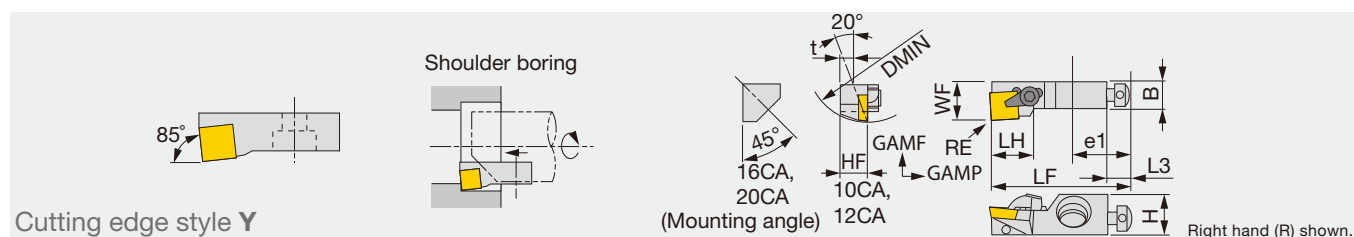

Designation	DMIN	RE**	WF	LF	LH	HF	H	B	e1	L3	GAMF	GAMP	t	Insert
CSYPR/L10CA-09	40	0.8	14	50	15	10	14.5	10	20	8	5°	0°	5	SP**0903...
CSYPR12CA-12	50	0.8	20	55	19	12	19.5	15	20	8	5°	2°	6	SP**1203...
CSYPR16CA	55	0.8	25	63	23	16	16	17	25	8	5°	0°	0	SP**1203...

- In above table, DMIN is min. bore dia. for axial mounting.
- When using a right or left hand insert, use right-hand cartridges (R) with left-hand inserts (L); and left-hand cartridges (L) with right-hand inserts (R).

Designation	Cartridge setting screw	Sizing plate 1	Sizing plate 2	Wrench 1	Wrench 2	Wrench 3
CSYPR/L10CA-09	CHHM6-15	-	-	P-2	P-2.5	P-5
CSYPR12CA-12	CHHM6-25	-	-	P-2	P-3	P-5
CSYPR16CA	BHM8-25U	-	-	P-2.5	P-4	-

Designation	Shim	Shim screw	Clamping screw	Axial adjusting screw	Radial adjusting screw	Chipbreaker piece	Sizing plate ass'y (Optional parts)
CSYPR/L10CA-09	-	-	CSG-5 (CSG-5S)	ASM54	SSHM4-10	CBS-3M	PSTR/L10
CSYPR12CA-12	-	-	CSG-6 (CSG-6S)	ASM54	SSHM4-14	CBS-4M	PSTR/L12
CSYPR16CA	PAS-42	SM3X0.5X8	CSG-8S	ASM6	SSHM5-16	-	-

- Cartridges for K-style cutting edge: S0816A or S1016A; S-style cutting edge: S0816C or S1016B
- When not using chipbreaker piece, clamping screw in () should be used.

Reference pages: PN PSYN-CA: Inserts → **B077 -**, CBN → **B180 -**, PCD → **B211 -**
 CP CSYP-CA: Inserts → **B135 -**, CBN → **B180 -**, PCD → **B215**

SP SSYP-CA

Screw-on cartridge, with 85° approach angle, for 11° clearance square inserts

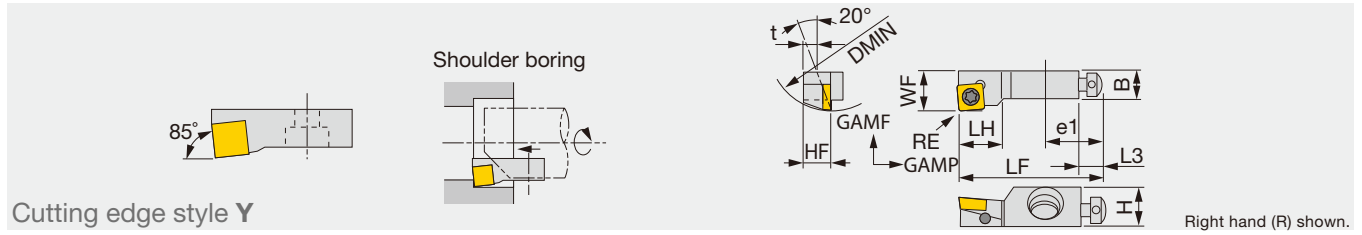

Cutting edge style Y

Designation	DMIN	RE**	WF	LF	LH	HF	H	B	e1	L3	GAMF	GAMP	t	Insert
SSYPR10CA-09	40	0.8	14	50	15	10	14.5	10	20	8	5°	0°	5	SP**0903...

- In above table, DMIN is min. bore dia. for axial mounting.
- **RE: Standard corner radius

SPARE PARTS

Designation	Clamping screw	Wrench 1	Wrench 2	Wrench 3
SSYPR10CA-09	CSTB-4S	P-2	T-15F	P-5

Designation	Axial adjusting screw	Radial adjusting screw	Cartridge setting screw	Sizing plate ass'y (Optional parts)
SSYPR10CA-09	ASM54	SSHM4-10	CHHM6-15	PSTR/L10

Grade
Insert
Ext. Toolholder
Int. Toolholder
Threading
Grooving
Miniature tool
Milling cutter
Endmill
Drilling tool
Tooling System
User's Guide
Index

A
B
C
D
E
F
G
H
I
J
K
L
M

A-type (Positive rake, compact type)

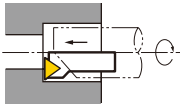
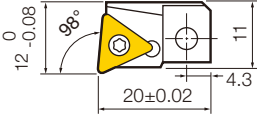
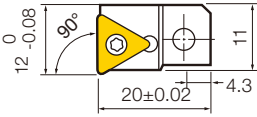
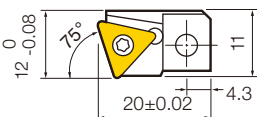
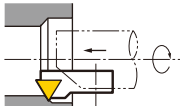
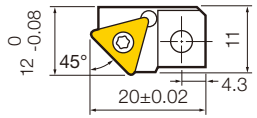
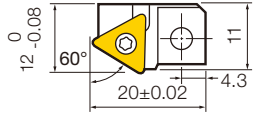
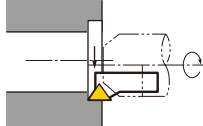
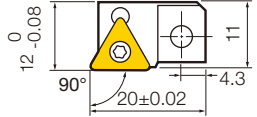
Application		Shape	Designation	Specification
Boring			ATX-0 R/L	<ul style="list-style-type: none"> ● Applicable inserts TP□□1103□□ (With Tungaloy's standard hole) B142 -, B199 - ● Min. bore diameter ø32 ● Cutting edge height 9 mm ● Dimension for mounting
			ATF-0 R/L	
			ATK-0 R/L	
Chamfering			ATS-0 R/L	
			ATT-0 R/L	
Facing			ATG-0 L	

Note: Right hand (R) shown.

SPARE PARTS

Designation	Mounting screw	Adjusting screw (axial direction)	Insert clamping screw	Shim sheet	Wrench
For all products	M4×15	M3×0.5×8	CSTA-NO2L	SM-00	P-1.5, T-8F

Boring bar tool

TBS1

Square shank, with 90° approach angle, screw-on type

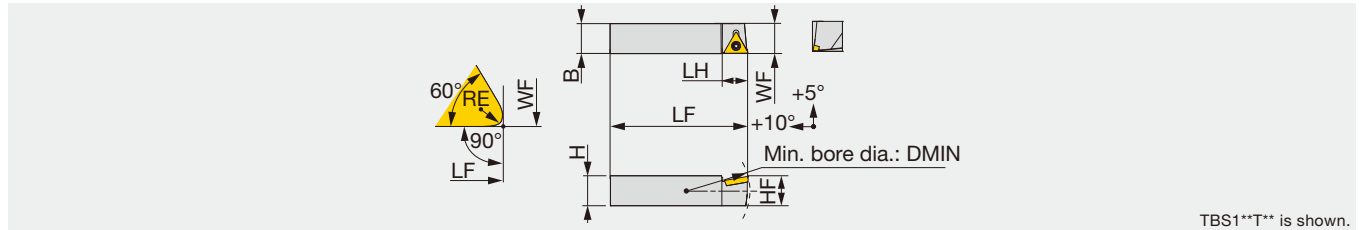

Designation	DMIN	WF	HF	LH	B	H	LF	RE**	Insert
TBS108T08	25	7.8	7.8	9	8	8	40	0.4	TP**0802...
TBS110T09	38	9.8	9.8	10	10	10	50	0.4	TP**0902...
TBS113T11	50	12.8	12.8	12	13	13	60	0.4	TP**1102...
TBS116C12	62	15.8	15.8	18	16	16	80	0.8	CP**1204...
TBS119C12	72	18.8	18.8	18	19	19	95	0.8	CP**1204...
TBS125C16	82	24.8	24.8	22	25	25	125	1.2	CP**1605...

- Figures shown above are of 13 mm or smaller square shanks used for normal direction of rotation.
- For the tools used for reverse direction of rotation, add H in the end of the designation. (Example: TBS308T08H)
- Use left-hand inserts (L) for normal direction of rotation, and right-hand inserts (R) for reverse direction of rotation.

SPARE PARTS

Designation	Clamping screw	Shim screw	Shim	Wrench 1	Wrench 2
TBS108T08	CSTB-2L	-	-	-	T-6F
TBS110T09	CSTB-2.2	-	-	-	T-7F
TBS113T11	CSTB-2.5	-	-	-	T-8F
TBS116C12	CSTB-5	-	-	-	T-20F
TBS119C12	CSTB-4F	DTS6-4	SSC4T3-P	P-4	T-15F
TBS125C16	CSTB-4F	DTS6-4	SSC54-P	P-4	T-15F

TBS3

Square shank, with 30° approach angle, screw-on type

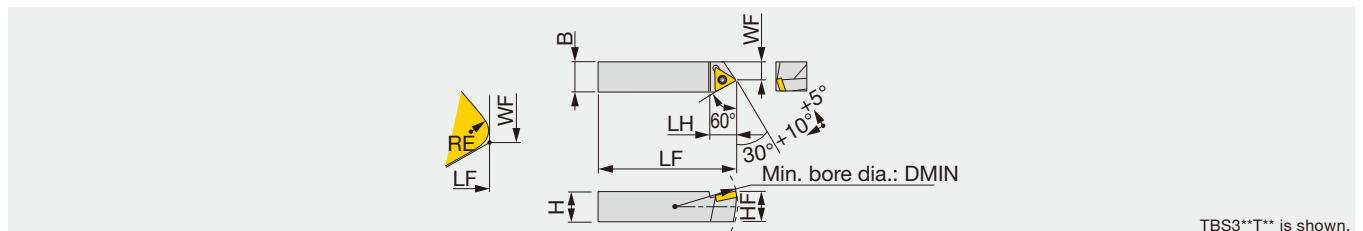

Designation	DMIN	WF	HF	LH	B	H	LF	RE**	Insert
TBS308T08	25	4.7	7.8	8	8	8	40	0.4	TP**0802...
TBS310T09	38	6	9.8	11	10	10	50	0.4	TP**0902...
TBS313T11	50	8.3	12.8	12	13	13	60	0.4	TP**1102...
TBS316C12	62	9.7	15.8	21	16	16	80	0.8	CP**1204...
TBS319C12	72	12.7	18.8	21	19	19	95	0.8	CP**1204...

- Figures shown above are of 13 mm or smaller square shanks used for normal direction of rotation.
- For the tools used for reverse direction of rotation, add H in the end of the designation. (Example: TBS308T08H)
- Use left-hand inserts (L) for normal direction of rotation, and right-hand inserts (R) for reverse direction of rotation.

SPARE PARTS

Designation	Clamping screw	Shim screw	Shim	Wrench 1	Wrench 2
TBS308T08	CSTB-2L	-	-	-	T-6F
TBS310T09	CSTB-2.2	-	-	-	T-7F
TBS313T11	CSTB-2.5	-	-	-	T-8F
TBS316C12	CSTB-5	-	-	-	T-20F
TBS319C12	CSTB-4F	DTS6-4	SSC4T3-P	P-4	T-15F

Reference pages: TBS1, TBR3: Inserts → **B142** - (TP**), **B118** - (CP**), CBN → **B199** -, PCD → **B217** -



TBS4

Square shank, with 45° approach angle, screw-on type

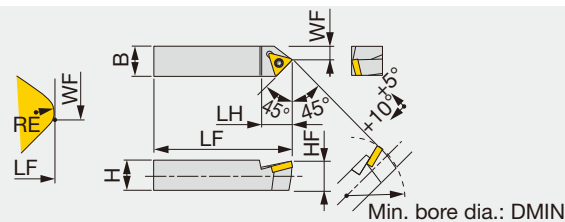

TBS4**T** is shown.

Designation	DMIN	WF	HF	LH	B	H	LF	RE**	Insert
TBS408T08	25	3.2	7.8	9	8	8	40	0.4	TP**0802...
TBS410T09	38	4.2	9.8	10	10	10	50	0.4	TP**0902...
TBS413T11	50	6.2	12.8	14	13	13	60	0.4	TP**1102...
TBS416C12	62	7.3	15.8	22	16	16	80	0.8	CP**1204...
TBS419C12	72	10.3	18.8	22	19	19	95	0.8	CP**1204...
TBS425C16	82	14.2	24.8	26	25	25	125	1.2	CP**1605...

- Figures shown above are of 13 mm or smaller square shanks used for normal direction of rotation.
- For the tools used for reverse direction of rotation, add H in the end of the designation. (Example: TBS308T08H)
- Use left-hand inserts (L) for normal direction of rotation, and right-hand inserts (R) for reverse direction of rotation.

SPARE PARTS

Designation	Clamping screw	Shim screw	Shim	Wrench 1	Wrench 2
TBS408T08	CSTB-2L	-	-	-	T-6F
TBS410T09	CSTB-2.2	-	-	-	T-7F
TBS413T11	CSTB-2.5	-	-	-	T-8F
TBS416C12	CSTB-5	-	-	-	T-20F
TBS419C12	CSTB-4F	DTS6-4	SSC4T3-P	P-4	T-15F
TBS425C16	CSTB-4F	DTS6-4	SSC54-P	P-4	T-15F

TBR1

Round shank, with 90° approach angle, screw-on type

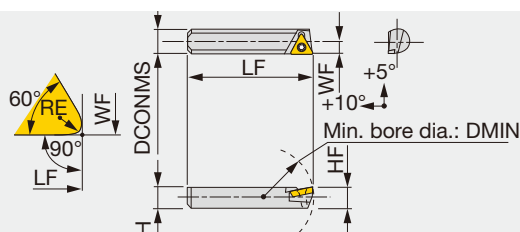

TBR1**T** is shown.

Designation	DMIN	WF	HF	H	DCONMS	LF	RE**	Insert
TBR108T08	30	4	7	7	8	35	0.2	TP**0802...
TBR110T09	40	5	8.5	8.5	10	50	0.2	TP**0902...
TBR112T11	50	6	10.5	10.5	12	60	0.2	TP**1102...

- Figures shown above are of 8 mm or larger diameter shank used for normal direction of rotation.
- For the tools used for reverse direction of rotation, add H in the end of the designation. (Example: TBR105E04H)
- For the tools for normal direction of rotation, use a left hand insert, and for reverse direction of rotation, use a right hand insert.

SPARE PARTS

Designation	Clamping screw	Wrench
TBR108T08	CSTB-2L	T-6F
TBR110T09	CSTB-2.2	T-7F
TBR112T11	CSTB-2.5	T-8F

Reference pages: TBS4, TBR1: Inserts → **B142** - (TP**), **B118** - (CP**), CBN → **B199** -, PCD → **B217** -

TBR3

Round shank, with 30° approach angle, screw-on type

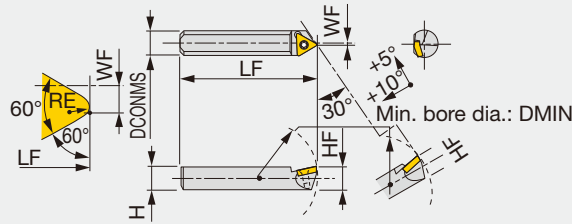

TBR3**T** is shown.

Designation	DMIN	WF	HF	H	DCONMS	LF	RE**	Insert
TBR305E04	19	0.5	4	4	5	20	0.2	EP**0401...
TBR308T08	30	0.5	7	7	8	35	0.2	TP**0802...
TBR312T11	50	1	10.5	10.5	12	60	0.4	TP**1102...
TBR316T16	60	1.5	14	14	16	80	0.8	TP**16T3...

- Figures shown above are of 8 mm or larger diameter shank used for normal direction of rotation.
- For the tools used for reverse direction of rotation, add H in the end of the designation. (Example: TBR105E04H)
- For the tools for normal direction of rotation, use a left hand insert, and for reverse direction of rotation, use a right hand insert.

SPARE PARTS



Designation	Clamping screw	Wrench
TBR305E04	CSTB-2	T-6F
TBR308T08	CSTB-2L	T-6F
TBR312T11	CSTB-2.5	T-8F
TBR316T16	CSTB-4	T-15F

TBR4

Round shank, with 45° approach angle, screw-on type

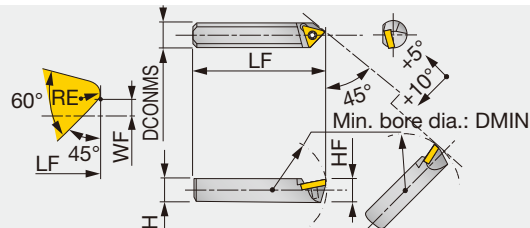

TBR4**T** is shown.

Designation	DMIN	WF	HF	H	DCONMS	LF	RE**	Insert
TBR406E04	24	0	5	5	6	25	0.2	EP**0401...
TBR408T08	30	0.5	7	7	8	35	0.2	TP**0802...
TBR410T09	40	1	8.5	8.5	10	50	0.2	TP**0902...
TBR412T11	50	1	10.5	10.5	12	60	0.4	TP**1102...
TBR416T16	60	1.5	14	14	16	80	0.8	TP**16T3...

- Figures shown above are of 8 mm or larger diameter shank used for normal direction of rotation.
- For the tools used for reverse direction of rotation, add H in the end of the designation. (Example: TBR105E04H)
- For the tools for normal direction of rotation, use a left hand insert, and for reverse direction of rotation, use a right hand insert.

SPARE PARTS



Designation	Clamping screw	Wrench
TBR406E04	CSTB-2	T-6F
TBR408T08	CSTB-2L	T-6F
TBR410T09	CSTB-2.2	T-7F
TBR412T11	CSTB-2.5	T-8F
TBR416T16	CSTB-4	T-15F

Top-Borer Tool



Features

- Indexable insert jig boring tools usable for commercially available adjustable boring heads.
- Minimum bore diameter $\phi 5.5$ mm.
- Available in three types of SEXP, SWUB and STUP.



Applicable for PINZBOHR small diameter finish boring heads.
(See page **K178**)

Applications by Type

SEXP		<ul style="list-style-type: none"> ● Minimum bore diameter: $\phi 5.5$ mm. ● A 75° rhombic insert is used. Stable insert holding assures precision boring.
SWUB		<ul style="list-style-type: none"> ● Available in two sizes of minimum bore diameters of $\phi 7$ and $\phi 8$ mm. ● Uses an economical trigon insert.
STUP		<ul style="list-style-type: none"> ● Available in five sizes of minimum bore diameters of $\phi 10$, $\phi 12$, $\phi 14$, $\phi 16$ and $\phi 18$ mm. ● Many standard items make them applicable for a wide range of applications.

S/C-SEXPR/L

Top borer tool, for positive 75° rhombic inserts, screw-on type

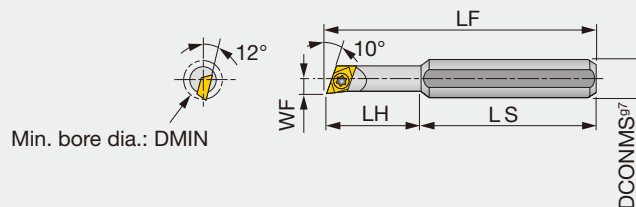

Designation	Material	DMIN	DCONMS	WF	LF	LH	LS	RE**	Insert
S08055-SEXPR04	Steel	5.5	8	2.8	45	19	26	0.4	EP**0401...
S10055-SEXPR04	Steel	5.5	10	2.8	51	19	32	0.4	EP**0401...
S12055-SEXPR04	Steel	5.5	12	2.8	51	19	32	0.4	EP**0401...
C10055-SEXPR04	Carbide	5.5	10	2.8	62	30	32	0.4	EP**0401...
C12055-SEXPR04	Carbide	5.5	12	2.8	62	30	32	0.4	EP**0401...

SPARE PARTS

Designation	Clamping screw	Wrench
S/C-SEXPR	CSTB-2	T-6F

Note: Use right-hand tool holders (R) with left-hand inserts (L); and left-hand tool holders (L) with right-hand inserts (R).

Reference pages: S/C-SEXPR/L: Inserts → **B218 -**, CBN → **B195**, PCD → **B214**

S/C-SWUBR

Top borer tool, for positive 80° trigon inserts with 5° clearance, screw-on type

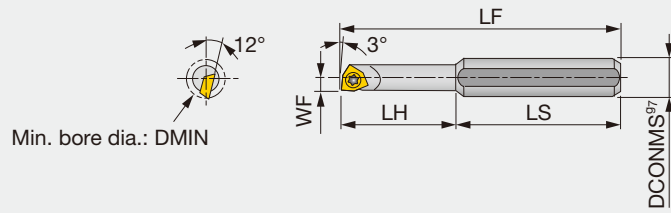

Right hand (R) shown.

Designation	Material	DMIN	DCONMS	WF	LF	LH	LS	RE**	Insert
S1008-SWUBR03	Steel	8	10	4.1	60	28	32	0.4	WBG0301...
S1208-SWUBR03	Steel	8	12	4.1	60	28	32	0.4	WBG0301...
C1008-SWUBR03	Carbide	8	10	4.1	76	44	32	0.4	WBG0301...
C1208-SWUBR03	Carbide	8	12	4.1	76	44	32	0.4	WBG0301...

SPARE PARTS

Designation	Clamping screw	Wrench
S/C-SWUBR	CSTB-2	T-6F

Note: Use right-hand tool holders (R) with left-hand inserts (L); and left-hand tool holders (L) with right-hand inserts (R).

S/C-STUPR/L

Top borer tool, for positive 60° triangular inserts with 11° clearance, screw-on type

8° (6° for $\phi Dm = 12$ or larger)

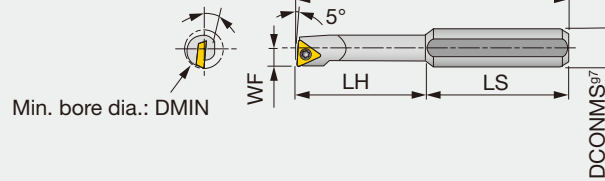

Right hand (R) shown.

Designation	Material	DMIN	DCONMS	WF	LF	LH	LS	RE**	Insert
S0810-STUPR08	Steel	10	8	5	61	-	-	0.4	TPGT0802...
S1010-STUPR08	Steel	10	10	5	67	35	32	0.4	TPGT0802...
S1210-STUPR08	Steel	10	12	5	67	35	32	0.4	TPGT0802...
S1212-STUPR08	Steel	12	12	6	74	42	32	0.4	TPGT0802...
S1212-STUPR11	Steel	12	12	6	74	42	32	0.4	TP*T1102...
S1214-STUPR11	Steel	14	12	7	81	-	-	0.4	TP*T1102...
C1010-STUPR08	Carbide	10	10	5	87	55	32	0.4	TP*T0802...
C1210-STUPR08	Carbide	10	12	5	87	55	32	0.4	TP*T0802...
C1212-STUPR11	Carbide	12	12	6	98	66	32	0.4	TP*T1102...
C1214-STUPR11	Carbide	14	12	7	109	84	25	0.4	TP*T1102...

SPARE PARTS

Designation	Clamping screw	Wrench
S**10-STUPR08	CSTB-2L040	T-6F
S1212-STUPR08	CSTB-2L	T-6F
S121*-STUPR11	CSTB-2.5	T-8F
C1*10-STUPR08	CSTB-2L040	T-6F
C121*-STUPR11	CSTB-2.5	T-8F

Note: Use right-hand tool holders (R) with left-hand inserts (L); and left-hand tool holders (L) with right-hand inserts (R).



**Go digital with your tool inventory control and management!
Automated purchasing for time saving and tool cost reduction!**



Always the right tools for the job.
And they are just a few taps away



Accurate and reliable statistics
are stored and can be accessed







Fully managed environment that let
you focus more on production



- Automatic calculation of re-order points and purchasing
- Alerts for stock shortages
- Streamline purchasing. Revolutionary planning engine ensures that needed items will be ordered and at the point of use on time



- Smart multidimensional reports for full up-to-date coverage of your inventory
- Analyzer app for quick overview of key performance data
- Sophisticated planning engine and reporting ensure maximum availability with minimum stock

Model	MAXI Premium	MINI	DLS 8D / DLS 4D	TOOLPORT
Cabinet external view	First Choice ! 			
Features	<p>Now with larger touchscreen</p> <ul style="list-style-type: none"> - Capacity: 3,000 - 5,000 items or more - High performance PC (i5), 2D barcode reader, fingerprint reader - Company logos are printed on the sides upon request - Two year hardware warranty - Touchscreens are optional (mandatory for the first cabinet) 	<p>First choice for small to medium stock sizes</p> <ul style="list-style-type: none"> - Capacity: 1,000 - 2,000 items - Smaller in size with fewer drawers than MAXI - Sits atop of DLS 4D 	<p>Economical series with spacious open drawers</p> <ul style="list-style-type: none"> - 8 or 4 drawers per cabinet (DLS 4D is POD version only) - Electrically locked drawers - Flexible drawer partitions - Also suitable for long and large diameter tools 	<p>Dispenses single inserts and small items, one by one</p> <ul style="list-style-type: none"> - 8 or 4 single insert drawers - Secure environment for expensive inserts and tools
Drawers per cabinet/capacity	1 - 12 (depends on drawer heights and quantity of Auto-Locks)	1 - 5 (depends on drawer heights and quantity of Auto-Locks)	DLS 8D: 8 drawers DLS 4D: 4 drawers	8D: 1600 inserts 4D: 800 inserts
Drawer heights	50 mm, 75 mm, 100 mm, 125 mm	50 mm, 75 mm, 100 mm	DLS 8D: 75 mm x 3, 100 mm x 4, 175 mm x 1 DLS 4D: 75 mm x 1, 100 mm x 2, 175 mm x 1 (Net heights)	-
Load weight per drawer	Up to 50 kg (90 kg for JUMBO drawer)	Up to 20 kg	180 kg	-
Cabinet weight	400 kg - 600 kg (varies depending on number of drawers and Auto-Locks)	165 kg (varies depending on number of drawers and Auto-Locks)	270 kg (varies depending on number of drawers and drawer configurations)	222 kg (varies depending on number of drawers)
Cabinet dimensions (WxDxH)	1180 mm x 752 mm x 1469 mm	860 mm x 581 mm x 800 mm	DLS 8D: 915 mm x 610 mm x 1220 mm DLS 4D: 915 mm x 610 mm x 820 mm	8D: 676 mm x 630 mm x 1475 mm 4D: 676 mm x 630 mm x 905 mm
Electrical supply	100V - 230V	100V - 230V	100V - 230V	100V - 230V

More Digital Solutions of MATRIX



MATRIX ANDROID

Tool Crib Management from the palm of your hand! MATRIX app that manages traditional warehouse and tool room.



MATRIX POUCH

Always the Right Tools for the Job! MATRIX Pouch reads Balluff chip (Type C) on tool adapter. Data string with tool assembly code is then transmitted to MATRIX for quick "error proof" access restricted to those tools approved for the job.



MATRIX RTLS

MATRIX Real Time Location System tracks production assets as they move around the shop floor. Provides 100% Visibility for items even after they leave the tool room.



Alphanumeric Index

Tooling system

Designation	Product name	Page
104.□□□.□□□.□□□	SwissBore master shank holder for ANSI B5.50	K175
114.□□□.□□□.□□□	SwissBore master shank holder for DIN 69871 A/D	K174
124.□□□.□□□.□□□	SwissBore master shank holder for DIN 69871 B	K174
134.□□□.□□□.□□□	SwissBore master shank holder for MAS-BT	K173
144.□□□.□□□.□□□	SwissBore master shank holder for DIN 69893 HSK A	K172
154.□□□.□□□.□□□	SwissBore master shank holder for PSC(TungCap)	K173
164.□□□.□□□.□□□	SwissBore extension adapter	K176
16D.RINGSEMC	Driving ring	K153
184.□□□.□□□.□□□	SwissBore reduction adapter	K177
2□D.RINGSEMC	Driving ring	K153
206.064.025.045	SwissBore digital fine boring head	K053, K167
254.□□□.□□□.□□□	TungCap / SwissBore boring bar	K053, K167
256.□□□.□□□.□□□	TungCap / SwissBore boring bar	K053, K168
305.□□□.□□□.□□□	SwissBore digital fine boring head	K169
314.□□□.□□□.□□□	TungCap / SwissBore insert holder, 90° corner	K054, K170, K171
32D.RINGSEMC	Driving ring	K153
40D.RINGSEMC	Driving ring	K153
50D.RINGSEMC	Driving ring	K153
A		
ADJBT□□D70ER32	ER collet chuck holder with center alignment	K106
ADJC□ER32	TungCap ER collet chuck holder with center alignment	K041
ADJDIN69871□□D70ER32	ER collet chuck holder with center alignment	K070
ADJHKA□□D70ER32	ER collet chuck holder with center alignment	K085
ADJST□□D70ER32	ER collet chuck holder with center alignment	K117
AT□-0 R/L	Cartridge, A-type	K198
B		
BT□□-FMA...	Cutter body holder	K101
BT□□-FMC...	Cutter body holder	K101
BT□□CF4-...	Quick change holder	K107
BT□□DCB1...	Drill chuck (Jacobs taper)	K104
BT□□EM□□X...	Side lock holder (weldon)	K094
BT□□EM□□X□□□E...	Side lock holder (whistle notch)	K095
BT□□ER□□SHORT...	ER collet chuck holder	K090
BT□□ER□□X...	ER collet chuck holder	K089
BT□□ER32CLICK-IN	Quick change holder	K107
BT□□FC-C□-...	TungCap basic holder with dual contact	K048
BT□□FC-C□-□□□T	TungCap basic holder with dual contact	K049
BT□□FCEM□□X...	Side lock holder (weldon)	K093
BT□□FCER□□X...	ER collet chuck holder	K088
BT□□FCFM...	Shell mill holder	K098
BT□□FCHYDRO□□X...	Hydraulic endmill chuck holder	K090
BT□□FCMAXIN□□X...	Power chuck holder	K091
BT□□FCSEM□□X...	Shell mill holder	K098
BT□□FCSRK□□X...	TungShrink Thermal shrinking holder (carbide shank only)	K095
BT□□FCSRKIN□□X...	TungShrink Thermal shrinking holder	K096
BT□□FM□□x...	Shell mill holder	K100
BT□□HYDRO□□X...	Hydraulic endmill chuck holder	K092
BT□□MAXIN□□X...	Power chuck holder	K091

Designation	Product name	Page
BT□□MT□□DRW	Morse taper holder with draw bar	K105
BT□□MT□□X...	Morse taper holder	K105
BT□□ODP□□X...	Modular system	K103
BT□□SEM□□X...	Shell mill holder	K099
BT□□SEM□□X□□□C	Shell mill holder	K100
BT□□SEM□□X□□X□□□C	Shell mill holder, long type	K100
BT□□SEM□□X...	Combination holder for slot mill and shell mill	K102
BT□□SRK□□X...	TungShrink Thermal shrinking holder (carbide shank only)	K097
BT□□SRKIN□□X...	Thermal shrinking holder	K097
BT4-FBHO-DE-1690	TungCap digital boring head	K053
BT40EM□□X45C	Side lock holder with coolant nozzle (weldon)	K094
BT50AD...	Conversion adapter	K104
C		
C□-C□RE-...	TungCap reduction adapter	K051
C□-DTIR-□□□□□-D...	TungCap manual clamping unit	K056
C□-DТОFR/L...	TungCap manual clamping unit	K056
C□-DTOS□□□□R/L	TungCap manual clamping unit	K056
C□-TB-...	TungCap test bar	K051
C□□□-STUPR...	Top borer tool	K203
C□□□55-SEXPR04	Top borer tool	K202
C□□□08-SWUBR03	Top borer tool	K203
C□ABB□□-...	TungCap adapter for boring bar	K026
C□ACLNN□□□□□-12	TungCap external/facing toolholder	K009
C□ACLNN□□□□□-12N	TungCap external/facing toolholder	K009
C□ACLNR/L□□□□□-0904N	TungCap external/facing toolholder	K008
C□ACLNR/L□□□□□-12N	TungCap external/facing toolholder	K008
C□ADCATI□□X...	TungCap CAT basic holder	K050
C□ADCATI□□X□□□ADB	TungCap CAT basic holder	K050
C□ADE-□□R/L	TungCap adapter for external square shank	K021
C□ADES-20	Adapter for square shank toolholders	K022
C□ADHKA□□□□WHX...	TungCap basic holder for HSK	K049
C□ADI...	TungCap adapter for boring bar	K028
C□ADJNR/L□□□□□-1104N	TungCap external/profiling toolholder	K011
C□ADJNR/L□□□□□-15N	TungCap external/profiling toolholder	K011
C□ADNN□□□□□-15	TungCap external/profiling toolholder	K016
C□ADNN□□□□□-15N	TungCap external/profiling toolholder	K016
C□ADQNR/L□□□□□-15N	TungCap profiling toolholder	K017
C□ADSKA□□X...	TungCap basic holder with dual contact	K049
C□ADSKA□□X□□ADB	TungCap basic holder with dual contact	K049
C□ASHA...	TungCap adapter for external square shank	K021
C□ASHR/L...	TungCap adapter for external square shank	K021, K022
C□ASHR/L□□-45	Adapter for square shank toolholders (with 45° slanted)	K022
C□ATJNR/L□□□□□-16N	TungCap external/profiling toolholder	K013
C□AVJNR/L□□□□□-1204N	TungCap external/profiling toolholder	K014
C□AVJNR/L□□□□□-16N	TungCap external/profiling toolholder	K014
C□AWLNR/L□□□□□-0604N	TungCap external/facing toolholder	K010
C□AWLNR/L□□□□□-08N	TungCap external/facing toolholder	K010
C□CER/L□□□□□-16ER	TungCap external threading toolholder	K029
C□CER/L□□□□□-16ERN	TungCap external threading toolholder	K029

Designation	Product name	Page
C□CHFVN□□□□□-CHP	TungCap perpendicular toolholder for adapters with high pressure coolant capability	K034
C□CHFVR/L□□□□□N	TungCap perpendicular toolholder for adapters	K032
C□CHSN□□□□□-CHP	TungCap toolholder for adapters with high pressure coolant capability	K034
C□CHSR/L□□□□□N	TungCap toolholder for adapters	K032
C□EM□□X...	TungCap Side lock holder for endmill	K038
C□EM□□X□□E	TungCap Side lock holder for endmill	K039
C□EPA□□M□□□R03L...	TungCap Tung-Tri cutter body	K037
C□ER□□X...	TungCap collet chuck holder	K040
C□ER□□X□□□M	TungCap ER Mini collet chuck holder	K041
C□EX-...	TungCap Extension adapter	K050
C□MAXIN□□X...	TungCap power chuck holder	K049
C□ODP□□X...	TungCap modular system	K044
C□PCLNR/L□□□□□-0904-CHP	TungCap external/facing toolholder with high pressure coolant nozzle	K009
C□PCLNR/L□□□□□-12-CHP	TungCap external/facing toolholder with high pressure coolant nozzle	K009
C□PCLNR/L□□□□□-12N	TungCap external/facing toolholder	K008
C□PCLNR□□□□□-0904	TungCap internal/facing toolholder	K023
C□PCLNR□□□□□-12	TungCap internal/facing toolholder	K023
C□PDJNR/L□□□□□-1104-CHP	TungCap external/profiling toolholder with high pressure coolant nozzle	K012
C□PDJNR/L□□□□□-15-CHP	TungCap external/profiling toolholder with high pressure coolant nozzle	K012
C□PDJNR/L□□□□□-15N	TungCap external/profiling toolholder	K012
C□PVJNR/L□□□□□-16-CHP	TungCap external/profiling toolholder	K014
C□PWLNR/L□□□□□-08-CHP	TungCap external/facing toolholder with high pressure coolant nozzle	K010
C□SCA□□-...	TungCap slot milling holder	K048
C□SCLCR□□□□□-09	TungCap internal/facing toolholder	K023
C□SDXXR□□□□□-07	TungCap internal/profiling toolholder	K025
C□SEM□□X□□□C	TungCap shell mill holder	K043
C□SRKIN□□X...	TungCap Thermal shrinking holder	K047
C□STCR/L□□□□□-18-CHP	TungCap external threading/grooving toolholder with high pressure coolant capability	K030
C□SVJCR/L□□□□□-11N	TungCap external/profiling toolholder	K015
C□SVJCR/L□□□□□-16	TungCap external/profiling toolholder	K015
C□SVJCR/L□□□□□-16N	TungCap external/profiling toolholder	K015
C□SVQBR□□□□□-11	TungCap internal/profiling toolholder	K026
C□SVQBR□□□□□-16	TungCap internal/profiling toolholder	K026
C□SVVCN□□□□□-16	TungCap external/profiling toolholder	K016
C□SVVCN□□□□□-16N	TungCap external/profiling toolholder	K016
C□TDX□□□L□□□-3	TungCap TungDrill-Twisted drill body	K036
C□TLA15M□□□R□□L...	TungCap Tung-Tri cutter body	K037
C3CEL18065-16ERB-CHP	TungCap external threading toolholder with high pressure coolant nozzle	K030
C3CEL22040-16ERN-B	TungCap external threading toolholder	K029
C3PTUNL□□□□□-16-CHP	TungCap profiling toolholder	K020
C3SCLCL□□□□□-09-CHP	TungCap external/facing toolholder with high pressure coolant nozzle	K011
C3SDJCR/L22040-11-CHP	TungCap external/profiling toolholder with high pressure coolant nozzle	K015
C3SDUCL□□□□□-11-CHP	TungCap profiling toolholder	K020
C3STCFL□□□□□-18-CHP	TungCap external threading/grooving toolholder with high pressure coolant capability	K031
C3SVUCL18065-11-CHP	TungCap profiling toolholder	K020
C4ADUNR/L27050-15N	TungCap profiling toolholder	K019
C4ADUNR□□□□□-15	TungCap internal/profiling toolholder	K024
C4AVQNR/L27050-16N	TungCap profiling toolholder	K017
C4PDUNR/L17080-11	TungCap internal/profiling toolholder	K024
C4PTJNR/L27050-1104N	TungCap external/profiling toolholder	K013
C4PWLNR/L□□□□□-0604-CHP	TungCap external/facing toolholder with high pressure coolant nozzle	K010
C4STCR/L27050-27-CHP	TungCap external threading/grooving toolholder with high pressure coolant capability	K031
C4SWLXR11070-04	TungCap internal/facing toolholder	K024
C5PCLNR/L35060-12	TungCap external/facing toolholder	K008
C6ACLNR/L45065-16N	TungCap external/facing toolholder	K008
C6ACMNN□□□□□-0904N	TungCap external/facing toolholder	K018
C6ACMNN□□□□□-12N	TungCap external/facing toolholder	K018
C6PCLNL17100-12-CHP	TungCap internal/facing toolholder with high pressure coolant nozzle	K023
C6PCMNN00130-12-CHP	TungCap external/facing toolholder with high pressure coolant nozzle	K018
C6PDMNL00130-1104-CHP	TungCap external/profiling toolholder with high pressure coolant nozzle	K019

Designation	Product name	Page
C6PDUNL17100-1104-CHP	TungCap internal/profiling toolholder with high pressure coolant nozzle	K025
C6TBK-32R/L	TungCap adapter for parting blades	K036
C8FM60X60	TungCap cutter body holder	K044
CABM□□M...	TungFlex extension	K121
CAER/L-□T...	TungCut external grooving and turning adapters	K033
CAER/L-□T□□-CHP	TungCut external grooving/parting adapters for high pressure coolant capability	K035
CAFR/L-□T□□-...	TungCut face grooving and turning adapters	K033
CDPER□□M...	TungFlex ER collet chuck holder	K122
CDPM□□SRK□□X...	TungFlex thermal shrinking holder (for carbide shank)	K122
COOLINGTUBEHSKA...	Cooling tube for HSK	K153
CSKER10CA-09	Cartridge	K187
CSKPR/L□□CA...	Cartridge	K186
CSSER12CA-12	Cartridge	K191
CSSPR/L□□CA...	Cartridge	K191
CSYPR/L□□CA...	Cartridge	K196
CTFER/L□□CA...	Cartridge	K183
CTFPR/L□□CA...	Cartridge	K182
CTGER/L□□CA...	Cartridge	K185
CTGPR/L□□CA...	Cartridge	K184
CTSER10CA-11	Cartridge	K193
CTSPR/L□□CA...	Cartridge	K192
CTTER□□CA...	Cartridge	K195
CTTPR/L□□CA...	Cartridge	K194
CTWPR/L□□CA...	Cartridge	K189
D		
DIN2080□□CP...	Center plug	K112
DIN2080□□DCB□□X...	Drill chuck (Jacobs taper)	K110
DIN2080□□EM...	Side lock holder (weldon)	K108
DIN2080□□ER□□X...	ER collet chuck holder	K108
DIN2080□□FM...	Cutter body holder	K109
DIN2080□□MT□DRW	Morse taper holder with draw bar	K111
DIN2080□□MT□X...	Morse taper holder	K111
DIN2080□□SEM□□X...	Cutter body holder	K108
DIN2080□□SEMC□□X...	Combination holder for slot mill and shell mill	K110
DIN208050AD40	Conversion adapter	K111
DIN69871□□CF4...	TungFit quick change holder	K071
DIN69871□□DCB□□X...	Drill chuck (Jacobs taper)	K067
DIN69871□□EM□□X...	Side lock holder (weldon)	K063
DIN69871□□EM□□X□□□E...	Side lock holder (whistle notch)	K064
DIN69871□□ER□□SHORT	ER collet chuck holder	K061
DIN69871□□ER□□X...	ER collet chuck holder	K060
DIN69871□□FM...	Cutter body holder	K066
DIN69871□□HYDRO□□X...	Hydraulic endmill chuck holder	K062
DIN69871□□MAXIN□□X...	Endmill holder	K061
DIN69871□□MT□DRW	Morse taper holder with draw bar	K069
DIN69871□□MT□X...	Morse taper holder	K068
DIN69871□□ODP□□X...	TungFlex modular system	K072
DIN69871□□SEM□□X...	Shell mill holder	K065
DIN69871□□SEM□□X□□□□C	Shell mill holder, long type	K066
DIN69871□□SEMC□□X...	Combination holder for slot mill and shell mill	K067
DIN69871□□SRK□□X...	Thermal shrinking holder	K064
DIN69871□□SRKIN□□X...	Thermal shrinking holder	K065
DIN6987140ADDIN208030	Conversion adapter	K068
DIN6987140ER32CLICK-IN	Quick change holder (TungClick)	K071
DIN6987150ADB/TK40	Conversion adapter	K068
DIN69880 □□ HYDRO...	Hydraulic chuck holder	K116
E		
EASYLOCKT.CEU	Electrical nut-clamp torque control device	K155
ER...	ER collet	K125
ER□□CF4-...	TungFit ER collet chuck adapter	K123
ER□□SEAL□□AA	ER sealed spring collet	K128
ER□□SEAL□□AAJET	ER sealed spring collet	K129
ER□□SPR□-...	ER spring collet	K126
ER□□SPR□-□AA	ER spring collet	K127
ER□□SPR□-□...	ER spring collet	K126
ER□□SPR□-□-□AA	ER spring collet	K127
ER□□SPR□□-...	ER spring collet	K126
ER□□SPR□□-□□AA	ER spring collet	K127
ER□□SPR□□-□□AA	ER spring collet	K127
ER□□SRK□□X...	TungShrink ER collet type	K141
ER□□SRK□□X□□JET2	TungShrink ER collet type	K142
ER11SPR□□AA	SpinJet ER11 collet	K160
ER11SRK□□X...	SpinJet thermal shrinking ER collet	K160

Alphanumeric Index

Designation	Product name	Page
ER32ODPM□□X...	TungFlex collet for ER collet chuck	K140
ER32SRF□□X...	TungShrink -quick change type	K144
ER32SRF□□X□□JET2	Thermal shrinking holder adapter	K144
EXCF4-...	TungFit extension adapter	K123
EXTRACTORSCCOLLETS	SC collet extracting hook	K047, K150

G

GFIMT□ER...	Collet chuck	K119
GFIST□□ER...	Collet chuck	K119
GH1-DA2.BG0.077	TungCap / SwissBore digital display unit	K054, K166
GTIBT□□ER...	Tapping holder	K107
GTIDIN69871□□ER...	TungGTI tapping holder	K071
GTIER□□ST□□X...	TungGTI tapping holder	K116
GTINER32DIN□□□□X...	Tapping attachment (DIN)	K145
GTINER32ISO□□□□X...	Tapping attachment (ISO)	K145
GTINER32JIS□□□□X...	Tapping attachment (JIS)	K146
GYROST□□ER...	TungGyro collet holder for lathes	K117

H

HA6-FBHO-DE-1695	TungCap digital boring head	K053
HSK□□A-C□-...	TungCap basic holder for HSK	K049
HSKA□□B16MN...	Blank for holders	K087
HSKA□□CF4-S	TungFit quick change holder	K086
HSKA□□EM□□X...	Side lock holder (weldon)	K079
HSKA□□EM□□X□□E	Side lock holder (whistle notch)	K079
HSKA□□ER□□SHORT	ER collet chuck holder	K075
HSKA□□ER□□X...	ER collet chuck holder	K074
HSKA□□ER□□X□□□M	ERMini collet chuck holder	K073
HSKA□□HYDRO□□X...	TungHydro hydraulic endmill holder	K077, K078
HSKA□□MAXIN□□X...	TungMax endmill holder	K075
HSKA□□MAXIN□□X□□BIN	TungMax endmill holder	K076
HSKA□□MT□□X...	Morse taper holder	K085
HSKA□□ODP□□X...	Modular system	K086
HSKA□□SEM□□X...	Shell mill holder	K083
HSKA□□SEM□□X□□	Combination holder for slot mill and shell mill	K084
HSKA□□SRK□□X...	TungShrink Thermal shrinking holder	K080
HSKA□□SRKIN□□X...	TungShrink Thermal shrinking holder	K080
HSKA100FM60X70	Shell mill holder	K084
HSKA63ER32CLICK-IN	Quick change holder	K085
HSKA63ER32X120BIN	ER collet chuck holder	K076
HSKE□□ER□□X...	ER collet chuck holder	K073
HSKE□□ODP□□X...	Modular system	K087
HSKE□□SEM□□X...	Shell mill holder	K082
HSKE□□SRK□□X...	TungShrink Thermal shrinking holder	K081
HSKFM□□ER□□X...	ER collet chuck holder	K075
HSKFM63SEM□□X...	Shell mill holder	K083
HSKFM63SEM1X2.375	Shell mill holder	K083
HSKFM63SEM3/4X...	Shell mill holder	K083
HSKFM63SRKIN25X115	TungShrink Thermal shrinking holder	K081

I

IND SHRINK IN UNIT EUR	Induction heating unit for shrink tool chucking	K143
IND SHRINK START UNIT EUR	Induction heating unit for shrink tool chucking	K143
INDER11TOOLADAPTER	Thermal shrinking collet	K160

K

KITBT40HYDRO□□X...	TungHydro hydraulic chuck kit	K136
KITDIN2080□□□□ER...	ER collet type taper shank & collet (kit)	K132
KITDIN6987140HYDRO□□X...	TungHydro hydraulic chuck kit	K136
KITGTIER□□ST□□X...	Tapping attachment kit	K116
KITGYRO□□D69880ER...	TungGyro	K118
KITGYROST□□ER...	TungGyro	K118
KITHSKA63HYDRO□□X...	TungHydro hydraulic chuck kit	K136
KITMT□□□□ER...	ER collet type taper shank & collet (kit)	K132
KITR-81□□ER...	ER collet type taper shank & collet (kit)	K132
KITSK□□MAXIN□□X...	TungMax milling kit	K138
KITST□□X□□□□ER...	ER collet straight shank kit	K133
KITST□□X□□□□□ER□□M	ERMini collet straight shank kit	K133

M

M□□CLAMPSCREWSEM...	Clamp screw for shell mill holder	K151
MATRIX	Tool management system	K204
MT□□ER□□X...	ER collet chuck holder	K117
MULTICLAMP□□□□/...	Multi-clamp fixture for HSK shank	K154
MULTICLAMPC...	TungCap multi-clamp fixture	K051

Designation	Product name	Page
N		
NUTER...	UM/Mini nut for ER collet chuck	K148
NUTER□□SHORT	Nut for ER collet chuck	K149
NUTER□□TOP	Nut for ER collet chuck	K149
NUTER□□TOPBIN	Balanceable nut for ER collet chuck	K149
NUTER11GHS	SpinJet Nut for Spinjet collet	K149, K161

P

PCLNR/L□□CA...	Cartridge	K188
PRESETER-JET□□X...	Preset screw for ER collet	K042, K151
PRESETERMAXIN□□X...	Preset screw for power chuck holder	K047, K151
PRESETSCCAP□□X...	Preset screw for straight collet	K046, K135
PRESETSCREWHYDROM...	Preset screw for hydraulic chuck	K138
PRESETSCREW□□X□□B	Preset screw with coolant hole for EME/SRKIN	K152
PSBT□□□□M...	Pull stud for BT with JIS/ANSI (MAZAK) knob	K146
PSBT□□□□M□□MAS...	Pull stud for BT with MAS knob	K147
PSC□□-FBHO-DE-16...	SwissBore digital boring head	K053
PSC□□-FBHS-DE-...	SwissBore fine boring head for digital display	K054
PSCAT□□□□M□□ISOB	Pull stud	K148
PSKNR/L□□CA...	Cartridge	K186
PSOTTBT□□M...	Pull stud	K148
PSSK□□□□M□□DIN...	Pull stud	K147
PSSNR/L□□CA...	Cartridge	K190
PSYNR/L□□CA...	Cartridge	K196
PTFNR/L□□CA...	Cartridge	K182
PTGNR/L□□CA...	Cartridge	K184
PTTNR/L□□CA...	Cartridge	K194

R

R-8ER□□X...	ER collet chuck holder	K112
-------------	------------------------	------

S

S□□□□-STUPR...	Top borer tool	K203
S□□□55-SEXPR04	Top borer tool	K202
S□□08-SWUBR03	Top borer tool	K203
SC□□SEAL...	SC straight collet	K046, K134
SC□□HYDRO...	Sealed collet for hydraulic chuck	K137
SC□□SPR...	SC straight collet	K046, K135
SC□□T□□A/B	TungCap sleeve for C-ABB adapter	K027
SCA□□□□-02	Collar for slot mill	K048
SCFPR/L06CA-05	Cartridge	K183
SCLPR/L06CA-05	Cartridge	K188
SCREW □□-□□ SEM...	Clamp screw for shell mill holder	K151
SCSPR/L06CA-05	Cartridge	K193
SCTPR06CA-05	Cartridge	K195
SEM22CF4C	TungFit shell mill adapter	K123
SETER□□S□□AAJETINCH	Set of ER sealed spring collets	K131
SETER□□SEAL□□AA	Set of ER sealed spring collets	K131
SETER□□SEAL□□AAINCH	Set of ER sealed spring collets	K131
SETER□□SEAL□□AAJET	Set of ER sealed spring collets	K131
SETER□□SPR...	Set of ER spring collets	K130
SETER□□SPR□□AA	Set of ER spring collets	K130
SETER□□SPR□□EM	Set of ER spring collets	K130
SETER32SRK□□6EUR	Set of ER collets with thermal shrink chucks	K143
SETSC□□SEAL...	Set of straight collet with coolant hole	K139
SETSC□□SPR...	Set of Straight collet	K139
SM□□-L□□□-C...	TungFlex steel modular shank	K120
SM□□-L□□□-C□□-C-H...	TungFlex carbide modular shank	K120, K121
SM□□-L□□□/□□□-CF4	TungFlex-TungFit conversion adapter	K121
SM□□-L□□C...	TungFlex steel modular shank	K120
SP□.ST□.K01...	SwissBore master shank holder for DIN 69871 B with face contact	K175
SRM□□X...	Clamp screw for endmill holder	K152
SSKPR□□CA...	Cartridge	K187
SSSPR/L□□CA...	Cartridge	K192
SSYPR10CA-09	Cartridge	K197
ST□□X□□□□ER...	ER collet chuck holder	K113
ST□□X□□□□ER□□M	ERMini collet chuck holder	K112
ST□□X□□□□ER□□MF	ERMini collet chuck holder	K114
ST□□X□□□□SRK...	TungShrink Thermal shrinking holder	K115
ST□□X□□□□ER□□MF	ERMini collet chuck holder	K113
ST□□X□□□□ER□□MFD	ER collet chuck holder, double end type	K114
ST□□X□□□□ER□□S	ER collet chuck holder, internal coolant supply	K115
ST16X50ER11MF	ERMini collet chuck holder	K112
STCAR/L18-CHP	TetraMini-Cut external grooving/parting adapter for high pressure coolant capability	K035

Designation	Product name	Page
STCAR/L27-CHP	TetraForce-Cut external grooving/parting adapter for high pressure coolant capability	K035
STFPR/L□□CA...	Cartridge	K183
STGPR/L□□CA...	Cartridge	K185
STSPR/L□□CA...	Cartridge	K193
STTPR/L□□CA...	Cartridge	K195
STWPR/L□□CA...	Cartridge	K189
T		
TBR1...	Boring bar	K200
TBR3...	Boring bar	K201
TBR4...	Boring bar	K201
TBS1...	Boring bar	K199
TBS3...	Boring bar	K199
TBS4...	Boring bar	K200
TESTBARHYDRO...	Torque test bar for hydraulic chuck	K138
TJSGJETBT...	SpinJet high speed spindle	K156
TJSGJETC...	SpinJet high speed spindle	K157
TJSGJETCAT40	SpinJet high speed spindle	K158
TJSGJETER32	SpinJet high speed spindle	K156
TJSGJETHSKA63	SpinJet high speed spindle	K157
TJSGJETST20	SpinJet high speed spindle	K158
TJSSHAFTLOCKKEYGJET	SpinJet shaft lock key	K158, K161
TJSTSDDISPLAY...	SpinJet wireless RPM display	K159
TOOLCLAMP...	Tool clamp fixture	K154
TUNGBORE-BT50EM□□ADB	Drill holder with BT shank	K106
TW-B-...	Blade for FixedTorqueWrench	K163
TW-D-□.□NM	Handle for FixedTorqueWrench	K163
W		
WRENCHCOOLTUBEHSK...	Wrench for HSK cooling tube	K154
WRENCHER...	Wrench for ER nut and ER collet chuck	K041, K150
WRENCHM□□SEMC...	Wrench for cutter arbor	K043, K153
WRENCHMAXIN□□HOOK	Wrench for power chuck holder	K046, K150

Grade
Insert
Ext. Toolholder
Int. Toolholder
Threading
Grooving
Miniature tool
Milling cutter
Endmill
Drilling tool
Tooling System
User's Guide
Index

A
B
C
D
E
F
G
H
I
J
K
L
M

MEMO

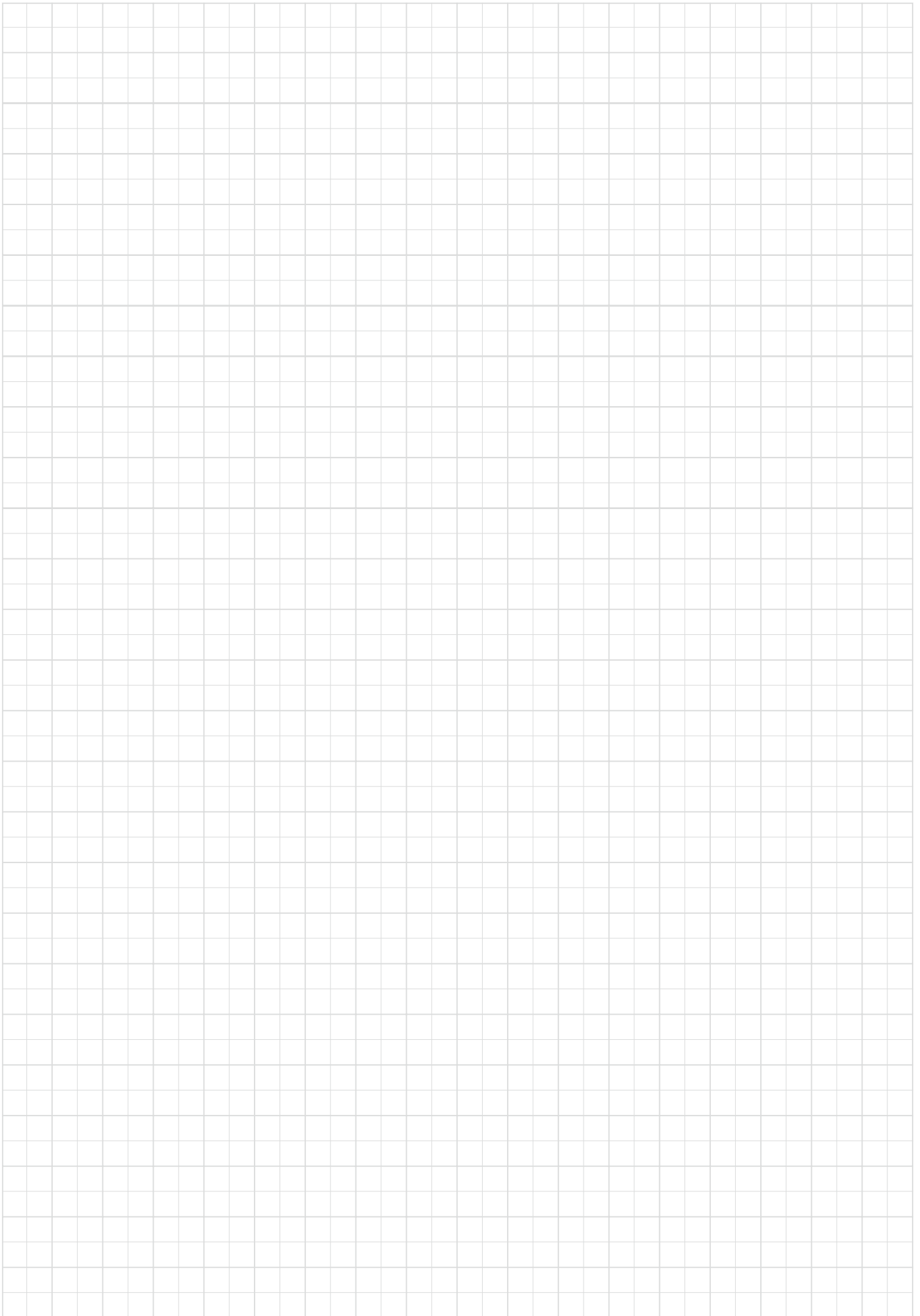

MEMO

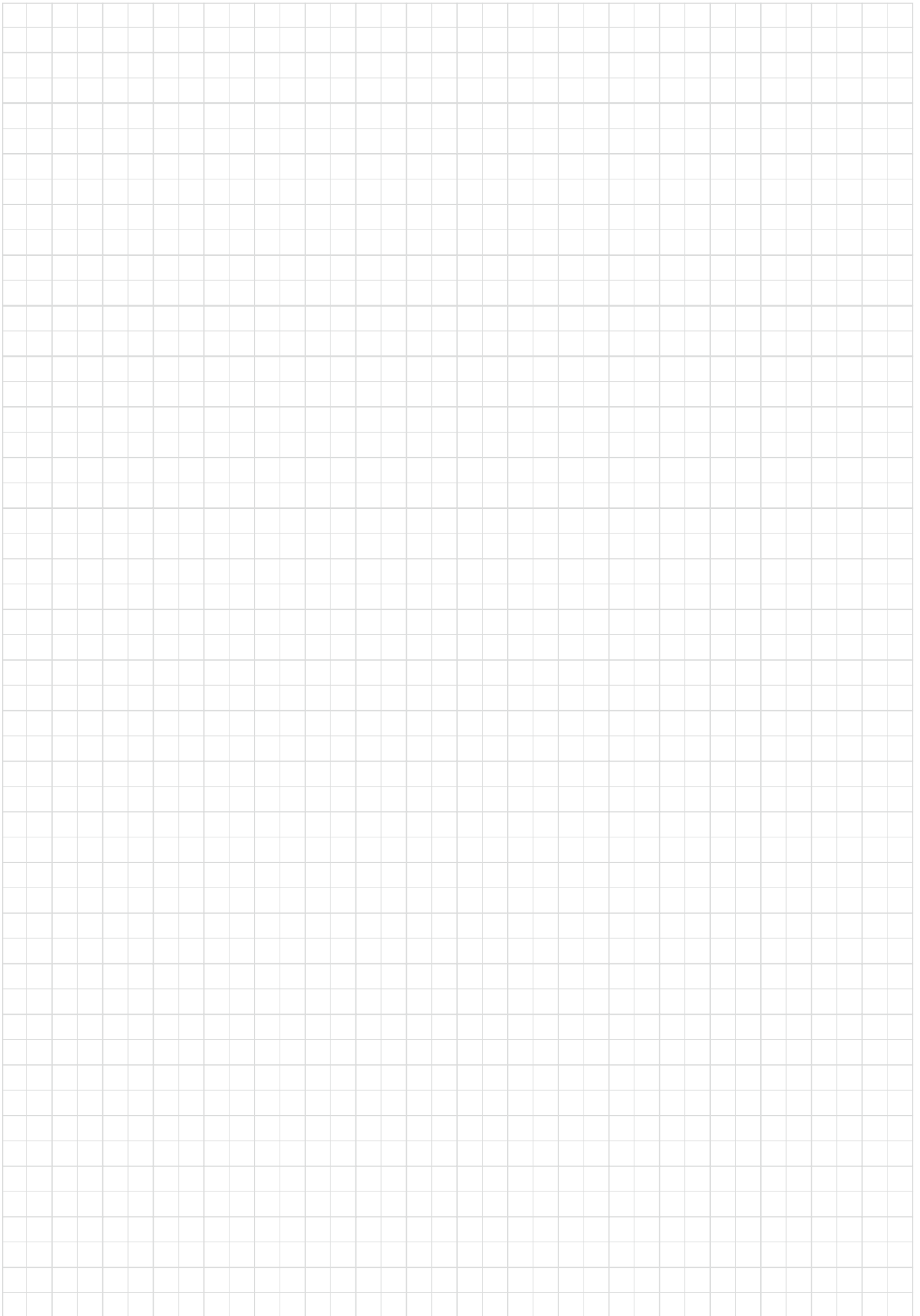

MEMO

A large grid of graph paper, consisting of 30 columns and 40 rows of small squares, intended for taking notes or drawing.

MEMO

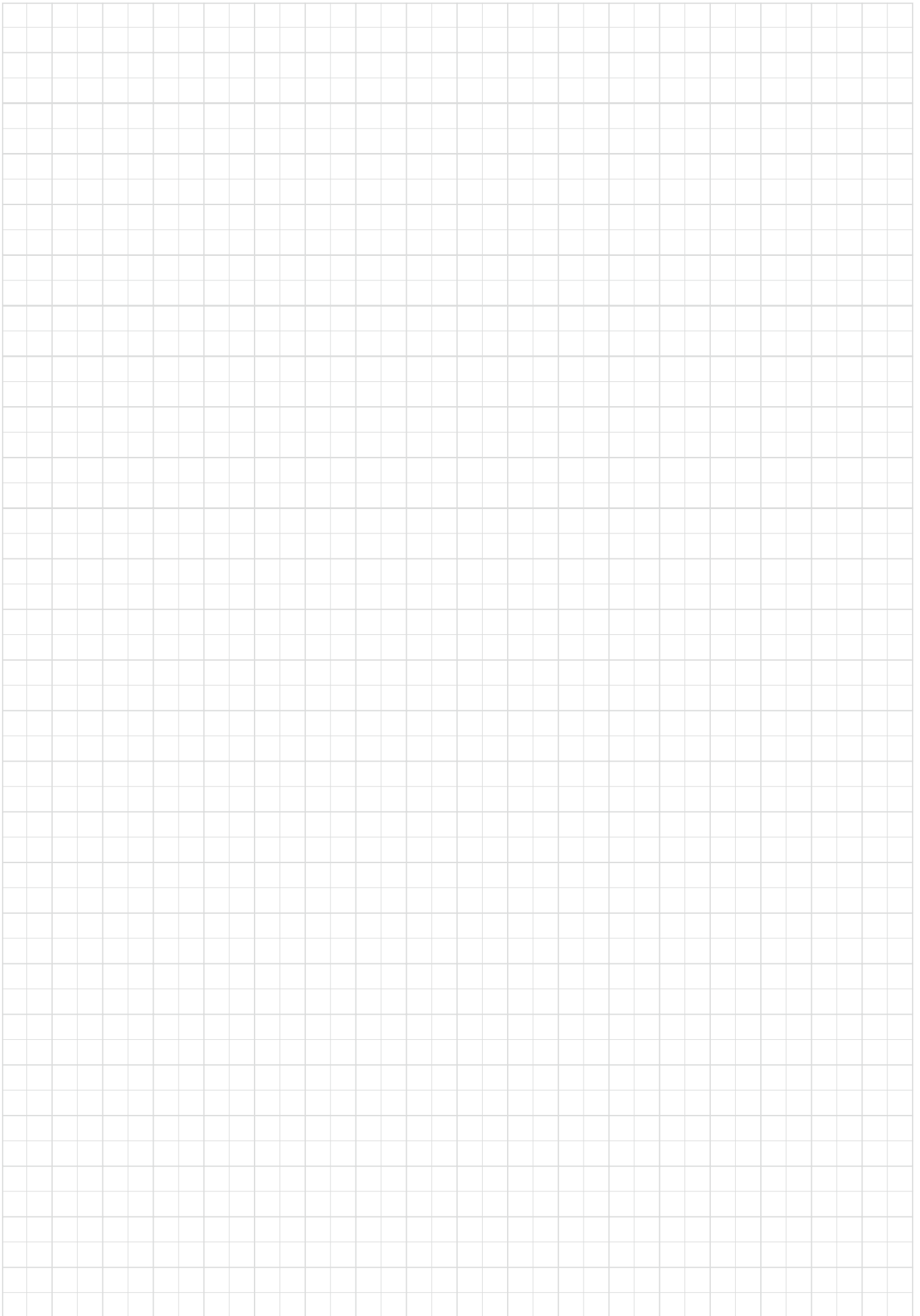

Worldwide Network



Head Office & Production
Facilities in Japan

Tungaloy Corporation Head Office

11-1 Yoshima Kogyodanchi
Iwaki 970-1144 Japan
Phone: +81-246-36-8501
Fax: +81-246-36-8542
tungaloy.com/jp

Iwaki Plant

Products: Cutting Tools

Nagoya Plant

Products: Cutting Tools

Kyushu Plant

Products: CBN
PCD Tools
Deep Hole Drills

Nirasaki Plant

Products: Cutting Tools
Friction Materials (TungFric)
Wear Resistant Tools
Civil Engineering Tools



Sales Channels

Tungaloy-NTK America Inc.

3726 N. Ventura Drive
Arlington Heights
IL 60004, U.S.A.
Phone: +1-888-554-8394
Fax: +1-888-554-8392
tungaloy.com/us

Tungaloy Canada

432 Elgin St. Unit 3, Brantford
Ontario N3S 7P7, Canada
Phone: +1-519-758-5779
Fax: +1-519-758-5791
tungaloy.com/ca

Tungaloy-NTK De Mexico S.A.

C/ Los Arellano 113
Parque Industrial Siglo XXI
Aguascalientes, AGS
Mexico 20290
Phone: +52-449-929-5410
Fax: +52-449-929-5411
tungaloy.com/mx

Tungaloy-NTK do Brasil Ltda.

Avd. Independencia N4158
Residencial Flora
13280-000 Vinhedo
São Paulo, Brazil
Phone: +55-19-38262757
Fax: +55-19-38262757
tungaloy.com/br

Tungaloy-NTK Germany GmbH.

Katzbergstr. 3a
D-40764 Langenfeld, Germany
Phone: +49-2173-90420-0
Fax: +49-2173-90420-19
tungaloy.com/de

Tungaloy France s.a.s

Les Fjords
19 avenue de Norvège
91140 Villebon Sur Yvette, France
Phone: +33-1-6486-4300
Fax: +33-1-6907-7817
tungaloy.com/fr

Tungaloy Italia S.r.l.

Via E. Andolfato 10
I-20126 Milano, Italy
Phone: +39-02-252012-1
Fax: +39-02-252012-65
tungaloy.com/it

Tungaloy Czech s.r.o

Turanka 115
CZ-627 00 Brno, Czech Republic
Phone: +420-532 123 391
Fax: +420-532 123 392
tungaloy.com/cz

Tungaloy Ibérica S.L.

C/Miquel Servet, 43B, Nau 7
Pol. Ind. Bufalvent
ES-08243 Manresa (BCN), Spain
Phone: +34 93 113 1360
tungaloy.com/es

Tungaloy Scandinavia AB

Bultgatan 38, 442 40
Kungälv, Sweden
Phone: +46-462119200
Fax: +46-462119207
tungaloy.com/se

Tungaloy Rus, LLC

Andropova avenue, h.18/7,
11 fl oor, office3, 115432,
Moscow, Russia
Phone: +7-499-683-01-80
Fax: +7-499-683-01-81
tungaloy.com/ru

Tungaloy Polska Sp. z o.o.

ul. Irysowa 1, 55-040 Bielany
Wroclawskie, Poland
Phone: +48 607 907 237
tungaloy.com/pl

Tungaloy-NTK UK Ltd.

Gallan Park, Watling Street,
Cannock, WS110XG, UK
Phone: +44 121 4000 231
Fax: +44 121 270 9694
tungaloy.com/uk

Tungaloy Hungary Kft

Erzsébet királyné útja 125
H-1142 Budapest, Hungary
Phone: +36 1 781-6846
Fax: +36 1 781-6866
tungaloy.com/hu

Tungaloy Turkey

Serifali Mah.bayraktar
Bulvari Kule Sk. No:26
34775 Umraniye / Istanbul / Turkey
Phone: +90 216 540 04 67
Fax: +90 216 540 04 87
tungaloy.com/tr

Tungaloy Benelux b.v.

Tjalk 70
NL-2411 NZ Bodegraven Netherlands
Phone: +31 172 630 420
Fax: +31 172 630 429
tungaloy.com/nl

Tungaloy Croatia

Ulica bana Josipa Jelačića 87,
10430 Samobor, Croatia
Phone: +385 1 3326 604
Fax: +385 1 3327 683
tungaloy.com/hr

Tungaloy Cutting Tool (Shanghai) Co. Ltd.

Rm No 401 No.88 Zhabei
Jiangchang No.3 Rd
Shanghai 200436, China
Phone: +86-21-3632-1880
Fax: +86-21-3621-1918
tungaloy.com/cn

Tungaloy-NTK Cutting Tool (Thailand) Co.,Ltd.

Interlink tower 4th Fl.
1858/5-7 Bangna-Trad Road
km.5 Bangna, Bangna, Bangkok
10260
Thailand
Phone: +66-2-751-5711
Fax: +66-2-751-5715
tungaloy.com/th

Tungaloy Cutting Tools Taiwan Co. Ltd.

9F. No.293, Zhongyang Rd,
Xinzhuang Dist, New Taipei City,
24251 Taiwan
Phone: +886-2-8521-9986
Fax: +886-2-8521-8935
tungaloy.com/tw

Tungaloy Singapore (Pte.), Ltd.

62 Ubi Road 1
#06-11 Oxley BizHub 2
Singapore 408734
Phone: +65-6391-1833
Fax: +65-6299-4557
tungaloy.com/sg

Tungaloy Vietnam

LE04.38, Lexington Residence
67 Mai Chi Tho, Dist. 2,
Ho Chi Minh City, Vietnam
Phone: +84-2837406660
tungaloy.com/vn

Tungaloy India Pvt. Ltd.

One International Center,
Unit # 902-A, 9th Floor,
Tower 1, Senapati Bapat Marg,
Elphinstone Road (West),
Mumbai -400013, India
Phone: +91-22-6124-8803
Fax: +91-22-6124-8899
tungaloy.com/in

Tungaloy Korea Co., Ltd

#1312, Byucksan Digital Valley 5-cha
Beotkot-ro 244, Geumcheon-gu
153-788 Seoul, Korea
Phone: +82-2-2621-6161
Fax: +82-2-6393-8952
tungaloy.com/kr

Tungaloy Malaysia Sdn Bhd

50 K-2, Kelana Mall, Jalan
SS6/14, Kelana Jaya, 47301
Petaling Jaya, Selangor Darul Ehsan
Malaysia
Phone: +603-7805-3222
Fax: +603-7804-8563
tungaloy.com/my

Tungaloy Australia Pty Ltd

Unit 68 1470 Ferntree Gully Road
Knoxfield 3180 Victoria, Australia
Phone: +61-3-9755-8147
Fax: +61-3-9755-6070
tungaloy.com/au

PT. Tungaloy Indonesia

Kompleks Grand Wisata Block AA-10
No.3-5 Cibitung
Bekasi 17510, Indonesia
Phone: +62-21-8261-5808
Fax: +62-21-8261-5809
tungaloy.com/id





11-1 Yoshima Kogyodanchi
Iwaki 970-1144 Japan
tungaloy.com

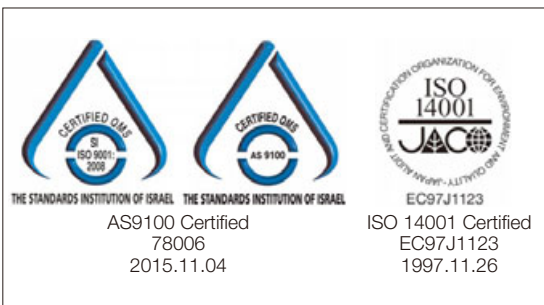

DISTRIBUTED BY: